



DHARAMPETH M. P. DEO MEMORIAL SCIENCE COLLEGE, NAGPUR
INTERNAL QUALITY ASSURANCE CELL (IQAC)

Activity Report

Date: 30/06/2022

Name of Organizing Department or Committee: Computer Science

Name of the activity: Two Days Guest Lecture Series

Suggested CRITERION point if any: V

Date of Activity: 1st and 2nd June 2022

Place of Activity: Online ZOOM Platform

Name of Guest Speaker/s or Judge/s or Chief Guest/s if any: Mrs. Supriya Dani,
Department of BBA, BCCA, R. S. Mundle Arts and Commerce College, Nagpur

Title of the Activity: 2 Days Guest Lecture Series for Certificate Course in Microsoft Excel
for Banking and Accounts

Number of Participants: Day 1: 26, Day 2: 21

Name of the Teacher In-charge / Convener: Mrs. Ruma Kapre

Names of other Committee Members / Staff: NA

OUTCOME of the Activity with respect to mission vision of the institute and or academics:

Two Days Guest Lecture Series was organized for the students of Certificate Course in Excel for Banking and Accounts. It was online activity conducted on ZOOM platform. The Guest Speaker gave lecture on various topics which was from certificate course syllabus. Students learned concepts like generation of MIS report, Role of management accounting, Correlation and Regression, Concept of Data Massaging etc. in two days' lectures. Also they performed practical on these concepts. All students were benefited by the lecture series.

Activity with newspaper coverage if any: NA

Activity data save in PC of: NA



Prof. Pitambar Humane
IQAC Coordinator

CO ORDINATOR
INTERNAL QUALITY ASSURANCE CELL
DHARAMPETH, M. P. DEO MEMORIAL &
SCIENCE COLLEGE, NAGPUR

Mrs. Ruma Kapre
Name & Signature of Teacher In-charge

Dr. Akhilesh Peshwe
Principal

Principal
Dharampeth M.P. Deo Memorial
Science College, Nagpur.

Meeting ID	Topic	Start Time	End Time	User Email	Duration	Participants
85198208333	2 Days Guest Lecture Series for Certificate Course in Microsoft Excel for Banking and Accounts	06-01-2022 15:01	06-01-2022 15:58	akhileshpeshwe@yahoo.com	57	26

Meeting Link: Join Zoom Meeting <https://us02web.zoom.us/j/85198208333?pwd=YXl2UFE2azVjNGxQRjkwTzNuTElkUT09>

Meeting ID: 851 9820 8333

Passcode: 217788

Name (Original Name)	User Email	Total Duration (Minutes)	Guest
Mrs. Ruma Kapre (Dharampeth M. P. Deo Memorial Science College)	akhileshpeshwe@yahoo.com	57	No
Sakshi Hiwarkar		52	Yes
Komal		57	Yes
Soni Rai (Akash Rai)		57	Yes
Mrs. Supriya Dani		58	Yes
Gayatri Uike		57	Yes
Tanu Mohurle		57	Yes
Kajal Sharma		57	Yes
Madhavi		25	Yes
Riddhi Rajkarne		55	Yes
Sana Shete		55	Yes
Oshin Solanke		54	Yes
Nikita lute		55	Yes
Achal Pisode		52	Yes
sonu sarode		7	Yes
Kalash Patel (03767CjU_Osjh8vBdNFSQ_4D1c0a		38	Yes
Sanskriti Atkari		50	Yes
Akanksha Meshram		39	Yes
Ankita Laxman Sonwane		32	Yes
Kalash Patil		12	Yes



Prof. Pitambar Humane
IQAC Coordinator
DHARAMPETH M. P. DEO MEMORIAL & SCIENCE COLLEGE, NAGPUR



Mrs Ruma Kapre
Teacher in-Charge



Dr. Akhilesh Peshwe
Principal
Dharampeth M. P. Deo Memorial
Science College, Nagpur.

Meeting ID	Topic	Start Time	End Time	User Email	Duration (Minutes)	Participants
86548207325	Day 2 2 Days Guest Lecture Series for Certificate Course in Microsoft Excel for Banking and Accounts	06-02-2022 16:28	06-02-2022 17:22	akhileshpeshwe@yahoo.com	54	21

Meeting Link: Join Zoom Meeting <https://us02web.zoom.us/j/86548207325?pwd=eHhORkoyT1gxM0NpaExLTEU3MlI6UT09>
Meeting ID: 865 4820 7325
Passcode: 894681

Name (Original Name)	User Email	Total Duration (Minutes)	Guest
Mrs. Ruma Kapre (Dharampeth M. P. Deo Memorial Science College)	akhileshpeshwe@yahoo.com	54	No
Ashika Thakre		53	Yes
Mrs. Supriya Dani		54	Yes
Gayatri Uike		53	Yes
Sakshi Hiwarkar		18	Yes
Kajal Sharma		52	Yes
Tanu Mohurle		52	Yes
Soni Rai (Akash Rai)		52	Yes
Nikita lute		52	Yes
Sana shete		51	Yes
Komal		49	Yes
Madhavi		20	Yes
Mukul Atram		48	Yes
Kalash Patel		48	Yes
Achal Pisode		44	Yes
sonu sarode		32	Yes
Ankita Laxman Sonwane		13	Yes



Prof. Pitambar Humane

COORDINATOR

**INTERNAL QUALITY ASSURANCE CELL
DHARAMPETH, M. P. DEO MEMORIAL &
SCIENCE COLLEGE, NAGPUR**



Mrs. Ruma Kapre
Teacher In-Charge



Dr. Akhilesh Peshwe
Principal

**Principal
Dharampeth M.P. Deo Memorial
Science College, Nagpur**



DHARAMPETH M. P. DEO MEMORIAL SCIENCE COLLEGE, NAGPUR
INTERNAL QUALITY ASSURANCE CELL (IQAC)

Activity Report

Date: 22-6-2022

Name of Organizing Department or Committee: Value Addition Committee

Name of the activity: Guest Lecture

Suggested CRITERION point if any: 1 & 5

Date of Activity: 21st June 2022

Place of Activity: College, Online Zoom platform

Name of Guest Speaker/s or Judge/s or Chief Guest/s if any: Ms. Anchal Deogade, Physical Education Teacher, J. N. Tata Parsi Girls High School, Nagpur

Title of the Activity: Importance of yoga in daily life

Number of Participants: 41

Name of the Teacher In-charge / Convener: Prof. Varsha Rangari

Names of other Committee Members / Staff: Mrs. Sujata Ali, Dr. R Pashine, Mrs. A. Shiledar, Mrs. Dipti Iyer, Mrs. Priyanka Joshi, Mrs. S. Jawade, Mrs. A. Gadewar, Mrs. M. Zhalke, Mrs. K. Kodape, Mr. H. Kolhe, Dr. R. Kalode.

OUTCOME of the Activity with respect to mission vision of the institute and or academics:

The Value Addition Committee of the college organized a guest lecture online on International Yoga Day, 21st June 2022. Ms. Anchal Deogade, Physical Education Teacher, J. N. Tata Parsi Girls High School, Nagpur was the Guest speaker. She spoke on "Importance of yoga in daily life" and also performed some asanas. The Presidential address was given by Dr. Akhilesh Peshwe. The programme received an overwhelming response by students and staff members. The programme was conducted by Dr. Rahul Kalode, Faculty, Department of Physical Education

Activity with newspaper coverage if any: No

Activity data save in PC of: Prof V. V. Rangari



Note: Kindly share geotag photographs separately along with report on iqacdsc2022@gmail.com

Prof. Pitambar Humane
IQAC Coordinator

IQAC Co-ordinator
Dharampeth M.P. Deo Memorial
Science College, Nagpur-440033

Name & Signature of Teacher In-charge

Dr. Akhilesh Peshwe
Principal

PRINCIPAL
Dharampeth M.P. Deo Memorial
Science College, Nagpur-440033



DHARAMPETH M. P. DEO MEMORIAL SCIENCE COLLEGE, NAGPUR
INTERNAL QUALITY ASSURANCE CELL (IQAC)

Activity Report

Date: 14-7-2022

Name of Organizing Department or Committee: Value Addition Committee

Name of the activity: Guest Lecture

Suggested CRITERION point if any: 1 & 5

Date of Activity: 13-7-2022

Place of Activity: College, APJ Abdul Kalam

Name of Guest Speaker/s or Judge/s or Chief Guest/s if any: Mr. Anil Sambare

Title of the Activity: CELEBRATION of GURU PURNIMA

Number of Participants: 58

Name of the Teacher In-charge / Convener: Prof. Varsha Rangari

Names of other Committee Members / Staff: Mrs. Sujata Ali, Dr. R Pashine, Mrs. A. Shiledar, Mrs. Dipti Iyer, Mrs. Priyanka Joshi, Mrs. S. Jawade, Mrs. A. Gadewar, Mrs. M. Zhalke, Mrs. K. Kodape, Mr. H. Kolhe, Dr. R. Kalode

OUTCOME of the Activity with respect to mission vision of the institute and or academics: The Value Addition Committee of the college celebrated Guru Purnima on 13th July 2022. The Chief Guest of the function was Mr. Anil Sambare, President, Gramayan, Nagpur. Dr. Akhilesh Peshwe, Principal of the College welcomed and felicitated the Chief Guest by offering him a floral bouquet, shawl, shrifal and Memento. In the speech Sambareji explained the importance of Guru Purnima by giving different examples of good works done by different social entrepreneurs. He motivated the students and applied them to be always in learning mode. The Presidential address was given by Dr. Akhilesh Peshwe. The programme received an overwhelming response by students and staff members. The programme was compeered by Dr. Rajesh Pashine, Faculty, Department of Hindi.

Activity with newspaper coverage if any: Yes

Activity data save in PC of: Prof V. V. Rangari



Note: Kindly share geotag photographs separately along with report on iqacdsc2022@gmail.com

Prof. Pitambar Humane

IQAC Coordinator

IQAC Co-coordinator

Dharampeth M.P. Deo Memorial
Science College, Nagpur-440033

Name & Signature of Teacher In-charge

Dr. Akhilesh Peshwe

Principal
PRINCIPAL

Dharampeth M.P. Deo Memorial
Science College, Nagpur-440033



DHARAMPETH M. P. DEO MEMORIAL SCIENCE COLLEGE,
North Ambazari Road, Near Ambazari Lake, Nagpur- 440033

DATA VALIDATION & VERIFICATION (DVV)

Name of the Programme : Guru Purnima
Date of the Programme : 13th July 2022
Name of Chief Guest if any : Mr. Anil Sambare, president, Gramayan.
Name of Guest Speaker if any : Mr. Anil Sambare.

Sr. No.	Name of the Participant	Mobile Number	E-mail Id	Signature
1	Mrs. Priyanka R. Ganorkar	9890211585	joshi.priyanka@gmail.com	Pganorkar
2	U. Dr. P. W. Ambekar	7776899668	paeticofot@gmail.com	P.W.
3	Yogita S. Acharya	9673155177	yogitaacharya7298@gmail.com	Y.S.
4	Mrs. Ashwini Shiledar	9881247267	ashungp2012@gmail.com	A.S.
5	S.K. Hambarde	7972095367	hambarde53@gmail.com	S.K.
6	P.M. Ashtikar	9860078891	pkadipashikar@gmail.com	P.M.
7	A.G. Kadu.	9970765344	Anil@1234@gmail.com	Anil
8	S.B. Choudhari	9977214341	sbchoudhari@gmail.com	S.B.
9	N. U. Barange	9945445282	Nitesh U. Barange	N.U.
10	P. N. Ghandarkar	9096962524	Panduranghandarkar@gmail.com	P.N.

Signature of:

Sangari
Programme In-Charge

Anil Sambare
IQAC Coordinator

CO ORDINATOR
INTERNAL QUALITY ASSURANCE CELL
DHARAMPETH, M. P. DEO MEMORIAL &
SCIENCE COLLEGE, NAGPUR

Chandrasekhar
Principal
Dharampeth M. P. Deo Memorial
Science College, NAGPUR



DHARAMPETH M. P. DEO MEMORIAL SCIENCE COLLEGE,
North Ambazari Road, Near Ambazari Lake, Nagpur-440033

DATA VALIDATION & VERIFICATION (DVV)

Sl No.	Name	Mobile No.	Email	Signature
11	K. D. Mandawar	9096887718		
12	A. B. Mogha	9822343276	abulmogha63@gmail.com	
13	D. P. Hadge	8975541927	hdilip.2010@gmail.com	
14	K. B. Buchunde	9373910651	KamleshbuchundP69@gmail.com	
15	S. D. Maske	9764003855	santoshmaske1972@gmail.com	
16	H. K. Kolhe	8888076353	hkmrjkolhe@gmail.com	
17	S. V. Joshi	9822700619	shahyosies@gmail.com	
18	K. S. Urkudkar	9890811470	kishorurkudkar@gmail.com	
19	D. A. S. Kale	9423408027		
20	D. S. Lulkane	8275282906		
21	P. M. P. P. Dhote	9561015679		
22	A. N. Garkate	7666680423	anilkumbharkate@gmail.com	
23	Mrs. S. S. Pande			
24	Mrs. P. S. Dhoke			
25	Mrs. S. V. Joshi			
26	Archana Ashitkar		archana.ashitkar23@gmail.com	

Signature of:

Program In-charge

IQAC Coordinator

CO ORDINATOR
INTERNAL QUALITY ASSURANCE CELL
DHARAMPETH, M. P. DEO MEMORIAL &
SCIENCE COLLEGE, NAGPUR

Principal

Dharampeth M. P. Deo Memorial
Science College, NAGPUR



DHARAMPETH M. P. DEO MEMORIAL SCIENCE COLLEGE,
North Ambazari Road, Near Ambazari Lake, Nagpur- 440033

DATA VALIDATION & VERIFICATION (DVV)

S. No.	Name	Mobile	Email	Signature
27	Krushali S. Kodape			<u>Ks Kodape</u>
28	Mrs. Shambhavi Holay	8669035314	shambhaviholay18@gmail.com	<u>S. V. Holay</u>
29	Mrs. Ashwini Wamre	9922092595		<u>AW</u>
30	Mrs. A. S. Gundwar	9423110336		<u>ASG</u>
31	Dr. Snehal A. Nazale	9890336139	snehal.nazale16@gmail.com	<u>Snehal</u>
32	S. V. Walde	9404834954		<u>SV</u>
33	Dr. R. D. Kalode	9860552171	sahukalode8@gmail.com	<u>R.D. Kalode</u>
34	Dnyaneshwari S. Waryal	9529716475	dnyaneshwari1893@gmail.com	<u>Waryal</u>
35	Rohini K. Asole	9834703061	rohiniasole@1893mail.com	<u>Asole</u>
36	Neha V. Yadav	9011055444	nvadav2005@gmail.com	<u>NV</u>
37	Sr. V. R. Kathoke	9422880665	vidyakathoke18@gmail.com	<u>V.R. Kathoke</u>

Signature of:
D. S. Gogate
Programme in charge

[Signature]
IQAC Coordinator

CO ORDINATOR
INTERNAL QUALITY ASSURANCE CELL
DHARAMPETH, M. P. DEO MEMORIAL &
SCIENCE COLLEGE, NAGPUR

[Signature]
Principal
Dharampeth M. P. Deo Memorial
Science College, Nagpur



DHARAMPETH M. P. DEO MEMORIAL SCIENCE COLLEGE,
North Ambazari Road, Near Ambazari Lake, Nagpur- 440033

DATA VALIDATION & VERIFICATION (DVV)

SR.No	Name	Mobile	Email	Signature
1.	Yukti J. Dhwadhapade	7058249794	yuktidhwadhapade@gmail.com	
2.	Anjali R. Janbandhu	9356665845	anjalijanbandhu323@gmail.com	
3.	Shraddha K. Bhare	9356944630	bhare.shraddha@gmail.com	
4.	Shrutika M. Nimje	7058503872	nshrutika31@gmail.com	
5.	Shrisha D. Jambhakar	9881759772	Shrishaambhakar16@gmail.com	
6.	Kuntika K. Raut	9307649256	kuntika10@gmail.com	
7.	Palak J. Deshmukh	9011922529	Palakdeshmukh22@gmail.com	
8.	Mahi V. Praadhan	7219166748	mahipraadhan721@gmail.com	
9.	Aakhal R. Singh	9766948149	krishtu.singh@iitd.com	
10.	Rahul S. Dehariya	9634252269	rdehariya123@gmail.com	
11.	Harsh S. Mok	9764193552	harshsmok28@gmail.com	
12.	Akshad Gajbhiye	9179196140	akshadgajbhiye4@gmail.com	
13.	Harshik Humane	7907914785	harshikhumane1@gmail.com	
14.	Aditya R. Mutha	9595729551	AdityaR@gmail.com	
15.	Aman R. Patel	8668489823	308421548824@gmail.com	
16.	Sejal D. Wankhale	7387990077	sejalwankhale2@gmail.com	

Signature of:

Program In-charge

IQAC Coordinator

CO ORDINATOR
INTERNAL QUALITY ASSURANCE CELL
DHARAMPETH, M. P. DEO MEMORIAL &
SCIENCE COLLEGE, NAGPUR

Principal
Dharampeth M. P. Deo Memorial
Science College, NAGPUR



DHARAMPETH M. P. DEO MEMORIAL SCIENCE COLLEGE,
North Ambazari Road, Near Ambazari Lake, Nagpur- 440033

DATA VALIDATION & VERIFICATION (DVV)

Sl. No.	Name	Mobile No.	Email	Signature
17.	Md. Mo'in Rahman	9011407337	shakeza1234.com@gmail.com	Md. Mo'in Rahman
18.	Kanak Biswas Rinki Dubey	8208787976 7498685798	kanakbiswas294@gmail.com Dubeyrinki83@gmail	Kanaka Biswas Rinki Dubey
19.	Ritul Kauri	8446063936	ritul.koria@gmail.com	Ritul
20.	Palyanshu Kumar	7667294124	Palyanshukumar 0766726210@gmail.com	Kumara
21.	Prashantjeet R. Gajble Vaishnavi W. Purnake	8080512543 9579768645	Prashantjeetgajble@gmail.com Vaishnavi.Purnake@gmail.com	Prashantjeet Vaishnavi
22.	Tanushka R Meshram	8830855412	Tanushkameshram330@gmail.com	T. Meshram
23.	Neha M. Bakhare	9403008113	nehama2002@gmail.com	Neha
24.	Ayush S. Yele	8805265978	Yeleayush@gmail.com	Ayush
25.	Sameet Y. Wagh	8830796088	Sameetyw11@gmail.com	Sameet
26.	Palash R. Ninawe	9130448151	Palashnawar2005@gmail.com	Palash
27.	Aditi A. Wagh	7058487922	Waghaditi25@gmail.com	Aditi
28.	Riddhi D. Bhure	9322017087	riddhibhure28@gmail.com	Riddhi

Signature of:

[Signature]
Programme In-charge

[Signature]
IQAC Coordinator

CO ORDINATOR
INTERNAL QUALITY ASSURANCE CELL
DHARAMPETH, M. P. DEO MEMORIAL &
SCIENCE COLLEGE, NAGPUR

[Signature]
Principal
Dharampeth M. P. Deo Memorial
Science College, Nagpur



DHARAMPETH M. P. DEO MEMORIAL SCIENCE COLLEGE,
North Ambazari Road, Near Ambazari Lake, Nagpur-440033

DATA VALIDATION & VERIFICATION (DVV)

Junior College Staff

39) Mrs. Sujata Ali I. Ali
39) डॉ. राजेंद्र राजकुमार पशीने (आर्याभट्ट)

Senior College Staff

40) Prof. Mrs. S. K. Ubale ^{no}
39) Prof. Mrs. V. V. Rangari ^{Q.}

Signature of:

Rangari
Programme In-charge

[Signature]

IQAC Coordinator
CO ORDINATOR
INTERNAL QUALITY ASSURANCE CELL
DHARAMPETH M. P. DEO MEMORIAL &
SCIENCE COLLEGE, NAGPUR

[Signature]

Principal
Principal
Dharampeth M. P. Deo Memorial
Science College, NAGPUR



Activity Report

Date: 30.7.22

Name of Organizing Department or Committee: Home Science

Name of the activity: Career Guidance from Alumni 21 passed out Students

Suggested CRITERION point if any: V

Date of Activity: 18.7.22

Place of Activity: Department of Home Science

Name of Guest Speaker/s or Judge/s or Chief Guest/s if any: Alumni of the College

Ms Shambhavi AlsI & Ms Astha Mendhe

Title of the Activity: _Interface with the Students & Career information in PG in Clinical Nutrition.

Number of Participants: 15 Students

Name of the Teacher In-charge / Convener: Mrs M M Deshpande.

Names of other Committee Members / Staff:

OUTCOME of the Activity with respect to mission vision of the institute and or academics:

Career decision & information with interaction with pass Out Students helps to Understand avenues For Career & options for decision making which can be seeked other wise also, but direct interface with Senior Student can be useful & meaningful . Keeping with the need based Curriculum with Vocational importance.

Activity with newspaper coverage if any: No

Activity data save in PC of: M.M.Deshpande

Note: Kindly share geotag photographs separately along with report on iqacdsc2022@gmail.com



CO ORDINATOR
INTERNAL QUALITY ASSURANCE CELL
DHARAMPETH M. P. DEO MEMORIAL
SCIENCE COLLEGE, NAGPUR

Prof. Pitambar Humane
IQAC Coordinator

Name & Signature of Teacher In-charge

Dr. Akhilesh Peshwe

Principal
Dharampeth M. P. Deo Memorial
Science College, Nagpur-440133



DHARAMPETH M. P. DEO MEMORIAL SCIENCE COLLEGE,
North Ambazari Road, Near Ambazari Lake, Nagpur- 440033

DATA VALIDATION & VERIFICATION (DVV)

Name of the Programme : Interface with the Student Alumni for Career Guidance
Date of the Programme : 22-07-22
Name of Chief Guest if any : Shambhavi Aloi, Alumni of H.Sc Department
Name of Guest Speaker if any : _____

Sr. No.	Name of the Participant	Mobile Number	E-mail Id	Signature
1.	SUSHMITA MALLICK	9887916560	sushmitta00@gmail.com	
2.	RIYA SHEREKAR	7249070278	sherekar.riya@gmail.com	
3.	VANSHIKHA TODASE	7498118926	vanshikha@gmail.com	
4.	VAISHNAVI UPASAK	9975287431	upatak.vaishnavi@gmail.com	
5.	POOJA CHUTE	9552381386	lazmichute123@gmail.com	
6.	AARTI RAUT			
7.	ANANYA MEGHRE	9284834639	ananyameghre@gmail.com	
8.	RENUKA RAUT	8855942285	xautrenuka85@gmail.com	
9.	MAYURI MALI			
10.	MAHIMA WANKHADE	7821883251	mahimawankhade7@gmail.com	

Signature of:
Programme In-charge

IQAC Coordinator
CO ORDINATOR
INTERNAL QUALITY ASSURANCE CELL
DHARAMPETH, M. P. DEO MEMORIAL &
SCIENCE COLLEGE, NAGPUR

Principal
PRINCIPAL
Dharampeth M. P. Deo Memorial
Science College, Nagpur-440033



DHARAMPETH M. P. DEO MEMORIAL SCIENCE COLLEGE,
North Ambazari Road, Near Ambazari Lake, Nagpur- 440033

DATA VALIDATION & VERIFICATION (DVV)

11.	PAYAL GHUMATKAR			
12.	VAISHNAVI BAHADURE	9784679244	Vaishnavi bahadure su@ gm	Vaishnavi
13.	AROHI RAMTEKE	8983345716	Aashiramtekei@gmail	Ramteke
14.	FRNALI RAUT			
15.	SAKSHI THOSAR			
16.	ANJALI SONI			

Signature of:

N. Chandrasekar
Programme In-charge

[Handwritten Signature]

IQAC Coordinator
CO ORDINATOR
INTERNAL QUALITY ASSURANCE CELL
DHARAMPETH, M. P. DEO MEMORIAL &
SCIENCE COLLEGE, NAGPUR

[Handwritten Signature]
Principal
PRINCIPAL

Dharampeth M. P. Deo Memorial
Science College, Nagpur-440033



DHARAMPETH M.P. DEO MEMORIAL SCIENCE COLLEGE, NAGPUR

ROTARACT CLUB OF DMPDSVM

Activity Report

Name of Organizing Department or Committee: Rotaract Club

Name of the activity: Letterhead Exchange Pune

Suggested CRITERION point if any: Criterion III & Criterion V

Date of Activity: 20 July 2022

Place of Activity: Letterhead Exchange Pune

Name of Guest Speaker/s or Judge/s or Chief Guest/s if any: Nil

Title of the Activity: Letterhead Exchange Pune

Number of Participants: 1

Name of the Teacher In-charge/Convener: Dr. Mrs. Shraddha Deshpande

Names of other Committee Members /Staff: Rotary Club of Nagpur Downtown & Rotaract Club Members.

OUTCOME of the Activity with respect to mission vision of the institute and or academics:
The Letterhead exchange will help the Rotaractors to conduct the activities in collaboration with other Rotaract Clubs.

Activity with news paper coverage if any: Yes

Activity data save in PC of: Department of English



Prof. Pitambar Humane
IQAC Coordinator

CO ORDINATOR
INTERNAL QUALITY ASSURANCE CELL
DHARAMPETH, M. P. DEO MEMORIAL &
SCIENCE COLLEGE, NAGPUR

Dr. Mrs. Shraddha Deshpande
Teacher In-charge

Dr. Akhlesh Peshwe
Principal
Dharampeth M.P. Deo Memorial
Science College, Nagpur.



DHARAMPETH M. P. DEO MEMORIAL SCIENCE COLLEGE, NAGPUR
INTERNAL QUALITY ASSURANCE CELL (IQAC)

Activity Report

Date: 30.7.22

Name of Organizing Department or Committee: Dharampeth M PDeo Memorial Science College to commemorate RTMNU Kaushalya Diwas

Name of the activity: "Kala Pradarshan 22_" -Department of Home Science

Suggested CRITERION point if any: II

Date of Activity: 23.7.22.

Place of Activity: Department of Home Science Building, II floor

Name of Guest Speaker/s or Judge/s or Chief Guest/s if any:

Dr Nishikant Raut Director, Department of Life Long Learning & Extension Education to Grace the Occasion,

Inaugurated by the hands of Dr P Humne IQAC Coordinator & Prof Dr Seema Ubale Madam, Head Department of Physics, Head Department of Statistics

Title of the Activity: Kaushalya Kala Pradarshani

Number of Participants: (Students of Semester V of Home Science) 21 participant

Name of the Teacher In-charge / Convener: Entire Faculty Members of Home Science

Names of other Committee Members / Staff:

OUTCOME of the Activity with respect to mission vision of the institute and or academics:

Creativity in Skills Learnt, Entrepreneur Skills,

Social Participation & group Interaction & Interpersonal Skills through Visitor Interaction,

Earn While Learn

Activity with newspaper coverage if any: Live Nagpur

Activity data save in PC of: Mrs M M Deshpande.

Note: Kindly share geotag photographs separately along with report on iqacdsc2022@gmail.com



COORDINATOR
Prof. Pitambar Humane
IQAC Coordinator
DHARAMPETH M. P. DEO MEMORIAL &
SCIENCE COLLEGE, NAGPUR

Name & Signature of Teacher In-charge
Dr. Akhilesh Peshwe
Principal
DHARAMPETH M. P. DEO MEMORIAL
SCIENCE COLLEGE, NAGPUR-440033



Dharampeth Education Society's
**DHARAMPETH M. P. DEO MEMORIAL
SCIENCE COLLEGE**

Near Ambazari Lake, North Ambazari Road, Nagpur 440 033 (M.S.)
Contact : +91 712 2241372 / 2241490 Fax +91 712 2241125
www.dharampethscience.com
NAAC Accredited - A grade (3.01)

DR. AKHILESH V. PESHWE
M.A., M.Ed. (DSE), M.S., Ph.D.
PRINCIPAL

Contact : +91 94223 13334
Email : principal_dsc@rediffmail.com

Letter No. : DSC/SR/IR/_____

Date : _____

**DHARAMPETH M P DEO MEMORIAL SCIENCE COLLEGE ,NAGPUR
COMMEMORATE KAUSHALYA DIWAS**

The Students of Home Science arranged an Exhibition titled "Kaushalya Pradarshini 22nd on 23rd" to commemorate Kaushalya Diwas. Students displayed Wonderful & Skill based articles prepared by them. Dr. Nishikant Raut Director, Department of Life Long Education & Extension of Rastra Sant Tukdoji Maharaj Nagpur University was invited on this Occasion. Dr Raut Sir appreciated the work of Students & Spoke on the Importance of Skill building amongst the Students. Dr Akhilesh Peshwe Principal ,motivated the Students of Home Science with his motivational words .Dr Nishikant Raut Sir Spoke on the Occasion and guided the Students.

Dr Pitambar Humne, IQAC Coordinator & Prof Seema Ubale, Head of Department of Physics Inaugrated this Event . They were very curious & eager to understand what the Students learnt. They Put up many quarries for the Students which they Students could answer well. The students were appreciated for their work.

Amongt the dignitaries who visited the exhibition were Prof Hardas Sir, Joshi Sir, Mrs Pallavi Shyamkule ,Nagar Sewika and Alumni of Home Science Department & all the Teachers & Staff of the College. The Success of this Event was due to the effort taken by the Students of Semester V 2022 Batch. . It was definitely a ride of Skill avenues in the Subject of Home Science. Students participated & Worked enthusiastically & enjoyed the event thoroughly.

Special to mention are the students viz Sushmita Mallick, Riya Sherekar, Mayuri Mali ,Vaunshika Todase, Vaishnavi Upasak, Pooja Chute, Arti Raut, Arohi Ramteke ,Saakshi Thosar, Ananya Meghare ,Payal Ghumathkar who have extensively worked to make this experience worth a mention. The Entire Staff visited the art Exhibition.

ndea-pande
Head, Department of Home Science
Dharampeth M.P. Deo Memorial
Science College, Nagpur



DHARAMPETH M. P. DEO MEMORIAL SCIENCE COLLEGE,
North Ambazari Road, Near Ambazari Lake, Nagpur-440022

DATA VALIDATION & VERIFICATION (DW)

Name of the Programme

"Kala Paradarshan 22" Department of Home Science

Date of the Programme

23.7.22

Name of Chief Guest / Jury

Dr. Nishkant Raut

Name of Guest Speaker / Jury

Sr. No.	Name of the Participant	Mobile Number	E-mail Id	Signature
1]	Mahima Wankhede	7821883251	wankhede mahi@ca Mahi	
2]	Sakshi Thorate	8177911360	Sakshithorate620@gmail.com	Sakshi
3]	Ananya Meghne	92848334439	ananyaMeghne@gmail.com	Ananya
4]	Pooja Chhatrkar	9067560926	bhagyshriChhatrkar-gmail.com	Pooja
5]	Vaishnavi Babaduse	9286679246	VaishnaviBabaduse@gmail.com	Vaish
6]	Vaishnavi Upasak	9975287431	Upasakvaishnavi@gmail.com	Upasak

Nishpande
Head, Department of Home Science
Dharampeth M. P. Deo Memorial
Science College, Nagpur

Nishkant
CO ORDINATOR
INTERNAL QUALITY ASSURANCE CELL
DHARAMPETH, M. P. DEO MEMORIAL &
SCIENCE COLLEGE, NAGPUR

Prakash
PRINCIPAL
DHARAMPETH M. P. DEO
MEMORIAL SCIENCE COLLEGE
NAGPUR



DHARAMPETH M. P. DEO MEMORIAL SCIENCE COLLEGE,
North Ambazari Road, Near Ambazari Lake, Nagpur-440033

DATA VALIDATION & VERIFICATION (D.V.V)

7) Shrushti Patekar	7387067403	shrushtipatekar@gmail.com	Shrushti
8) Vaishnavi Pradhan	9763169560	Pradhanvaishnavi155@gmail.com	Vaishnavi
9) Nisha Chormare	8669586501	nishachormare50@gmail.com	Nisha
10) Archita d. Madke	9975034151	madkearchita@gmail.com	Archita
11) Pallavi B. Kotre	8459777008	PRADIP513@gmail.com	Pallavi
12) Syota Kaware	9175451202	syotakaware1@gmail.com	Syota
13) Pranali Ghogarkar	9209079427	Pranali02gh@gmail.com	Pranali
14) Bhagyashree S. Ambule	9359139068	cimbuleb66@gmail.com	Ambule
15) Ojasvi M. Wankhede	8767699751	wankhedv@gmail.com	Ojasvi
16) Aveni S. Shenwai	9096507459	Avanishenwai@gmail.com	Aveni
17) Tannu S. Korde	7841984410	kordefannu139@gmail.com	Tannu
18) Kimaya N. Kale	8866073732	kimoyakale003@gmail.com	Kimaya
19) Priyanka K. Khawshi	9763617224	Priyankhawshi3@gmail.com	Priyanka
20) Karina T. Diwe	9284257798	cuverkarina2@gmail.com	Karina
21) Poojita A. Wankhede	8459413595	Poojitawankhede148@gmail.com	Poojita

M. Deshpande

Head, Department of Home Science
Dharampeth M. P. Deo Memorial
Science College, Nagpur

[Signature]

DATA VALIDATION

[Signature]

PRINCIPAL
DHARAMPETH M. P. DEO
MEMORIAL SCIENCE COLLEGE
NAGPUR



KAUSHALYA KALA PRADARSHANI

2022

Invitation for all teachers of the college, alumni, nonteaching staff & students

We are extremely happy to invite you to visit Kala pradarshani titled "kaushalya 22"

Venue : 2nd floor Dept of Home Science

Time : 11.30 am.

Date: 23/07/22

Awaiting to welcome you
Entire faculty & students of Home Science.

N. S. S. S.
Head, Department of Home Science
Dharampeth, M.P. Deo Memorial Home Science College, Nagpur



DHARAMPETH M.P. DEO MEMORIAL SCIENCE COLLEGE, NAGPUR

ROTARACT CLUB OF DMPDSVM

Activity Report

Date: 30/07/2022

Name of Organizing Department or Committee: Rotaract Club

Name of the activity: Tree Plantation World Conservation Day

Suggested CRITERION point if any: Criterion III & Criterion V

Date of Activity: 28th July 2022

Place of Activity: Home Science Department

Name of Guest Speaker/s or Judge /or Chief Guest/s if any: Dr. Mrs. Sujata Godbole

Title of the Activity: Green is Gold: One step towards Green Future

Number of Participants: 15

Name of the Teacher In-charge/Convener: Dr. Mrs. Shraddha Deshpande

Names of other Committee Members/Staff: Nil

OUTCOME of the Activity with respect to mission vision of the institute and or academics:

Students celebrated World Conservation Day under the theme Green is Gold to create awareness regarding conservation of nature through tree plantation.

Activity with news paper coverage if any: Nil

Activity data save in PC of: Department of English



Prof. Pitambar Humane

IQAC Coordinator

INTERNAL QUALITY ASSURANCE CELL
DHARAMPETH, M. P. DEO MEMORIAL &
SCIENCE COLLEGE, NAGPUR

Dr. Mrs. Shraddha Deshpande
Teacher In-charge

Dr. Akhilesh Peshwe
Principal
Dharampeth M.P. Deo Memorial
Science College, Nagpur.



DHARAMPETH M.P.DEO MEMORIAL SCIENCE COLLEGE, NAGPUR

ROTARACT CLUB 22-23

World Conservation Day (Tree Plantation)

28th July 2022

Rotary.org Link

Instagram Link

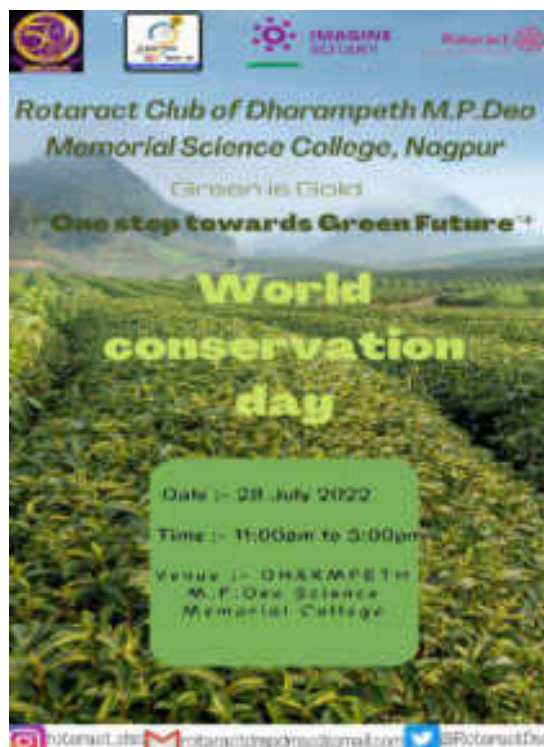



DHARAMPETH M. P. DEO MEMORIAL SCIENCE COLLEGE,
North Ambazari Road, Near Ambazari Lake, Nagpur- 440033

DATA VALIDATION & VERIFICATION (DVV)

Name of the Programme : World Nature Conservation Day (Green is Gold)
Date of the Programme : 28 July 2022
Name of Chief Guest if any : Dr. Mrs. Sujata Godbole
Name of Guest Speaker if any : -

Sr. No.	Name of the Participant	Mobile Number	E-mail Id	Signature
1.	Poojwal Bhayare	8010434634	poojwalb738@gmail.com	
2.	Ananya Motghare	7219218955	ananya.motghare1802@gmail.com	
3.	Nupur Sharma	9392042259	nupursharma258@gmail.com	
4.	Sania Raza	8975726700	midhatsania@gmail.com	
5.	Renuka Lande	7719951401	gargihodge@gmail.com	
6.	Vedant Baxy	8530455796	vedantbaxy2003@gmail.com	
7.	Gargi Hodge	7972076671	gargihodge@gmail.com	
8.	Dharmapati Lale	9975037356	dharmapatilraj@gmail.com	
9.	Harsh Kodape	9604677672	harshkodape008@gmail.com	
10.	Sanchita Patil	7218079074	sanchitapatil2003@gmail.com	

Signature of:

Programme In-charge

CO ORDINATOR
IQAC Coordinator
INTERNAL QUALITY IMPROVEMENT CELL
DHARAMPETH, M. P. DEO MEMORIAL &
SCIENCE COLLEGE, NAGPUR

Principal
Dharampeth M.P. Deo Memorial
Science College, Nagpur



DHARAMPETH M. P. DEO MEMORIAL SCIENCE COLLEGE,
North Ambazari Road, Near Ambazari Lake, Nagpur- 440033

DATA VALIDATION & VERIFICATION (DVV)

11.	Tejas Polanke	7030730670	tejaspolanke202@gmail.com	Tejas
12.	Avishek A. Banod	782084788	avishekbanod02@gmail.com	Ave
13.	Vaishnavi V. Gadge	9022976449	gadgavaishnavi00@gmail.com	Vaishnavi
14.	Sahil Singh	7258868502	sahilsingh00@gmail.com	Sahil
15.	Hanshad warthi	7414993275	hanshadwarthi9592@gmail.com	Hanshad

Signature of:

Programme In-charge

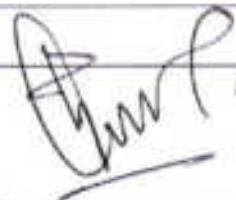

CO ORDINATOR
INTERNAL QUALITY ASSURANCE CELL
DHARAMPETH, M. P. DEO MEMORIAL &
SCIENCE COLLEGE, NAGPUR



Principal
Dharampeth M.P. Deo Memorial
Science College, Nagpur.



DHARAMPETH M. P. DEO MEMORIAL SCIENCE COLLEGE, NAGPUR
INTERNAL QUALITY ASSURANCE CELL (IQAC)

Activity Report

Date: 30th Aug., 2022

Name of Organizing Department or Committee: NATIONAL SERVICE SCHEME (NSS)

Name of the activity: Tree Plantation

Suggested CRITERION point if any: CRITERION-III

Date of Activity: 3rd August, 2022

Place of Activity: College Campus

Name of Guest Speaker/s or Judge/s or Chief Guest/s if any:

Title of the Activity: Tree Plantation Programme

Number of Participants: 25

Name of the Teacher In-charge / Convener: Prof. Pitambar Humane

Names of other Committee Members / Staff: Dr. Nitin Gaikwad, Prof. Mrs. Varsha Rangari, Dr. Mrs. Shraddha Deshpande, Dr. Mrs. Kirti Paturkar, Mrs. Ruma Kapre

OUTCOME of the Activity with respect to mission vision of the institute and or academics:

Many Trees were planted in College Premises during this activity. This activity carried out every year on occasion of *Samajik Janiv Diwas*, foundation day of the society. It helps to create an awareness about tree plantation and its need and role in conservation of environment among the students. On this day especially Ashoka trees were planted in the college premises. President and Secretary were present and the plants were planted at the hands of Dr. Prafull Sabale, RIM Nagpur University, Nagpur. Dr. Akhilesh Peshwer, Principal and Pitambar Humane, IQAC Coordinator along with teaching and non-teaching staff of the college were also present during this occasion.

Activity with newspaper coverage if any:

Activity data save in PC of: Prof. Pitambar Humane's Laptop



Name & Signature of Teacher In-charge

Prof. Pitambar Humane
IQAC Coordinator

CO ORDINATOR
INTERNAL QUALITY ASSURANCE CELL
DHARAMPETH, M. P. DEO MEMORIAL &
SCIENCE COLLEGE, NAGPUR

Dr. Akhilesh Peshwe
Principal
Dharampeth M.P. Deo Memorial
Science College, Nagpur.



DHARAMPETH M. P. DEO MEMORIAL SCIENCE COLLEGE, NAGPUR

NATIONAL SERVICE SCHEME (NSS)

Tree Plantation Programme

3rd Aug., 2022

Sr. No.	Name of the Student	email id	Mobile Number
1	PRITAM SURENDRA KATWE	pritamkatwe655@gmail.com	8010793204
2	AAKANSHA KAMAL KHOBRAGADE	aakanshakhobragade7@gmail.com	7972228707
3	RENUKA DILIP RAUT	rautrenuka85@gmail.com	8855972285
4	ISHITA NILESH DESHPANDE	ishitandeshpande21004@gmail.com	9130091540
5	ASHALESHA RAJESH KHADGI	khadgirupali25@gmail.com	8830414264
6	SALONI DYANESHWAR DONGRE	dongresaloni0@gmail.com	99233 61488
7	SAKSHI AJAY MISHRA	smishra39683@gmail.com	91587 88969
8	Janhvi Mahadeo Joge	janhvijoge08@gmail.com	7385060871
9	MEENAL AMRESH CHOUDHARY	meenalchoudhary2004@gmail.com	9529014604
10	JAGRUTI GANESH FULKAWAR	jagrutifulkawar@gmail.com	8767911307
11	Vineet singh	singhvineet78524@gmail.com	8552987293
12	VEDANT ONKAR UMRETKAR	umretkarvedant@gmail.com	9049932753
13	TUSHAL RUPKUMAR ACHARE	acharetushal5@gmail.com	9075995617
14	Tejas Ramesh dongre	tejasdongre453@gmail.com	9322578918
15	ANKIT RAJKUMAR PATEL	ankitpatel797275@gmail.com	9970905638
16	KASHISH KAMALKUMAR BISEN	kashishbisen05@gmail.com	7887886117
17	PRANALI YASHWANT CHAVHARE	pranalichavhare69@gmail.com	9699654562
18	SAMIKSHA AMRUT PANCHBUDHE	samikshapanchbudhe363@gmail.com	9763075890
19	KHUS huHI PALI	palikhushi4@gmail.com	8767607224
20	KHUSHBU RAJIV PALI	palikhushbu59@gmail.com	8459565214
21	DHANASHREE NEWARE	dhanashrineware786@gmail.com	9359909913
22	Anjali Manhattan singh	anjalisiseenghas1524541@gmail.com	8317296731
23	TANU. AJAY. SINGH	tanusingh63492@gmail.com	8806355808
24	SIDDHI BHAGWAT TIWARI	siddhitiwari0721@gmail.com	8087143696
25	ARYA RAJENDRA BHAKTE	aryabhakte744@gmail.com	7447568915

Prof. Pitambar Humane

Program Officer, NSS



Activity Report

Date: 3rd Aug 2022

Name of Organizing Department or Committee: Value Addition Committee

Name of the activity: Foundation Day

Suggested CRITERION point if any: Suggested criteria-V and VII

Date of Activity: 3rd August 2022

Place of Activity: Late shri Vinayakrao Phatak Hall,

Name of Guest Speaker/s or Judge/s or Chief Guest/s if any: Dr.Prafulla Sable, Director ,
Board of Examination and Evaluation, RTM, Nagpur University, Nagpur

Title of the Activity: SAMAJIK JAANIV DIWAS

Number of Participants: Most of the Teaching and Non Teaching staff of the college and students

Name of the Teacher In-charge / Convener: Dr. Varsha Rangari

Names of other Committee Members / Staff: Mrs. Sujata Ali, Mrs. Ashwini Shiledar, Mrs. Iyer , Mr. Kalode, Mrs. Priyanka Ganorkar

OUTCOME of the Activity with respect to mission vision of the institute and or academics:

The Value Addition Committee of the college celebrated 'The Foundation Day' of the college as Samajik Jaaniv Diwas on **3rd August, 2022**. The programme commenced with a song recital by Miss. Neha Labhe and Group. The Chief Guest of the function was Dr.Prafulla Sable, Director , Board of Examination and Evaluation, RTM, Nagpur University, Nagpur and Shri. Ratnakar Kekatpure, Secretary, DES, was the Guest of Honour. On this day the bust of the founder late. Shri. Bhikaji Appasaheb Phatak, who played an instrumental role in laying the foundation of this glorious society was unveiled. The college felicitated Dr.Ravi Hardas, Principal , Natraj Academy and Mr.Moutik Kate , the sculptor, for doing a wonderful job of making the graceful sculpture. A booklet specially prepared to pay tributes to our founder, Dharampeth Education Society, Late. Shri, Bhikaji Appasaheb Phatak, entitled 'The Unsung Hero of 1947' was released at the hands of the dignitaries. It was followed by Foundation Day Song by Mrs. Priyanka Ganorkar, Mrs. Khushali Kodape & Mrs. Ashwini Shiledar along with their troupe. Vote of thanks was given by Mrs. Sujata Ali who also compered the programme. The presidential address was given by Adv. Shri. Ullhas Aurangabadker , President , Dharampeth Education Society. Introductory remarks were given by Dr. Akhilesh Peshwe, IQAC Co-ordinator & Hod. Botany, Prof. Pitambar Humane, Convenor & Hod Electronics, Prof. Mrs. Varsha Rangari, Vice Principal Jr. College, Mrs. Vinaya Kashikar, Supervisor Jr. College, Mrs Shobha Zalke, respected colleagues, administrative staff and students were present on the occasion.



Activity data save in PC of: Dr. V. V. Rangari

Note: Kindly share geotag photographs separately along with report on iqacpsc2022@gmail.com

Prof. Pitambar Humane
IQAC Coordinator

CO ORDINATOR
INTERNAL QUALITY ASSURANCE CELL
DHARAMPETH, M. P. DEO MEMORIAL &
SCIENCE COLLEGE, NAGPUR

Dr. Varsha V. Rangari
Name & Signature of Teacher In-charge

Dr. Akhilesh Peshwe
Principal

Principal
Dharampeth M.P. Deo Memorial
Science College, NAGPUR



DHARAMPETH M. P. DEO MEMORIAL SCIENCE COLLEGE,
North Ambazari Road, Near Ambazari Lake, Nagpur- 440033

DATA VALIDATION & VERIFICATION (DVV)

Name of the Programme : foundation Day - Samajik Janiv Divas.
Date of the Programme : 3rd August 2022
Name of Chief Guest if any : -
Name of Guest Speaker if any : -

Sr. No.	Name of the Participant	Mobile Number	E-mail Id	Signature
1)	Urmati D Jadhav	9145443760	Urmati.jadhav@ngs nagpur.org	
2)	Prachi S. Parihare	8390746842	Prachiparihare9604@ gmail.com	
3)	Palak J. Deshmukh	9011982529	palakdeshmukh197@ gmail.com	
4)	Dr. Rahul Kalode	9860552171		
5)	Mrs. P. R. Ganekar	9890211585	johitopaiyankar@gmail.com	
6)	Mrs. Vinaya Kashikar			
7)	Mrs. A. S. Gadewar			
8)	Mrs. Ashwini Shiledar			
9)	Mrs. A. S. Wanne			

Signature of:

Program In-charge

CO-ORDINATOR
IQAC Coordinator
INTERNAL QUALITY ASSURANCE CELL
DHARAMPETH, M. P. DEO MEMORIAL &
SCIENCE COLLEGE, NAGPUR

Principal
Dharampeth M.P. Deo Memorial
Science College, NAGPUR



DHARAMPETH M. P. DEO MEMORIAL SCIENCE COLLEGE,
North Ambazari Road, Near Ambazari Lake, Nagpur- 440033

DATA VALIDATION & VERIFICATION (DVV)

	Name	mobile	Email	Sign
10	Nandee N. Nikhare	9604944360		
11	Anurag S. Khedkar	9823484662		
12	Kishor S. Daskulkar	9890811470		
13	Dr. A. S. Kale	9423408027		
14	Dr. Nitin Gaikwad	8329172876		
15	Ms. S. O. Rathod	9823129026		
16	Mr. R. K. Thakre	8983561335		
17	Mr. Vedant Badhiye	9422489475		
18	Bisha S. Waghmare	9325377128		
19	Nehar Wadhvani	9322071534		
20	Rohit Mahi	8806262838		
21	Kunal Sonwane	9561057915		
22	Pooja Chopade	7350376689		
23	Dipanshu Shetani	7350376689		
24	P. V. Bawane	9823684662		
25	A. D. Samth	9881073467		

Signature of:

Program In-charge

IQA COORDINATOR
INTERNAL QUALITY ASSURANCE CELL
DHARAMPETH, M. P. DEO MEMORIAL &
SCIENCE COLLEGE, NAGPUR

Principal
Dharampeth M.P. Deo Memorial
Science College, NAGPUR



DHARAMPETH M. P. DEO MEMORIAL SCIENCE COLLEGE,
North Ambazari Road, Near Ambazari Lake, Nagpur- 440033

DATA VALIDATION & VERIFICATION (DVV)

27)	Monali D. Kalamkam	8379824574	MonaliKalamkam46@gmail.com	Monali
28)	Nutan Mankam	7058693708	Nutanmankam1425@gmail.com	Nutan
29)	Saloni C. Landge	9699703706	Salonilandge74@gmail.com	Landge
30)	Rushikesh B. Hambarde	9028225874	rushikeshhb918@gmail.com	Hambarde
31)	Deepak M. Tiwari	9175784046	Deepaktiwari2086@gmail.com	Tiwari
32)	Aditya S. Gosavi	9158948313	adityagosavi71@gmail.com	Gosavi
33)	Lavesh P. Patil	9309902389	laveshpatil1234@gmail.com	Patil
34)	Tanmay P. Tewari	9370144756	tanmaytewar2041@gmail.com	Tewari
35)	Deepak D. Dhakne	8459167742	ddhakne9786@gmail.com	Dhakne
36)	Vivek S. Sah	9923963071	viveksah1893@gmail.com	Sah
37)	Pratyush D. Yadav	9970192409	PratyushD77@gmail.com	Yadav
38)	Payal C. Patil	8766659712	PayalPatil2006@gmail.com	Patil
39)	Shubha Tiwari	9975452559	ShubhaTiwari123@gmail.com	Tiwari
40)	Nitin Rajbhar	9082360041	nitinraj2122@gmail.com	Rajbhar
41)	Satish Malharani	7821097917	Satishmalhar25@gmail.com	Malharani
42)	Sagar Buntohe	7875187455	Sagarbuntohe66@gmail.com	Buntohe

Signature of:

Programme in charge

COORDINATOR
INTERNATIONAL ASSURANCE C.T.I.
DHARAMPETH, M. P. DEO MEMORIAL &
SCIENCE COLLEGE, NAGPUR

Principal
Principal
Dharampeth M.P. Deo Memorial
Science College, NAGPUR



DHARAMPETH M. P. DEO MEMORIAL SCIENCE COLLEGE, NAGPUR
INTERNAL QUALITY ASSURANCE CELL (IQAC)

Activity Report

Date: 30.8.22

Name of Organizing Department or Committee: Home Science In Association with Inner Wheel Club, Nagpur

Name of the activity: Lecture

Suggested CRITERION point if any: 2

Date of Activity: 4.8.22

Place of Activity: APJ Kalam Hall, Dharampeth M P Deo Memorial Science College

Name of Guest Speaker/s or Judge/s or Chief Guest/s if any: Dr. Rajan, Child Paediatrician & Dr Nilofar Muzewar, Paediatrician, as Guest Speaker.

Title of the Activity: Theme- Importance of Breast Feeding

Number of Participants: 10

Name of the Teacher In-charge / Convener: Mrs. Manju Deshpande

Names of other Committee Members / Staff: Entire Faculty of Home Science along with entire Executive members & Staff of Inner Wheel Club, Nagpur.

OUTCOME of the Activity with respect to mission vision of the institute and or academics:

Awareness of the theme given by UNICEF & WHO: Step up for Breast feeding :Educate & Support. Remove misconceptions if any in relation to breast feeding the baby. Students have the topic for Study in the subject Human Development & Nutrition.

Activity with newspaper coverage if any: LiveNagpur

<https://thelivenagpur.com/2022/08/09/importance-of-breastfeeding-dr-nilofar-mujawar/>

Activity data save in PC of: Mrs M M Deshpande.

Note: Kindly share geotag photographs separately along with report on iqacdsc2022@gmail.com



Prof. Pitambar Humane
IQAC Coordinator
CO-ORDINATOR
INTERNAL QUALITY ASSURANCE CELL
DHARAMPETH, M. P. DEO MEMORIAL &
SCIENCE COLLEGE, NAGPUR

Name & Signature of Teacher In-charge

Dr. Akhilesh Peshwe
Principal
PRINCIPAL

Dharampeth M.P. Deo Memorial
Science College, Nagpur-440033



**DHARAMPETH M.P. DEO MEMORIAL SCIENCE
COLLEGE**

HOME SCIENCE DEPARTMENT

IN ASSOCIATED WITH

INNER WHEEL CLUB NAGPUR

Organizing a lecture session on

" IMPORTANCE OF BREASTFEEDING "

To commemorate world breastfeeding week on

4th August

Venue : APJ Kalam hall Dharampeth College Time : 10 am

ALL ARE CORDIALLY INVITED

Mrs. Rucha Deshpande

President

Inner Wheel Club
Nagpur

Mrs. Manju Deshpande

Hod Home Science dept.

Dr. Akhilesh V. Peshwe

Principal

Dharampeth Science
College



INNER WHEEL CLUB

M. Deshpande

DHARAMPETH M P DEO MEMORIAL SCIENCE AND INNER WHEEL CLUB ,NAGPUR JOINTLY CELEBRATES BREAST FEEDING WEEK

Theme :Step up for Breast feeding.Educate & Support

WABA/WORLD BREAST FEEDING WEEK 2022.

World Breast feeding week Celebrated in the Department of Home Science, Dharampeth M P Deo Memorial Science College In Association with the Inner Wheel Club ,Nagpur Divizion. The inauguration of Breast feeding Week was done in the Department of Home Science where in M M Deshpande Madam ,HOD Home Science along with Faculty member Mrs Pradnya Bagalkote Spoke on the theme & Supper Foods important for Lactating Mothers as a part of creating awareness.

4th of August a lecture was arranged on the topic " Importance of Breast Feeding ." Resource Person for the lecture was Dr Nilofar Muzewar a renowned Paediatrician of Nagpur who has been a devoted person since 1985 working similar to the theme of Support & Educate.

At the Outset Seeking blessings of goddess Saraswati,the programme was initiated with a welcome . Mrs M M Deshpande welcomed the Entire team of Inner wheel club members on behalf of Principal,Dr Akhilesh Peshwe & Senior Faculty members of the College.

Dr Rajan,well known Paediatrician and Past President of Inner wheel Introduced the guest Speaker and presented a sapling to her.Dr Rajan Madam was presented a Sapling by Mrs Rucha Deshpande,Present President Inner wheel. A wonderful & very enlightening Lecture was delivered by Dr Nilofar Madam. The lecture went clear with a strong message creating awareness of breast feeding & each one of us should contribute in this huge responsibility

M. Deshpande

to educate & Support . Lecture ended with Question & Answer Session.

Ms Sushmita Mallick student of Home Science conducted the programme proceedings while Vaishnavi Upasak did the technical assistance. Special to mention the programme was attended by Prof Seema Ubale madam, Dr Meghana Pandit, Pradnya Bagalkote, Dr Ashwini Meshram & Students of Home Science.

Mrs Gauri Dhond ,Secretary Inner wheel club ,Nagpur Proposed a formal Vote of thanks. Guests & Dignitaries also enjoyed to visit "Kaushalya Kala Pradarshani-22" a ride to creative Skills of Students of Home Science.

Beshpande

PRINCIPAL

Dharampeth M.P. Deo Memorial
Science College, Nagpur-440033

World Breastfeeding week 1 to 7 August

1st August 2022
class activity



DHARAMPETH M. P. DEO MEMORIAL SCIENCE COLLEGE,
North Ambazari Road, Near Ambazari Lake, Nagpur- 440033

DATA VALIDATION & VERIFICATION (DVV)

Sr.No.	Students name	Mail ID	Phone number	Signature
1	Sushmita Mallick	sushmita760@gmail.com	9837916560	
2	Vaishnavi Upasak	upasekvaishnavi@gmail.com	9925287431	
3	Mahima Wankhed	mahimawankhed@gmail.com	7821883251	
4	Sakshi Thosar	Sakshithosar62@gmail.com	8177911360	
5	Aarohi Ramteke	Aarohiramteke7@gmail.com	8983345716	
6	Vanshika Todape	vanshika.todape@gmail.com	7511744575	
7	Vaishnavi Bahadure	Vaishnavibahadure34@gmail.com	9284679244	
8	Riya Shreebal	shreebal04riya@gmail.com	7249070278	
9	Aarti Raut	araut1234@gmail.com	8625813184	
10	Pooja Chute	laxmichute123@gmail.com	9552381386	

Signature of:

Program In-charge

IQAC Coordinator
CO ORDINATOR
INTERNAL QUALITY ASSURANCE CELL
DHARAMPETH, M. P. DEO MEMORIAL &
SCIENCE COLLEGE, NAGPUR

PRINCIPAL

Dharampeth M. P. Deo Memorial
Science College, Nagpur-440033



DHARAMPETH M. P. DEO MEMORIAL SCIENCE COLLEGE, NAGPUR
INTERNAL QUALITY ASSURANCE CELL (IQAC)

Activity Report

Date: 30.8.22

Name of Organizing Department or Committee: Home Science & Inner wheel Club, Nagpur

Name of the activity: Display of Super Foods for Pregnant and Lactating Women

Suggested CRITERION point if any: II

Date of Activity: 04.8.22

Place of Activity: Department of Home Science

Name of Guest Speaker/s or Judge/s or Chief Guest/s if any: Dr Nilofar

Title of the Activity: Display of Super Food

Number of Participants: 16

Name of the Teacher In-charge / Convener: Pradnya Bagalkote

Names of other Committee Members / Staff: Entire Department of Home Science

OUTCOME of the Activity with respect to mission vision of the institute and or academics:
Awareness of the theme given by UNICEF & WHO: Step up for Breast feeding : Educate & Support. Concept of nutritional rich food named as super Food for Lactating Mothers.
Display with labels stuck were done to be able to identify the food item with significance in the diet of Mother who feed to her Baby.

Activity with newspaper coverage if any:

Activity data save in PC of : Mrs Manju Deshpande

Note: Kindly share geotag photographs separately along with report on iqacdsc2022@gmail.com



Prof. Pitambar Humane
COORDINATOR
INTERNAL QUALITY ASSURANCE CELL
DHARAMPETH, M. P. DEO MEMORIAL &
SCIENCE COLLEGE, NAGPUR

Pradnya Bagalkote
Manju Deshpande

Name & Signature of Teacher In-charge

Dr. Akhilesh Peshwe
Principal
PRINCIPAL
Dharampeth M. P. Deo Memorial
Science College, Nagpur-440033



**DHARAMPETH MP DEO MEMORIAL
SCIENCE COLLEGE, NAGPUR**

Department Of Home Science



WABA | WORLD BREASTFEEDING WEEK 2022

**WORLD
BREASTFEEDING
WEEK**

(1st-7th August)



**DHARAMPETH M P DEO MEMORIAL SCIENCE AND INNER WHEEL CLUB ,
NAGPUR JOINTLY CELEBRATES BREAST FEEDING WEEK**

Theme :Step up for Breast feeding.Educate& Support

WABA/WORLD BREAST FEEDING WEEK 2022.

World Breast feeding week Celebrated in the Department of Home Science, Dharampeth M P Deo Memorial Science College In Association with the Inner Wheel Club ,NagpurDivizion. The inauguration of Breast feeding Week was done in the Department of Home Science where in M M Deshpande Madam ,HOD Home Science along with Faculty member Mrs PradnyaBagalkote Spoke on the theme & Supper Foods important for Lactating Mothers as a part of creating awareness.

4th of August a lecture was arranged on the topic " Importance of Breast Feeding ." Resource Person for the lecture was Dr NilofarMuzewararenowned Paediatrician of Nagpur who has been a devoted person since 1985 working similar to the theme of Support & Educate.

At the Outset Seeking blessings of goddess Saraswati,the programme was initiated with a welcome . Mrs M MDeshpande welcomed the Entire team of Inner wheel club members on behalf of Principal,DrAkhileshPeshwe& Senior Faculty members of the College.

Dr Rajan,well known Paediatrician and Past President of Inner wheel Introduced the guest Speaker and presented a sapling to her.DrRajan Madam was presented a Sapling by Mrs RuchaDeshpande,Present President Inner wheel. A wonderful & very enlightening Lecture was delivered by Dr Nilofar Madam. The lecture went clear with a strong message creating awareness of breast feeding & each one of us should contribute in this huge responsibility to educate &Support . Lecture ended with Question & Answer Session.

Ms SushmitaMallick student of Home Science conducted the programme proceedings while VaishnaviUpasak did the technical assistance. Special to mention the programme was attended by Prof SeemaUbalemadam, Dr Meghana Pandit, Pradnya Bagalkote, Dr Ashwini Meshram & Students of Home Science.

Mrs GauriDhond ,Secretary Inner wheel club ,Nagpur Proposed a formal Vote of thanks. Guests & Dignitaries also enjoyed to visit "Kaushalya Kala Pradarshani-22" a ride to creative Skills of Students ofHomeScience.

N. Deshpande

World Breastfeeding week 1 to 7 August

1st August 2022.
class activity



DHARAMPETH M. P. DEO MEMORIAL SCIENCE COLLEGE,
North Ambazari Road, Near Ambazari Lake, Nagpur- 440033

DATA VALIDATION & VERIFICATION (DVV)

Sr. No.	Students name	Mail ID	Phone number	Signature
1.	Sushmita Mallick	sushmita2002@gmail.com	982916530	Sushmita
2.	Vaishnavi Upasak	upasakvaishnavi@gmail.com	9925287431	Vaishnavi
3.	Mahima Wankhed	mahimawankhed12@gmail.com	7821883251	Mahima
4.	Sakshi Thosar	SakshiThosar52a@gmail.com	8177911340	Sakshi
5.	Arushi Randekar	ArushiRandekar7@gmail.com	9983345716	Arushi
6.	Vanshika Todase	vanshikatodase@gmail.com	9511744535	Vanshika
7.	Vaishnavi Bahadure	Vaishnavibahadure2002@gmail.com	9284679244	Vaishnavi
8.	Riya Shekhar	shekhar.riya@gmail.com	7249070278	Riya
9.	Aarti Raut	Aarti234@gmail.com	8625813184	Aarti
10.	Pooja Chute	laxmichute123@gmail.com	9552381386	Pooja

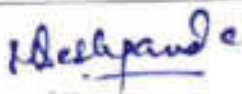
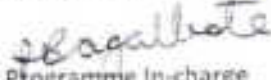
Signature of: 

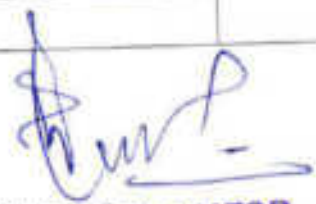
Programme In-charge

IQAC COORDINATOR
INTERNAL QUALITY ASSURANCE CELL
DHARAMPETH, M. P. DEO MEMORIAL &
SCIENCE COLLEGE, NAGPUR

PRINCIPAL
Dharampeth M. P. Deo Memorial
Science College, Nagpur-440032

DHARAMPETH M P DEO MEMORIAL SCIENCE COLLEGE

DEPARTMENT OF HOME SCIENCE

NOTICE

A lecture on Importance of Breast feeding is arranged .

Venue : APJ Hall

Time : 10 am

This programme is in Association with Inner club Nagpur.

Guest Speaker is Dr. Nilofar Mujawar

Dr Rajan , leading Paediatrician of Nagpur will be to grace the occasion

All my faculty must be there

Reach at least 15 minutes before the programme .

Meeshpande

HOD Home Science .



DHARAMPETH M. P. DEO MEMORIAL SCIENCE COLLEGE, NAGPUR
INTERNAL QUALITY ASSURANCE CELL (IQAC)

Activity Report

Date: 28th Oct., 2022

Name of Organizing Department or Committee: NATIONAL SERVICE SCHEME (NSS)

Name of the activity: Blood Donation

Suggested CRITERION point if any: CRITERION-III

Date of Activity: 8th August, 2022

Place of Activity: Dr. A. P. J. Abdul Kalam Hall

Name of Guest Speaker/s or Judge/s or Chief Guest/s if any: Shri. Mangesh Phatak

Title of the Activity: Blood Donation Camp

Number of Participants: 55

Name of the Teacher In-charge / Convener: Prof. Pitambar Humane

Names of other Committee Members / Staff: Dr. Nitin Gaikwad, Prof. Mrs. Varsha Rangari, Dr. Mrs. Shraddha Deshpande, Dr. Mrs. Kirti Paturkar, Mrs. Ruma Kapre

OUTCOME of the Activity with respect to mission vision of the institute and or academics:

This activity is organized every year in Memory of Late Shri Vinayakrao Phatak. Ex-Principal in association with Hedgewar Blood Bank. During this camp 25 Units of blood was collected. Many students were checked their BP and Haemoglobine in the Camp. The Camp makes the students aware about the blood donation and its importance. This type of activity introduces social responsibility among the students as well as help to get rid from fear of blood donation.

Activity with newspaper coverage if any:

Activity data save in PC of: Prof. Pitambar Humane's Laptop



Prof. Pitambar Humane
IQAC Coordinator

CO ORDINATOR
INTERNAL QUALITY ASSURANCE CELL
DHARAMPETH, M. P. DEO MEMORIAL &
SCIENCE COLLEGE, NAGPUR

Name & Signature of Teacher In-charge

Dr. Akhilesh Peshwe
Principal
Dharampeth M.P. Deo Memorial
Science College, Nagpur.



DHARAMPETH M. P. DEO MEMORIAL SCIENCE COLLEGE, NAGPUR

NATIONAL SERVICE SCHEME (NSS)

Blood Donation Programme

8th Aug., 2022

Sr. No.	Name of the Student	email id	Mobile Number
1	ravindra Madhukar khadse	khadseravindra892@gmail.com	8007198273
2	Rishika Rajesh kokate	kokaterishika@gmail.com	9637554918
3	MANTHAN MUKESH TODASE	manthantodase@gmail.com	7020463916
4	PRERNA JAGADISH CHAUDHARI	jagdishchoudhar07@gmail.com	7620384149
5	NISHA SHRIRAM KOSARKAR	nishakosarkar333@gmail.com	9890996645
6	ANSHIKHA URKUDA JARWARKAR	anshikhajarwarkar@gmail.com	9021391207
7	PRANALI RATNAKAR JI DEHNAKAR	pdehna@gmail.com	8767581278
8	ANJALI RAJENDRA THAKRE	thakreanju381@gmail.com	7066554821
9	ANJALI RAJENDRA THAKRE	thakreanju381@gmail.com	7066554821
10	NIHAL VISHAL MESHRAM	nihalmeshram74@gmail.com	8767792960
11	VAISHNAVI NAMDEV TONGE	vaishutonge2004@gmail.com	8421657943
12	SUNAINA PREM CHICHONDE	sunainachichonde123@gmail.com	8530970132
13	ANSHIKHA URKUDA JARWARKAR	anshikhajarwarkar@gmail.com	9021391207
14	VAISHNAVI DINESH BAHADURE	vaishnavibahadure34@gmail.com	9284679244
15	SHARWARI LALCHAND UMARE	sharvariumare1912@gmail.com	9284249534
16	MUSKAN VINAY KULKARNI	muskankulkarni34@email.com	9165889293
17	SHRUTI SURENDRA CHANNEKAR	shrutichannekar706@gmail.com	9699823842
18	GUNJAN ISHWAR BHOYAR	gunjanbhoyar04@gmail.com	7666799586
19	Gauri Ramesh bhoyar	gunjanbhoyar34@gmail.com	8668335876
20	Rishika rajesh kokate	kokaterishika@gmail.com	9637554918
21	SAKSHI RAJU CHAKUNDE	sakshichakunde@gmail.com	7843018801
22	Shrushtee jaysingh Rathod	jaysinghr673@gmail.com	7776026256
23	SEJAL DNYANESHWAR KOLHE	kolhesejal04@gmail.com	8483045985
24	KIRAN KISNA GHUGHUSKAR	kolheseju96@gmail.com	9823710569
25	PRATIKSHA MANGAL MESHRAM	meshrampratiksha14@gmail.com	8459070338
26	MUSKAN RAMESHWAR YADAV	muskanyadav1225@gmail.com	9579492617
27	UDAY CHANDRASHEKHAR BAGHELE	bagheleuday@gmail.com	8459549609
28	DURGESH KISHOR GHODMARE	durgeshghodmare0011@gmail.com	9075318618
29	SAKSHI VITTHAL CHAMATE	chamatesakshi24@gamil.com	7709204933
30	VANSHIKA CHHOTELA YEDE	vanshikayede1@gmail.com	7558244609
31	RUSHIKESH BHAURAO HAMBARDE	rushikeshhambarde9786@gmail.com	9028225874
32	AAKANSHA KAMAL KHOBRAGADE	aakanshakhobragade7@gmail.com	7972228707
33	SALONI DYANESHWAR DONGRE	dongresaloni0@gmail.com	99233 61488
34	MUKESH JAWARA ORAON	oraonm64@gmail.com	7249339368

Sr. No.	Name of the Student	email id	Mobile Number
35	NEHA ARVIND WAGHADE	nehawaghade16082002@gmail.com	7249895144
36	PRACHAL MANIK MESHRAM	prachalmeshram47@gmail.com	7028735508
37	VEENA ULHAS BORIKAR	veenaborikar14@gmail.com	9322016921
38	SAURABH PRATAP SHARMA	saurabhsharma1069@gmail.com	9130964601
39	VARSHA LEKHRAM TURKAR	varshaturkar488@gmail.com	9373650950
40	RUTIKA GORAKH YADAV	yadavrutika434@gmail.com	8446085943
41	SANIYA PRAVEEN NAIK	saniyanaik51@gmail.com	9370570457
42	OM SURESH DHURVE	omdhurve277@gmail.com	8767016318
43	SRUSHTI MADAN GAIKWAD	srushtigaikwad86935@gmail.com	7385532705
44	VAISHNAVI RAMKRUSHNA CHANDEKAR	vaishnavichandekar000@gmail.com	7249882964
45	RAKHI PRABHAKAR GEDAM	gedamrakhi2000@gmail.com	7378312504
46	RANI BHIWAJI KATWALE	bkrani8112@gmail.com	9011247038
47	SAKSHI PRAVIN MANKAR	sakshi2018mmm@gmail.com	8180816539
48	PRANALI RATNAKAR DEHANKAR	pdehna@gmail.com	8767581278
49	NEHA JAGDISH BANKAR	neha2002bankar@gmail.com	8055477553
50	PRANAY SUNIL DHORE	dhorepranay532@gmail.com	8830629245
51	SIMRAN NARENDRA DHIMOLE	mishralaxmi210@gmail.com	9284583851
52	ANJALI RAJENDRA THAKRE	thakreanju381@gmail.com	7066554821
53	AMAN SUJIT KARN	karn7817@gmail.com	9028837552
54	VAIBHAV ARUN MALEWAR	vaibhavmalewar94@gmail.com	8767838219
55	MAHIMA SUNIL KHARE	mahimakhare11@gmail.com	9545918678



Prof. Pitambar Humane

Program Officer, NSS



DHARAMPETH M.P. DEO MEMORIAL SCIENCE COLLEGE, NAGPUR
ROTARACT CLUB OF DMPDSVM
Activity Report

Date: 30/08/2022

Name of Organizing Department or Committee: Rotaract Club

Name of the activity: Rakshabandhan

Suggested CRITERION point if any: Criterion III & Criterion V

Date of Activity: 11 August 2022

Place of Activity: College

Name of Guest Speaker/s or Judge/s or Chief Guest/s if any: Title of the Activity: Rakshabandhan

Number of Participants: 43

Name of the Teacher In-charge/Convener: Dr. Mrs. Shraddha Deshpande

Names of other Committee Members/Staff: Rotaract Club Members

OUTCOME of the Activity with respect to mission vision of the institute and or academics:

Rakshabandhan is the safety of bond that a sister ties to a brother. The Rotaractors send Rakhis to their brothers on borders as a way to shower their love, respect and thanks for the brave task they are doing for us.

Activity with newspaper coverage if any: Nil

Activity data save in PC of: Department of English



Prof. Pitambar Humane
IOAC Coordinator
CO ORDINATOR
INTERNAL QUALITY ASSURANCE CELL
DHARAMPETH, M. P. DEO MEMORIAL &
SCIENCE COLLEGE, NAGPUR

Dr. Mrs. Shraddha Deshpande
Teacher In-charge

Dr. Akhilesh Peshwe
Principal
Dharampeth M.P. Deo Memorial
Science College, Nagpur.



DHARAMPETH M.P.DEO MEMORIAL SCIENCE COLLEGE, NAGPUR

ROTARACT CLUB 22-23

Rakhi for Rakshak 2.0

11th August 2022

Rotary.org Link:





DHARAMPETH M. P. DEO MEMORIAL SCIENCE COLLEGE,
North Ambazari Road, Near Ambazari Lake, Nagpur- 440033

DATA VALIDATION & VERIFICATION (DVV)

Name of the Programme : Raksha Bandhan (Rakhi Jore Rakshak 2.0)
Date of the Programme : 11/08/22
Name of Chief Guest if any : -
Name of ^{Co-ordinator} Guest Speaker if any : Aditi Lute, Dhammaparviti Lale, Harsh Kodape

Sr. No.	Name of the Participant	Mobile Number	E-mail Id	Signature
1.	Tejas Solanke	7030730670	tejasolanke208@gmail.com	
2.	Georgi Hodge	4942076671	georgihodge@gmail.com	<u>Georgi</u>
3.	Ananya Motghare	7219218955	ananya motghare 1802@gmail.com	
4.	Nupur Sharma	9322042259	nupursharma258@gmail.com	<u>Nupur</u>
5.	Harsh Kodape	9604677672	harshkodape008@gmail.com	<u>Harsh</u>
6.	Mehar Raza	8875726700	meharazania@gmail.com	<u>Mehar</u>
7.	Dhammaparviti Lale	9975037356	dhammaparviti191@gmail.com	<u>Dhammaparviti</u>
8.	Aditi Lute	7860812303	aditilute191@gmail.com	
9.	Potajwal Bhoyar	8010434634	potajwalb138@gmail.com	
10.	Rohit Pawate	9373097285	pawaterohit8@gmail.com	

Signature of:

SAD Solanke
Programme In-charge

M. P. Deo
CO ORDINATOR
IQAC Coordinator
INTERNAL QUALITY ASSURANCE CELL
DHARAMPETH, M. P. DEO MEMORIAL &
SCIENCE COLLEGE, NAGPUR

M. P. Deo
Principal
Dharampeth M.P. Deo Memorial
Science College, Nagpur



DHARAMPETH M. P. DEO MEMORIAL SCIENCE COLLEGE,
North Ambazari Road, Near Ambazari Lake, Nagpur- 440033

DATA VALIDATION & VERIFICATION (DVV)

11.	Sanchita Patil	9218079094	sanchitapatil2003@gmail.com	
12.	Vedant Baxy	8530455796	vedantbaxy2003@gmail.com	Baxy
13.	Renuka Lande	7719951401	renukalande22@gmail.com	
14.	Kavita Mishra	9657199261	km7832889@gmail.com	Mishra
15.	Apurva Verulkar	9623613911	apurva.verulkar@gmail.com	Apurva
16.	Riya Maity	7350980367	maityriya23@gmail.com	Riya
17.	Sakshi Karode	8806934839	sakshikarode326@gmail.com	Karode
18.	Durgesh Rokde	9730561301	rokdedurgesh1@gmail.com	Durgesh
19.	Kunal Digriase	8010274303	kunaldigriase777@gmail.com	Kunal
20.	Jay Patil	7385436956	jay.patil0326@gmail.com	Patil
21.	Ashmit Juwar	8080238161	ashmitjuwar@gmail.com	Ashmit
22.	Simran Talmale	79925303358	simrantalmale@gmail.com	Simran Talmale
23.	Ankita Mishra	9192698537	ankita58965@gmail.com	Ankita
24.	Ashish Singh	7276005219	ashishsingh35602@gmail.com	ASingh
25.	Anuj Mishra	8103656208	anujmishra251202@gmail.com	AM
26.	Harsh Singh Rajat	8830408958	harshsinghpetlover420@gmail.com	Harsh

Signature of:

Programme In-charge

COORDINATOR
INTERNAL QUALITY ASSISTANCE CELL
DHARAMPETH, M. P. DEO MEMORIAL &
SCIENCE COLLEGE

Principal
Dharampeth M.P. Deo Memorial
Science College



DHARAMPETH M. P. DEO MEMORIAL SCIENCE COLLEGE,
North Ambazari Road, Near Ambazari Lake, Nagpur- 440033

DATA VALIDATION & VERIFICATION (DVV)

27.	Potabhar Buraadkar	8329760853	potabhar.buraadkar56@gmail.com	<u>Potabhar</u>
28.	Aditya Shukla	9518994638	aditya.shukla0025@gmail.com	<u>Aditya</u>
29.	Aditya Mishra	7218484186	adityamishra3933@gmail.com	<u>Aditya</u>
30.	Ruchika Patle	8669335907	suchikapatle4@gmail.com	<u>Ruchika</u>
31.	Nutan Surjuse	8805570279	nutansurjuse2@gmail.com	<u>Nutan</u>
32.	Prajakta Pawar	9356905759	prajakta2404@gmail.com	<u>P.P.</u>
33.	Bhumika Thakre	7218247917	bhumikathakre55@gmail.com	<u>Bhumika</u>
34.	Sakshi Ingle	9067877694	Inglesakshi703@gmail.com	<u>Singh</u>
35.	Ishita Deshpande	9130091540	ishitadeshpande2100@gmail.com	<u>Ishita</u>
36.	Sharvaxi Umare	9284249524	sharvaxiumare1912@gmail.com	<u>Sharvaxi</u>
37.	Avishkar A Bansod	7870841788	avishkarbansod02@gmail.com	<u>A. A. Bansod</u>
38.	Vaishnavi V. Gadge	9022976449	gadgavaishnavi00@gmail.com	<u>V. Gadge</u>
39.	SAHIL SINGH	7258868802	sahilbsingh06@gmail.com	<u>Sahil</u>
40.	Harshad warthi	7414993575	harshadwarthi9592@gmail.com	<u>Harshad</u>
41.	Ashlesha Sangole	9503998469	Ashleshasangole94@gmail.com	<u>Ashlesha Sangole</u>
42.	Nikita Bavapatkar	7058625053	puachibavapatkar@gmail.com	<u>Nikita</u>

Signature of:

Ishita Deshpande
Programme In-charge

Ishita Deshpande
CO ORDINATOR
INTERNAL QUALITY ASSURANCE CELL
DHARAMPETH, M. P. DEO MEMORIAL &
SCIENCE COLLEGE, NAGPUR

Ishita Deshpande
Principal
Dharampeth M. P. Deo Memorial
Science College, Nagpur.



DHARAMPETH M. P. DEO MEMORIAL SCIENCE COLLEGE,
 North Ambazari Road, Near Ambazari Lake, Nagpur- 440033

DATA VALIDATION & VERIFICATION (DVV)

43.	Simran Dhimale	7666330683	simrاندhimale80@gmail.com	Dhimale
44.				
45.				
46.				
47.				
48.				
49.				
50.				

CO ORDINATOR
 INTERNAL QUALITY ASSURANCE CELL
 DHARAMPETH, M. P. DEO MEMORIAL &
 SCIENCE COLLEGE, NAGPUR

Principal
 Dharampeth M. P. Deo Memorial
 Science College, Nagpur.

Signature of:

 Programme In-charge



**DHARAMPETH M. P. DEO MEMORIAL SCIENCE COLLEGE, NAGPUR
ROTARACT CLUB OF DMPDSVM**

Activity Report

Date: 30 /11/2022

Name of Organizing Department or Committee: ROTARACT CLUB OF DMPDSVM

Name of the activity: Azadi Ka Amtrit Mahotsav

Suggested CRITERION point if any: Criterion III & Criterion V

Date of Activity: 13 August 2022

Place of Activity: College

Name of Guest Speaker/s or Judge/s or Chief Guest/s if any: NIL

Title of the Activity: Azadi Ka Amtrit Mahotsav ; Competition

Number of Participants: 13

Name of the Teacher In-charge / Convener: Dr.Mrs.Shraddha Deshpande

Names of other Committee Members / Staff: Rotaract Club Members

OUTCOME of the Activity with respect to mission vision of the institute and or academics:

A reel, salad and ideal leader paragraph competition was very much demanded by the students. There are indeed grooming reels makers who needed a motivation to start up with their skill. It can not only become a hobby but also can be a rigid career for someone. To conduct competitions like these improve organizational skills and Work projects are typically centered on a rigid timeline, and organizing smaller projects and goals can be an effective way to complete them.

Activity with newspaper coverage if any: NIL

Activity data save in PC of: Department of English

Prof. Pitambar Humane
IQAC Coordinator

CO ORDINATOR
INTERNAL QUALITY ASSURANCE CELL
DHARAMPETH, M. P. DEO MEMORIAL &
SCIENCE COLLEGE, NAGPUR

Dr. Mrs. Shraddha Deshpande
Teacher In-charge

Dr. Akhilesh Peshwe
Principal
Principal
Dharampeth M.P. Deo Memorial
Science College, Nagpur.



DHARAMPETH M.P.DEO MEMORIAL SCIENCE COLLEGE, NAGPUR

ROTARACT CLUB 22-23

Azadi ka Amrit Mohotsav

13th August 2022

Rotary.org Link





DHARAMPETH M.P.DEO MEMORIAL SCIENCE COLLEGE, NAGPUR

ROTARACT CLUB 22-23

Azadi ka Amrit Mohotsav

13th August 2022

List of Students

Sr.	Name	Contact Number
1	Harsh kodape	9604677672
2	Ananya Motghare	7219218955
3	Gargi Hadge	7972076671
4	Nupur Sharma	9322042259
5	Prajwal Bhoyar	8010434634
6	Sania Midhat Raza	8975726700
7	Vaishnavi Gadge	9022976449
8	Vedant Baxy	8530455796
9	Aditi Lute	7820812303
10	Renuka Lande	7719951401
11	Sanchita Patil	7218079074
12	Dhammapriti lale	9975037356
13	Avishkar Bansod	7820841788



DHARAMPETH M. P. DEO MEMORIAL SCIENCE COLLEGE, NAGPUR
INTERNAL QUALITY ASSURANCE CELL (IQAC)

Activity Report

Date: 28th Oct., 2022

Name of Organizing Department or Committee: NATIONAL SERVICE SCHEME (NSS)

Name of the activity: Rally

Suggested CRITERION point if any: CRITERION-III

Date of Activity: 14th August, 2022

Place of Activity: Ambazari and Yashwant Nagar premises

Name of Guest Speaker/s or Judge/s or Chief Guest/s if any: Dr Shashikala Vanjari

Title of the Activity: Rally on *Har Ghar Tiranga, Ghar Ghar Tiranga*

Number of Participants: 85

Name of the Teacher In-charge / Convener: Prof. Pitambar Humane

Names of other Committee Members / Staff: Dr. Nitin Gaikwad, Prof. Mrs. Varsha Rangari, Dr. Mrs. Shraddha Deshpande, Dr. Mrs. Kirti Paturkar, Mrs. Ruma Kapre

OUTCOME of the Activity with respect to mission vision of the institute and or academics:

To celebrate 75th Independence Day in 2022, the rally was organized to spread the awareness about flag hoisting in every day in the country. There was tremendous support from staff and students in this rally. Many local peoples were also curious to see the rally on this cause of *Har Ghar Tiranga, Ghar Ghar Tiranga*. After the rally snacks were distributed to the students and staff involved in the rally.

Activity with newspaper coverage if any:

Activity data save in PC of: Prof. Pitambar Humane's Laptop



Prof. Pitambar Humane
IQAC Coordinator

CO ORDINATOR
INTERNAL QUALITY ASSURANCE CELL
DHARAMPETH, M. P. DEO MEMORIAL &
SCIENCE COLLEGE, NAGPUR

Name & Signature of Teacher In-charge

Dr. Akhilesh Peshwe
PH101011
Dharampeth M.P. Deo Memorial
Science College, Nagpur.



DHARAMPETH M. P. DEO MEMORIAL SCIENCE COLLEGE, NAGPUR

NATIONAL SERVICE SCHEME (NSS)

**Rally on Har Tiranga, Ghar Ghar Tiranga
14th Aug., 2022**

Sr. No.	Name of the Student	email id	Mobile Number
1	NIKHIL KIRAN IJANKAR	nikhilijankar@gmail.com	8530960407
2	TUSHAL RUPKUMAR ACHARE	acharetushal5@gmail.com	9075995617
3	ABHISHEK DIWAKAR DESHBHRATAR	abhishekdeshbhratar86@gmail.com	8208302902
4	MAHIMA SUNIL KHARE	mahimakhare11@gmail.com	9545918678
5	Nikita Shriram Bhawe	nikitabhawe98@gmail.com	9860159628
6	Vivek Kushwaha	kushwaha2389@gmail.com	9373163514
7	PRATIK RAMCHANDRA SHETE	pratikshete193@gmail.com	9356716253
8	PRATISH DILIP GOLAIT	pratishgolait99@gmail.com	9579343851
9	KHUSHI DINESH WAGHADE	khushiwaghade1@gmail.com	9156520783
10	RAJESH YASHWANT MESHRAM	rajeshmeshram752@gmail.com	9561216491
11	AAKANSHA YOGESH MAIRAL	aaakuyogi2004@gmail.com	8010923662
12	Mohit Khirdekar	mohitkhirdekar@gmail.com	8055328357
13	SHITAL GOPICHAND BANKAR	shitalbankar122@gmail.com	7758055139
14	VAISHNAVI TARACHAND KAPSE	vaishnavikapse05@gmail.com	8983751089
15	JANVI VASUDEVRAO KHODE	janvikhode882@gmail.com	7385066634
16	NITIN LUARANLAL HARINKHEDE	harinkhedevijay0@gmail.com	9561179324
17	TEJAS RAJESH CHELMELWAR	tejaschelmelwar@gmail.com	9604662119
18	RISHIKESH RAJENDRA DETHE	rishikeshdethe2002@gmail.com	8788199260
19	DIVYANI UMAKANT DHULE	divyanidhule2002@gmail.com	7030731921
20	VISHAL VITTHALRAO GIRHALE	vishalgirhale27@gmail.com	9673681472
21	DIVYANI VITTHAL ZAGADE	divyanizagade@gmail.com	9022866318
22	PRANALI VIPIN GUPTA	rg991537@gmail.com	7020069377
23	ABHISHEK ANIL FALKE	abhishekphalke888@gmail.com	7823835535
24	RITIKA RAVINDRA BHOYAR	ritikabhoyar28@gmail.com	9834587087
25	HIMANSHU RAJU LAKHE	himanshurlakhe08@gmail.com	7448252469
26	SAKSHI AVINASH LONARE	sakshilonare837@gmail.com	7387483720
27	SRIYANSH SANJIB SHEEL	sriyanshsheelthegreat@gmail.com	9322148375
28	VIDYA EKNATH LOHI	vidyalohi8@gamil.com	7020963219
29	Pawan shivkumar Vishwakarma	pawanvishwakarma67448@gmail.com	7058408869
30	SIMRAN GAJANAN TALMALE	simrantalmale@gmail.com	7972530338
31	PRANALI RATNAKAR DEHANKAR	pdehna@gmail.com	8767581278
32	PRACHI SURESH MANUSMARE	PRACHIMANUSMARE1@GMAIL.COM	9356969609
33	REEYA RAHUL MUNDALE	reeyamundale@gmail.com	9.1936E+11
34	SAMIR PRAKASH GHUMDE	sameerghum2002@gmail.com	9359236713

Sr. No.	Name of the Student	email id	Mobile Number
35	ANJALI RAJENDRA THAKRE	thakreanju381@gmail.com	7066554821
36	SUHANI PRASHANT KOHARE	suhanikohre@gmail.com	7776895303
37	SATAL RAJESH JAISWAL	safaljaiswal487@gmail.com	7219533166
38	TUSHAL RUPKUMAR ACHARE	acharetushal5@gmail.com	9075995617
39	NEHA LALCHAND WANJARI	nehawanjari733@gmail.com	9373832266
40	MEGHA SANJAY FULWAR	meghafulwar@gmail.com	8605399606
41	RASHI RAVINDRA SATPUTE	rashisatpute77@gmail.com	9145486983
42	DHAMMAPRITI RAJENDRA LALE	dhammapritiraj@gmail.com	9975037356
43	BHARGAVI ABHIJEET SAMBARE	bhargavisambare05@gmail.com	7709403806
44	NANDINI SURESH HADGE	nandinihadge17@gmail.com	9370301679
45	SAKSHI SURESH CHAUDHARY	sakshichaudhary777333@gmail.com	8766852462
46	AKASH DEBABRATA DAS	akashddas@hotmail.com	7972942799
47	TANMAY SUNIL GADAM	tanmaygadam1@gmail.com	7262034396
48	MONIKA INDRABHAN PATEL	monikapatel7038@gmail.com	7499225468
49	SHITAL OMKAR PATLE	sp985569@gmail.com	9764596337
50	MEGHA SHANKAR BALLAV	meghaballav04@gmail.com	9421728880
51	SHIKHA JAWAHARLAL YADAV	shikha.yadav.sy2002@gmail.com	7263881320
52	VAISHALI SANJAY PATLE	vaishalipatle179@gmail.com	9322600647
53	ADITI SUBHASH JOGI	aditi.jogi2002@gmail.com	9579962108
54	ADITI SUBHASH JOGI	aditi.jogi2002@gmail.com	9579962108
55	SUSHMA GANGADHAR GURNULE	Sushmagurnule12@gmail.com	9156238747
56	SUBBU RAJNIKANT MISHRA	subbumishra234@gaiml.com	9860436418
57	ANVAY BHOJRJ BORKER	anvayborker420@gmail.com	9145401246
58	ANVAY BHOJRAJ BORKER	anvayborker420@gmail.com	9145401246
59	SAKSHI AJAY MISHRA	SMISHRA39683@GMAIL.COM	91587 88969
60	BHAVESH RAMESHWAR MASKE	bhaveshmaske2002@gmail.com	7489951631
61	ANUSHRI SHRIKANT WELE	anushriwele2001@gmail.com	8530778433
62	Prathmesh sanju Badhiye	prathmeshbadhiye19@gmail.com	9765262138
63	VANSHITA DEORAO VAIDYA	vanshitavaidya@gmail.com	7558619065
64	Rani Dadanprasad Patel	ranipate5515@gmail.com	7888241794
65	PRATIBHA BABARAO BHUSARI	babaraoibhusari521@gmail.com	7821048413
66	SHRUTIKA GAJANAN PISE	shrutikapise67@gmail.com	9322316336
67	KUNAL SANJAY DIGRASE	kunaldigrase777@gmail.com	8010274303
68	NITIN LURANLAL HARINKHEDE	harinkhedevijay0@gmail.com	9561179324
69	AVISHKAR ANIL BANSOD	avishkarbansod02@gmail.com	7820841788
70	Akshay premdas khandare	akshaykhandare79@gmail.com	7350956809
71	RENUKA VISHAL LANDE	renukalande220@gmail.com	9.1772E+11
72	ADITYAKUMAR SHYAMALKUMAR SHUKLA	adityashukla0025@gmail.com	9518994638
73	ADITI ALESHWAR LUTE	aditilute161@gmail.com	7820812303

Sr. No.	Name of the Student	email id	Mobile Number
74	Chetan umashankar Bopche	chetanbopche27@gmail.com	9172484628
75	HITESH GANESH KAWARE	hiteshkaware73@gmail.com	7058427112
76	ANANYA RAVINDRA MOTGHARE	ananyamotghare1802@gmail.com	7219218955
77	OMKUMAR DEVLAL DEVANGAN	ommamaji12@gmail.com	9763624388
78	AAKANSHA KAMAL KHOBRAGADE	aakanshakhobragade7@gmail.com	7972228707
79	MAHESH DHARMARAJ PAWDE	pawdemahesh97@gmail.com	7499393930
80	JANVI ASHOK KOSARKAR	janvikosarkar@gmail.com	7888116270
81	TINA GAJANAN RAHANGDALE	tinarahangadale@gmail.com	9921776769
82	SANCHITA SUNIL PATIL	sanchitapatil2003@gmail.com	7218079074
83	SHWETA RANGRAO BEDWAL	shwetabedwal2605@gmail.com	8080440184
84	BHAGYASHREE SANJAY THAKARE	thakrebhagyashree2003@gmail.com	8766925275
85	DINESH INDRAJEET PARTETI	partetidinesh51@gmail.com	7378926076



Prof. Pitambar Humane

Program Officer, NSS



DHARAMPETH M. P. DEO MEMORIAL SCIENCE COLLEGE, NAGPUR
INTERNAL QUALITY ASSURANCE CELL (IQAC)

Activity Report

Date: 18/8/2022

Name of Organizing Department or Committee: 13th August , 2022 celebration committee

Name of the activity: Azadi ka Amrit Mohotsav

Suggested CRITERION point if any: Criteria I

Date of Activity: 13/08/2022

Place of Activity: Dharampeth M. P. Deo Memorial Science College Nagpur

Name of Guest Speaker/s or Judge/s or Chief Guest/s if any: Dr. Akhilesh Peshwe

Title of the Activity: (National Celebration)

Number of Participants: All staff members and students

Name of the Teacher In-charge / Convener: - Dr. Vaishali Meshram

Names of other Committee Members / Staff: Dr. Kalode, Dr. Lt. Ambekar , Mr. Atul Moghe

OUTCOME of the Activity with respect to mission vision of the institute and or academics:

This year Independence Day is celebrated as Azadi ka Amrit Mahotsav from 13th August to 15th August. On the eve of Azadi ka amrit Mahotsav of India, college celebrated the occasion with NCC students and college staff .

Activity with newspaper coverage if any: ----No

Activity data save in PC of: Chemistry



Prof. Pitambar Humane
IQAC Coordinator
CO ORDINATOR
INTERNAL QUALITY ASSURANCE CELL
DHARAMPETH, M. P. DEO MEMORIAL &
SCIENCE COLLEGE, NAGPUR

Name & Signature of Teacher In-charge

Dr. Akhilesh Peshwe
Principal
Principal
Dharampeth M.P. Deo Memorial
Science College, Nagpur.



Teaching Staff 2022-2023

13/08/2022

(Sr.College)

Sr. No.	Name of Employee	Designation/Department	Signature
1.	Dr. Akhilesh V. Peshwe	Principal	
2.	Dr. Mrs. Varsha Vinod Rangari	(Associate Professor) Electronics	
3.	Dr. Pitambar. Tulshiram Humane	(Associate Professor) Botany	
4.	Dr. (Mrs.) Vidya. Ratan Katoke	(Associate Professor) Microbiology	
5.	Dr. (Mrs.) Kirti. Mangesh Paturkar	(Assistant Professor) Zoology	
6.	Dr. (Mrs.) Seema. Kiran Ubale	(Associate Professor) Physics	
7.	Lt. Dr. Prashant. Wamanrao Ambekar	(Associate Professor) Physics	
8.	Dr. (Mrs.) Vaishali. Pravin Meshram	(Associate Professor) Chemistry	
9.	Dr. Nitin Pravin Gaikwad	(Assistant Professor) Mathematics	
10.	Mrs. Manju Milind. Deshpande	(Associate Professor) Home Science	
11.	Dr. Mrs. Shradha. Abhijit Deshpande	(Assistant Professor) English	

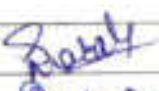
Computer Science

Sr. No.	Name of Employee	Designation/Department	Signature
1	 Mrs. Snehal A. Narale	(Assistant Professor) Computer Science	
2	Mrs. Ruma R. Kapre	(Assistant Professor) Computer Science	
3	Mr. Roshan K. Thakre	(Assistant Professor) Mathematics	



CO ORDINATOR
INTERNAL QUALITY ASSURANCE CELL
DHARAMPETH, M. P. DEO MEMORIAL &
SCIENCE COLLEGE, NAGPUR



DHARAMPETH M. P. DEO MEMORIAL SCIENCE COLLEGE, NAGPUR
JUNIOR COLLEGE
2022-2023

Sl. No.	Name of Employee	Designation/Department	Signature
1	Mrs. Vijaya Mohan Kashikar	Vice Principal Lecturer ,Home-Science	
2	Mrs. Shobha Durgesh Zalke	Lecturer ,Physics	
3	Shri Shailendra. V. Walde	Lecturer ,Physics	
4	Dr. Arvind S. Kale	Lecturer ,Chemistry	
5	Shri Sunil Onkar Rathod	Lecturer ,Biology	
6	Dr. Rajesh R. Pashine	Lecturer ,Hindi	
7	Ms. Sujata Ali	Lecturer ,English	
8	Ms. Vishakha V. Kasikhedikar	Lecturer ,Sanskrit(Part-Time)	
9	Smt. Manasi M. Kanhe	Lecturer ,Chemistry	
10	Smt. Dipti G. Iyer	Lecturer ,Chemistry	
11	Shri Kishor S. Urkudkar	Lecturer ,Chemistry	
12	Ku. Swati Dinkar Apte	Lecturer ,Physics	
13	Smt. Sunita Anil Jawade	Lecturer ,Physics	
14	Ku. Archana Prabodh Ashtikar	Lecturer , Maths	
15	Dr Rahul D. Kalode	Lecturer , Phy. Education	
16	Ku. Prity L. Wankhede	Lecturer ,Biology (Part Time)	
17	Shri Homraj Khushal. Kolhe	Lecturer ,Mathematics	
18	Shri Bhalchandra Vijay. Deshkar	Lecturer ,Bifocal	
19	Shri Ajinkya Anil. Naphade	Lecturer ,Bifocal	
20	Mrs. Madhavi Anirudhsa Kundle	Lecturer ,Bifocal	
21	Dr. Mrs. Alka Jayant. Deosthale	Lecturer ,Bifocal	
22	Mrs. K.S.Kodape	Lecturer ,Bifocal	
23	Mrs. Bhagyashri Sarang Gurjar	Lecturer ,Bifocal	
24	Mrs. M.A. Zalke	Lecturer ,Bifocal	
25	Mrs. Priyanka Ganorkar	Lecturer ,Chemistry	
26	Mrs. Ashvini Shileder	Lecturer ,Chemistry	
27	Mrs. Payasvini Dhoke	Lecturer ,Physics	
28	Mrs. Shraddha Pande	Lecturer ,Chemistry Phy.	
29	Mrs. Ashwini Wannere	Lecturer ,Biology	
30	Mrs. Archana Dani	Lecturer ,Physics	
31	Mrs. Archana Gadewar	Lecturer ,Biology	
32	Mr. Mahesh S. Pendre	Lecturer ,Mathematics	
33	Mrs. Acharya	Lecturer , Marathi	
34	Mrs. Saxena	Lecturer , English	

CO ORDINATOR
INTERNAL QUALITY ASSURANCE CELL
DHARAMPETH, M. P. DEO MEMORIAL &
SCIENCE COLLEGE, NAGPUR

DHARAMPETH M. P. DEO MEMORIAL SCIENCE COLLEGE, NAGPUR
JUNIOR COLLEGE
2022-2023

M.C.V.C Teaching Staff

Sr. No.	Name of Employee	Designation/Department	
1	Mr.Shashimohan Vasantao Joshi	FIT (Electronics)	
2	Mr.Atul Bhalchandra Moghe	FIT (PR) (E.M.)	
3	Mr.Dinesh Sadashiv. Gulhane	FIT (PR) (Electronics)	

DHARAMPETH M. P. DEO MEMORIAL SCIENCE COLLEGE, NAGPUR
JUNIOR COLLEGE
Bifocal Teaching Staff

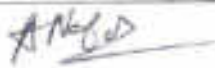
Sr. No.	Name of Employee	Designation/Department	Signature
1.	Shri Bhalchandra Vijay. Deshkar	Lecturer ,Bifocal	
2.	Shri Ajinkya Anil. Naphade	Lecturer ,Bifocal	
3.	Mrs. Madhavi Anirudhba Kundle	Lecturer ,Bifocal	
4.	Dr. Mrs. Alka Jayant. Deosthale	Lecturer ,Bifocal	
5.	Mrs.K.S.Kodape	Lecturer ,Bifocal	
6.	Mrs. Bhagyashri Sarang. Gurjar	Lecturer ,Bifocal	
7	Mrs.M.A.Zalke	Lecturer ,Bifocal	



CO ORDINATOR
INTERNAL QUALITY ASSURANCE CELL
DHARAMPETH, M. P. DEO MEMORIAL
SCIENCE COLLEGE, NAGPUR



DHARAMPETH M. P. DEO MEMORIAL SCIENCE COLLEGE, NAGPUR

**Non-Teaching Staff 2021-2022
(Senior College)**

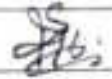

Sr. No.	Name of Employee	Designation/Department	Signature
1.	Mrs. Usha Arvind Wagh	Sr.Clerk	
2.	Shri Nirav. Vasantrao Bhalerao	Junior Clerk	
3.	Shri Anil Gajananrao Kada	Junior Clerk	
4.	Shri Sandeep Vijayrao. Dekate	Laboratory Assistant	
5.	Shri Ravindra Mohanrao Wadive	Laboratory Assistant	
6.	Shri Sudhir Yashwantrao Choudhari	Laboratory Assistant	
7.	Shri Pradeep Martandrao Ashtikar	Library Attendant	
8.	Shri Narendra Bhalchandra Tamboli	Library Attendant	
9.	Mrs. Prachi. Pramod Vishnu	Library Attendant	
10.	Shri Pritam Charandasji Nandeshwar	Library Attendant	
11.	Shri Deelip Ganpatrao Choudhari	Laboratory Attendant	
12.	Shri Deelip Pandurang Hodge	Laboratory Attendant	
13.	Shri Anil Nirturam Garkate	Laboratory Attendant	
14.	Shri Suresh Bhagwatrao. Choudhari	Laboratory Attendant	
15.	Shri Abhay Chandrashekhar Naik	Laboratory Attendant	
16.	Shri Shashank Anant Bangale	Laboratory Attendant	
17.	Shri Ajay Krushnarao Lanjewar	Laboratory Attendant	
18.	Shri Bhushan Beniram Pate	Laboratory Attendant	
19.	Shri Gulab. Dadaji Pajal	Laboratory Attendant	
20.	Shri Santosh Dattuji Maske	Laboratory Attendant	
21.	Shri Vidyadhar Anil Joshi	Laboratory Attendant	
22.	Shri Vinesh Narayan Ambade	Laboratory Attendant	
23.	Shri Kamlesh Bhimrao Buchunde	Laboratory Attendant	
24.	Smt. Rekha. Ramdas Katankar	Laboratory Attendant	
25.	Smt. Kala Rakesh Banafar	Laboratory Attendant	
26.	Smt. Vaishali Vasant Labde	Laboratory Attendant	

27.	Ku. Rupali Keshao Sahare	Laboratory Attendant	
28.	Shri Jitendra. Sheshrao Wankhede	Laboratory Attendant	
29.	Shri. Shriram Sudamji Paunikar	Laboratory Attendant	
30.	Shri Namdeo Narayan Nikhare	Peon	
31.	Shri Rajkumar Wamanrao Dethe	Peon	
32.	Shri Nivrutti Ramchandra Satpaise	Peon	
33.	Shri Parag Manoharrao Joshi	Peon	
34.	Shri. Gajanan Narayanrao Mohapekar	Peon	
35.	Shri. Amit Kumar	Library Attendant	
36.	Smt. Sarika P. Goje	Laboratory Assistant	
37.	Shri Aniket P. Siraswan	Laboratory Attendant	

MCVC. NON TEACHING STAFF

Sr. No.	Name of Employee	Designation/Department	
1	Mr. Sudir Krishnarao Hambarde	Jr. Clerk	
2	Mr. Deelip Pandurang Dhote	Peon	

Non-Teaching Staff Bifocal / No Grant

1	Mr. Kapil Dattatray Mandawar	Lab. Attd. Bifocal	
2	Mr. Anil Dadarao Jamthe	Lab. Attd. Bifocal	
3	Mr. Nikhil Vasanttrao Edlabadkar	Lab. Attd. Bifocal	
4	Mr. Anmol Mukunda Tambe	Peon, Bifocal	
5	Mr. Prabhu Namdeo Rao Bawane	Lab. Attd. Bifocal	
6	Mr. Prashant Nandkumar Chandrayan	Lab. Attd. Bifocal	
7	Mr. Nilesh U. Barange	Lab. Attd. Computer Science	

CO ORDINATOR
INTERNAL QUALITY ASSURANCE CELL
DHARAMPETH, M. P. DEO MEMORIAL &
SCIENCE COLLEGE



DHARAMPETH M. P. DEO MEMORIAL SCIENCE COLLEGE, NAGPUR
INTERNAL QUALITY ASSURANCE CELL (IQAC)

Activity Report

Date: 18/8/2022

Name of Organizing Department or Committee: 14th August , 2022 celebration committee

Name of the activity: Azadi ka Amrit Mohotsav

Suggested CRITERION point if any: Criteria I

Date of Activity: 14/08/2022

Place of Activity: Dharampeth M. P. Deo Memorial Science College Nagpur

Name of Guest Speaker/s or Judge/s or Chief Guest/s if any: Dr. Mrs Wanjari, Ex VC

Title of the Activity: Flag Hoisting (National Celebration)

Number of Participants: 77

Name of the Teacher In-charge / Convener: - Dr. Vaishali Meshram

Names of other Committee Members / Staff: Dr. Kalode, Dr. Lt. Ambekar , Mr. Atul Moghe

OUTCOME of the Activity with respect to mission vision of the institute and or academics:

On the eve of Azadi ka amrit Mahotsav of India, college celebrated in a manner befitting the occasion with NCC students and college staff, Rally was organised by NSS students. After the Flag hoisting Chief Guest Dr. Wanjari addressed the NCC students and all staff of college.

Activity with newspaper coverage if any: ----No

Activity data save in PC of: Chemistry



Prof. Pitambar Humane

IQAC Coordinator

CO ORDINATOR
INTERNAL QUALITY ASSURANCE CELL
DHARAMPETH, M. P. DEO MEMORIAL &
SCIENCE COLLEGE, NAGPUR

Name & Signature of Teacher In-charge

Dr. Akhilesh Peshwe

Principal

Principal
Dharampeth M.P. Deo Memorial
Science College, Nagpur.

Date: 14/08/2022

DHARAMPETH M. P. DEO MEMORIAL SCIENCE COLLEGE, NAGPUR.

Teaching Staff 2022-2023

(Sr.College)

Sr. No.	Name of Employee	Designation/Department	Signature
1.	Dr.Akhilesh V. Peshwe	Principal	
2.	Dr. Mrs. Varsha Vinod Rangari	(Associate Professor) Electronics	
3.	Dr. Pitambar. Tulshiram Humane	(Associate Professor) Botany	
4.	Dr. (Mrs.) Vidya. Ratan Katoke	(Associate Professor) Microbiology	
5.	Dr. (Mrs.) Kirti. Mangesh Paturkar	(Assistant Professor) Zoology	
6.	Dr. (Mrs.) Seema. Kiran Uhale	(Associate Professor) Physics	
7.	Lt.Dr. Prashant. Wamanrao Ambekar	(Associate Professor) Physics	
8.	Dr. (Mrs.) Vaishali. Pravin Meshram	(Associate Professor) Chemistry	
9.	Dr. Nitin Pravin Gaiwad	(Assistant Professor) Mathematics	
10.	Mrs. Manju Milind. Deshpande	(Associate Professor) Home Science	
11.	Dr. Mrs. Shradha. Abhijit Deshpande	(Assistant Professor) English	

Computer Science

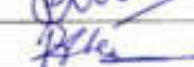
Sr. No.	Name of Employee	Designation/Department	Signature
1	Dr. Mrs. Snehal A. Narale	(Assistant Professor) Computer Science	
2	Mrs. Ruma R. Kapre	(Assistant Professor) Computer Science	
3	Mr. Roshan K. Thakre	(Assistant Professor) Mathematics	



CO ORDINATOR
INTERNAL QUALITY ASSURANCE CELL
DHARAMPETH, M. P. DEO MEMORIAL &
SCIENCE COLLEGE, NAGPUR

DHARAMPETH M. P. DEO MEMORIAL SCIENCE COLLEGE, NAGPUR
JUNIOR COLLEGE
2022-2023

Sr. No.	Name of Employee	Designation/Department	Signature
1	Mrs. Vijaya Mohan Kashikar	Vice Principal Lecturer ,Home-Science	
2	Mrs. Shobha Durgesh Zalke	Lecturer ,Physics	
3	Shri Shailendra. V. Walde	Lecturer ,Physics	
4	Dr. Arvind S. Kale	Lecturer ,Chemistry	
5	Shri Sunil Onkar Rathod	Lecturer ,Biology	
6	Dr. Rajesh R. Pashine	Lecturer ,Hindi	
7	Ms. Sujata Ali	Lecturer ,English	
8	Ms. Vishakha V. Kaskhedikar	Lecturer ,Sanskrit(Part-Time)	
9	Smt. Manasi M. Kanhe	Lecturer ,Chemistry	
10	Smt. Dipti G. Iyer	Lecturer ,Chemistry	
11	Shri Kishor S. Urkudkar	Lecturer ,Chemistry	
12	Ku. Swati Dinkar Apte (Joshi)	Lecturer ,Physics	
13	Smt. Sunita Anil Jawade	Lecturer ,Physics	
14	Ku. Archana Prabodh Ashtikar	Lecturer ,Maths	
15	Dr Rahul D. Kalode	Lecturer ,Phy. Education	
16	Ku. Prity L. Wankhede	Lecturer ,Biology (Part Time)	
17	Shri Homraj Khushal. Kolhe	Lecturer ,Mathematics	
18	Shri Bhalchandra Vijay. Deshkar	Lecturer ,Bifocal	
19	Shri Ajinkya Anil. Naphade	Lecturer ,Bifocal	
20	Mrs. Madhavi Anirudhsa Kundle	Lecturer ,Bifocal	
21	Dr. Mrs. Alka Jayant. Deosthale	Lecturer ,Bifocal	
22	Mrs. K.S.Kodape	Lecturer ,Bifocal	
23	Mrs. Bhagyashri Sarang. Gurjar	Lecturer ,Bifocal	
24	Mrs.M.A.Zalke	Lecturer ,Bifocal	
25	Mrs.Priyanka Ganorkar	Lecturer ,Chemistry	
26	Mrs.Ashvini Shiledar	Lecturer ,Chemistry	
27	Mrs.Payasvini Dhoke	Lecturer ,Physics	
28	Mrs.Shraddha Pande	Lecturer ,Chemistry Physics	
29	Mrs.Ashwini Wannere	Lecturer ,Biology	
30	Mrs.Archana Dani	Lecturer ,Physics	
31	Mrs.Archana Gadewar	Lecturer ,Biology	
32	Mr.Mahesh S. Pendre	Lecturer ,Mathematics	
33	Mrs.Acharya	Lecturer , Marathi	
34	Mrs.Saxena	Lecturer , English	

CO ORDINATOR
INTERNAL QUALITY ASSURANCE CELL
DHARAMPETH, M. P. DEO MEMORIAL &
SULP J. NAGPUR

DHARAMPETH M. P. DEO MEMORIAL SCIENCE COLLEGE, NAGPUR
JUNIOR COLLEGE
2022-2023

M.C.V.C Teaching Staff

Sr. No.	Name of Employee	Designation/Department	
1	Mr.Shashimohan Vasantao Joshi	FTT (Electronics)	
2	Mr.Atul Bhalchandra Moghe	FTT (PR) (E.M.)	Atul
3	Mr.Dinesh Sadashiv. Gulhane	FTT (PR) (Electronics)	

DHARAMPETH M. P. DEO MEMORIAL SCIENCE COLLEGE, NAGPUR
JUNIOR COLLEGE
Bifocal Teaching Staff

Sr. No.	Name of Employee	Designation/Department	Signature
1.	Shri Bhalchandra Vijay. Deshkar	Lecturer ,Bifocal	
2.	Shri Ajinkya Anil. Naphade	Lecturer ,Bifocal	Ajinkya
3.	Mrs. Madhavi Anrudhisa Kundle	Lecturer ,Bifocal	
4.	Dr. Mrs. Alka Jayant. Deosthale	Lecturer ,Bifocal	
5.	Mrs.K.S.Kodape	Lecturer ,Bifocal	
6.	Mrs. Bhagyashri Sarang. Gurjar	Lecturer ,Bifocal	
7	Mrs.MA.Zalke	Lecturer ,Bifocal	MZalke

CO ORDINATOR
INTERNAL QUALITY ASSURANCE CELL
DHARAMPETH, M. P. DEO MEMORIAL &
SCIENCE COLLEGE, NAGPUR

DHARAMPETH M. P. DEO MEMORIAL SCIENCE COLLEGE, NAGPUR

**Non-Teaching Staff 2021-2022
(Senior College)**

Sr. No.	Name of Employee	Designation/Department	Signature
1.	Mrs. Usha Arvind Wagh	St. Clerk	
2.	Shri Nirav. Vasantao Bhalerao	Junior Clerk	
3.	Shri Anil Gajananrao Kadu	Junior Clerk	
4.	Shri Sandeep Vijayrao. Dekate	Laboratory Assistant	
5.	Shri Ravindra Mohanrao Wadive	Laboratory Assistant	
6.	Shri Sudhir Yashwantrao Choudhari	Laboratory Assistant	
7.	Shri Pradeep Martandrao Ashtikar	Library Attendant	
8.	Shri Narendra Bhalchandra Tamboli	Library Attendant	
9.	Mrs. Prachi. Pramod Vishnu	Library Attendant	
10.	Shri Pritam Charandasji Nandeshwar	Library Attendant	
11.	Shri Deelip Ganpatrao Choudhari	Laboratory Attendant	
12.	Shri Deelip Pandurang Hadge	Laboratory Attendant	
13.	Shri Anil Nirturam Garkate	Laboratory Attendant	
14.	Shri Suresh Bhagwatrao. Choudhari	Laboratory Attendant	
15.	Shri Abhay Chandrashekhar Naik	Laboratory Attendant	
16.	Shri Shashank Anant Bangale	Laboratory Attendant	
17.	Shri Ajay Krushnarao Lanjewar	Laboratory Attendant	
18.	Shri Bhushan Beniram Patle	Laboratory Attendant	
19.	Shri Golab. Dadaji Pajai	Laboratory Attendant	
20.	Shri Santosh Dattuji Maske	Laboratory Attendant	
21.	Shri Vidyadhar Anil Joshi	Laboratory Attendant	
22.	Shri Vinesh Narayan Ambade	Laboratory Attendant	
23.	Shri Kamlesh Bhimrao Buchunde	Laboratory Attendant	
24.	Smt. Rekha. Ramdas Katankar	Laboratory Attendant	
25.	Smt. Kala Rakesh Banafar	Laboratory Attendant	
26.	Smt. Vaishali Vasant Labde	Laboratory Attendant	

CO ORDINATOR

**INTERNAL QUALITY ASSURANCE CELL
DHARAMPETH, M. P. DEO MEMORIAL &
SCIENCE COLLEGE, NAGPUR**

27.	Ku. Rupali Keshao Sahare	Laboratory Attendant	<i>RKS</i>
28.	Shri Jitendra. Sheshrao Wankhede	Laboratory Attendant	
29.	Shri Shriram Sudamp Paunikar	Laboratory Attendant	<i>(S)</i>
30.	Shri Namdeo Narayan Nihare	Peon	
31.	Shri Rajkumar Wamanrao Dethle	Peon	<i>R. Dethle</i>
32.	Shri Nivrutti Ramchandra Satpaise	Peon	<i>Agg. 2011/2012</i>
33.	Shri Parag Manoharrao Joshi	Peon	
34.	Shri. Gajanan Narayanao Mohapekar	Peon	
35.	Shri. Amit Kumar	Library Attendant	<i>K</i>
36.	Smt. Sarika P. Goje	Laboratory Assistant	<i>S. Goje</i>
37.	Shri Aniket P. Siraswan	Laboratory Attendant	<i>A. Siraswan</i>

MCVC NON TEACHING STAFF

Sr. No.	Name of Employee	Designation/Department	
1	Mr. Sudir Krushnarao Hambarde	Jr. Clerk	<i>S. Hambarde</i>
2	Mr. Deelip Pandurang Dhote	Peon	<i>D. Dhote</i>

Non-Teaching Staff Bifocal / No Grant

1	Mr. Kapil Dattatray Mandawar	Lab. Attd. Bifocal	
2	Mr. Anil Dadarao Jamthe	Lab. Attd. Bifocal	<i>A. Jamthe</i>
3	Mr. Nikhil Vasanttrao Edlabadkar	Lab. Attd. Bifocal	
4	Mr. Amol Mukunda Tambe	Peon, Bifocal	<i>A. Tambe</i>
5	Mr. Prabhu Namdeora Bawane	Lab. Attd. Bifocal	<i>P. Bawane</i>
6	Mr. Prashant Nandkumar Chandrayan	Lab. Attd. Bifocal	
7	Mr. Nilesh U. Barange	Lab. Attd. Computer Science	

(Signature)

CO ORDINATOR
INTERNAL QUALITY ASSURANCE CELL
DIJARANIPETH, M. P. DEO MEMORIAL &



DHARAMPETH M. P. DEO MEMORIAL SCIENCE COLLEGE,
North Ambazari Road, Near Ambazari Lake, Nagpur- 440033

DATA VALIDATION & VERIFICATION (DVV)

Name of the Programme : Flag Hoisting and Rally on 14th August 2022.
Date of the Programme : 14th August 2022.
Name of Chief Guest if any : Dr. Wanjari (ex-VC Mumbai)
Name of Guest Speaker if any : _____

Sr. No.	Name of the Participant	Mobile Number	E-mail Id	Signature
01	SAHIL SINGH	7258868502	sahilsingh06@gmail	
02	Vaidhnavi Gadge	9022976449	gadgenvaidhnavi@gmail.com	
3	Gargi Nadge	7972076671	garginadge@govind.com	
4	Milsh Hulke	8624091652	hulkenilsh.com	
5	Vedant Baxy	9530452796	vedantbaxy@gmail.com	
6	Harsh Kodape	9604677672	harshkodape@gmail.com	
7	Monal Sonke	7218096432		
8	Hemisha Navneet	9503208834		
9	chetna Bhopre	9021058104		
10	Nikita Bayapatne	7058625053		

Signature of:

Programme In-charge

IQAC Coordinator
CENTRAL QUALITY ASSURANCE CELL
DHARAMPETH M. P. DEO MEMORIAL &
SCIENCE COLLEGE, NAGPUR

Principal
Dharampeth M.P. Deo Memorial
Science College, Nagpur.



DHARAMPETH M. P. DEO MEMORIAL SCIENCE COLLEGE,
North Ambazari Road, Near Ambazari Lake, Nagpur- 440033

DATA VALIDATION & VERIFICATION (DVV)

SR No	Name	Mob	Signature
01	Pratik D. Lilhare	9307480168	Pratik
02	Shreyash B. Chatte	8446354089	Shreyash
03	CDT Peachit. R. Kotpalliwale	7498102097	Pechit
04	CDT Rohit Wanjari	7741061907	Rohit
05	CDT Anuj Mishra	8103656208	Anuj Mishra
06	CDT Vatan Sonwane	9975410965	Vatan
07	CDT Sudhanshu Vitke	7028429173	Sudhanshu
08	Pranav Ravi Choudhari	7822804584	Pranav
09	Pritam Surendra Kature	8010793204	Pritam
10	Aniket Bawankar	9767219301	Aniket
11	Atul Thakre	9881956597	Atul
12	Tejas Chelmalwar	9604662119	Tejas
13	Surej Mishra	9730639023	Surej
14	Akshay Singh	9375971260	Akshay

Wcc

Signature of: _____

Programme In-charge



CO ORDINATOR
INTERNAL QUALITY ASSURANCE CELL
DHARAMPETH, M. P. DEO MEMORIAL
SCIENCE COLLEGE, NAGPUR

Principal

Dharampeth M.P. Deo Memorial
Science College, Nagpur.



DHARAMPETH M. P. DEO MEMORIAL SCIENCE COLLEGE,
North Ambazari Road, Near Ambazari Lake, Nagpur- 440033

NCC

DATA VALIDATION & VERIFICATION (DVV)

15	Jasraj Patilwal	9370820325		<u>J.P.</u>
16	Aman Mishra	7997840945		<u>A.M.</u>
17	Prachi Waghule	8767914118		<u>P.W.</u>
18	Sufriya Patle	7757871925		<u>S.P.</u>
19	Shefali Sahu	9164117136		<u>S.S.</u>
20	Bhumika Chedje	8830391103		<u>B.C.</u>
21	Abhishek Ranjani	8329347806		<u>A.R.</u>
22)	Poonam Chaurasia	8767765121		<u>P.C.</u> (NCC)
23	Vidhanshu Jaisankar	8623810732		<u>V.J.</u> (NCC)
24)	Pratwal S. Maruya	7350870326		<u>P.M.</u>
25)	Nimish G. Naugrao	9689378735		<u>N.G.</u>
26)	Aditya Pedkerale	9896327348		<u>A.P.</u>
27)	Rishabh Pandey	7972868378		<u>R.P.</u>
28)	Saurav Pandey	8600244439		<u>S.P.</u>
29)	Manthan Jodari	7020463916		<u>M.J.</u> (NCC)

S. Prakash
Signature of:

Programme In-charge

[Signature]

CO ORDINATOR
INTERNAL QUALITY ASS. CELL
DHARAMPETH, M. P. DEO MEMORIAL &
SCIENCE COLLEGE, NAGPUR

[Signature]

Principal
PRINCIPAL
Dharampeth M.P. Deo Memorial
Science College, Nagpur-440033



DHARAMPETH M. P. DEO MEMORIAL SCIENCE COLLEGE,
North Ambazari Road, Near Ambazari Lake, Nagpur- 440033

DATA VALIDATION & VERIFICATION (DVV)

	Utkti Name	Mob.		Sing
30)	vicki Maraskalhe	8806289584		Ⓜ.
31)	Rutuja Chivrewar	9156461497		Rutuja
32)	Kajal Bhange	9284059210		Kajal
33	Jayashree Bhandit	8080461598		J. Bhandit
34	Ayush Yele	8805265978		Ⓜ.
35	Ved. S. Chavdhary	7498572766		Ⓜ.
36	Utkarsh Nandeshwar	8983782258		Ⓜ.
37	Khumesh Sidam	9307391945		Ⓜ.
38	Sumit Achare	9356293570		Ⓜ.
39	Rishu Bagde	9511654238		Ⓜ.
40	Khushi Pali	8767607224		Ⓜ.
41	Ikshu Pali	8459565214		Ⓜ.
42	Dharmaputi Late	9975037356		Ⓜ.
43	Pranali Dehankar	8267581278		Ⓜ. R.D

Signature of:

Programme In-charge

CO ORDINATOR
INTERNAL QUALITY ASSURANCE CELL
DHARAMPETH, M. P. DEO MEMORIAL
SCIENCE COLLEGE, NAGPUR

Principal
PRINCIPAL

Dharampeth M.P. Deo Memorial
Science College, Nagpur-440033



DHARAMPETH M. P. DEO MEMORIAL SCIENCE COLLEGE,
North Ambazari Road, Near Ambazari Lake, Nagpur- 440033

DATA VALIDATION & VERIFICATION (DVV)

44	Tushal Achare	9075995617		
45	Vinay. mukesh. singh	8556987255		
46	Riddhi Abhay Rajkarne	9668974021		
47	Vaidhvee Baburao Gargad	9507907278		
48	Nidhi Deepak Hiranwar	9620754629		
49	Dhruv. Manoj Sangtani	8956264601		
50	Vaishali Mahesh Sabare	7972925403		
51	Kishorwari R. Pushptode	8624976072		
52	Shreya Gurusdas Bhimte	9798124241		
53	Madhura Umesh Bhondare	8767484914		
54	Sayli Gevanand Lakhade	9356413804		
55	Rinam charandas Wankhede	8010966529		
56	Vaidhvi Sanjay Meshram	9850212365		
57	Aditi Singh	8010785732		
58	Divyanshi Thoran	9309921883		
59	Tanushree Kohade	9075625334		

Signature of:

Programme In-charge

COORDINATOR
INTERNAL COORDINATION ASSURANCE CELL
DHARAMPETH, M. P. DEO MEMORIAL &
SCIENCE COLLEGE, NAGPUR

Principal
Dharampeth M.P. Deo Memorial
Science College, Nagpur-440033



DHARAMPETH M. P. DEO MEMORIAL SCIENCE COLLEGE,
North Ambazari Road, Near Ambazari Lake, Nagpur- 440033

DATA VALIDATION & VERIFICATION (DVV)

61	Ashlesha Sangole	9503998469		Sangole
62	Manisha Yadav	9373140879		Yadav
63	Khushabu Chaudhary	7262074960	khushabuchaudhary@gmail.com	Chaudhary
64	Devashri Bisen	8698119078		DBisen
65	Vaideshi Chitambar	8308115508	V	Vaideshi
66	Shruti Dongre	7841928657		Shruti
67	Purva Rajput	7498614295		Rajput
68	Megha Manna	7028312979		Manna
69	Sanjivudhi Devgode	9021403782		Sanjivudhi
70	Adarsh Bhautekar	8999106998		Bhautekar
71	Prasheek Ingale	8830303579		Prasheek Ingale
72	Prasheek Wankhede	9573916186		Wankhede
73	Kajal Gupta	8857964086		Gupta
74	Arushika Kawale	7249808293		Kawale
75	Dnyani Raut	9145523682		Dnyani

Signature of:

Programme In-charge

CO-ORDINATOR
INTERNAL QUALITY ASSURANCE CELL
DHARAMPETH, M. P. DEO MEMORIAL
SCIENCE COLLEGE, NAGPUR

P. T. O.
PRINCIPAL
Dharampeth M.P. Deo Memorial
Science College, Nagpur-440033



DHARAMPETH M. P. DEO MEMORIAL SCIENCE COLLEGE, NAGPUR
INTERNAL QUALITY ASSURANCE CELL (IQAC)
Activity Report

Date: 18/8/2022

Name of Organizing Department or Committee: 15th August , 2022 celebration committee

Name of the activity: Azadi ka Amrit Mohotsav

Suggested CRITERION point if any: Criteria I

Date of Activity: 15/08/2022

Place of Activity: Dharampeth M. P. Deo Memorial Science College Nagpur

Name of Guest Speaker/s or Judge/s or Chief Guest/s if any:

Title of the Activity: Flag Hoisting (National Celebration)

Number of Participants: 43

Name of the Teacher In-charge / Convener: - Dr. Vaishali Meshram

Names of other Committee Members / Staff: Dr. Kalode, Dr. Lt. Ambekar , Mr. Atul Moghe

OUTCOME of the Activity with respect to mission vision of the institute and or academics:

This year also the Independence Day is celebrated with grandeur, gaiety, and enthusiasm.

On the eve of Azadi ka amrit Mahotsav of India, college celebrated in a manner befitting the occasion with NCC students and college staff . After the Flag hoisting Chief guest addressed the NCC students and all staff of college .

Activity with newspaper coverage if any: ----No

Activity data save in PC of: Chemistry



Prof. Pitambar Humane

IQAC Coordinator

COORDINATOR
INTERNAL QUALITY ASSURANCE CELL
DHARAMPETH, M. P. DEO MEMORIAL &
SCIENCE COLLEGE, NAGPUR

Name & Signature of Teacher In-charge

Dr. Akhilesh Peshwe

Principal

PRINCIPAL









Dharampeth M.P. Deo Memorial
Science College, Nagpur-440033

15 August 2022



DHARAMPETH M. P. DEO MEMORIAL SCIENCE COLLEGE, NAGPUR.

Teaching Staff 2022-2023

(Sr.College)

Sr. No.	Name of Employee	Designation/Department	Signature
1.	Dr. Akhilesh V. Peshwe	Principal	
2.	Dr. Mrs. Varsha Vinod Rangari	(Associate Professor) Electronics	
3.	Dr. Pitambar. Tulshiram Humane	(Associate Professor) Botany	
4.	Dr. (Mrs.) Vidya. Ratan Katoke	(Associate Professor) Microbiology	
5.	Dr. (Mrs.) Kirti. Mangesh. Patilkar	(Assistant Professor) Zoology	
6.	Dr. (Mrs.) Seema. Kiran Ubale	(Associate Professor) Physics	
7.	LLDr. Prashant. Wamanrao Ambekar	(Associate Professor) Physics	
8.	Dr. (Mrs.) Vaishali. Pravin Meshram	(Associate Professor) Chemistry	
9.	Dr. Nitin Pravin Gawkwad	(Assistant Professor) Mathematics	
10.	Mrs. Manju Milind. Deshpande	(Associate Professor) Home Science	
11.	Dr. Mrs. Shradha. Abhijit Deshpande	(Assistant Professor) English	

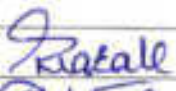
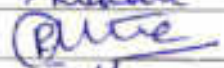
Computer Science

Sr. No.	Name of Employee	Designation/Department	Signature
1	Mrs. Snehal A. Narale	(Assistant Professor) Computer Science	
2	Mrs. Ruma R. Kapre	(Assistant Professor) Computer Science	
3	Mr. Roshan K. Thakre	(Assistant Professor) Mathematics	

DHARAMPETH M. P. DEO MEMORIAL SCIENCE COLLEGE, NAGPUR
JUNIOR COLLEGE

2020-2021

Sr. No.	Name of Employee	Designation/Department	Signature
1	Mrs. Vijaya Mohan Kashikar	Vice Principal Lecturer ,Home-Science	UMB
2	Mrs. Shobha Durgesh Zalke	Lecturer ,Physics	Shobha
3	Shri Shailendra. V. Walde	Lecturer ,Physics	Shri Walde
4	Dr. Arvind S. Kale	Lecturer ,Chemistry	A.S.Kale
5	Shri Sunil Onkar Rathod	Lecturer ,Biology	Sunil Rathod
6	Dr. Rajesh R. Pashine	Lecturer ,Hindi	Rajesh Pashine
7	Ms. Sujata Ali	Lecturer ,English	Sujata Ali
8	Ms. Vishakha V. Kaskhedikar	Lecturer ,Sanskrit(Part-Time)	Vishakha
9	Smt. Manasi M. Kanhe	Lecturer ,Chemistry	Manasi Kanhe
10	Smt. Dipti G. Iyer	Lecturer ,Chemistry	Dipti Iyer
11	Shri Kishor S. Urkudkar	Lecturer ,Chemistry	Kishor Urkudkar
12	Ku. Swati Dinkar Apte	Lecturer ,Physics	Swati Apte
13	Smt. Sunita Anil Jawade	Lecturer ,Physics	Sunita Jawade
14	Ku. Archana Prabodh Ashtikar	Lecturer , Maths	Archana Ashtikar
15	Dr Rahul D. Kalode	Lecturer , Phy. Education	Rahul Kalode
16	Ku. Prity L. Wankhede	Lecturer ,Biology (Part Time)	Prity Wankhede
17	Shri Homraj Khushal. Kolhe	Lecturer ,Mathematics	Homraj Kolhe
18	Shri Bhalchandra Vijay. Deshkar	Lecturer ,Bifocal	Bhalchandra Deshkar
19	Shri Ajinkya Anil. Naphade	Lecturer ,Bifocal	Ajinkya Naphade
20	Mrs. Madhavi Aniradhsa Kundle	Lecturer ,Bifocal	Madhavi Kundle
21	Dr. Mrs. Alka Jayant. Deosthale	Lecturer ,Bifocal	Alka Deosthale
22	Mrs.K.S.Kodape	Lecturer ,Bifocal	K.S.Kodape
23	Mrs. Bhagyashri Sarang. Gurjar	Lecturer ,Bifocal	Bhagyashri Gurjar
24	Mrs.M.A.Zalke	Lecturer ,Bifocal	M.A.Zalke
25	Mrs.Priyanka Ganorkar	Lecturer ,Chemistry	Priyanka Ganorkar
26	Mrs.Ashvini Shiledar	Lecturer ,Chemistry	Ashvini Shiledar
27	Mrs.Payasvini Dhoke	Lecturer ,Physics	Payasvini Dhoke
28	Mrs.Shraddha Pande	Lecturer ,Chemistry	Shraddha Pande
29	Mrs.Ashwini Wannere	Lecturer ,Biology	Ashwini Wannere
30	Mrs.Archana Dani	Lecturer ,Physics	Archana Dani
31	Mrs.Archana Gadewar	Lecturer ,Biology	Archana Gadewar
32	Mr.Mahesh S. Pendre	Lecturer ,Mathematics	Mahesh Pendre
33	Mrs.Acharya	Lecturer , Marathi	Acharya
34	Mrs.Saxena	Lecturer , English	Saxena

DHARAMPETH M. P. DEO MEMORIAL SCIENCE COLLEGE, NAGPUR

**Non-Teaching Staff 2022-2023
(Senior College)**

Sr. No.	Name of Employee	Designation/Department	Signature
1.	Mrs. Usha Arvind Wagh	Sr.Clerk	
2.	Shri Nirav. Vasanttrao Bhalerao	Junior Clerk	
3.	Shri Anil Gajananrao Kadu	Junior Clerk	
4.	Shri Sandeep Vijayrao. Dekate	Laboratory Assistant	
5.	Shri Ravindra Mohanrao Wadive	Laboratory Assistant	
6.	Shri Sudhar Yashwantrao Choudhari	Laboratory Assistant	
7.	Shri Pradeep Martandrao Ashtikar	Library Attendant	
8.	Shri Narendra Bhalchandra Tamboli	Library Attendant	
9.	Mrs. Prachi. Pramod Vishnu	Library Attendant	
10.	Shri Pritam Charandasji Nandeshwar	Library Attendant	
11.	Shri Deelip Ganpatrao Choudhari	Laboratory Attendant	
12.	Shri Deelip Pandurang Hodge	Laboratory Attendant	
13.	Shri Anil Nirturam Garkate	Laboratory Attendant	
14.	Shri Suresh Bhagwatrao. Choudhari	Laboratory Attendant	
15.	Shri Abhay Chandrashekhar Naik	Laboratory Attendant	
16.	Shri Shashank Anant Bangale	Laboratory Attendant	
17.	Shri Ajay Krushnarao Lanjewar	Laboratory Attendant	
18.	Shri Bhushan Beniram Patle	Laboratory Attendant	
19.	Shri Gulab. Dadaji Pajai	Laboratory Attendant	
20.	Shri Santosh Dattuji Maske	Laboratory Attendant	
21.	Shri Vidyadhar Anil Joshi	Laboratory Attendant	
22.	Shri Vinesh Narayan Ambade	Laboratory Attendant	
23.	Shri Kamlesh Bhimrao Buchunde	Laboratory Attendant	
24.	Smt. Rekha. Ramdas Katankar	Laboratory Attendant	
25.	Smt. Kala Rakesh Banafar	Laboratory Attendant	
26.	Smt. Vaishali Vasant Labde	Laboratory Attendant	

27.	Ka. Rupali Keshao Sahare	Laboratory Attendant	<i>RK</i>
28.	Shri Jitendra. Sheshrao Wankhede	Laboratory Attendant	<i>J.W.</i>
29.	Shri. Shriram Sudamji Paunikar	Laboratory Attendant	<i>(S)</i>
30.	Shri Namdeo Narayan Nikhare	Peon	
31.	Shri Rajkumar Wamanrao Dethe	Peon	<i>R.D.</i>
32.	Shri Nivrutti Ramchandra Sutpaise	Peon	
33.	Shri Parag Mattoharrao Joshi	Peon	<i>P.J.</i>
34.	Shri. Gajanan Narayanrao Mohapekar	Peon	
35.	Shri. Amit Kumar	Library Attendant	<i>A.K.</i>
36.	Smt. Sarika P. Goje	Laboratory Assistant	<i>S.P.G.</i>
37.	Shri Aniket P. Siraswan	Laboratory Attendant	<i>A.P.S.</i>

MCVC NON TEACHING STAFF

Sr. No.	Name of Employee	Designation/Department	
1	Mr. Sudir Krishnarao Hambarde	Jr. Clerk	
2	Mr. Deelip Pandurang Dhote	Peon	<i>D.D.</i>

Non-Teaching Staff Bifocal / No Grant

1	Mr. Kapil Dattatray Mandawar	Lab. Attd. Bifocal	<i>K.M.</i>
2	Mr. Anil Dadarao Jamthe	Lab. Attd. Bifocal	<i>A.J.</i>
3	Mr. Nikhil Vasantao Gadlabadkar	Lab. Attd. Bifocal	
4	Mr. Amol Mukunda Tambe	Peon, Bifocal	<i>A.T.</i>
5	Mr. Prabhu Namdeo Rao Bawane	Lab. Attd. Bifocal	
6	Mr. Prashant Nandkumar Chandrayan	Lab. Attd. Bifocal	<i>P.N.C.</i>
7	Mr. Nilesh U. Baringe	Lab. Attd. Computer Science	

D. S. Lulkare
A. B. Moghe

H.C. V.K.
—

S.S.
M.B.



DHARAMPETH M. P. DEO MEMORIAL SCIENCE COLLEGE,
North Ambazari Road, Near Ambazari Lake, Nagpur- 440033

DATA VALIDATION & VERIFICATION (DVV)

Name of the Programme : Azadi Ka Amul: Mohatsav, 15th August celebration
Date of the Programme : 15/08/2022
Name of Chief Guest if any : _____
Name of Guest Speaker if any : _____

Sr. No.	Name of the Participant	Mobile Number	E-mail Id	Signature
1	Shrutika Ratiram Borkar	9067350845	shrutikaborkar@gmail.com	SS Borkar
2	Vishakha Devidas Ballabde	8329639834	VishakhaBallabde@gmail.com	VBallabde
3	Bhumika Vinod Thakre	7218249917	Bhumikathakre@gmail.com	Bhumika
4	Kavita Sunil Mishra	9657199261	km783285@gmail.com	Kavita
5	Rutik V. Gajbhiye	7620826960	rutikgajbhiye@gmail.com	Rutik
6	Ritik M. Varma	9358744234	ritikug29@gmail.com	Ritika
7	Pooja .S. Itankar	9156973252	poojaitankar@gmail.com	Pooja
8	Prasanna S. Bhojari	8010434634	Prasanna6738@gmail.com	Prasanna
9	Khushi N. Suryawanshi	7972437504	khushisuryawanshi1189@gmail.com	Khushi
10	Aditye A. Mishra	7218484186	adityemishra3933@gmail.com	Aditye

Signature of:

Programme In-charge

IQAC Coordinator

CO ORDINATOR

INTERNAL QUALITY ASSURANCE CELL
DHARAMPETH, M. P. DEO MEMORIAL &
SCIENCE COLLEGE, NAGPUR

Principal

PRINCIPAL

Dharampeth M.P. Deo Memorial
Science College, Nagpur-440033



DHARAMPETH M. P. DEO MEMORIAL SCIENCE COLLEGE,
North Ambazari Road, Near Ambazari Lake, Nagpur- 440033

DATA VALIDATION & VERIFICATION (DVV)

1	Vaishnavi Nandhure	9322438316	Vaishnavi.nandhure36@gmail.com	
2	Ketaki Kirpal	9112759066	ketakikirpal14@gmail.com	
3	Srushti Vaidya	07872245658	srushtivaidya@gmail.com	
4	Anushree Chandel	9145621751	Anushreechandel@gmail.com	
5	Gauri A. Raut	9767813447	ankuraut2003@gmail.com	
6	Affina R. Sheikh	8080083981	affinasheikh973@gmail.com	
7	Rupesh Bhokre	88058873708	bhokre Rupesh@gmail.com	
8	Pratiksha Dalkar	902895716	cdalkar1992@gmail.com	
9	Niket Dhakre	7379999077	niketdhakre@-11-	
10	Shrawani Warkhede	7058368837	shrawanikar-	
11	Khushabu H. Choudhari	7262074960	khushabuchoudhari25@gmail.com	
12	Nikita S. Bhave	7820812749	nikitabhave98@gmail.com	
13	Sweeti S. Longadje	8390516517	sweetilongadje@gmail.com	
14	Deesh S. Longadje	9326246453	Deeshlongadje@gmail.com	
15	Prachi Mestani	8125189035	Prachimestani@gmail.com	
16	Pratiksha S. Navghare	8623033760	Navgharepratiksha@gmail.com	

Signature of:

Programme In-charge

IQAC Coordinator
CO ORDINATOR

INTERNAL QUALITY ASSURANCE CELL
DHARAMPETH, M. P. DEO MEMORIAL &
SCIENCE COLLEGE, NAGPUR

Principal
PRINCIPAL

Dharampeth M.P. Deo Memorial
Science College, Nagpur-440033



DHARAMPETH M. P. DEO MEMORIAL SCIENCE COLLEGE,
North Ambazari Road, Near Ambazari Lake, Nagpur- 440033

DATA VALIDATION & VERIFICATION (DVV)

17	Shital G. Bankar	7758055139	Shitalbankar122@gmail.com	S.G. Bankar
18	Aniket Kulkade	7709629106	Aniketkulkade78@gmail.com	Aniket
19	Vaishnavi Kapse	8983751089	Vaishnavikapse05@gmail.com	Vaishnavi
20	Sagar S. Bawane	9975460979	Sagarbawane137@gmail.com	S.Bawane
21	Shreya S. Bagde	8669883639	bagde@shreya78@gmail.com	S.Bagde
22	Riya R. Kulmethe	7420956528	Riyakulmethe12@gmail.com	Riya
23	Ashwini Ramteke	8857031895	ashwini981@gmail.com	Ashwini
24	Rushali Bhoskar	8857031895	rushali@gmail.com	Rushali
25	Dharmapuri R. Lale	9975037356	dharmapuri@raj@gmail.com	Dharmapuri
26	Ruchika N. Patle	8669335907	ruchikapatle4@gmail.com	R.Patle
27	Shubham Bisen	7448289544	shubham.bisen@gmail.com	Shubham
28	Ashmit N. Jivan	8080238161	ashmitjivan@gmail.com	Ashmit
29	Swanandi N. Dharne	7420880982	Swanandi.dharne@gmail.com	S.Dh.
30	Anjali A. Mishra	9325604513	anjalmishra4956@gmail.com	Anjali
31	Shikha J. Yadav	7262881320	Shikha.yadav@gmail.com	S.J.Yadav
32	Shruti P. Masram	8308657972	shrutimasram@gmail.com	Shruti

Signature of:

Programme In-charge

IQAC Coordinator

CO ORDINATOR
INTERNAL QUALITY ASSURANCE CELL
DHARAMPETH M. P. DEO MEMORIAL &
SCIENCE COLLEGE, NAGPUR

Principal
PRINCIPAL

Dharampeth M.P. Deo Memorial
Science College, Nagpur-440033



DHARAMPETH M. P. DEO MEMORIAL SCIENCE COLLEGE,
North Ambazari Road, Near Ambazari Lake, Nagpur- 440033

DATA VALIDATION & VERIFICATION (DVV)

33	Muskan R. Yadav	9579492617	muskan.yadav1225@gmail.com	Muskan
34	Anchal S. Singh	7875537925	Santosh.singh23923@gmail.com	Anchal
35	Chirayu B. Dolas	8010135012	chirayudolas22@gmail.com	Chirayu
36	Divya Kailash Hanote	8605422901	divyahanote0406@gmail.com	Divya
37	Juhi S Chaudhari	8669248944	chaudharijuhi2@gmail.com	Juhi
38	Jagruti D. Warkar	7447366023	jagrutiwarkar09@gmail.com	Jagruti
39	Asmita D. Chanjan	7387005792	asmitachanjan2@gmail.com	Asmita
40	Ankita Manoj Mishra	9421293176	mishraankita4653@gmail.com	Ankita
41	Kalyani C. Shahare	9307096378	Shahare Kalyani S@gmail.com	Kalyani
42	Pradumna A. Singh	7666939940	hardh.singh1234@gmail.com	Pradumna
43	Jitendra G. Ratone	9657459925	Jitendrasratone0236@gmail.com	Jitendra
44	Dhanshree Y. Newalkar	9356516280	newalkardhanshree@gmail.com	Dhanshree
45	Vaishnavi R. Lakhe	8869594804	chhakuli.lakhe536@gmail.com	Vaishnavi
46	Chhakuli Y. Wadikar	9325047907	chhakuliwadikar@gmail.com	Chhakuli
47	Twinkal Y. Lokhande	8959776609	twinkal.lokhande@gmail.com	Twinkal

Signature of:

Programme In-charge

IQAC Coordinator
CO ORDINATOR

INTERNAL QUALITY ASSURANCE CELL
DHARAMPETH M. P. DEO MEMORIAL &
SCIENCE COLLEGE, NAGPUR

Principal
PRINCIPAL

Dharampeth M. P. Deo Memorial
Science College, Nagpur-440033



DHARAMPETH M. P. DEO MEMORIAL SCIENCE COLLEGE, NAGPUR
INTERNAL QUALITY ASSURANCE CELL (IQAC)
Activity Report

Date: 31/08/2022

Name of Organizing Department or Committee: Deeksharambha - Induction Programme
22-23 Committee

Name of the activity: Deeksharambha - Induction Programme 22-23

Suggested CRITERION point if any: Criteria V

Date of Activity: 17th August 2023 to 23rd August 2023

Place of Activity: Online

Name of Guest Speaker/s or Judge/s or Chief Guest/s if any: List attached

Title of the Activity: Deeksharambha - Induction Programme 22-23

Number of Participants: Approx. 100

Name of the Teacher In-charge / Convener: Dr. Shraddha Deshpande

Names of other Committee Members / Staff: List Attached

OUTCOME of the Activity with respect to mission vision of the institute and or academics:

The Induction Programme aimed at motivating, inspiring and enlightening new students to achieve their future goals. Topics from career opportunities, value addition, importance of Gender equity, students' scholarships and welfare schemes and departmental associations.

Activity with newspaper coverage if any: Nil

Activity data save in PC of: English Department

Prof. Pitambar Humane
IQAC Coordinator

CO ORDINATOR
INTERNAL QUALITY ASSURANCE CELL
DHARAMPETH, M. P. DEO MEMORIAL &
SCIENCE COLLEGE, NAGPUR

Name & Signature of Teacher In-charge

Dr. Akhilesh Peshwe
Principal

Principal
Dharampeth M.P. Deo Memorial
Science College, Nagpur.



Dharampeth M. P. Deo Memorial Science College, Nagpur
Deeksharambha: Induction Programme 2022-23

SCHEDULE

	17th August 2022	Wednesday	Resource Person	Facilitator
	Time	Activity		
I	10.30 a.m. to 12.00 p.m	Principal's Address and Departmental Interaction	Dr. Akhilesh Peshwe	Dr. Mrs. S.A. Deshpande
II	12.00 p.m to 12.45 p.m	Traffic Awareness Programme	PSI RAS, Cons,Mishra	Dr. Rahul Kalode
III	1.00 p.m to 2.00 p.m	Basics and Career Opportunities in Physics and Botany	Prof.Mrs.Seema Ubale Prof.P.T Humane	
IV	2.00 p.m to 3.00 p.m	Time Table , NCC, Innovation and Incubation, Mentor Mentee, NSS , Life Long Learning	Lt. Dr. P. W. Ambekar Prof. P. T. Humane Dr.Mrs.V.P.Meshram	Dr. N. P. Gaikwad
	18th August 2022	Thursday	Resource Person	Facilitator
	Time	Activity		
I	11.00 a.m - 12.00 p.m	Lecture on Intellectual Property Rights (IPR)	Lt. Dr. P. W. Ambekar	Dr.Mrs.V.V Rangari
II	12.00 p.m. to 12.30 p.m	Training Placement and Career Guidance Cell, Women Cell, Cultural and Extracurricular Activities Committee, College Magazine, Grievence Redressal Cell, Cell against Sexual Harrassment	Dr.Mrs.Shraddha Deshpande Dr.Rajesh Pashine Prof.Mrs.V.V Rangari Mrs.M.M.Deshpande	Dr.Mrs.S.A. Deshpande
IV	12.30 onwards	Visit to Raman Science Centre		All Teachers
	19th August 2022	Friday	Resource Person	Facilitator
	Time	Activity		
I	11.30 to 12.30 p.m.	Basics and Career Opportunities in Mathematics	Dr. N. P. Gaikwad	
II	12.30 p.m. to 1.30 p.m.	Career Opportunities through MPSC/UPSC Examinations	Dr.Suresh Jadhav	Mr.Roshan Thakre
III	1.30 p.m to 2.30 p.m.	Basics and Career Opportunities in Statistics	Dr. Mrs. Jyoti Shivalkar	
IV	2.30 p.m to 3.30 p.m	Interaction with Rotaract Club	Rtr. Shardul Moharil	Dr.Mrs.Snehal Narale
	20th August 2022	Saturday	Resource Person	Facilitator
	Time	Activity		
I	11.30 p.m. to 12.30 p.m	Basics and Career Opportunities in Electronics and Microbiology	Dr.Mrs. V.V.Rangari Dr.Mrs.V.R.Kathoke	
..	12.30 p.m to - 1.30 p.m	Importance of Organ Donation (Organ Donation	Dr. Ravi Wankhede, Mohan Foundation,	Prof.P.T. Humane

IV	2.45 p.m to 3.30 p.m	Departmental Visits:	Computer Science and SCOM, ECOM, PCOM	Dr.Mrs.S.A.Narale
			Zoology:CZM, CZB	Dr.Mrs.K.M.Paturkar
			Physics: F7,F8 (PCM)	Prof.Mrs.Seema Ubale
			Chemistry: F9 (PCM)	Dr.Mrs.V.P.Meshram
			Botany: CBM	Prof.P.T. Humane
	22th August 2022	Monday	Resource Person	Facilitator
	Time	Activity		
I	11.00 a.m - 12.00 noon	Financial Literacy and Financial Planning (How to become Billionaire in 20 YEARS?)	Ms.Shivani Dani	Dr.Mrs.Vaishali Meshram
II	12.30. p.m to 1.30 p.m	Basics and Career Opportunities in Computer Science and Zoology	Dr.Mrs.S.A.Narale and Dr.Mrs.K.M.Paturkar	
III	1.30 p.m to 2.30 p.m	IIT Spoken Tutorial and Bioinformatics Course and Mushroom Cultivation	Dr.Mrs.Snehal Narale Prof.P.T.Humane	
IV	2.30 p.m to 3.30 p.m	Departmental Visits:	Electronics: PME, ECOM	Prof.Mrs.V.V Rangari
			Microbiology: CZM, CBM	Dr.Mrs.V.V. Kathoke
			Physics : F9 PCM , PCOM	Prof.Mrs.Seema Ubale,
			Chemistry: F7,F8 (PCM)	Dr.Mrs.V.P.Meshram
			Botany: CBZ	Prof.P.T. Humane
	23th August 2022	Tuesday	Resource Person	Facilitator
	Time	Activity		
I	11.00 a.m - 12.00 noon	Time to meet your best version	Mr.Vinay Chawla	Mrs.Ruma Kapre
II	12.00 a.m. to 12.45 p.m.	NIRMAN : Youth for Purposefull life	Mr.Prathamesh Dhadse Ms. Pragati Wanjarkar	Lt.Dr.Prashant Ambekar
III	12.45 p.m to 1.45 p.m	Basics and Career Opportunities in Chemistry and Home Science	Dr.Mrs.Vaishali Meshram Mrs.M.M.Deshpande	
IV	2.00 p.m to - 2.30.p.m.	Departmental Visits:	Zoology: CZM, CZB	Dr.Mrs.K.M.Paturkar
			Physics : PME	Prof.Mrs.Seema Ubale
			Chemistry: CBZ,CBM,CZM	Dr.Mrs.V.P.Meshram
V	2.30 p.m. to 3.30 p.m.	Physical Education	Dr.Rahul Kalode	

Dr. Shraddha Deshpande
Convener

Prof. Pitambar Humane
IQAC Co-ordinator

Dr. Akhlesh Peshwe
Principal

CO ORDINATOR
INTERNAL QUALITY ASSURANCE CELL

Principal
Dharampath M.P. Deo Memorial
Science College, Mumbai



DHARAMPETH M. P. DEO MEMORIAL SCIENCE COLLEGE,
North Ambazari Road, Near Ambazari Lake, Nagpur- 440033

DATA VALIDATION & VERIFICATION (DVV)

Name of the Programme : Lecture on Intellectual Property Rights (IPR)
Date of the Programme : 18th August 2022
Name of Chief Guest if any : -
Name of Guest Speaker if any : LT-DR. P. W. Ambekar and Dr. Mrs. V. V. Rangari

Sr. No.	Name of the Participant	Mobile Number	E-mail Id	Signature
	Tagnuti Ganesh Fulkwar	8767911307	Tagnutifulkwar@gmail.com	
	Shilpa Nilesh Deshpande	9130091540	shilpadeshpande21004@gmail.com	
	Aditi Ramon Vaidya	9075714591	aditivaidya619@gmail.com	
	Sonal G. Choudhary	8856355003	sonalichoudhary19@gmail.com	
	Angali Meshram	4767905772	angalimeshrame02@gmail.com	
	Sanjana Tabhane	9699186571	tabhanesanjana@gmail.com	
	Reeya Rahul Mundale	9359878357	reeyamundale@gmail.com	
	Kalyani Pramkrushna Sindram	8561004459	manishakumte99@gmail.com	
	Khushi Kamalakar Rewade	9011291202	khushirewade@gmail.com	
	Shamwani Lalchand Umare	9284249534	shamwaniumare1912@gmail.com	

Signature of:

Programme In-charge

COORDINATOR
INTERNAL QUALITY ASSURANCE CELL
DHARAMPETH, M. P. DEO MEMORIAL &
SCIENCE COLLEGE, NAGPUR

Principal
Principal
Dharampeth M. P. Deo Memorial
Science College, Nagpur.



DHARAMPETH M. P. DEO MEMORIAL SCIENCE COLLEGE,
North Ambazari Road, Near Ambazari Lake, Nagpur- 440033

DATA VALIDATION & VERIFICATION (DVV)

Aniket Jaysram Bawankar	9767219301	aniket.Bawankar56@gmail.com	Bawankar
Tejus Rajesh Chelmevar	9604662119	tejus.chelmevar@gmail.com	Tejus
Rally. Kaikha. Nanjari	9326019213	kaikhananjari@gmail.com	Rally
Samiksha Anant Panchbudhe	9763075890	samikshapanchbudhe363@gmail.com	S.Panchbudhe
Nitika Bishabhadur Rai	7058638984	nitika1419@gmail.com	Nitika
Anjali Norendra Mate	8421035181	anjali.mate041@gmail.com	Anante
Shushika Rajesh Kokate	9637554918	kokate.shushika@gmail.com	Shushika
Shrushtee Jaysingh Rathod	9976026256	jaysinghr763@gmail.com	Shrushtee Rathod
Vaishnav Namdeo Tonge	8421657943	vaishnavtonge2004@gmail.com	Vaishnav
Rutika Ganakh Yadav	8446085943	yadavrutika634@gmail.com	Rutika
Yogita Ramesh Denge	7058437240	yogitadenge@gmail.com	Yogita

CO ORDINATOR
INTERNAL QUALITY ASSURANCE CELL
Dharampeth, M. P. Deo Memorial &
SCIENCE COLLEGE, NAGPUR

Signature of:

Programme In-charge

Principal
Principal

Dharampeth M.P. Deo Memorial
Science College, Nagpur.



DHARAMPETH M. P. DEO MEMORIAL SCIENCE COLLEGE,
North Ambazari Road, Near Ambazari Lake, Nagpur- 440033

DATA VALIDATION & VERIFICATION (DVV)

Monika I. Patel	7499225468	manikapatel7088@gmail.com	Manika
Ritika R. Bhojar	9834587087	ritikabhoyar28@gmail.com	Ritika
Shital O. Patle	9164596337	69985589@gmail.com	Shital
Ruchi Diwedi	8080776893	ruchidiwedi230@gmail.com	Ruchi
Karishma Prasad	9309318667	narendraprasad72@gmail.com	Karishma
Megha S. Ballav	9421728880	meghamballav@gmail.com	Megha
Kritika M. Deshmukh	9694720960	kritikam20@gmail.com	Kritika
Siddhi B. Tiwari	8084143696	siddhitiwari0721@gmail.com	Siddhi
Ankasha K. Khobragade	7972228707	ankashakhobragade@gmail.com	Ankasha
Gurjan Bhojar	7666799586	gurjanbhoyar@gmail.com	Gurjan
Ashiya Husain	9359259741	Ashiyahusain@gmail.com	Ashiya
Amisha Arkar	7666559171	amishakar@gmail.com	Amisha
Vaidhi P. Thete	755499191	vaidhitete21@gmail.com	Vaidhi
Ritika R. Sondliya	9175581555	ritikarsondliya@gmail.com	Ritika
Urmang. G. Warthi	9322428500	urmangwarthi@gmail.com	Urmang
Abhishek R Singh	8208948107	abhi0882005@gmail.com	Abhishek
Lucky A Vishwakarma	857966186	lvishwakarma@240gmail.com	Lucky

Signature of:

S. Adeshwari
Programme In-charge

[Signature]

COORDINATOR
INTERNAL QUALITY ASSURANCE CELL
DHARAMPETH M. P. DEO MEMORIAL &
SCIENCE COLLEGE, NAGPUR

[Signature]
Principal

Dharampeth M.P. Deo Memorial
Science College, Nagpur.



DHARAMPETH M. P. DEO MEMORIAL SCIENCE COLLEGE,
North Ambazari Road, Near Ambazari Lake, Nagpur- 440033

DATA VALIDATION & VERIFICATION (DVV)

Aakamsha Yogesh mairal	8010923662	aakuyogi2004@gmail.com	Ay mairal
Nisha Kosarkar	9890996645	nishakosarkar33@gmail.com	Nisha Kosarkar
Pranali Dehankar	8767581278	pdehna@gmail.com	Pranali P.D
Kastika Deshmukh	9699720960	Kastika.mde0@gmail.com	Kastika Deshmukh
Umang Warthi	9322428500	Umangwarthi@gmail.com	Umang Warthi
Khushi Pali	8767607224	PalikhushiPali@gmail.com	Khushi Pali
Mah. Shaware	9960629566	thauxwarahi7@gmail.com	Mah. Shaware
Ritika Sondhiya	9175581655	ritikasondhiya@gmail.com	Ritika
Siddhi Tiwari	8087143696	siddhitiwari0721@gmail.com	Siddhi Tiwari
Prachi Gaikwad	7385412959	Prachigaikwad2705@gmail.com	Prachi Gaikwad
Khushbu Pali	8459565214	palikhushbu@gmail.com	Khushbu Pali
Kashish Bisen	7887886117	kashishbisen@gmail.com	K. Bisen
Ishita Deshpande	9130091540	ishitandeshpande21004@gmail.com	Ishita
Simran Dhumele	7666230683	Simrandhumele80@gmail.com	Simran Dhumele
Sanchita Patil	7218079074	sanchitapatil2003@gmail.com	Sanchita Patil

Signature of:

Programme In-charge

CO ORDINATOR
INTERNAL QUALITY ASSURANCE CELL
DHARAMPETH, M. P. DEO MEMORIAL &
SCIENCE COLLEGE, NAGPUR

Principal
Dharampeth M.P. Deo Memorial
Science College, Nagpur.



DHARAMPETH M. P. DEO MEMORIAL SCIENCE COLLEGE,
North Ambazari Road, Near Ambazari Lake, Nagpur- 440033

DATA VALIDATION & VERIFICATION (DVV)

Komalika S. Chaudhari	9322033866	KomalikaChaudhari073@gmail.com	Komalika
Pranali R. Debnikar	8167581278	pdehna@gmail.com	Pranali R. D
Vaidhvee B. Gangul	7507907278	vaidhveegangul@gmail.com	Vaidhvee
Sakshi S. Hagone	9766322068	Sakshihagone2004@gmail.com	Sakshi
Simran N. Chimale	9284583851	mishralaxmi210@gmail.com	Chimale
Aaryushi V. Singh	7498985604	Singhpsati7408@gmail.com	Singh
Ruchi P. Dwivedi	8080776893	Ruchidwivedi2306@gmail.com	Ruchi
Khushbu Pali	8459565214	paliKhushbu59@gmail.com	Khushbu
Sakshi Chaudhary	8806002583	SakshiChaudhary126@gmail.com	Sakshi
Niketa Nimbalkar	8379980503	nikenimbalkar143@gmail.com	N
Medha Nimbalkar	9579674696	medhanimbalkar@gmail.com	Nimbalkar
Veena Borikar	9322016921	veenaborikar14@gmail.com	Veena
Utkarsha Ingale	7499159178	utkarshaingale9@gmail.com	Utkarsha
Vidya Lohi	7020963219	Vidyalohi8@gmail.com	V
Muskan Kulkarni	9156889239	MuskanKulkarni34@gmail.com	M
Gravsi R. Bhojare	8668335876	bhojaregravi754@gmail.com	Gravsi

Signature of:

S. D. D. Pande
Programme In-charge

[Signature]

IQAC Coordinator

...
DHARAMPETH, M. P. DEO MEMORIAL &
SCIENCE COLLEGE, NAGPUR

[Signature]
Principal

Dharampeth M.P. Deo Memorial
Science College, Nagpur.



DHARAMPETH M. P. DEO MEMORIAL SCIENCE COLLEGE,
North Ambazari Road, Near Ambazari Lake, Nagpur- 440033

DATA VALIDATION & VERIFICATION (DVV)

Name of the Programme : Lecture on TPCG, WomenCell, Magazine, Grievance Redressal,
Date of the Programme : Cultural, Extracurricular, Cell against Sexual Harassment
Name of Chief Guest if any : 18th August 2022
Name of Guest Speaker if any : Dr. M.N. Shradha Deshpande, Dr. Rajesh Pashine,
Dr. V.V. Rangari, Mrs. M.M. Deshpande.

Sr. No.	Name of the Participant	Mobile Number	E-mail Id	Signature
	Meenal Chaudhary	9529014604	meenalchaudhary2004@gmail.com	
	Pramali Chauhan	9699656562	pramalicauhan99@gmail.com	
	Riya Rajbhar	8800256951	riyaraajbhar18@gmail.com	
	Amisha Akkalla	7666559171	akastamisha700@gmail.com	
	Dhanashri M. Neware	9359909819	dhanashrineware186@gmail.com	
	Jhanvi Janki H. Laibey	8446510539	Jhanvilaibey@gmail.com	
	Sakshi S. Chaudhary	9706341962	Sakshichaudhary1933@gmail.com	
	Rally. K. Narjari	9326019213	Kelkharanarjari1234@gmail.com	
	Bhavana A. Gurusarani	8888937305	bhavanagurusarani@gmail.com	
	Aditi R. Vaidya	907574591	aditivaidya619@gmail.com	

Signature of:

Programme In-charge

COORDINATOR
INTERNAL QUALITY ASSURANCE CELL
DHARAMPETH, M. P. DEO MEMORIAL &
SCIENCE COLLEGE, NAGPUR

Principal
Dharampeth M.P. Deo Memorial
Science College, Nagpur.



DHARAMPETH M. P. DEO MEMORIAL SCIENCE COLLEGE,
North Ambazari Road, Near Ambazari Lake, Nagpur- 440033

DATA VALIDATION & VERIFICATION (DVV)

Vedant Anket Umetkar	9049932753	umetkar.vedant@gmail.com	<i>Vedant</i>
Tejas Ramesh Dongre	9322578918	Tejasdongre453@gmail.com	<i>Tejas</i>
Tushar Rupkumar Achare	9075995617	achare.tushar15@gmail.com	<i>Tushar</i>
Vineet .Mukesh. Singh	8552987293	SinghVineet78524@gmail.com	<i>Vineet</i>
Trushabh D. Saha	7385310571	Trushabh.saha2004@gmail.com	<i>Trushabh</i>
Manthan Mukesh Todase	7020663916	manthanTodase@gmail.com	<i>Manthan</i>
Pritam Surendra Kature	801093204	Pritamkature655@gmail.com	<i>Pritam</i>
Surej M. Mishra	9730639023	myanamishra973063@gmail.com	<i>Surej</i>
Atul D. Thakre	9881956597	atthakredevisingh@gmail.com	<i>Atul</i>
Lucky K. Navghate	9359626522	navghatelucky@gmail.com	<i>Lucky</i>
Sohail K. Mansuri	9322826557	Sohail.mansuri123@gmail.com	<i>Sohail</i>
Astha .P. Bhowray	9156003806	asthabhowray@gmail.com	<i>Astha</i>
Nikita . B. Des	9246297880	NikitaBDes@gmail.com	<i>N. Des</i>
Aparna .motaqi	7020649887	Aparnamotaqi123@gmail.com	<i>Aparna</i>
Khushi .Bharti	9604367894	2003khushibharti@gmail.com	<i>Khushi</i>
Khushi D. Bhasad	9518538358	khushiphasad31@gmail.com	<i>Khushi</i>
Siddhi .B. Jiwani	8087143696	siddhijiwani0721@gmail.com	<i>Siddhi</i>
Gunjan .I. Bhojor	7666799586	gunjanbhojor04@gmail.com	<i>Gunjan</i>

Signature of:

Satishpande
Programme In-charge

CO ORDINATOR
IOAC Coordinator
INTERNAL QUALITY ASSURANCE CELL
DHARAMPETH, M. P. DEO MEMORIAL &
SCIENCE COLLEGE, NAGPUR

Satishpande
Principal
Dharampeth M.P. Deo Memorial
Science College, Nagpur.



DHARAMPETH M. P. DEO MEMORIAL SCIENCE COLLEGE,
North Ambazari Road, Near Ambazari Lake, Nagpur- 440033

DATA VALIDATION & VERIFICATION (DVV)

Name			
Durgesh K. Ghodmare	9075318618	durgeshghodmare@gmail.com	
Uday C. Baghele	8459549609	bagheleuday@gmail.com	
Samyak M. Hadke	7020191304	samyakhadke30@gmail.com	
Ankit R. Patel	9970905638	ankitpatel79727@gmail.com	
Sandeep Kumar	8081144948	Sandeepk27900@gmail.com	
Ved. S. Choudhary	7498572766	vedchoudhary.cs.749@gmail.com	
Jeet S. Pardhi	7020215431	jeetspardhi111@gmail.com	
Saurabh Chaudhary	9359883501	Schaudhary5599@gmail.com	
Mohit M. Khirdekar	8055328357	mohitkhirdekar@gmail.com	
Yash K. Khadate	9112257306	yashkhadate@gmail.com	
Gouseav G. Fulke	7620646386	gouseavgarnoo@gmail.com	
Amay Borkar	9145401246	amayborkar42@gmail.com	
Anshul Yashraj Kirmapure	9284067169	anshulkirmapure650@gmail.com	
Shivam Umesh Patel	7038889083	Kshivam03skp@gmail.com	

Signature of:

Programme In-charge

CO ORDINATOR
INTERNAL QUALITY ASSURANCE CELL
DHARAMPETH, M. P. DEO MEMORIAL &
SCIENCE COLLEGE, NAGPUR

Principal
Dharampeth M.P. Deo Memorial
Science College



DHARAMPETH M. P. DEO MEMORIAL SCIENCE COLLEGE,
North Ambazari Road, Near Ambazari Lake, Nagpur- 440033

DATA VALIDATION & VERIFICATION (DVV)

Prachi J. Pardhi	7263935912	prachipardhi282@gmail.com	Pardhi Pardhi
Apeksha S. Katangale	7559455794	apekshakatangale26@gmail.com	Akatangale
Sunaina P. Chichonde	8530970132	Sunainachichonde123@gmail.com	Chichonde
Boja Sharan Kankale	7385554139	bojakankale28@gmail.com	Boja S. Kankale
Shwiti S. Channekar	9699823842	shwitichannekar706@gmail.com	Shwiti S. Channekar
Rutuja V. Bhure	9096030987	rutujabhure16@gmail.com	Rutuja V. Bhure
Kalash V. Gaichane	9322954663	kalashgaichane@gmail.com	Gaichane
Sejal K. Saneshwar	8010168912	sejalsaneshwar@gmail.com	Sejal K. Saneshwar
Ashwini R. Chaudhary	9699792732	chaudharyashwini287@gmail.com	A. R. Chaudhary
Ashalesha R. Khadgi	8830414264	AshaleshaKhadgi@gmail.com	Ashalesha R. Khadgi
Aditi S. Jogi	9579962108	aditi.jogi2002@gmail.com	Aditi S. Jogi
Megha S. Ballar	9421728880	meghaballar04@gmail.com	Megha S. Ballar
Jarhi A. Kinnapure	7058235243	jarhikinnapure@gmail.com	Jarhi A. Kinnapure
Kashish K. Bisen	7887886117	kashishbisen05@gmail.com	K. Bisen
Khushi P. Pali	8767607224	PaliKhushi4@gmail.com	Khushi P. Pali

CO ORDINATOR
INTERNAL QUALITY ASSURANCE CELL
DHARAMPETH, M. P. DEO MEMORIAL &
SCIENCE COLLEGE, NAGPUR

Principal
Dharampeth M.P. Deo Memorial
Science College, Nagpur.

Signature of:

Programme In-charge



DHARAMPETH M. P. DEO MEMORIAL SCIENCE COLLEGE,
North Ambazari Road, Near Ambazari Lake, Nagpur- 440033

DATA VALIDATION & VERIFICATION (DVV)

Chanchal. Kishor. Waghmare	7796016894	waghmarechanchal@gmail.com	Chanchal
Meenal Anurag Chaudhary	9529014604	meenalchaudhary2004@gmail.com	Meenal Chaudhary
Pranali Yashwant Chavhare	9699654562	pranalicavhare99@gmail.com	Pranali Chavhare
Prerit Bhaugura Sharma	8010764549	prerit1982004sharma@gmail.com	Prerit Sharma
Ghanashree Uddhar Dhokane	8459807047	ghanashreedhokane@gmail.com	Ghanashree Dhokane
Yachana Khamath Pandey	9156035297	yachanapandey@gmail.com	Yachana Pandey
pradnya Bandu Tirpude	8010362232	pradnyatirpude9145@gmail.com	Pradnya Tirpude
Dhanashree Mohapatra Newar	9359909913	Dhanashree@786@gmail.com	Dhanashree Newar
TANU. AJAY. SINGH	8806355808	tanusingh63499@gmail.com	Tanu Singh
ARJU SANJEEV RAI	8149194497	arju08@gmail.com	Arju Rai
Himanshi J. Kalbande	9665301444	kalbandehimanshi@gmail.com	Himanshi Kalbande
Sakshi A. Mishra	9158788969	smishra99683@gmail.com	S. Mishra
Janhvi. M. Joge	7385060871	Jogepratibha@gmail.com	Janhvi Joge
Sakshi. R. CHAKUNDE	7843018801	sakshichakunde@gmail.com	Sakshi Chakunde
Janhvi H. Laibex	844650539	Janvilaibex@gmail.com	Janhvi Laibex

COORDINATOR
INTERNAL QUALITY ASSURANCE CELL
DHARAMPETH, M. P. DEO MEMORIAL &
SCIENCE COLLEGE, NAGPUR

Principal
Dharampeth M.P. Deo Memorial
Science College, Nagpur.

Signature of:

Programme In-charge



DHARAMPETH M. P. DEO MEMORIAL SCIENCE COLLEGE,
North Ambazari Road, Near Ambazari Lake, Nagpur- 440033

DATA VALIDATION & VERIFICATION (DVV)

Name of the Programme : Deeksharambha 22-23 (Visit to Raman Science Center)
 Date of the Programme : 18th August 2022
 Name of Chief Guest if any : -
 Name of Guest Speaker if any : -

Sr. No.	Name of the Participant	Mobile Number	E-mail Id	Signature
✓ 1	Ashalesha Khadgi P	8830414264	Ashaleshakhadgi@gmail.com	Ashalesha.k
✓ 2	Suraina Chichonde P	8530970132	Surainachichonde@gmail.com	Suraina
✓ 3 ✓	Dhruvona Gureudasani P	8888437303	dhruvonagureudasani@gmail.com	Dhruvona
✓ 4 ✓	Anjali Narendra Mate P	8421035181	anjalinmate041@gmail.com	Anjali
✓ 5 ✓	Poojita Mangal Meshram P	8080796804	Pmeshram041@gmail.com	Poojita
✓ 6 ✓	Shikha Bhalpande P	9130091540	shikhandeshpande21004@gmail.com	Shikha
✓ 7 ✓	Aditi D. Vaidya P	9075714591	Adaditivaidya619@gmail.com	Aditi
✓ 8 ✓	Vaishnavi S. Torze P	8421657943	Vaishnavitorze2004@gmail.com	Vaishnavi
✓ 9 ✓	Shivam Umesh Patel P	7038889083	SP040263@gmail.com	Shivam
✓ 10 ✓	Utkarsha Ranjay Ingale P	7499159178	utkarshaingale9@gmail.com	Utkarsha

Signature of:

Programme In-charge

CO ORDINATOR
INTERNAL QUALITY ASSURANCE CELL
DHARAMPETH, M. P. DEO MEMORIAL &
SCIENCE COLLEGE, NAGPUR

Principal
Dharampeth M.P. Deo Memorial
Science College, Nagpur.



DHARAMPETH M. P. DEO MEMORIAL SCIENCE COLLEGE,
North Ambazari Road, Near Ambazari Lake, Nagpur- 440033

DATA VALIDATION & VERIFICATION (DVV)

1				
✓ 11	Trushabh Dipankar saha	87385310571	trushabhsaha2002@gmail.com	
✓ 12	Megha Shankar Ballav P	9421728880	meghaballav04@gmail.com	
✓ 13	Anvay Bhairaj Barkar P	914540246	anvaybarkar420@gmail.com	
✓ 14	Gunjan Ishwar Bhoyar P	7666799586	gunjanbhoyar01@gmail.com	
✓ 15	Sakshi. Anurag chaudhary	9766341969	Sakshichaudhary71389@gmail.com	
✓ 16	Apeksha Digambar Katangale	7559455794	apekshakatangale26@gmail.com	
✓ 17	Prachi Gaurushankar Pardhi	7263935912	prachipardhi282@gmail.com	
✓ 18	Komalika Sheshram chandhari	9322093866	Komalikachandhari073@gmail.com	
✓ 19	Krushbu Pali P	8489585214	palikrushbu57@gmail.com	
✓ 20	Krushu Pali P	8767607224	palikrushu4@gmail.com	
✓ 21	Kashish Bisen P	7887886117	Kashishbisen05@gmail.com	
✓ 22	Jantvi Kisnapur P	7058235243	Jantvikisnapur@gmail.com	
✓ 23	Nitu Rai P	7058638984	niturai1019@gmail.com	
✓ 24	Rutika Yadav P	8446089943	yadavrutika434@gmail.com	

Signature of:

Programme In-charge

CO ORDINATOR
INTERNAL QUALITY ASSURANCE CELL
DHARAMPETH, M. P. DEO MEMORIAL &
SCIENCE COLLEGE, NAGPUR

Principal
Principal
Dharampeth M.P. Deo Memo
Science College, Nagpur



DHARAMPETH M. P. DEO MEMORIAL SCIENCE COLLEGE,
North Ambazari Road, Near Ambazari Lake, Nagpur- 440033

DATA VALIDATION & VERIFICATION (DVV)

✓ 25	Meenal Chaudhary	f	9529014604	meenalchaudhary2004@gmail.com	Chaudhary
✓ 26	Ranali Chaudhary	f	9699654562	ranalichaudhary67@gmail.com	Chaudhary
✓ 27	Dhanashree Neware	f	9359909913	Dhanashreeneware1966@gmail.com	Neware
✓ 28	Khushi Rewade	f	9011291202	khushirewade@gmail.com	Rewade
✓ 29	Ved. S. Chaudhary	f	7498572766	vedchoudhary.cs.749@gmail.com	Red
✓ 30	Shamvati L. Umari	f	9284249534	shamvati.umari1912@gmail.com	Umari
✓ 31	Aakasha Yogesh mairal	f	8010923662	aakyaakuyogi@gmail.com	Aymairal
✓ 32	Tanu. AJAY. SINGH	f	8806955808	tanusingh168492@gmail.com	Tanu
✓ 33	Jankvi Mahadeo Joge	f	738506087	jogeprobha@gmail.com	Jankvi
✓ 34	SAKSHI RAJU CHAKUNDE	f	7843018801	sakshichakunde@gmail.com	Chakundes
✓ 35	Sanjana S. Tabhane	f	9699186571	tabhane.sanjana@gmail.com	Sanju
✓ 36	Gauri R. Bhojra	f	8668335876	bhojragauri954@gmail.com	Gauri
✓ 37	Aditi. S. Jogi	f	9579962108	aditi.jogi.2002@gmail.com	Aditi
✓ 38	Saurabh Chaudhary	f	9359883501	schaudhary5599@gmail.com	Chaudhary
✓ 39	Mohit Mahesh Khirdekar	f	8055328357	mohit.khirdekar@gmail.com	Maheshkar

Signature of:

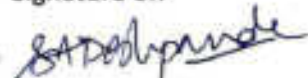
Programme In-charge

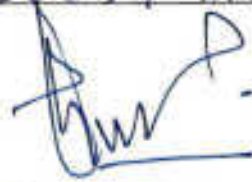

COORDINATOR
INTERNAL SECURITY & INSURANCE CELL
DHARAMPETH, M. P. DEO MEMORIAL &
SCIENCE COLLEGE, NAGPUR

Principal
Principal

Dharampeth M.P. Deo Memorial
Science College, Nagpur.



DHARAMPETH M. P. DEO MEMORIAL SCIENCE COLLEGE,
North Ambazari Road, Near Ambazari Lake, Nagpur- 440033

DATA VALIDATION & VERIFICATION (DVV)

✓	✓40	Vansha Lekhanam Turkari	P	9373650950	Vanshaturkari@gmail.com	Vansha
✓	41	Vineet. Mukesh Singh	P	8532987293	SinghVineet@gmail.com	Vineet
✓	42	Sandeep Kumar	P	8081149948	Sandeepk2790@gmail.com	Sandeep
✓	✓43	Ankit R. Patel	P	9970905638	ankitpatel797225@gmail.com	Ankit
✓	44	Sahel V. Mansuri	P	9322826557	SahelMansuri1112@gmail.com	Sahel
✓	45	Nisha .V. Pandey	P	9921689246	vicky25@gmail.com	Nisha
✓	46	Jeet S. Pardhi	P	7020215431	jeetspardhi11@gmail.com	Jeet
✓	47	Vibhanshu.K. Taine	P	9561232204	VibhanshuTaine7@gmail.com	Vibhanshu
✓	48	Tejas R. Dongre	P	9322578918	Tejasdongre45@gmail.com	Tejas
✓	49	Vedant Unathkar	P	9049932753	Unathkarvedant@gmail.com	Vedant
✓	50	Anshul Yuvraj Kisanpuro	P	9224067169	anshulkisanpuro650@gmail.com	Anshul

CO ORDINATOR
INTERNAL QUALITY ASSURANCE CELL
DHARAMPETH, M. P. DEO MEMORIAL &
SCIENCE COLLEGE, NAGPUR

Signature of:

Programme In-charge

Principal
Principal
Dharampeth M.P. Deo Memorial
Science College, Nagpur.



DHARAMPETH M. P. DEO MEMORIAL SCIENCE COLLEGE,
North Ambazari Road, Near Ambazari Lake, Nagpur- 440033

DATA VALIDATION & VERIFICATION (DVV)

Name of the Programme : Career Opportunities through MPSC/UPSC and in Statistics
Date of the Programme : 19th August 202
Name of Chief Guest if any : -
Name of Guest Speaker if any : Dr. Suresh Jadhav and Dr. Mrs. Jyoti Shivalkar

Sr. No.	Name of the Participant	Mobile Number	E-mail Id	Signature
1	Ashalesha Khadgi	8830414264	Ashalesha.khadgi@gmail.com	Ashalesha.K
2	Sumeeta chichonde	8530970132	Sumeeta.chichonde123@gmail.com	chichonde
3	shruti channekar	9699823842	shrutichannekar06@gmail.com	Shruti
4	Pooja Sharad Kankale	7385554139	poojakankale.28@gmail.com	Pooja S. Kankale
5	Khushi R. Pali	8767607224	pali.khushi4@gmail.com	Khushi
6	Khushbu Pali	8459565214	pali.khushbu59@gmail.com	Khushbu
7	Kashish Bisen	7887886117	kashishbisen05@gmail.com	K. Bisen
8	Mahima Khate	9545918678	Mahimakhate12@gmail.com	Mahima
9	Megha S. Ballav	9421728880	meghaballav04@gmail.com	Megha Ballav
10	Gunjan Jehwas Bhoyar	7666799586	gunjanbhoyar04@gmail.com	Gunjan

Signature of:

Programme In-charge

COORDINATOR
INTERNAL QUALITY ASSURANCE CELL
DHARAMPETH, M. P. DEO MEMORIAL &
SCIENCE COLLEGE, NAGPUR

Principal
Dharampeth M.P. Deo Memorial
Science College, Nagpur.



DHARAMPETH M. P. DEO MEMORIAL SCIENCE COLLEGE,
North Ambazari Road, Near Ambazari Lake, Nagpur- 440033

DATA VALIDATION & VERIFICATION (DVV)

1	TANU . AJAY . SINGH	8806355808	tanusingh163492@gmail.com	Tanu
2	Aakansha Yogesh mairal	8010923662	agkuygia@gmail.com	Aymairal
3	Shrawani Lalchand Umrekar	9284249534	shrawani.umrekar1912@gmail.com	Shrawani
4	Arju Sanjeev Rai	8149194497	arju08@gmail.com	Arju
5	Jagruti Fulkowar	8767911807	Jagrutifulkowar@gmail.com	Jagti
6	Mudrank Kulkarni	9156889239	Mudrankulkarni34@gmail.com	Mudrank
7	Pratiksha M. Meshram	8459070338	meshrampratiksha14@gmail.com	Pratiksha
8	Ishita . N. Deshpande	9130091540	ishitandeshpande21004@gmail.com	Ishita
9	Aditi . R . Vaidya	9075714591	aditivaidya619@gmail.com	Ad
10	Bhavana . A . Gureudasari	8888437303	bhavanagureudasari@gmail.com	Bhavana
11)	Vidhee . B . Gangal	9507907298	gangalvidhee@gmail.com	Vidhee
12)	Komalika . S . Chaudhari	9322033866	KomalikaChaudhari073@gmail.com	Komalika
13)	Pranali Vipin Gupta	7020069377	pg 991537@gmail.com	Pranali
14)	Nisha vidyabhushan Pandey	9921417084	vicky25@gmail.com	Nisha
15	Yachana Khornath Pandey	9156035297	pandeyyachana28@gmail.com	Pandey

[Handwritten Signature]

CO ORDINATOR

INTERNAL QUALITY ASSURANCE CELL
DHARAMPETH, M. P. DEO MEMORIAL &
SCIENCE COLLEGE, NAGPUR

[Handwritten Signature]
Principal
Principal

Dharampeth M.P. Deo Memorial
Science College, Nagpur.

Signature of:
[Handwritten Signature]
Programme In-charge



DHARAMPETH M. P. DEO MEMORIAL SCIENCE COLLEGE,
North Ambazari Road, Near Ambazari Lake, Nagpur- 440033

DATA VALIDATION & VERIFICATION (DVV)

Pritya Bhagywan Sharma	8010764549	pritya19012004sharma@gmail.com	Pritya
Pranali Jashwant Chaudhary	9699654562	pranalicchaudhary@gmail.com	Pranali
Veena Vilhas Borikar	9322016921	veenaborikar14@gmail.com	Veena
Janhvi A. Kismapure	7058235243	janhvikismapure@gmail.com	Janhvi
Astha P. Bhowray	9156003306	asthabhowray@gmail.com	Astha
Gauri R. Bhojari	8668335876	bhojari754@gmail.com	Gauri
Ashwini R. Chaudhary	9699792732	chaudharyashwini287@gmail.com	A.R. Chaudhary
Reeya Rahul Mundale	9359878357	reeyamundale@gmail.com	Reeya
Anjali Rajendra Thakre	7066554821	thakreanju381@gmail.com	Anjali
Janki Mahadeo Joge	7385060871	JogePratibha1@gmail.com	Janki
Sakshi Ajay Mishra	9158788964	Sakshimishra99683@gmail.com	S. Mishra
Janhvi H. Laibey	8446510539	Jhanvilaibey@gmail.com	Janhvi
Sakshi S. Hagona	9766322068	Sakshihagona2004@gmail.com	Sakshi
Dhanashree M. Neware	9359909913	dhanashreeneware@gmail.com	Dhanashree
Putika 'G' Yadav	8446085998	yadavputika934@gmail.com	Putika

[Handwritten Signature]

[Handwritten Signature]

Signature of:
[Handwritten Signature]
Programme In-charge

CO ORDINATOR
INTERNAL QUALITY ASSURANCE CELL
DHARAMPETH M. P. DEO MEMORIAL &
SCIENCE COLLEGE, NAGPUR

Principal
Dharampeth M.P. Deo Memorial
Science College, Nagpur.



DHARAMPETH M. P. DEO MEMORIAL SCIENCE COLLEGE,
North Ambazari Road, Near Ambazari Lake, Nagpur- 440033

DATA VALIDATION & VERIFICATION (DVV)

Nitu Birbadkar Rai	7058638984	knitu1419@gmail.com	
Varsha Lekharam Turkar	9373550950	varshaturkar488@gmail.com	
Somyak Madhukar Hadke	7020191304	somyakhadke30@gmail.com	
Manthan M. Todare	7020463916	manthanTodare@gmail.com	
Vineet Mukesh Singh	8552587293	vsinghvineet78524@gmail.com	
Saurabh Chaudhary	9359883501	schaudhary5599@gmail.com	
Pritam Kulkode	7499317229	pritamkulkode@gmail.com	
Jeet S. Pardhi	7020215437	jeetspardhi@gmail.com	
Anshul Yuvraj Kirnapure	9284067169	anshulkirnapure650@gmail.com	
Tejas Ramesh Dongre	9322578918	tejasdongre45@gmail.com	
Vedant Ankar Umethkar	9049932753	umethkarvedant@gmail.com	
Anvay Bhojraj Borkar	914540246	anvayborkar42@gmail.com	
Anvay P. Tembhare	8975363145	anvay230102@gmail.com	
Himanshi J. Kalbande	9665301444	kalbandehimanshi@gmail.com	
Simran N. Dhimale	7666330683	mishralaxmi210@gmail.com	

Signature of:

Programme In-charge

CO ORDINATOR
INTERNAL QUALITY ASSURANCE CELL
DHARAMPETH, M. P. DEO MEMORIAL &
SCIENCE COLLEGE, NAGPUR

Principal
Dharampeth M.P. Deo Memorial
Science College, Nagpur.



DHARAMPETH M. P. DEO MEMORIAL SCIENCE COLLEGE,
North Ambazari Road, Near Ambazari Lake, Nagpur- 440033

DATA VALIDATION & VERIFICATION (DVV)

Sandeep Kumar	8081144948	sandeepk27960@gmail.com	Sandeep
Aniket - Kumare	8262817299	aniketkumare@gmail.com	Aniket
Ved. S. Choudhary	7498572766	vedchoudhary.cs.749@gmail.com	Ved
Ankit R. Patel	9970905638	ankitpatel797275@gmail.com	Ankit
Mohit M. Khindekar	8055328357	mohitkhindekar@gmail.com	Mohit
Kshiti's Korve	9563362274	Kshiti's Korve@gmail.com	Kshiti
Sejal Kolhe	8483045985	Kolhesejal04@gmail.com	Sejal
Kiran ghughure	9823710569	ghughurekiran@gmail.com	Kiran
TANU. HJAY. SINGH	8806355808	tanusingh63492@gmail.com	Tanu
Veena Ulhas Borikar	9322016921	veenaborikar14@gmail.com	Veena
Samiksha Amrut Panchbudhe	9763075890	Samikshapanchbudhe363@gmail.com	S. Panchbudhe
Ukaasha Sanjay Ingale	7499159178	ukaashaingale9@gmail.com	Ukaasha
Megha Shrikar Ballav	9421728880	meghballav04@gmail.com	Megha
Janki A. Kisanpore	7058235243	jankikisanpore@gmail.com	Janki
Prachi G. Pardhi	7263935912	prachipardhi282@gmail.com	P. G. Par

Signature of:

Sandeepande

Programme In-charge

[Signature]

CO ORDINATOR
INTERNATIONAL ASSURANCE CELL
DHARAMPETH, M. P. DEO MEMORIAL &
SCIENCE COLLEGE, NAGPUR

[Signature]

Principal
Dharampeth M.P. Deo Memorial
Science College, Nagpur.



DHARAMPETH M. P. DEO MEMORIAL SCIENCE COLLEGE,
North Ambazari Road, Near Ambazari Lake, Nagpur- 440033

DATA VALIDATION & VERIFICATION (DVV)

Simran N. Dhimale	7666 33 0683	mishralaxmi210@gmail.com	Dhimale
Sakshi A. Mishra	9158788969	Smishra39683@gmail.com	S. Mishra
Janhvi H. Laibey	8446510539	JhanviLaibey@gmail.com	Janhvi
Rutika G. Yadav	8446085943	yadavrutika434@gmail.com	Rutika
Varsha L. Turkar	9373650950	varshaturkar488@gmail.com	Turkar

Signature of:

Programme In-charge

CO ORDINATOR
INTERNAL QUALITY ASSURANCE CELL
DHARAMPETH, M. P. DEO MEMORIAL &
SCIENCE COLLEGE, NAGPUR

Principal
Dharampeth M.P. Deo Memorial
Science College, Nagpur.



DHARAMPETH M. P. DEO MEMORIAL SCIENCE COLLEGE,
North Ambazari Road, Near Ambazari Lake, Nagpur- 440033

DATA VALIDATION & VERIFICATION (DVV)

Name of the Programme : Induction Program. (Orientation Programme)
Date of the Programme : 19th August 2022.
Name of ~~the~~ Guest if any : ADRR, Bhavesh Kumbhare, District sports Joint Director Shardaul Moharil.
Name of Guest Speaker if any : ADRR, Bhavesh Kumbhare.

Sr. No.	Name of the Participant	Mobile Number	E-mail Id	Signature
1]	Ananya R. Motghare	9219218955	ananya.motghare1802@gmail	Ananya
2]	Nupur M. Sharma	9822042259	nupursharma208@gmail	Nupur
3]	Gargi L. Hadge	7972076671	gargihadge@gmail.com	Gargi
4]	Poojwal. Bhojra	8010434634	poojwalb738@gmail.com	Poojwal
5]	Sania Midhat Lajo	8975726700	midhatania@gmail.com	Sania
6]	Dharmapuri Lal	9975037356	dharmapuri.lal@gmail.com	Dharmalal
7]	Vedant Bixy	8530655796	vedantbixy2005@gmail.com	Vedant
8]	Harsh Kodape	9604571672	harshkodape008@gmail.com	Harsh
9]	Vaishnavi V. Gadge	9022976449	gadgavaishnavi00@gmail	Vaishnavi
10]	SAHU SINGH	7258868502	sahisikh06@gmail.com	Sahu

Signature of:

Programme in-charge

COORDINATOR
INTERNAL QUALITY ASSURANCE CELL
DHARAMPETH, M. P. DEO MEMORIAL &
SCIENCE COLLEGE, NAGPUR

Principal
Dharampeth M.P. Deo Memorial
Science College, Nagpur.



DHARAMPETH M. P. DEO MEMORIAL SCIENCE COLLEGE,
North Ambazari Road, Near Ambazari Lake, Nagpur- 440033

DATA VALIDATION & VERIFICATION (DVV)

11	Ashwaha. K. Kholeagade	7072228707	ashwahakholeagade@gmail.com	Ashwaha
12	Nitu B. Rai	7058638984	nitub1419@gmail.com	Nitu
13	Vaishnavi N. Tonge	8421657443	Vaishnavitonge2004@gmail.com	Vaish
14	Komalika . S. Chaudhari	9322033866	Komalikachaudhari073@gmail.com	KChaudhari
15	Gausi R. Bhoysar	8668335876	gausiarbhoysar39@gmail.com	Gausi
16	Dhanashree Neware	9359909913	dhanashreeneware186@gmail.com	Dhanashree
17	Riya Rajbhar	8668619305	riyarajbhar18@gmail.com	Riya
18	Amisha .D. Aukarya	7666559171	Aukaryaamisha700@gmail.com	Amisha
19	Yogita R. Derge	7058437240	yogitaderge@gmail.com	Yogita
20	Yashara K. Pandey	9156035297	pandeykn54@gmail.com	Yashara
21	Priya Dubey	8669465362	dubeyrameshpriya@gmail.com	PriyaDubey
22	Kalyani R. Sindram	8561004489	manishakumt11@gmail.com	Kalyani
23	Ashalesha R. Khadgi	9096211235	Ashaleshakhadgi@gmail.com	Ashalesha K
24	Sunaina .p. Chichonde	8530970132	Sunainachichonde123@gmail.com	Chichonde
25	Ritika .R. Sondhiya	9175581655	ritikausondhiya@gmail.com	Ritika

Signature of:

Programme In-charge

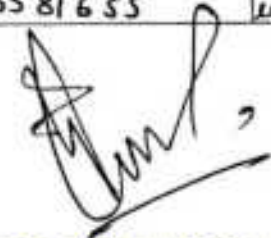
COORDINATOR
INTERNAL QUALITY ASSURANCE CELL
DHARAMPETH, M. P. DEO MEMORIAL &
SCIENCE COLLEGE, NAGPUR

Principal
Dharampeth M.P. Deo Memorial
Science College, Nagpur.



DHARAMPETH M. P. DEO MEMORIAL SCIENCE COLLEGE,
North Ambazari Road, Near Ambazari Lake, Nagpur- 440033

DATA VALIDATION & VERIFICATION (DVV)

26.	Aasiya Khatoun Sabih Hussain	9066411418	regiyahussain@sgy	Ahussain
27.	adidhi Bhagant Tiwari	8087143696	adidhitiwari072@gmail	adidhi
28.	Aufali Kishor Meshram	7767905772	aufalimeshram2003@gmail.com	Aufali
29.	Chanbal. K. Waghvani	7796016894	waghvanitara@gmail.com	chanbal
30.	Urnang Gangadhar Warthi	9322428500	Urnangwarthi@gmail.com	Urnang
31.	Harsha N. Vaidya	7588617445	harshavaidya1107@gmail.com	Haidya
32.	Asya Dhoke	9011681628	aynamasaka133@gmail.com	Asya
33.	Anjali .M. Singh	8317296731	anjalisinghas1524541@gmail.com.	Anjali
34.	Aakansha Y mairal	8020923662	aakanyogi2004@gmail.com	Aakansha
35.	Dally. K. Nanjari	9326013213	Krishnananjari12345@gmail.com	Dally
36.	Sharvani. L. Umaw	9284249534	sharvaniumaw1912@gmail.com	Sharvani
37.	Pranali .Y Chauhane	9699654567	pranalicchauhane69@gmail.com	Pranali
38.	Sanjana . S. Tabhane	9699186571	tabhane sanjan@gmail.com	Sanju
39.	Rishika Rajesh Kokate	9687554918	kokaterishika@gmail.com	Rishika
40.	Sakshi chaudhary	8766852462	Sakshi chaudhary 771933@gmail.com	Sakshi

Signature of:

Programme In-charge

CO ORDINATOR
INTERNAL QUALITY ASSURANCE CELL
DHARAMPETH, M. P. DEO MEMORIAL &
SCIENCE COLLEGE, NAGPUR

PRINCIPAL
Dharampeth M. P. Deo Memorial
Science College, Nagpur.



DATA VALIDATION & VERIFICATION (DVV)

41	Rashi Satpute	9145486983	rashisatpute77@gmail.com	And
42	Ghanashree U. Dheman	8459807047	ghanashreedheman@gmail.com	Response
43	Pooja B. Shekhar	8010764549	pooja19012004@gmail.com	Sharma
44	Anjali R. Thakre	9066554821	thakreanjuss1@gmail.com	Anjali
45	Shruti R. Chanekar	9699823842	shrutichanekar@gmail.com	Chanekar
46	Khushi S. Bhatti	9604367894	2003khushibhatti@gmail.com	Shi
47	Aparna G. Mohare	7020649887	AparnaMohare23@gmail.com	Ap. . (CBM)
48	Nikita S. Das	9604367892	nikitadas970@gmail.com	Nikita
49	Ravindra m. Khande	800198277	khandeconvindra@gmail.com	Khande (CBM)
50	Chiranjiv S. Gajbhiye	7196403357	cgajbhiye17@gmail.com	Gajbhiye (CZM)
51	Lucky A Vishwakarma	9579660186	lvishwakarma289@gmail.com	Vishwakarma
52	Anshul Yashraj Kshirsagar	9284067169	anshulkshirsagar650@gmail.com	Anshul
53	Jeet S. Pardhi	7020215431	jeetspardhi111@gmail.com	Pardhi
54	Anvay Borikar	9145401246	anvayborikar7420@gmail.com	Borikar
55	Manthan Manthan Todase	7020463916	manthan.todase@gmail.com	Todase

Signature of:

Programme In-charge

COORDINATOR
INTERNAL QUALITY ASSURANCE CELL
DHARAMPETH, M. P. DEO MEMORIAL &
SCIENCE COLLEGE, NAGPUR

Principal
Dharampeth M.P. Deo Memorial
Science College, Nagpur.



DHARAMPETH M. P. DEO MEMORIAL SCIENCE COLLEGE,
North Ambazari Road, Near Ambazari Lake, Nagpur- 440033

DATA VALIDATION & VERIFICATION (DVV)

56.	Somyak Hadke	7020171304	somyakhadke30@gmail.com
57.	Khushi K. Rewade	9588445994	khushirewade@gmail.com Rewade
58.	TANU .AJAY .SINGH	8806855808	tanusingh68499@gmail.com Tanu
59.	Mahima Khate	9545918678	mahimakhate11@gmail.com Khate
60.	Avishkar A. Bansod	7820841788	avishkarbansod02@gmail.com A.A.Bansod
61.	Harshad Wankhede	7414993575	harshadwankhede992@gmail.com Harshad
62.	Ashlesha Sangole	9503998469	Ashleshasangole94@gmail.com Sangole
63.	Nikita Pralapatkar	7058625053	nikitapralapatkar@gmail.com Pralapatkar
64.	Simran Bhimale	7666330683	simrandhimale80@gmail.com Bhimale

Signature of:

Programme In-charge

CO ORDINATOR
INTERNAL QUALITY ASSURANCE CELL
DHARAMPETH M. P. DEO MEMORIAL &
SCIENCE COLLEGE, NAGPUR

Principal
Dharampeth M.P. Deo Memorial
Science College, Nagpur.



DHARAMPETH M. P. DEO MEMORIAL SCIENCE COLLEGE,
North Ambazari Road, Near Ambazari Lake, Nagpur- 440033

DATA VALIDATION & VERIFICATION (DVV)

Name of the Programme

: Importance of Organ Donation

Date of the Programme

: 20th August 2022

Name of Chief Guest if any

: -

Name of Guest Speaker if any

: Dr. Ravi Wankhede (Mohan Foundation)

Sr. No.	Name of the Participant	Mobile Number	E-mail Id	Signature
1)	Jagruati Fulkawar	876794807	Jagruatifulkawar@gmail.com	
2)	Vaidhree B. Gangul	750207278	gangulvaidhree@gmail.com	
3)	Pranali R. Dehanekar	8767581278	PranaliR10@gmail.com	
4)	Anjali R. Thakre	7066554821	thakreanjur@gmail.com	Anjali
5)	Anjali M. Singh	8317296731	Anjalisinghas541546.com	Anjalisingh
6)	Khushi K. Rewade	9588445994	khushirewade@gmail.com	Krewade
7)	Shruvanshi L. Munawar	9284249534	shruvanshimunawar1912@gmail.com	Shruvanshi
8)	Aakansha Yashraj Mairal	9020923662	aakyogii@gmail.com	Aakansha
9)	Anjali Mishram	7767905772	anjalinimeshrm2022@gmail.com	Anjali
10)	Nishi B. Rai	7058638984	nishi1419@gmail.com	Nishi

Signature of:

Programme In-charge

CO ORDINATOR
INTERNAL QUALITY ASSURANCE CELL
DHARAMPETH, M. P. DEO MEMORIAL &
SCIENCE COLLEGE, NAGPUR

Principal
Dharampeth M.P. Deo Memorial
Science College, Nagpur.



DHARAMPETH M. P. DEO MEMORIAL SCIENCE COLLEGE,
North Ambazari Road, Near Ambazari Lake, Nagpur- 440033

DATA VALIDATION & VERIFICATION (DVV)

11)	Sonali Chaudhari	8856055003	sonalichaudhari19@gmail.com	Sonali
12)	Pranali Chaudhary	9699652562	pranali.chaudhary.es@gmail.com	Pranali
	Dhanashree Neware	9359909913	dhanashrineware22@gmail.com	Dhanashree
14)	Neeraj Chaudhary	9529014604	neerajchaudhary2004@gmail.com	Neeraj
15)	Apresha S. Ketangale	7559455794	apreshaketangale26@gmail.com	Apresha
16)	Komalika S. Chaudhary	9322033866	KomalikaChaudhary073@gmail.com	Komalika
17)	Sanjana S. Tabhare	9699186571	tabharsanjana@gmail.com	Sanjana
18)	Aditi R. Vaidya	9075714591	aditivaidya213@gmail.com	Aditi
19)	Geeta R. Bhoyas	8668335876	bhoyasgeeta754@gmail.com	Geeta
20)	Shrushtee T. Rathod	7776026256	jayasinghr673@gmail.com	Shrushtee Rathod
21)	Chanchal K. Waghware	7796016894	waghwanitara@gmail.com	Chanchal
22)	Sakshi S. Chaudhary	9166341962	SakshiChaudhary423@gmail.com	Sakshi
	Priya Prayana Shinde	8010764549	priya19012004shinde@gmail.com	Priya
	Yashna Khomrath Pandey	9156035297	pandeykn54@gmail.com	Pandey
	Nisha Vijabhavan Pandey	9921417084	vicky25@gmail.com	Nisha

Signature of:

SADASH PANDAY
Programme In-charge

[Signature]

CO ORDINATOR
INTERNAL QUALITY ASSURANCE CELL
DHARAMPETH, M. P. DEO MEMORIAL &
SCIENCE COLLEGE, NAGPUR

[Signature]
Principal

Dharampeth M.P. Deo Memorial
Science College, Nagpur.



DHARAMPETH M. P. DEO MEMORIAL SCIENCE COLLEGE,
North Ambazari Road, Near Ambazari Lake, Nagpur- 440033

DATA VALIDATION & VERIFICATION (DVV)

Shruti Channekar	9699223892	shrutichannekarpc@gmail.com	Shruti Channekar
Himanshi J. Kalbande	9665301444	Kalbandehimanshi@gmail.com	Himanshi Kalbande
Anshul Yuvraj Kinnarpure	9284067169	anshulkinnarpure650@gmail.com	Anshul
Abhay P. Tembhore	8975363145	abhay230102@gmail.com	Abhay
Pray B. Borkar	914540246	prayborkar42@gmail.com	Pray
Jeet S. Pardhi	7020215431	jeetspardhill@gmail.com	Jeet
Kshiti K. Korse	9503362270	kshitikorse@gmail.com	Kshiti
Sanyak madhukar Hadke	7020171304	Sanyakhadke80@gmail.com	Sanyak
Arya Dhoke	9011681628	aryanamrata1331@gmail.com	Arya
Reeya Rakul Mundale	9359878357	reeyamundale@gmail.com	Reeya
Ananya Ajit Jha	8983236002	ananyajha.0303@gmail.com	Ananya
Riyaz Anil Singh	9595649832	riyaz2307@gmail.com	Riyaz Singh
Ved S Choudhary	7498572766	vedchoudhary.cs.749@gmail.com	Ved
Sandeep Kumar	8081144948	sandeepk27900@gmail.com	Sandeep
Ankit R. Patel	9970905638	ankitpatel797275@gmail.com	Ankit Patel

Signature of:
Sandeep
Programme In-charge

CO ORDINATOR
INTERNAL QUALITY ASSURANCE CELL
DHARAMPETH, M. P. DEO MEMORIAL &
SCIENCE COLLEGE, NAGPUR

Principal
Principal
Dharampeth M.P. Deo Memorial
Science College, Nagpur.



DHARAMPETH M. P. DEO MEMORIAL SCIENCE COLLEGE,
North Ambazari Road, Near Ambazari Lake, Nagpur-440033

DATA VALIDATION & VERIFICATION (DVV)

	Tyushabh Saha	7385310571	tyushabhsaha2004@gmail.com	
	Meenal Choukhary	9529014604	meenalchoukhary2004@gmail.com	
	Ishita . N. Deshpande	9130091540	ishitandeshpande21004@gmail.com	

Signature of:

Ishita N. Deshpande
Programme In-charge

CO ORDINATOR
INTERNAL QUALITY ASSURANCE CELL
DHARAMPETH, M. P. DEO MEMORIAL &
SCIENCE COLLEGE, NAGPUR

Principal
Dharampeth M.P. Deo Memorial
Science College, Nagpur.



DHARAMPETH M. P. DEO MEMORIAL SCIENCE COLLEGE,
North Ambazari Road, Near Ambazari Lake, Nagpur- 440033

DATA VALIDATION & VERIFICATION (DVV)

Name of the Programme : Financial Literacy and Financial Planning
Date of the Programme : 22/08/2022
Name of Chief Guest if any : -
Name of Guest Speaker if any : Ms. Shivani Dani

Sr. No.	Name of the Participant	Mobile Number	E-mail Id	Signature
1	Chiranjiv. S. Gajbhaye	7796403357	cgajbhaye17@gmail.com	
2	Sahil. I. Khan	9322663997	SK2332096@gmail.com	
3	Vaishali M. Sahu	7972925603	vaishali.sahu291@gmail.com	
4	Khineshwarri R. Pishptode	8624976072	khineshwarripishptode@gmail.com	
5	Divyanshi G. Zade	7972403069	divyanizade2005@gmail.com	
6	Gendhal B. Machade	9112142728	nikhilmachade2005@gmail.com	
7	Trushabh D. Saha	7385310571	trushabhsaha2004@gmail.com	
8	Mohit U. Khadkekar	8055328357	mohit.khadkekar@gmail.com	
9	Seiyansh Sheel	9322148375	Seiyansh.sheel@gmail.com	
10	Shreya Bhimte	779624241	shreya.bhimte@gmail.com	

Signature of:

Programme In-charge

COORDINATOR
INTERNAL QUALITY ASSURANCE CELL
DHARAMPETH, M. P. DEO MEMORIAL &
SCIENCE COLLEGE, NAGPUR

Principal
Dharampeth M.P. Deo Memorial
Science College, Nagpur.



DHARAMPETH M. P. DEO MEMORIAL SCIENCE COLLEGE,
North Ambazari Road, Near Ambazari Lake, Nagpur- 440033

DATA VALIDATION & VERIFICATION (DVV)

11)	Sumanra Prem Chichonde	8530970132	sumanra.chichonde123@gmail.com	Chichonde
12)	Harshata G. Warkhede	8263977208	harshatawarkhede@gmail.com	Harshata
13)	Suhani P. Kohre	7776895303	suhani.kohre@gmail.com	
14)	Jagriti Fulkar	8767911807	jagritifulkar@gmail.com	JF
15)	Priyansu Nimbalkar	8379980503	nkani.mbalcar14@gmail.com	
16)	Muskan Kulkarni	9156889239	meerkankulkarni36@gmail.com	MSK
17)	Jeet S. Pardhi	2020215431	jeetspardhi111@gmail.com	
18)	Radant D. Umethkar	9049932753	umethkarradant@gmail.com	Radant
19)	Tejas F. Dongre	9322578918	Tejasdongre453@gmail.com	Tejas
20)	Lecika A. Vishwakarma			
21)	Mihel V. Meshram	8767792960	mihelmeshram@gmail.com	Mihel
22)	Anugrah M. Adkane	7410575982	anugrahadkane122@gmail.com	Anugrah
23)	Nayan N. Waltham	7848870941	nayanwaltham@gmail.com	Nayan
24)	Anshul Varun Kinsarpure	9224067169	anshulkinsarpure650@gmail.com	Anshul
25)	Ankita Patel	9970905638	ankitpatel797275@gmail.com	Ankita

Signature of:

Programme In-charge

CO-ordinator
INTERNAL QUALITY ASSURANCE CELL
DHARAMPETH, M. P. DEO MEMORIAL &
SCIENCE COLLEGE, NAGPUR

Principal
Dharampeth M.P. Deo Memorial
Science College, Nagpur.



DHARAMPETH M. P. DEO MEMORIAL SCIENCE COLLEGE,
North Ambazari Road, Near Ambazari Lake, Nagpur- 440033

DATA VALIDATION & VERIFICATION (DVV)

26)	Neha Lalchand Khanjari	9373832266	nehaxanjar133@gmail.com	Neha
27)	Pooja Sharad Kankale	7385554139	poojakankale28@gmail.com	Pooja Sharad
28)	Shruti Channekar	9699823842	shrutichannekar20@gmail.com	Shruti Channekar
29)	Ruchi Dewivedi	8080776893	Ruchidewivedi230@gmail.com	Ruchi
30)	Aayushi V. Singh	7498985604	Singhpriiti7496@gmail.com	Singh
31)	Nisha Sharad Kankale	9890996645	Nishakankale333@gmail.com	Nisha
32)	Anshikha Uskuda Jarawarkar	9021391207	anshikhajawarkar@gmail.com	Anshikha
33)	Poochi Krunishna Gajbhayo	9763768326	poochi.krunishna@gmail.com	Poochi
34)	Pranali R. Dehankar	2167581288	Pdehna@gmail.com	Pranali R. D
35)	Ishita N. Deshpande	9130091540	ishitandeshpande21004@gmail.com	Ishita
36)	Sakshi A. Mishra	9158788969	Smishra39683@gmail.com	Smishra
37)	Sakshi S. Chaudhary	9766341962	Sakshichaudhary27355@gmail.com	Sakshi
38)	Janki M. Toge	7385060171	JankiToge08@gmail.com	Janki
39)	Mrunali D. Bhatkar	9322727616	mrunalibhatkar@gmail.com	Mrunali
40)	Isha I. Waghmare	8855919474	Ishawaghmare9774@gmail.com	Isha

Signature of:

A. Deshpande
Programme In-charge

CO-ORDINATOR
INTERIM QUALITY ASSURANCE CELL
DHARAMPETH, M. P. DEO MEMORIAL &
SCIENCE COLLEGE, NAGPUR

Principal
Dharampeth M.P. Deo Memorial
Science College, Nagpur.



DHARAMPETH M. P. DEO MEMORIAL SCIENCE COLLEGE,
North Ambazari Road, Near Ambazari Lake, Nagpur- 440033

DATA VALIDATION & VERIFICATION (DVV)

41)	Saurabh Chaudhary	9359883501	schaudhary5599@gmail.com	Saurabh
42)	Shivam Patel	7038889083	sp040263@gmail.com	Shivam
43)	Pramo Jagdish Chaudhari	7620384149	jagdishchaudhari07@gmail.com	Chaudhari
44)	Veena Uhas Berikar	9322016921	veenaberikar14@gmail.com	Veena
45)	Samiksha Arant Paribudhe	9763075890	samikshapanchbudhe36@gmail.com	S. Paribudhe
46)	Chetna Satish Bawale	9145185124	chetna@2969mail.com	Chetna
47)	Udhar G. Gangal	9509907298	gangaludhar@gmail.com	Udhar
48)	Anjali Rajendra Thakre	7066554821	thakreanju381@gmail.com	Anjali
49)	Vaishnavi Manikrao Mashukhetri	8010256376	vaishnavimashukhetri@gmail.com	Vaishnavi
50)	Krutika Subhash Pakale	9021533341	pokalekrutika6@gmail.com	K. Pakale
51)	Rutika G. Yadav	8446085943	yadavrutika434@gmail.com	Rutika
52)	Astha P. Bhowrey	9156003306	asthabhowrey2002@gmail.com	Astha
53)	Bhagupsheli D. Neware.	7796434177	sakshineware@gmail.com	B.P. Neware
54)	Beenal V. Gupta	7020069377	vg_991537@gmail.com	Beenal
55)	Prachi G. Pardhi	7263935912	prachipardhi282@gmail.com	P. G. Pardhi

Signature of:

Programme In-charge



COORDINATOR

INTERNAL QUALITY ASSURANCE CELL
DHARAMPETH, M. P. DEO MEMORIAL &
SCIENCE COLLEGE, NAGPUR



Principal
Dharampeth M.P. Deo Memorial
Science College, Nagpur



DATA VALIDATION & VERIFICATION (DVV)

56)	Utkarsha .S. Ingale	7499159178	utkarshaingale30@gmail.com	Utkarsha
57)	Megha B. Shelkar	9421728880	megha.bshelkar24@gmail.com	Megha
58)	Tejas A. Kharapure	7258235243	tejas.kharapure@gmail.com	Tejas
59)	Muskan C. Verdyar	9909713287	muskanverdyar@gmail.com	Muskan
60)	Beevisha G. Besev	9579836218	beevisha.besev@gmail.com	Beevisha
61)	Shresha L. Turkar	8373650352	shresha.l.turkar@gmail.com	Shresha
62)	Ghanashree U. Dhamane	8459807047	ghanashreedhamane@gmail.com	Ghanashree
63)	Tejya Bhagwan Shewane	8010764549	tejya12012004@gmail.com	Tejya
64)	Yachana Khamnath Pandey	9156035297	pandeykns4@gmail.com	Yachana
65)	Krutika Subhash Pokale	9021533341	pokalekrutika6@gmail.com	Krutika
66)	Shruti .S. Chanekar	9699823842	shrutichanekar706@gmail.com	Shruti
67)	Sunaina P. Chichanale	8530970132	sunainachichanale1216@gmail.com	Sunaina
68)	Gunjan Ishwar Bhojar	7666799586	gunjanbhoyar04@gmail.com	Gunjan
69)	Sonal G. Choudhary	8856055003	sonalichoudhary19@gmail.com	Sonal
70)	Sanjana .S. Tabhane	9699186571	tabhanesanjana@gmail.com	Sanjana

Signature of:

Programme In-charge

CO ORDINATOR
INTERNATIONAL QUALITY ASSURANCE CELL
DHARAMPETH M. P. DEO MEMORIAL &
SCIENCE COLLEGE, NAGPUR

Principal
Dharampeth M.P. Deo Memorial
Science College, Nagpur.



DHARAMPETH M. P. DEO MEMORIAL SCIENCE COLLEGE,
North Ambazari Road, Near Ambazari Lake, Nagpur- 440033

DATA VALIDATION & VERIFICATION (DVV)

71)	Sandeep Rakesh Kumar	808114940	Sandeepk27900@gmail.com
72)	Ved. S. Chaudhary	7498572766	vedchaudharyss.749@gmail.com
73)	Aniket . Kumar	8262817299	avck@kumar@gmail.com
74)	Simran N. Dhimale	7666330683	mishralaxmi210@gmail.com
75)	Siddhi B. Tiwari	8087143696	siddhitiwari0721@gmail.com
76)	Rishika R. Kokate	9637554918	rishikatokate@gmail.com
77)	Lucky A Vishwakarma	9579660186	lvishwakarma239@gmail.com
78)	Manthan .M. Todase	7020463916	manthanTodase@gmail.com
79)	Reeya Rahul Mundale	9359878357	reeyamundale@gmail.com
80)	Kalyani Ramkrishna sindran	9500446159	manisha kumte11@gmail.com
81)	Chanchal .K. Waghware	7796016894	waghwaremitara@gmail.com
82)	Anjali Meshram	7767905772	anjali meshram2023@gmail.com
83)	Khushi .K. Rewade	9588445994	khushirewade@gmail.com
84)	Anjali .M. Singh	8317296731	anjalisinghas152454@gmail.com
85)	Aakansha Mairal	8010923662	aakanyogi2004@gmail.com

Signature of:

Programme In-charge



CO-ORDINATOR
INTERNAL QUALITY ASSURANCE CELL
DHARAMPETH, M. P. DEO MEMORIAL &
SCIENCE COLLEGE, NAGPUR

Principal

Dharampeth M.P. Deo Memorial
Science College, Nagpur.



DHARAMPETH M. P. DEO MEMORIAL SCIENCE COLLEGE,
North Ambazari Road, Near Ambazari Lake, Nagpur- 440033

DATA VALIDATION & VERIFICATION (DVV)

Name of the Programme : Induction Programme (2022-2023)
Date of the Programme : 22nd Aug 22 IST spoken, Bioinformatics, Mushroom cultivation
Name of Chief Guest if any : -
Name of Guest Speaker if any : Dr. Mrs. Snehal Narale, Dr. P. T. Humane

Sr. No.	Name of the Participant	Mobile Number	E-mail Id	Signature
1	Ashlesha Khadgi	8830414264	Ashleshakhadgi@gmail.com	Ashlesha.K
2	Sunaina Chichonde	8530970132	Sunainachichonde13@gmail.com	Chichonde
3	Bhavona Gwendasani	8888437303	bhavonagwendasani@gmail.com	Bhavona
4	Vaishnavi N. Tonje	8421657443	Vaishnavi2004@gmail.com	(Tonje)
5	Anjali N. Mate	8421035181	anjulimate04@gmail.com	Mate
6	Pratiksha M Meshram	8080796804	meshrampratiksha@gmail.com	Pratiksha
7	Chhita Deshpande	9130091540	chhitadeshpande21004@gmail.com	Chhita
8	Aditi Vaidya	9075714591	Aditi.vaidya.619@gmail.com	Ad
9	Veena Borikar	9322016921	veenaborikar14@gmail.com	Veena
10	Medha Nimbalkar	9579674696	medhanimbalkar@gmail.com	Nimbalkar

Signature of:

Programme In-charge

COORDINATOR
INTERNAL QUALITY ASSURANCE CELL
DHARAMPETH, M. P. DEO MEMORIAL &
SCIENCE COLLEGE, NAGPUR

Principal
Dharampeth M.P. Deo Memorial
Science College, Nagpur.



DHARAMPETH M. P. DEO MEMORIAL SCIENCE COLLEGE,
North Ambazari Road, Near Ambazari Lake, Nagpur- 440033

DATA VALIDATION & VERIFICATION (DVV)

Utkatsha Sanjay Ingale	7499159178	utkatshaingale9@gmail.com	
Nisha Vickyabhusan Pandey	9921683246	vicky25@gmail.com	
Muskan Chandrabhawan Veidya	9309773287	muskanveidya9@gmail.com	
Pratiksha Utkanishyam Bawe	9579836819	pratikshabawe49@gmail.com	
Nikhil Ramsingh Kurne	8999040961	kurne.nikhil@gmail.com	
Tanvi Mahadeo Joje	7385060871	Jojepratibha1@gmail.com	
Satshi Suresh Chaudhary	9766341962	SatshiChaudhary793@gmail.com	
Mansal Anand Chaudhary	5529014604	mansalchaudhary2004@gmail.com	
Dhanashree Mokopal neware	9359909913	dhanashree.neware766@gmail.com	
Saurabh Chaudhary	9359885501	Schaudhary5599@gmail.com	
Pranali Chaudhary	96596571582	pranalicchaudhary69@gmail.com	
Trushabh Dipankar saha	7385310571	trushabh.saha.2006@gmail.com	
Anay Bhagraj Borkar	9145401246	anayborkar420@gmail.com	
Ved. S. Chaudhary.	7498572766	vedchaudhary.cs.769@gmail.com	

COORDINATOR
INTERNATIONAL ASSURANCE CELL
DHARAMPETH, M. P. DEO MEMORIAL &
SCIENCE COLLEGE, NAGPUR

Principal
Principal

Dharampeth M.P. Deo Memorial
Science College, Nagpur.

Signature of:

Programme In-charge



DHARAMPETH M. P. DEO MEMORIAL SCIENCE COLLEGE,
North Ambazari Road, Near Ambazari Lake, Nagpur- 440033

DATA VALIDATION & VERIFICATION (DVV)

Shivam Unesh Late		sp040263@gmail.com	Shivam
Sohel K. mansuri	9322826557	Sohail mansuri112@gmail.com	Sohail
Vibhorbh. K. Tainr	9561232204	Vibhorbh.Tainr@gmail.com	Vibhorbh
Jeet C. Parzelli	7020215431	jeetspardhill@gmail.com	Jeet
Tajus R. Dongre	9322579918	Tajusdongre@5@gmail.com	Tajus
Vedant Uneshkar	9049932753	UneshkarVedant@gmail.com	Vedant
Anshul Yuvraj Kinapur	9284067169	anshulKinapur@gmail.com	Anshul
Sanjana Tabhane	9699186571	tabhanesanjana@gmail.com	Sanju
Gurjan Ishwar Bhoyar	7666799586	gurjanbhoyar04@gmail.com	Gurjan
Krushikali	8767607224	pratikkrushika@gmail.com	Krushika
Kashish Bisen	7887886117	Kashishbisen08@gmail.com	K. Bisen
Vineet Singh	5552987293	SinghVineet78524@gmail.com	Vineet
Krushikali Fali	98459565214	pratikkrushika59@gmail.com	Krushika
Aditi Jogi	9579962108	aditi.jogi2002@gmail.com	Aditi
Jarhi Kinapur	7058285243	jarhikinapur06@gmail.com	Kinapur

Signature of:

Programme In-charge

CO ORDINATOR
INTERNAL QUALITY ASSURANCE CELL
DHARAMPETH, M. P. DEO MEMORIAL &
SCIENCE COLLEGE, NAGPUR

Principal
Principal

Dharampeth M.P. Deo Memorial
Science College, Nagpur.



DHARAMPETH M. P. DEO MEMORIAL SCIENCE COLLEGE,
North Ambazari Road, Near Ambazari Lake, Nagpur- 440033

DATA VALIDATION & VERIFICATION (DVV)

Tirushahli sika	7385310571	tirushahli@ymail.com	Tirushahli
Ankit R. Patel	9970905638	ankitpatel79227@gmail.com	Ankit
Sandeep Kumar	8081144948	Sandeepk27900@gmail.com	Sandeep
Khushi Rewade	9588445994	khushirewade@gmail.com	Khushi
Aakansha mairal	8010923662	aakanyogi@gmail.com	Aakansha
Megha S. Ballav	9421728880	meghaballav04@gmail.com	Megha
Shamirani L. Illmou	4284249534	shamiranillmou@gmail.com	Shamirani
TANU . AJAY . SINGH	8806355808	tanusingh16349@gmail.com	Tanu
Mohit Mardkar	8055328357	mohit Mardkar@gmail.com	Mardkar
Gauri Ramesh Bhoyar	8668335876	bhoyargauri754@gmail.com	Gauri
Komalika .D. chaudhari	1322033866	KomalikaChaudhari073@gmail.com	Komalika
Apeksha D. Kotangale	7559455794	apekshakotangale26@gmail.com	Akotangale
Prachi G. Pardhi	7263935912	prachipardhi212@gmail.com	Pardhi
Vansha L. Turkar	9373650950	vanshaturkar488@gmail.com	Turkar

Signature of:

Programme In-charge

CO ORDINATOR
INTERNAL QUALITY ASSURANCE CELL
DHARAMPETH, M. P. DEO MEMORIAL &
SCIENCE COLLEGE, NAGPUR

Principal
Principal
Dharampeth M.P. Deo Memorial
Science College, Nagpur.



DHARAMPETH M. P. DEO MEMORIAL SCIENCE COLLEGE,
North Ambazari Road, Near Ambazari Lake, Nagpur- 440033

DATA VALIDATION & VERIFICATION (DVV)

	Nishi Rai	7058638984	nishi1419@gmail.com	
	Rutika Yadav	8646085963	yadavrutika934@gmail.com	

Signature of:

Programme In-charge

CO ORDINATOR
INTERNAL QUALITY ASSURANCE CELL
DHARAMPETH, M. P. DEO MEMORIAL &
SCIENCE COLLEGE, NAGPUR

Principal
Dharampeth M.P. Deo Memorial
Science College, Nagpur.



DHARAMPETH M.P. DEO MEMORIAL SCIENCE COLLEGE, NAGPUR
ROTARACT CLUB OF DMPDSVM
Activity Report

Date: 30/08/2022

Name of Organizing Department or Committee: Rotaract Club

Name of the activity: Orientation Program

Suggested CRITERION point if any: Criterion III & Criterion V

Date of Activity: 20-Aug-22

Place of Activity: Vinayakrao Phatak Hall

Name of Guest Speaker/s or Judge/s or Chief Guest/s if any: ADRR Bhavesh and IPP Shardul Moharil

Title of the Activity: Orientation Program

Number of Participants: 64

Name of the Teacher In-charge/Convener: Dr. Mrs. Shraddha Deshpande

Names of other Committee Members/ Staff: Rotaract Club Members

OUTCOME of the Activity with respect to mission vision of the institute and or academics:

The members and newly formed Rotaract Club body was given guidance on the working of Rotaract Clubs and an introduction to rotary.org.com

Activity with news paper coverage if any: Nil

Activity data save in PC of: Department of English



Prof. Pitambar Humane

IQAC Coordinator

COORDINATOR
INTERNAL QUALITY ASSURANCE CELL
DHARAMPETH, M. P. DEO MEMORIAL &
SCIENCE COLLEGE, NAGPUR

Dr. Mrs. Shraddha Deshpande
Teacher In-charge

Dr. Akhilesh Peshwe
Principal

Dharampeth M.P. Deo Memorial
Science College, Nagpur.



DHARAMPETH M.P.DEO MEMORIAL SCIENCE COLLEGE, NAGPUR

ROTARACT CLUB 22-23

Orientation Programme

20 August 2022

Instagram Link:





DHARAMPETH M. P. DEO MEMORIAL SCIENCE COLLEGE,
North Ambazari Road, Near Ambazari Lake, Nagpur- 440033

DATA VALIDATION & VERIFICATION (DVV)

Name of the Programme : Induction Program.
Date of the Programme : 20th August 2022.
Name of ~~the~~ Guest if any : ADRR, Bhavesh Kumbhारे, District sports Joint Director Sharda Mohasil.
Name of Guest Speaker if any : ADRR, Bhavesh Kumbhारे.

Sr. No.	Name of the Participant	Mobile Number	E-mail Id	Signature
1]	Ananya R. Motghare	7219218955	ananya.motghare1802@gmail	Ananya
2]	Nupur M. Sharma	9822042259	nupursharma208@gmail	Nupur
3]	Gargi L. Hodge	7972076671	gargihodge@gmail.com	Gargi
4]	Poojwal Bhoyar	8010434634	poojwalb738@gmail.com	Poojwal
5]	Sania Midhat Raza	8975726700	midhateania@gmail.com	Sania
6]	Dharmapuri Lal	9975037356	dharmapuri.lal@gmail.com	Dharmalal
7]	Vedant Borkar	8530657716	vedantborkar2008@gmail.com	Vedant
8]	Harsh Kodaye	9604571672	harshkodaye008@gmail.com	Harsh
9]	Vaishnavi V. Gadge	9022976449	gadgavaishnavi00@gmail	Vaishnavi
10]	SAHIL SINGH	7258861802	sahilsh06@gmail.com	Sahil

Signature of:

Programme in-charge

CO ORDINATOR
INTERNAL QUALITY ASSURANCE CELL
DHARAMPETH, M. P. DEO MEMORIAL &
SCIENCE COLLEGE, NAGPUR

Principal
Dharampeth M.P. Deo Memorial
Science College, Nagpur.



DHARAMPETH M. P. DEO MEMORIAL SCIENCE COLLEGE,
North Ambazari Road, Near Ambazari Lake, Nagpur- 440033

DATA VALIDATION & VERIFICATION (DVV)

11	Akanksha. K. Kholeagade	7972228707	akankshakholeagade@gmail.com	Akanksha
12	Nitu B. Rai	7058638984	snitu1419@gmail.com	Nitu
13	Vaishnavi N. Tonge	8421657943	Vaishnavitonge004@gmail.com	Vaish
14	Komalika . G. Chaudhari	9322033866	Komalikachaudhari073@gmail.com	Chaudhari
15	Gausi R. Bhoyar	8668335876	gausiarbhojar34@gmail.com	Gausi
16	Dhanashree Neware	9359909913	dhanashreeneware186@gmail.com	Neware
17	Riya Rajbhar	8668619305	riyarajbhar18@gmail.com	Riya
18	Amisha .D. Dalkata	7666559171	Dalkataamisha700@gmail.com	Dalkata
19	Yogita R. Denge	7058437240	yogitadenge@gmail.com	Denge
20	Yacharya K. Pandey	9156035297	pandeykn54@gmail.com	Pandey
21	Priya Dubey	8669465362	dubey.priyapriya@gmail.com	PriyaDubey
22	Kalyani R. Sindram	85610024459	manishakumte11@gmail.com	Sindram
23	Ashalesha R. Khadgi	9096211235	Ashaleshakhadgi@gmail.com	Ashalesha K
24	Sunaina .p. Chichonde	8530970132	Sunainaachichonde123@gmail.com	Chichonde
25	Ritika .R. Sondhiya	9175581655	ritikasondhiya@gmail.com	Ritika

Signature of:

Programme In-charge

CO COORDINATOR
INTERNAL QUALITY ASSURANCE CELL
DHARAMPETH, M. P. DEO MEMORIAL &
SCIENCE COLLEGE, NAGPUR

Principal
Dharampeth M.P. Deo Memorial
Science College, Nagpur.



DHARAMPETH M. P. DEO MEMORIAL SCIENCE COLLEGE,
North Ambazari Road, Near Ambazari Lake, Nagpur- 440033

DATA VALIDATION & VERIFICATION (DVV)

26.	Aasiya Khatun Sabih Hussain	9066411418	asiasabihhussain@894	Ahussain
27.	seidhi Bhagwat Tiwari	8087143696	seidhitiwari072@gmail	seidhi Tiwari
28.	Anjali Kishor Meshram	7767905772	anjali meshram207@gmail.com	Anjali
29.	Chanchal K. Waghware	7796016894	waghwanitara@gmail.com	chanchal
30.	Urnang Gangadhar Wasathi	9322428500	urnangwasathi@gmail.com	Urnang
31.	Harsha N. Vaidya	7588617443	harshavaidya1707@gmail.com	Harsha
32.	Asya Dhoke	9011681628	aynamasaka137@gmail.com	Asya
33.	Anjali .M. Singh	8317296731	anjalisinghas152454@gmail.com	Anjali
34.	Aakasha Y mairal	8020923662	aakayogi2004@gmail.com	Aakasha
35.	Rally K. Nanjari	9326013213	Krishnananjari12345@gmail.com	Rally
36.	Shrawani L. Umari	9284249534	shrawanumari1912@gmail.com	Shrawani
37.	Pranali .Y. Chavhare	9699654567	pranaliclavhare69@gmail.com	Pranali
38.	Sanjana .S. Tabhane	9699186571	tabhanesanjan@gmail.com	Sanju
39.	Rishika Rajesh Kokate	9637554918	kokaterishika@gmail.com	Rishika
40.	Sakshi chaudhary	8766852462	Sakshi chaudhary 111333@gmail.com	Sakshi

Signature of:

Programme In-charge

CO ORDINATOR
INTERNAL QUALITY ASSURANCE CELL
DHARAMPETH, M. P. DEO MEMORIAL &
SCIENCE COLLEGE, NAGPUR

Principal
Dharampeth M. P. Deo Memorial
Science College, Nagpur.



DHARAMPETH M. P. DEO MEMORIAL SCIENCE COLLEGE,
North Ambazari Road, Near Ambazari Lake, Nagpur- 440033

DATA VALIDATION & VERIFICATION (DVV)

41	Rashi Satpute	9145486982	rashisatpute.77@gmail.com	Rashi
42	Bhanashree U. Dhokane	8459807047	ghanashreedhokane@gmail.com	Bhanashree
43	Priya B. Shevkar	8010764549	priyab.19012004@gmail.com	Priya
44	Anjali . R. Thakre	9066554821	thakreanjusa1@gmail.com	Anjali
45	Shruti . R. Chanekar	9699823842	shrutichanekar99@gmail.com	Shruti
46	Khushi S. Bhande	9604367894	2003khushibhande@gmail.com	Khushi
47	Aparna G. Mohare	7020649887	aparnamohare23@gmail.com	Ap. . (CBM)
48	Nikita . S. Das	9604367894	nikitadas970@gmail.com	Nikita (CBM)
49	Ravindra m. Khande	800198277	khandeconvince@gmail.com	Ravindra
50	Chiranjiv . S. Gajbhiye	7196403357	cgajbhiye17@gmail.com	Chiranjiv (CBM)
51	Lucky A Vishwakarma	9579660186	lvishwakarma589@gmail.com	Lucky
52	Anshul Yashraj Minnapure	9284067169	anshulkminnapure650@gmail.com	Anshul
53	Jeet S. Paudhi	7020215431	jeetspaudhi111@gmail.com	Jeet
54	Anvay Borikar	9145401246	anvayborikar2470@gmail.com	Anvay
55	Manthan ^{Madhavan} Todare	7020463916	manthan.todare@gmail.com	Manthan

Signature of:

Programme In-charge



CO-ORDINATOR
INTERNAL QUALITY ASSURANCE CELL
DHARAMPETH, M. P. DEO MEMORIAL &
SCIENCE COLLEGE, NAGPUR



Principal
Dharampeth M.P. Deo Memorial
Science College, Nagpur.



DHARAMPETH M. P. DEO MEMORIAL SCIENCE COLLEGE,
North Ambazari Road, Near Ambazari Lake, Nagpur- 440033

DATA VALIDATION & VERIFICATION (DVV)

56.	Somyak Hadke	7020171304	Somyakhadke30@gmail.com
57.	Khushi.K.Rewade	9588445994	Khushikrewade@gmail.com Rewade
58.	TANU .AJAY .SINGH	8806855808	tanusingh68499@gmail.com ← Tanu
59.	Mahima Khare	9545918678	mahimakhare11@gmail.com Khare
60.	Avishkar A. Bansod	7820541788	avishkarbansod02@gmail.com A.A.Bansod
61.	Harshad Wasthi	7414993575	harshadwasthi3592@gmail.com Wasthi
62.	Ashlesha Sangole	9509998469	Ashleshasangole94@gmail.com Sangole
63.	Nikita Pralapati	7058625053	nikitapralapati@gmail.com Pralapati
64.	Simran Chitale	7666330683	simranchitale80@gmail.com Chitale

Signature of:

Programme In-charge

CO ORDINATOR
INTERNAL QUALITY ASSURANCE CELL
DHARAMPETH M. P. DEO MEMORIAL &
SCIENCE COLLEGE, NAGPUR

Principal
Dharampeth M.P. Deo Memorial
Science College, Nagpur.



DHARAMPETH M. P. DEO MEMORIAL SCIENCE COLLEGE, NAGPUR
INTERNAL QUALITY ASSURANCE CELL (IQAC)
Activity Report

Date: 25/08/2022

Name of Organizing Department or Committee: Microbiology Department

Name of the activity: Alumni interaction

Suggested CRITERION point if any: Criterion II and V

Date of Activity: 24/08/2022

Place of Activity: Microbiology Laboratory

Name of Guest Speaker/s or Judge/s or Chief Guest/s if any: Guest Speaker- Sharang Nimonkar .

Title of the Activity: Book Donation and Interaction of alumni with students.

Number of Participants: 6

Name of the Teacher In-charge / Convener: Dr. Vidya R. Kathoke

Names of other Committee Members / Staff:

OUTCOME of the Activity with respect to mission vision of the institute and or academics:

To enhance the attachment & interaction of alumnus with the College.

The interaction of alumnus with the students will help in motivation or create interest in science field as well as in research field in India or abroad.

It will help to solve the doubts or queries of the students if they wish to study abroad through their guidance.

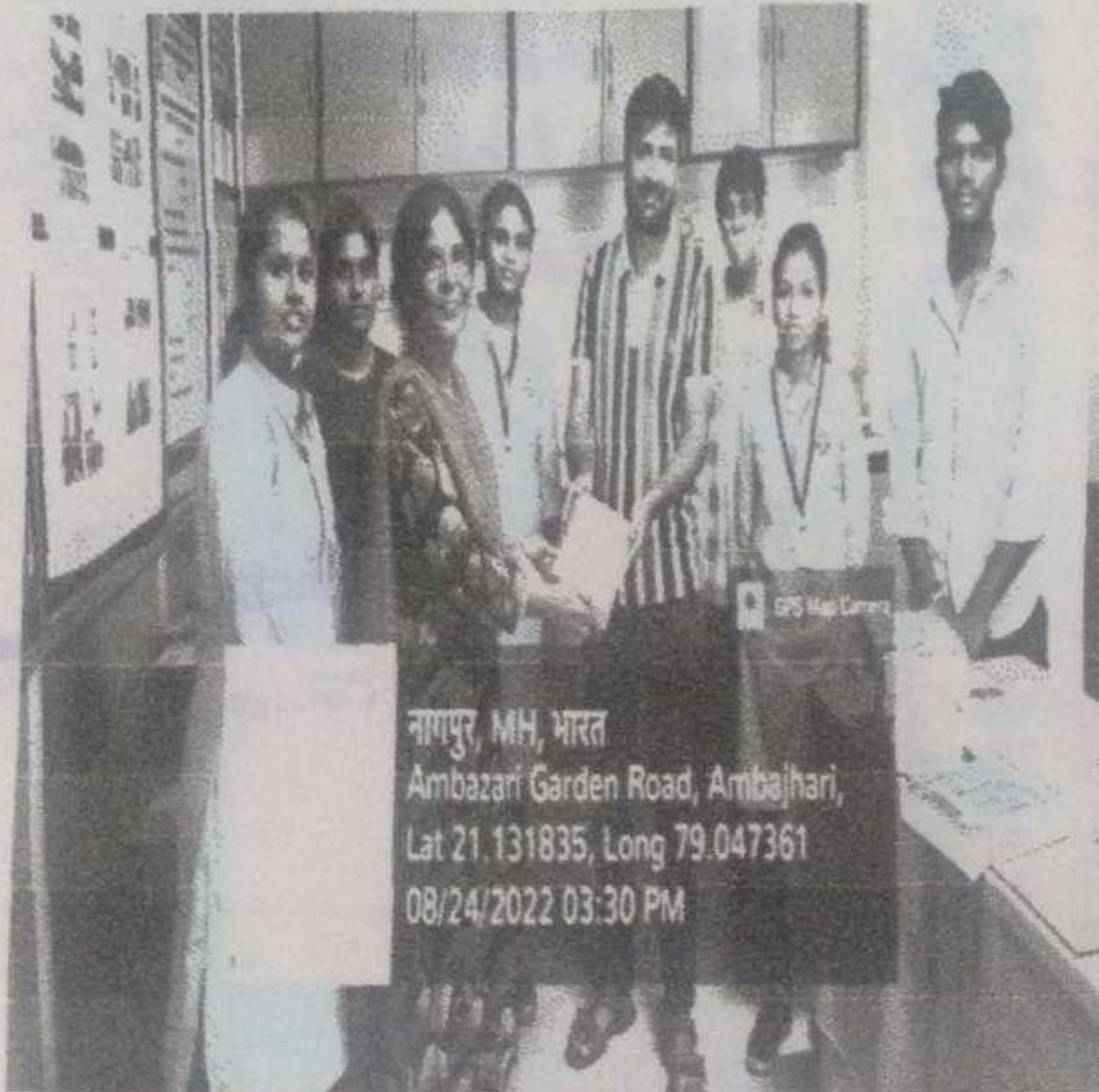

Prof. Pitambar Humane
IQAC Coordinator

Dr. Vidya R. Kathoke
Name & Signature of Teacher In-charge

Dr. Akhilesh Peshwe
Principal



DHARAMPETH M. P. DEO MEMORIAL SCIENCE COLLEGE,
North Ambazari Road, Near Ambazari Lake, Nagpur- 440033

DATA VALIDATION & VERIFICATION (DVV)

Name of the Programme : Book Donation and Interaction of Alumni with Students
Date of the Programme : 24/08/2022
Name of Chief Guest if any : Shriyansh Nimonkar
Name of Guest Speaker if any : Shriyansh Nimonkar Sem I

Sr. No.	Name of the Participant	Mobile Number	E-mail Id	Signature
1.	Shriyansh Lalchand Umare	9284249534	shriyanshumare1912@gmail.com	
2.	Arya Dhoke	9011681628	aryadhoke1331@gmail.com	
3.	Ravindra M. Khadse	8007198273	khadse2ravindra892@gmail.com	
4.	Komalika S. Chaudhari	9322033866	KomalikaChaudhari073@gmail.com	
5.	Anjali R. Thakre	7066554821	thakreanj4331@gmail.com	

Signature of:

Programme In-charge

IQAC Coordinator

Principal
Dharampeth M. P. Deo Memorial
Science College, Nagpur



DHARAMPETH M. P. DEO MEMORIAL SCIENCE COLLEGE,
North Ambazari Road, Near Ambazari Lake, Nagpur- 440033

DATA VALIDATION & VERIFICATION (DVV)

3rd Sem (2nd year)

1)	Komalika. S. Chaudhari	9322033866	Komalika.chaudhari73@gmail.com	
2)	Mansi. I. Mate	8468891807	Mansi19182@gmail.com	
3)	Jaguti Dhanraj Warkar	7447366023	jagutiwarkar309@gmail.com	
4)	Juhi S. Chaudhari	8669248944	chaudharijuhi120@gmail.com	Juhi
5)	Sakshi. S. Meshram.	9145355733.	meshram.sakshi210@gmail.com	

Signature of:

Programme In-charge

IQAC Coordinator

Principal
Dharampeth M. P. Deo Memorial
Science College, Nagpur



Dharampeth M.P. Deo Memorial science College, Nagpur
Academic Session: 2022-2023
DEPARTMENT OF MICROBIOLOGY
Books Donated by Our Alumni
Mr. Sharang Nimonkar

1. Enzymes- Biochemistry, Biotechnology, Clinical Chemistry
-by Trevor Palmer
2. Fundamentals of Biochemistry
-by J. L. Jain, Sanjay Jain, Nitin Jain
3. Principles of Genetics [8th edition]
-by Gardner, Simmons, Snustad
4. Biophysical Chemistry [Principles and Techniques]
-by Upadhyay, Nath [Himalaya Publishing House]
5. General Microbiology Vol-II
-by Pawar and Daginawala [Himalaya Publishing House]
6. R. Gupta's Popular Master Guide
M.Sc. Biotechnology Entrance Examination
[Ramesh Publishing House, New Delhi]
7. Mol Bio [Fundamentals of Molecular Biology]
-by Avinash and Kakoli Upadhyay [Himalaya Publishing House]
8. Genetics [A conceptual Approach]
-by Benjamin A. Pierce
9. Biochemistry Lehninger [2nd edition]
-by Albert Lehninger
10. Nootan ISC Physics XII
-by Kumar, Mittal [Nageen Prakashan]



DHARAMPETH M. P. DEO MEMORIAL SCIENCE COLLEGE, NAGPUR
INTERNAL QUALITY ASSURANCE CELL (IQAC)

Activity Report

Date: 30/08/2022

Name of Organizing Department or Committee: Chemistry

Name of the activity: Bridge course

Suggested CRITERION point if any: I

Date of Activity: Place of Activity: 29/08/2022 Chemistry Laboratory

Name of Guest Speaker/s or Judge/s or Chief Guest/s if any: NO

Title of the Activity: Bridge course for Sem I students with chemistry subject

Number of Participants: 105

Name of the Teacher In-charge / Convener: Dr Vaishali Meshram

Names of other Committee Members / Staff: Dr Pranita Gawande & Dr Mrunal Gawande

OUTCOME of the Activity with respect to mission vision of the institute and or academics:

Bridge course which was conducted at the beginning of the session students were aware about the lab safety, AR, LR, GR grade chemicals How to handle the toxic chemicals, what type of precautions taken during the practical, also they learned about the analytical balance operation and details about the instruments which are generally used in chemistry lab.

Activity with newspaper coverage if any: Nil

Activity data save in PC of: _Chemistry

Note: Kindly share geotag photographs separately along with report on ijqacdsc2022@gmail.com



Dr. Vaishali P. Meshram
Dr. Vaishali P. Meshram
Name & Signature of Teacher In-charge

Prof. Pitambar Humane

Prof. Pitambar Humane
IQAC Coordinator
CO ORDINATOR
INTERNAL QUALITY ASSURANCE CELL
DHARAMPETH, M. P. DEO MEMORIAL &
SCIENCE COLLEGE, NAGPUR

Dr. Akhilesh Peshwe

Dr. Akhilesh Peshwe
Principal
Principal
Dharampeth M.P. Deo Memorial
Science College, Nagpur.



DHARAMPETH M. P. DEO MEMORIAL SCIENCE COLLEGE,
North Ambazari Road, Near Ambazari Lake, Nagpur- 440033

DATA VALIDATION & VERIFICATION (DVV)

Name of the Programme : Bridge Course
Date of the Programme : 29/08/22
Name of Chief Guest if any : -
Name of Guest Speaker if any : -

Sr. No.	Name of the Participant	Mobile Number	E-mail Id	Signature
1	Pratiksha Meshram	8459070338	meshrampratiksha@gmail.com	
2	Nihal V. Meshram	8767792960	nihalmeshram74@gmail.com	
3	Neha S. Wanjari	9313832266	nehawanjari32@gmail.com	
4	Aakansha Y. Maitra	8020923662	aakanshamaitra@gmail.com	
5	Pratibha Bhusari	7821048413	pbhusari718@gmail.com	
6	Shivam Patel	7038889083	sp040263@gmail.com	
7	Saurabh Chaudhary	9766341962	Schaudhary5579@gmail.com	
8	Ruchi Dwivedi	8080776893	Ruchidwivedi23@gmail.com	
9	Gunjan J. Bhayore	7666799586	gunjanbhayore@gmail.com	
10	Ankit R. Patel	9970905638	ankitpatel797295@gmail.com	

Signature of:

Programme In-charge

IQAC Coordinator

CO ORDINATOR

INTERNAL QUALITY ASSURANCE CELL
DHARAMPETH, M. P. DEO MEMORIAL &
SCIENCE COLLEGE, NAGPUR

Principal

PRINCIPAL

Dharampeth M.P. Deo Memorial
Science College, Nagpur-440033



DHARAMPETH M. P. DEO MEMORIAL SCIENCE COLLEGE,
North Ambazari Road, Near Ambazari Lake, Nagpur- 440033

DATA VALIDATION & VERIFICATION (DVV)

11)	Chiranjiv S. Gajbhaye	8329412694	cgybhitel7@gmail.com	Chiranjiv
12)	Khushi K. Rewade	9888445934	khushikrewade@gmail.com	K. Rewade
13)	Chanchal K. Waghwarani	7796016894	waghwaranichanchal@gmail.com	chanchal
14)	Shruti S. Channekar	7720959269	shrutichannekar10@gmail.com	Shruti
15)	Priyanshi L. Meshram	7888080054	priyanshimeshram85@gmail.com	P. L. Meshram
16)	Geetika R. Bhojare	8668335876	geetikabhojare34@gmail.com	Geetika
17)	Apeksha D. Katangale	7559455794	apekshakatangale26@gmail.com	A. Katangale
18)	Dhanashri Newam	9859909913	dhanashrinewam20@gmail.com	Dhanashri
19)	Muskan Kulkarni	9156879239	muskanikulkarni@gmail.com	Muskan
20)	Umanj Wadhi	9322428500	umanj@gmail.com	Umanj
21)	Kartika Deshmukh	9699720960	kartikadeshmukh20@gmail.com	Kartika
22)	Ritika Sondhiy	9175581655	ritikasondhiy9@gmail.com	R. Sondhiy
22)	Vadvi Tuote	7558499191	vadvituote@gmail.com	Vadvi
24)	Ashwini A. Lanjewar	9689117254	lanjewarashwini111@gmail.com	Ashwini
25)	Monika T. Patel	7499225468	monikapatel703@gmail.com	Monika T. Patel
26)	Anjali R. Thakre	7066554821	thakreanjur381@gmail.com	Anjali

Signature of:

Programme In-charge

IQAC Coordinator

CO ORDINATOR
INTERNAL QUALITY ASSURANCE CELL
DHARAMPETH, M. P. DEO MEMORIAL &
SCIENCE COLLEGE, NAGPUR

Principal
PRINCIPAL

Dharampeth M. P. Deo Memorial
Science College, Nagpur-440033



DHARAMPETH M. P. DEO MEMORIAL SCIENCE COLLEGE,
North Ambazari Road, Near Ambazari Lake, Nagpur- 440033

DATA VALIDATION & VERIFICATION (DVV)

127	Aakasha. K. Khatragade	7972228707	aakashakhatragade@gmail	Aakasha
128	Shrutiika G. Pise	9329316330	shrutiikapise67@gmail.com	Shrutiika
139	Arpita. T. Kusram	9637226848	Arpita.kusram23@gmail.com	Arpita
140	Praty. K. Wanjari	9926019213	Ksatitna.wanjari123@gmail.com	Praty
141	Yashashree. A. Pawar	9359117016	Yashashreepawar37@gmail.com	Yashashree
142	Sanjana. S. Tabhane	9699186571	tabhane.sanjana@gmail.com	Sanjana
143	Sakshi. S. Chaudhary	8766852462	Sakshichaudhary743@gmail.com	Sakshi
44	Ritika. R. Bhojar	9834587087	ritikabhoyar27@gmail.com	Ritika
45	Shital. D. Patte	9764596337	shitalpatte9855@gmail.com	Shital
46	Nisha. V. Pandey	8605231390	abhishek.8605231390@gmail.com	Nisha
47	Lucky A Vishwakarma	9579660186	lvishwakarma25@gmail.com	Lucky
48	Pranali. Y. Chavhare	9699652562	pranalicavhare69@gmail.com	Pranali
49	Sejal D. Kolhe	8483045995	kolhesejal04@gmail.com	Sejal
50	Rashi. Saipute	7498796164	Rashi.saipute11@gmail.com	Rashi
51	Kemalika. S. Chaudhari	9322033866	Kemalika.chaudhari73@gmail.com	Kemalika
52	Vaishnavi N. Tonge	8421657943	Vaishnavitonge2004@gmail.com	Vaishnavi

Signature of:

Programme In-charge

CO-ORDINATOR

INTERNAL QUALITY ASSURANCE CELL
DHARAMPETH, M. P. DEO MEMORIAL &
SCIENCE COLLEGE, NAGPUR

Principal

PRINCIPAL

Dharampeth M.P. Deo Memorial
Science College, Nagpur-440033



DHARAMPETH M. P. DEO MEMORIAL SCIENCE COLLEGE,
North Ambazari Road, Near Ambazari Lake, Nagpur- 440033

DATA VALIDATION & VERIFICATION (DVV)

53.	Anvay Borhade	9168538614	Anvay Borhade 19 @gmail.com	
54.	Paroon S. Thakre	8262963715	thakre27pccv1973@gmail.com	
55.	Nikhil R. Kumbre	9130890325	Nikhil.kumbre@gmail.com	
56.	Mrunali D. Bhilkar	9322727616	mrunalibhilkar@gmail.com	
57.	Karishma N. Prasad	9309318667	namendraprasad72@gmail.com	
58.	Ashwini R. Chaudhary	9699792732	chaudharyashwini28@gmail.com	
59.	khineshwari R. Pushptode	8624976072	khineshwaripushptode@gmail.com	
60.	Priya Bhugwan Sharma	8610764544	priyasharma1903@gmail.com	
61.	Ashika Husain	9351259791	ashika1903@gmail.com	
62.	Ghanshyam U. Dhamane	7174900320	ghanshyamdhamane@gmail.com	
63.	Yogita R. Denge	7058437240	yogitadenge@gmail.com	
64.	Riya A. Singh	9595649731	riyaad27@gmail.com	
65.	Shreya A. Jha	8983238002	shreya@1303@gmail.com	
66.	Aufati Meshram	8855819748	aufatimeshram2024@gmail.com	
67.	Sonal Chaudhary	885055003	sonalchaudhary1903@gmail.com	
68.	Siddhi Tiwari	8087143696	Siddhitiwari0721@gmail.com	

Signature of:

Programme In-charge

CO ORDINATOR
INTERNAL QUALITY ASSURANCE CELL
DHARAMPETH, M. P. DEO MEMORIAL &
SCIENCE COLLEGE, NAGPUR

Principal

PRINCIPAL

Dharampeth M.P. Deo Memorial
Science College, Nagpur-440033



DHARAMPETH M. P. DEO MEMORIAL SCIENCE COLLEGE,
North Ambazari Road, Near Ambazari Lake, Nagpur- 440033

DATA VALIDATION & VERIFICATION (DVV)

68	Vogita K. Thakre	78410244463	vogitathakre2584@gmail.com	(V)Thakre
69	Kalyani R. Sindram	84416539622	Sindramkalyani@gmail.com	(S)Sindram
70	Rohan H Meshram	7499956761	rohannmeshram353@gmail.com	(R)Meshram
71	Samyaks M. Hadke	7020171304	samyakshadke30@gmail.com	(S)Hadke
72	Ravindra, Khadse	8007148273	ravindra.khadse@gmail.com	(R)Khadse
73	Prityanshu Raut	9322725233	prityanshuraute55@gmail.com	(P)Raut
74	Anshul Kinnapure	9168538614	anshulkinnapure65@gmail.com	(A)Kinnapure
75	Durgesh K. Ghodmare	9075318618	durgeshghodmare@gmail.com	(D)Ghodmare
76	Vaishali M. Sahare	7972925403	Vaishalisahare251@gmail.com	(V)Sahare
77	Abhay P. Tembhare	8975363145	abhay220102@gmail.com	(A)Tembhare
78	Nitu B. Rai	7058638984	nitu1419@gmail.com	(N)Rai
79	Sunaina Chichonde	8530970132	Sunainachichonde@gmail.com	(S)Sunaina
80	Aparna Mohare	7020649887	aparnamohare23@gmail.com	(A)Mohare
81	Arya Dhope	9011681628	Aryanamrata1331@gmail.com	(A)Dhope
82	Vanila Bhande	9370673867	bhandevanila_200@gmail.com	(V)Bhande
83	Shreyas Dhande	8888-02404	ShreyasDhande124@gmail.com	(S)Dhande

Signature of:

Programme In-charge

IQAC COORDINATOR
INTERNAL QUALITY ASSURANCE CELL
DHARAMPETH, M. P. DEO MEMORIAL &
SCIENCE COLLEGE, NAGPUR.

Principal
PRINCIPAL
Dharampeth M. P. Deo Memorial
Science College, Nagpur-440033



DHARAMPETH M. P. DEO MEMORIAL SCIENCE COLLEGE,
North Ambazari Road, Near Ambazari Lake, Nagpur- 440033

DATA VALIDATION & VERIFICATION (DVV)

Name of the Programme : Bridge course
Date of the Programme : Bridge course for sem I 29/8/2022
Name of Chief Guest if any : -
Name of Guest Speaker if any : -

Sr. No.	Name of the Participant	Mobile Number	E-mail Id	Signature
1	Samiksha N. Kunderkar	9145253158	samikshakunderkar@gmail.com	
2	Samiksha R. Chaudhari	7517090408	chaudharsamiksha26@gmail.com	
3	Madhura U. Bhandure	8767484914	MadhuraBhandure@gmail.com	
4	Bhumnika D. Chedge	8830391103	bhumnikachedge@gmail.com	
5	Vivek R. Waghmare	8956482591	vivekcoaherwaghmare@gmail.com	
6	Sayli S. Lokhande	9356413864	saylilokhande2910@gmail.com	
7	Sanstuti S. Panibhau	7447613185	sanstuti.panibhau@gmail.com	

Signature of

Programme In-charge

COORDINATOR
IQC COORDINATOR ASSURANCE CELL
DHARAMPETH, M. P. DEO MEMORIAL &
SCIENCE COLLEGE, NAGPUR

PRINCIPAL
Dharampeth M. P. Deo Memorial
Science College, Nagpur-440033



DHARAMPETH M. P. DEO MEMORIAL SCIENCE COLLEGE,
North Ambazari Road, Near Ambazari Lake, Nagpur-440033

DATA VALIDATION & VERIFICATION (DVV)

1)	Sanali G. Chaudhawi	8856055003	sanalichaudhawi19@gmail.com	Chaudhawi
2)	Pratiksha Meshram	8459070338	meshrampratiksha11	meshram
3)	Ritika Sondwya	9175581655	ritikasondwya@gmail.com	Ritika
4)	Riddhi B. Tiwari	8087143696	riddhitiwari0721@gmail.com	Riddhi Tiwari
5)	Ritika R. Bhayav	9894587087	Ritikabhayav20@gmail.com	Ritika
6)	Ruchi Dwivedi	8080776849	Ruchidwivedi230@gmail.com	Ruchi
7)	Shivam U. Patel	7038889083	sp040263@gmail.com	Shivam
8)	Pratibha B. Bhusari	7821048413	pbhusari718@gmail.com	Pratibha
9)	Ankit R. Patel	9920905638	ankitpatel77275@gmail.com	Ankit
10)	Monika J. Patel	7499225668	monikapatel7039@gmail.com	Monika
11)	Yogita K. Thakre	78411024443	Yogitathakre2584@gmail.com	Yogita
12)	Shruti K. Pise	9322316336	shrutikapise67@gmail.com	Shruti
13)	Vaidehi Thote	755849919	Vaidehitote21@gmail.com	Vaidehi
14)	Umang G. Wankar	9322428500	umangwankar@gmail.com	Umang
15)	Kaantika Deshmukh	9699720960	Kaantikadeshmukh@gmail.com	Kaantika
16)	Durgesh K. Ghodmare	9075318618	durgeshghodmare011@gmail.com	Durgesh

Signature of:

Programme In-charge

IQAC Coordinator
CO ORDINATOR
INTERNAL QUALITY ASSURANCE CELL
DHARAMPETH, M. P. DEO MEMORIAL &
SCIENCE COLLEGE, NAGPUR

Principal
PRINCIPAL
Dharampeth M.P. Deo Memorial
Science College, Nagpur-440033



DHARAMPETH M. P. DEO MEMORIAL SCIENCE COLLEGE, NAGPUR
DEPARTMENT OF COMPUTER SCIENCE
ACADEMIC SESSION: 2022-23

NOTICE

20th August 2022

All the students of B.Sc.[SEM I] are hereby informed that the Department of Computer Science, Dharampeth M.P.Deo Memorial Science College, Nagpur is going to organize IIT Spoken Training Program on 1st September 2022. All the students those who have admitted for IIT spoken Tutorial Certificate Course must remain present for the training program.

Venue : Room No 01
Time : 2.00pm

PRINCIPAL
DHARAMPETH M.P.DEO
MEMORIAL SCIENCE COLLEGE
NAGPUR

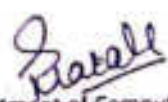
Head, Department of Computer Science
Dr. Snehal Narale
Course Co-ordinator
Spoken Tutorial/IIT Bombay
NMEICT, MOE, GOI



DHARAMPETH M. P. DEO MEMORIAL SCIENCE COLLEGE, NAGPUR
INTERNAL QUALITY ASSURANCE CELL (IQAC)

Activity Report

Date: 29th September 2022

Name of Organizing Department or Committee: Computer Science Department

Name of the activity: Training Program

Suggested CRITERION point if any: Criteria II, V, VI

Date of Activity: 01/09/2022

Place of Activity: Room No. 001

Name of Guest Speaker/s or Judge/s or Chief Guest/s if any: Nil

Title of the Activity: IIT Spoken Tutorial

Number of Participants: 65

Name of the Teacher In-charge / Convener: Dr.Mrs.Snehal Narale

Names of other Committee Members / Staff: Nil

OUTCOME of the Activity with respect to mission vision of the institute and or academics:

The main aim of conduction of this training program is provides platform to the students where they can learn and master on various programming languages and software including C, C++, JAVA, JBA, Pyhton, PHP & MySQL, LINUX, LibreOffice, BASH, Scilab, LaTeX, Drupal, Perl, Neatbeans (approx. 45 programming languages and software's are available to learn)

The following are some of the benefits which students get from the training program like :

1. Students will be able to know how to write program, compiling and running in different computer Languages
2. They will able to understand the complete process of IIT Spoken Tutorial [NMEICT, GOI] training and certification.
3. Students will be able to understand the working flow of final online examination.
4. Listening is better than reading and that why methodology works
3. Students will be able to understand the basic program concept how to practice it and do in a simple way.

Activity with newspaper coverage if any: Nil

Activity data save in PC of: Dr. Mrs. Snehal Narale's Laptop



Prof.Pitambar Humane
IQAC Coordinator
IQAC Co-ordinator
Dharampeth M.P. Deo Memorial
Science College, Nagpur-440033

Dr.Mrs.Snehal Narale
Name &Signature of Teacher In-charge

Dr.AkhileshPeshwe
Principal
PRINCIPAL
Dharampeth M.P. Deo Memorial
Science College, Nagpur-440033



DHARAMPETH M. P. DEO MEMORIAL SCIENCE COLLEGE,
North Ambazari Road, Near Ambazari Lake, Nagpur- 440033

DATA VALIDATION & VERIFICATION (DVV)

Name of the Programme : Training program : IIT Spoken Tutorial
Date of the Programme : of September 2022
Name of Chief Guest if any : _____
Name of Guest Speaker if any : _____

Sr. No.	Name of the Participant	Mobile Number	E-mail Id	Signature
1)	Tejas Dongre	9322578918	Tejasdongre453@gmail.com	<u>Tejas</u>
2)	Vedant D. Unakhe	9049932753	vedantvedant@gmail.com	<u>Tejas</u>
3)	Tanvi M. Joge	7249790035	TanviJoge08@gmail.com	<u>Tanvi</u>
4)	Sakshi F. Mishra	9158788969	Smishra39683@gmail.com	<u>S. Mishra</u>
5)	BADAL G. SOMKUWAR	7448247750	badalsonkuwar1@gmail.com	<u>Badal</u>
6)	Nayan N. Walthe	7841870947	Nayanwalthe214@gmail.com	<u>Nayan</u>
7)	Deepak Kumar	7061735473	DeepakSharma092	<u>Deepak Kumar</u>
8)	Aniket K. Kumbhar	8262817299	aniketkumbhar@gmail.com	<u>Aniket</u>
9)	Ankit R. Patel	9970905638	ankitpatel79323@gmail.com	<u>Ankit</u>
10)	Shivam V. Patel	7038889083	sp040863@gmail.com	<u>Shivam</u>

Signature of:

Ravale

Programme In-charge
Dr. Sushil Ravale
Course Co-ordinator
Spoken Tutorial/ IIT Bombay
NISECT, MOE, GOI

[Signature]

IOAC Co-ordinator
CO ORDINATOR
INTERNAL QUALITY ASSURANCE CELL
DHARAMPETH, M. P. DEO MEMORIAL &
SCIENCE COLLEGE, NAGPUR

[Signature]

Principal
Principal
Dharampeth M. P. Deo Memorial
Science College, Nagpur



DHARAMPETH M. P. DEO MEMORIAL SCIENCE COLLEGE,
North Ambazari Road, Near Ambazari Lake, Nagpur-440033

DATA VALIDATION & VERIFICATION (DVV)

1)	Aniket J. Bawankar	9767219301	Bawankaraniket@55@gmail.com	Bawankar
2)	Atul J. Inakre	9881956597	Inakre.devisingh@gmail.com	Inakre
13)	Wineet. Mukesh. Singh	7558426949	Singh.wineet@gmail.com	Wineet
14)	Trishabh. D. Sahi	7386310571	trishabh.sahi2004@gmail.com	Sahi
15)	Abhishek H. Hiranwar	9529288243	Abhishek.hiranwar2165@gmail.com	Hiranwar
16)	Sayrabh Chandhary	9354883501	Schindhary557@gmail.com	Chandhary
17)	Rishik H. Hiranwar	7498066429	Rishik.hiranwar57@gmail.com	Hiranwar
18)	Vidya Ekroth Lohi	7020968279	Vidyalohi8@gmail.com	Lohi
19)	Kaishik Kamal Kumar Bisen	7887886114	Kaishikbisen05@gmail.com	Bisen
20)	Khushi Ro Pali	8767607224	Rohitkhal11@gmail.com	Pali
21)	Khushi Pali	8459565214	pali.khushi59@gmail.com	Pali
22)	Ruchi Juvvedi	8080776893	Ruchijuvvedi20@gmail.com	Juvvedi
23)	Aayushi V. Singh	7498985604	Singh.aayushi7409@gmail.com	Singh
24)	Pooja R. Debnikar	8767581278	Pletrna@gmail.com	Debnikar
25)	Nisha S. Kasarkare	9830996645	Nishakasarkare32@gmail.com	Kasarkare

Signature of: Ratale
Ranhal Narale
Incharge
Spoken ...
Dombay
ISMEICT, No. ...

Amr P.
CO ORDINATOR
INTERNAL QUALITY ASSURANCE CELL
DHARAMPETH, M. P. DEO MEMORIAL &
SCIENCE COLLEGE, NAGPUR

to
Principal
Dharampeth M. P. Deo Memorial
Science College, Nagpur



DHARAMPETH M. P. DEO MEMORIAL SCIENCE COLLEGE,
North Ambazari Road, Near Ambazari Lake, Nagpur - 440033

DATA VALIDATION & VERIFICATION (DVV)

26)	Vaidhvi Babasaheb Gogol	750907278	gogolvaidhvi@gmail.com	Gogol
(27)	Sandeep Kumar	8081194948	Sandeepk27700@gmail.com	(Pran)
28)	Mrit Mani Khadkekar	8055328357	mritkhadkekar@gmail.com	Khadkekar
29)	Ved. Sudhir Chaudhary	7498572766	vedchoudhary.cs.749@gmail.com	(Ved)
30)	TANU. HITAY. SINGH	8806855808	tanusingh163499@gmail.com	Tanu
31)	Tapanti G. Fulkarwar	8767911807	tapantifulkarwar@gmail.com	Fulki
32)	Arju Sanjeev Rai	8149194497	arju08@gmail.com	Rai
33)	Prarali Vipin Gupta	7020069377	kg.991537@gmail.com	Gupta
34)	Jashvi A. Keshavnare	7058235243	jashvikeshavnare@gmail.com	Keshavnare
35)	Utkarsha Sanjay Jagade	7499159178	utkarshajagade9@gmail.com	Jagade
36)	Biyyani Vithal Jagade	9022966318	biyyanivijagade@gmail.com	Biyagade
37)	Prachi G. Pardhi	7263935912	prachipardhi282@gmail.com	P.G.P.
38)	Aimvan N. Dhivale	9284583851	aimvanlaxmi210@gmail.com	Dhivale
39)	Veena W. Borikar	9322016924	veena.borikar.14@gmail.com	veena
40)	Rutika G. Yadav	8446085943	yadavarutika434@gmail.com	Yadav

Signature of:

Sakale

Arul

Dr. Santhol Narale
Programme In-charge
Course Co-ordinator
Spoken Tutorial@IT Bombay
MREICT, MCE, GOI

CO ORDINATOR
IQC Coordinator
INTERNAL QUALITY ASSURANCE CELL
DHARAMPETH M. P. DEO MEMORIAL &
SCIENCE COLLEGE, NAGPUR

Principals
Principal
Dharampeth M.P. Deo Memorial
Science College, Nagpur.



DHARAMPETH M. P. DEO MEMORIAL SCIENCE COLLEGE,
North Ambazari Road, Near Ambazari Lake, Nagpur- 440033

DATA VAUDATION & VERIFICATION (DVV)

41)	Vansha Tukkar	9373650950	vanshatukkar488@gmail.com	Vansha
42)	pradnya Tispuke	8010362232	pradnyatipude914@gmail.com	Pradnya
43)	Sonia Niwal	7058425022	Niwalsonia70@gmail.com	Sonia
44)	Samiksha A. Panchbudhe	9763075890	samikshapanchbudhe33@gmail.com	S.Panchbudhe
45)	Taruni Y. KHODE	77395066634	Tarunikhode892@gmail.com	Taruni
46)	Meghna S. Ballav	9421728880	meghnaaballav04@gmail.com	M.Ballav
47)	Aditi S. Jogi	9579962108	aditi.jogi2002@gmail.com	Aditi
48)	Shital O. Patle	9158019447	ShitalPatle@gmail.com	Shital
49)	Mrunali D. Bhilkar	9322727676	mrunalibhilkar@gmail.com	M.Bhilkar
50)	Chetna S. Bawale	8010342968	bawalechetna@gmail.com	Chetna
51)	Tisha T. Waghmare	8855919474	Tishawaghmare9474@gmail.com	Tisha
52)	Shreyan G. Bhimte	9637762811	ShreyanBhimte1@gmail.com	Shreyan
53)	Khushiwarvi R. Purohitade	8624976072	khushiwarvi.purohitade@gmail.com	Khushi
54)	Vaishali M. Sabare	7977925403	vaishalisabare251@gmail.com	Vaishali
55)	Manu P. Pal	7350450579	manupal3350450@gmail.com	Manu

Signature of:

Dr. Suchal Narale

Dr. Suchal Narale
Programme In-Charge
Course Co-ordinator
Spoken Tutorial/IIT Bombay
NMEICT, MCE, GOI

Dr. Suchal Narale

COORDINATOR
INTERNAL QUALITY ASSURANCE CELL
DHARAMPETH, M. P. DEO MEMORIAL &
SCIENCE COLLEGE, NAGPUR

Dr. Suchal Narale

Principal
Principal
Dharampeth M.P. Deo Memorial
Science College, Nagpur



DHARAMPETH M. P. DEO MEMORIAL SCIENCE COLLEGE,
North Ambazari Road, Near Ambazari Lake, Nagpur - 480013

DATA VALIDATION & VERIFICATION (DVV)

56)	Priyanshu P. Singh	9527710380	Priyanshusingh12012@gmail.com	P Singh
57)	Gendral B. Machade	911242228	nikhilmachade2005@gmail.com	Gendral Machade
58)	Jashvi H. Labe	8446510539	Jhanshikabe@gmail.com	Jashvi
59)	Tushar R. Achane	9075995617	tushar15@gmail.com	Tushar
60)	Anan S. Kazi	9028837552	kazn717@gmail.com	Anan
61)	Pratik D. Chalak	9021640532	pratikchalak007@gmail.com	Pratik
62)	Vijay U. Kumbhar	9373163514	vijaykumbhar2002@gmail.com	Vijay
63)	Nikhil S. Kale	9528113941	nikhilkale@gmail.com	Nikhil
64)	Shikha Sullipandi	9130091540	shikhadoshparde2006@gmail.com	Shikha
65)	Rahul S. Pandey	8767788703	rpj356521@gmail.com	Rahul

Signature of:

Dr. Chakal Narala
Programme In-charge
Course Co-ordinator
Bhopal Tutorial/IT Bombay
INHERIT MOE, GOI

COORDINATOR
CENTRAL QUALITY ASSURANCE CELL
DHARAMPETH, M. P. DEO MEMORIAL &
SCIENCE COLLEGE, NAGPUR

Principal
Dr. Manoj K. P. Deo
Jyoti Chitwan, Nagpur



DHARAMPETH M. P. DEO MEMORIAL SCIENCE COLLEGE, NAGPUR
INTERNAL QUALITY ASSURANCE CELL (IQAC)

Activity Report

Date: 11/08/2022

Name of Organizing Department or Committee: Chemistry department

Name of the activity: Aptitude Test for B. Sc Sem I students

Suggested CRITERION point if any: I

Date of Activity: 1st Sept to 10th Sept 2022

Place of Activity: Department of Chemistry Laboratory

Name of Guest Speaker/s or Judge/s or Chief Guest/s if any: Nil

Title of the Activity: Aptitude Test for B. Sc Sem I for the subject Chemistry

Number of Participants: 130

Name of the Teacher In-charge / Convener: Dr. Vaishali Meshram

Names of other Committee Members / Staff: Dr. Mrudul Keskar

Dr. Pranita Gawande

Dr. Tanishq Chaudhary

OUTCOME of the Activity with respect to mission vision of the institute and or academics:

Due to aptitude test conducted for sem I students for the subject Chemistry students those who were scored good marks they were very much interested in the subject chemistry and those who scored less marks they identified on the basis of aptitude test .

Activity with newspaper coverage if any: Nil

Activity data save in PC of: Chemistry

Note: Kindly share geotag photographs separately along with report on iqacdisc2022@gmail.com

Prof. Pitambar Humane
IQAC Coordinator

CO ORDINATOR
INTERNAL QUALITY ASSURANCE CELL
DHARAMPETH, M. P. DEO MEMORIAL &
SCIENCE COLLEGE, NAGPUR

Name & Signature of Teacher In-charge

Dr. Akhilesh Peshwe
Principal

PRINCIPAL
Dharampeth M.P. Deo Memorial
Science College, Nagpur-440022



DHARAMPETH M. P. DEO MEMORIAL SCIENCE COLLEGE,
North Ambazari Road, Near Ambazari Lake, Nagpur- 440033

DATA VALIDATION & VERIFICATION (DVV)

Name of the Programme : Aptitude Test for B.Sc. Sem I students
Date of the Programme : 1st Sept - 10th Sept 2022
Name of Chief Guest if any : _____
Name of Guest Speaker if any : -

Sr. No.	Name of the Participant	Mobile Number	E-mail Id	Signature
1)	Chanchal. K. Waghware	7796016894	waghwaretanu@gmail.com	Chanchal
2)	Dhanashri Newar	9859909913	Dhanashri.newar78@gmail.com	Dhanashri
3)	Riya. A. Singh	9595649831	riyaas2207@gmail.com	Riya Singh
4)	Shreyas A. Jha	8983236002	Sangeetajha@gmail.com	Shreyas
5)	Krutika S. Pakale	9021533341	pkaliskrutika@gmail.com	Krutika
6)	Aakansha. K. Khatwade	7972228707	aakanshakhatwade@gmail.com	Aakansha
7)	Aaswini S. Kulkarni	7066411418	kulkarniaswini@gmail.com	Aaswini
8)	Gunjan Bhojre	7666799586	GunjanBhojre@gmail.com	Gunjan
9)	Amisha. A. Khatwade	7666553171	amishakhatwade@gmail.com	Amisha
10)	Aakansha mairal	8070923652	aakanshamairal@gmail.com	Aakansha

Signature of:

Programme In-charge

CO-ORDINATOR

INTERNAL QUALITY ASSURANCE CELL
DHARAMPETH, M. P. DEO MEMORIAL &
SCIENCE COLLEGE, NAGPUR

Principal
PRINCIPAL

Dharampeth M.P. Deo Memorial
Science College, Nagpur-440033



DHARAMPETH M. P. DEO MEMORIAL SCIENCE COLLEGE,
North Ambazari Road, Near Ambazari Lake, Nagpur-440033

DATA VALIDATION & VERIFICATION (DVV)

11]	Lucky A Vishwakarma	9579660186	lvishwakarma@240@gmail.com	lvishwakarma
12]	Abhay P. Tembhore	897365145	abhay250102@gmail.com	Abhay
13]	Nitu B. Rai	7058638984	nitur1419@gmail.com	Nitu
14]	Kalyani R. Sindaram	8446539622	Sindaramkalanf.com	Sindaram
15]	Manthan M. Tadase	8080870430	manthan.tadase@gmail.com	Manthan

Signature of:

Programme In-charge

IQAC Coordinator
CO ORDINATOR
INTERNAL QUALITY ASSURANCE CELL
DHARAMPETH, M. P. DEO MEMORIAL &
SCIENCE COLLEGE, NAGPUR

Principal
PRINCIPAL
Dharampeth M.P. Deo Memorial
Science College, Nagpur-440033



DHARAMPETH M. P. DEO MEMORIAL SCIENCE COLLEGE,
North Ambazari Road, Near Ambazari Lake, Nagpur- 440033

DATA VALIDATION & VERIFICATION (DVV)

Name of the Programme : Aptitude Test for B.Sc. sem I students
Date of the Programme : 1st Sept - 10th Sept 2022
Name of Chief Guest if any : —
Name of Guest Speaker if any : —

Sr. No.	Name of the Participant	Mobile Number	E-mail Id	Signature
1.	Pratibha B. Bhusari	7821048413	pbhusari718@gmail.com	
2.	Shivam U. Patel	7038889083	sp040263@gmail.com	
3.	Ankit R. Patel	9970905638	ankitpatel79727@gmail.com	
4.	Ritika Bhoyar	9834587087	ritikabhoyar28@gmail.com	
5.	Neha L. Wanjari	9873832266	nehawanjari73@gmail.com	
6.	Saurabh S. Choudhary	9359883501	schaudhary5599@gmail.com	
7.	Monika I. Patel	749925468	monikapal708@gmail.com	
8.	Shital O. Patle	9764596337	sp985569@gmail.com	
9.	Yogita K. Thakre	7841024443	Yogitathakre2584@gmail.com	
10.	Karishma N. Purohit	9309318667	narendrapurohit72@gmail.com	

Signature of:

Programme In-charge

COORDINATOR
INTERNAL QUALITY ASSURANCE CELL
DHARAMPETH, M. P. DEO MEMORIAL &
SCIENCE COLLEGE, NAGPUR

PRINCIPAL
Dharampeth M.P. Deo Memorial
Science College, Nagpur-440033



DHARAMPETH M. P. DEO MEMORIAL SCIENCE COLLEGE,
North Ambazari Road, Near Ambazari Lake, Nagpur- 440033

DATA VALIDATION & VERIFICATION (DVV)

11	Shreya G. Bhim te	9637762811	shreyabhinte81@gmail.com Shreya
12)	Khineshwari R pushptode	8624976072	khineshwaripushptode@gmail.com Kh
13)	Shrutika G. Pise	9322316336	shrutikapise67@gmail.com @pise
14)	Ashwini R choudhari	9699792732	choudharaishwini281@gmail.com A.R choudhari
15)	Vaidehi Thote	7558499191	vaidhithote27@gmail.com Vaidehi
16)	Umang Warthi	9322428500	umangwarthi@gmail.com Umang
17)	Ritika Sandhiya	9175581855	ritikarsandhiya@gmail.com ritika
18)	Kastika Deshmukh	9699720960	kastikamdeshmukh@gmail.com Kastika
19)	Siddhi Tiwari	8087143696	siddhitiwari072@gmail.com Siddhi Tiwari
20)	Vaishali M. Sahare	7972925403	Vaishalisahare251@gmail.com Vaishali
21)	Muskan kulkarni	9156889239	Muskankulkarni34@gmail.com Muskan
22	Shruti channekar	9699823892	shrutichannekar200@gmail.com Shruti
23)	Chanchal. K. Waghware	7796016894	waghwanitarca@gmail.com chanchal
24)	Dhanashri Neware	9359909913	dhanashrineuare@gmail.com Dhanashri
25)	Gauri R. Bhojare	8668335876	gauranbhojare34@gmail.com Gauri
26)	Durgesh Ghodmare	9075218618	durgeshghodmare0011@gmail.com Durgesh

Signature of:

Programme In-charge

CO ORDINATOR
INTERNAL QUALITY ASSURANCE CELL
DHARAMPETH, M. P. DEO MEMORIAL &
SCIENCE COLLEGE, NAGPUR

Principal
PRINCIPAL
Dharampeth M. P. Deo Memorial
Science College, Nagpur-440033



DHARAMPETH M. P. DEO MEMORIAL SCIENCE COLLEGE,
North Ambazari Road, Near Ambazari Lake, Nagpur- 440033

DATA VALIDATION & VERIFICATION (DVV)

66)	Krutika S. Pokale	9021033341	pkalekrutika6@gmail.com	Kspokale
(27)	Manthan M. Todare	8080870430	manthantodare@gmail.com	Manthan
28)	Aakansha Y. Maital	8010923662	aakanshamaital@gmail.com	Aymaital
29)	Apeksha D. Kotangale	7559455794	apekshakotangale26@gmail.com	Akotangale
30)	Komalika S. Chaudhari	9322033866	KomalikaChaudhari07@gmail.com	Kchaudhari
31)	Anshul Y. Kirnapure	9284067169	anshulkirnapure650@gmail.com	Anshul
32)	Aparna Mohare	7020649887	aparnamohare23@gmail.com	Aparna
33)	Vaishanvi N. Jange	8421657942	Vaishulonge2004@gmail.com	Vjange
34)	Prinyanhu Raut	9322725233	prinyanhuraut56@gmail.com	Prinyanhu
35)	Nisha Pandey	8605231390	nishapandey@gmail.com	Nisha
36)	Sejal Kolhe	8483045985	sejalkolhe@gmail.com	Sejal
37)	Arya Dhoke	4011681628	aryanamrata1331@gmail.com	Arya
38)	Ravindra Khodse	8007178273	Rhodseravindra892@gmail.com	Rhodse
39)	Anjali Thakre	7066551821	thakreanjali@gmail.com	Anjali
40)	Anshul Yadav	9156494085	anshulyadav@gmail.com	Anshul
41)	Sonal G. Chaudhary	8856055003	sonalichaudhary19@gmail.com	Schaudhary
42)	Pratiksha Meshram	8419070338	Meshrampratiksha	pmeshram

Signature of:

Programme In-charge

CO-ORDINATOR
INTERNAL QUALITY ASSURANCE CELL
DHARAMPETH, M. P. DEO MEMORIAL &
SCIENCE COLLEGE, NAGPUR

PRINCIPAL

Dharampeth M. P. Deo Memorial
Science College, Nagpur-440033



DHARAMPETH M. P. DEO MEMORIAL SCIENCE COLLEGE,
North Ambazari Road, Near Ambazari Lake, Nagpur- 440033

DATA VALIDATION & VERIFICATION (DVV)

Name of the Programme : Aptitude Test for B.Sc. Sem I students
Date of the Programme : 1 septth - 10th sept 2022
Name of Chief Guest if any : —
Name of Guest Speaker if any : —

Sr. No.	Name of the Participant	Mobile Number	E-mail Id	Signature
①	Chanchal. K. Waghware	7796016894	waghwanitara@gmail.com	chanchal
(2)	Kurika S. Pokale	9091533341	pokalokurika6@punil.com	Kurika
(3)	Riya - A. Singh	9595649831	riyaas2307@gmail.com	R Singh
(4)	Shreya. A. Jha	8983236002	Sangeetajha0302@gmail.com	Shreya
(5)	Grabri R. Bhoyar	8668335876	grubjanbhoyar@gmail.com	Grabri
(6)	Ausya S. Husain	7066414418	husainausya06@gmail.com	Ahusain
(7)	Abhay P. Tembhare	8975313141	abhay230102@gmail.com	Abhay
(8)	Nitu B. Rai	7058638984	rnitu1419@gmail.com	Nitu
(9)	Dhanashree Newam	9350909913	dhanashreenewam18@gmail.com	Dhanashree
(10)	Aakansha mairal	8040823662	aakanshamairal@gmail.com	Aakansha

Signature of: [Signature]
Programme In-charge

[Signature]
CO ORDINATOR
INTERNAL QUALITY ASSURANCE CELL
DHARAMPETH, M. P. DEO MEMORIAL &
SCIENCE COLLEGE, NAGPUR

[Signature]
PRINCIPAL
Dharampeth M.P. Deo Memorial
Science College, Nagpur-440033



DHARAMPETH M. P. DEO MEMORIAL SCIENCE COLLEGE,
North Ambazari Road, Near Ambazari Lake, Nagpur-440033

DATA VALIDATION & VERIFICATION (DVV)

1) Akanksha K. Khobragade	7972228707	aakankshakhobragade7@gmail.com	Akanksha
2) Gulujan Bhojare	7666799586	GulujanBhojare@gmail.com	Gulujan
3) Anliya Hussain	7066412498	hussainanliya@gmail.com	Anliya Hussain
4) Lucky A Vishwakarma	9579660186	lvishwakarma24@gmail.com	Lucky Vishwakarma
5) Kalyani Sindram	8446539622	Sindramkalyani@gmail.com	Kalyani Sindram
6) Manthan M. Telare	8080870930	manthantelare@gmail.com	Manthan
7) Ritika R. Bhojare	984587087		Ritika
8) Samiksha Khobragade	9156906097		Samiksha
9) Kineshvari Pushptode	8624976072		Kineshvari
10) Vaishali M. Sahare	7972925403		Vaishali
11) Sonali G Choudhari	8856055003	sonalichoudhari13@gmail.com	Sonali Choudhari
12) Pratiksha Meshram	8459070338	meshrampatiksha@gmail.com	Pratiksha
13) Kitika Sondhiya	9175581655	kitikasondhiya@gmail.com	Kitika
14) Siddhi Pawar	8087143696	siddhitinwari072@gmail.com	Siddhi
15) Yogita Takare	7891024443	yogitathakare2502@gmail.com	Yogita
16) Umang G. Warthi	9322428500	umangwarthi@gmail.com	Umang

Signature of:

Programme In-charge

COORDINATOR

INTERNAL QUALITY ASSURANCE CELL
DHARAMPETH, M. P. DEO MEMORIAL &
SCIENCE COLLEGE, NAGPUR

Principal

Dharampeth M.P. Deo Memorial
Science College, Nagpur-440033



DHARAMPETH M. P. DEO MEMORIAL SCIENCE COLLEGE,
North Ambazari Road, Near Ambazari Lake, Nagpur- 440033

DATA VALIDATION & VERIFICATION (DVV)

1	Aparna Mohare	7020649887	aparnamohare23@gmail.com	Aparna
2	Arya Dhoke	9011681628	aryadhoke@gmail.com	Arya
3	Yogita Denge	7058437240	yogitadenge@gmail.com	Yogita
4	A. Priyanshu Raut	9322725233	priyanshurautesh@gmail.com	A. Priyanshu
5	Nisha Parale	8605291990	abhishek.parale.8605291990@gmail.com	Nisha
6	Arpita T. Kusum	5146162921	arpita.kusum.92@gmail.com	Arpita
7	Ravindra Khadse	8007198273	khadse.ravindra.892@gmail.com	Ravindra
8	Kalyani Sindham	8446539622	sindham.kalyani@gmail.com	Kalyani
9	Yogita Dhakare	7841024443	yogitedhakare2554@gmail.com	Yogita
10	Ashwini A. Lanjewar	9689117254	lanjewarashwini@gmail.com	Ashwini
11	Aarti Kharole	9549745628	aartikharole@gmail.com	Aarti
	Aneksha D. Kolangale			
12.	Ghanshree U. Dhokane	7774900320	dhokareghanshree@gmail.com	Ghanshree

Signature of:

Programme In-charge

CO-ORDINATOR
INTERNAL QUALITY ASSURANCE CELL
DHARAMPETH, M. P. DEO MEMORIAL &
SCIENCE COLLEGE, NAGPUR

PRINCIPAL
Dharampeth M.P. Deo Memorial
Science College, Nagpur-440033



DHARAMPETH M. P. DEO MEMORIAL SCIENCE COLLEGE,
North Ambazari Road, Near Ambazari Lake, Nagpur- 440033

DATA VALIDATION & VERIFICATION (DVV)

1	Anjali . R. Thakre	7066554821	thakreanjur281@gmail.com Anjali
2	Apeksha . D. Katangale	7559455794	apekshakatangale26@gmail.com Apeksha
3	Komalika . S. Chaudhari	9322033866	KomalikaSchaudhari073@gmail.com Komalika
4	Aasiya . S. Hussain	7066411418	Hussain's aasiya1994@gmail.com Aasiya
5	Lucky A Vishwakarma	9579660180	lvishwakarma@gmail.com Vishwakarma
6	Aakrasha . K. Khebagade	7972228707	aakrashakhebagade7@gmail.com Akasha
7	Gunjan J. Bhojar	7666799586	gunjanbhojar20@gmail.com Gunjan
8	Yachana Pandey	9156035297	yachanapandey02@gmail.com Yachana
9	Tanu T. Dhawale .	9156035297	tanudhawale@gmail.com Tanu
10	Muskan Kulkarni	9156889239	muskankulkarni06@gmail.com Muskan
11	Aarti Kharole	9579745628	kharolearti25@gmail.com Aarti
12	Ghanashree U. Dhomne	8459807047	ghanashree00@gmail.com Ghanashree
13	Amisha D. Askare	7666559171	amishaaskare07@gmail.com Amisha
14	Manthan M. Todase	808087083	todaseemanthan02@gmail.com Manthan
15	Kalyani R. Sindram	8446539622	kalyanisindram01@gmail.com Kalyani
16	Himanshi J. Kalpande	9665301444	himanshi008@gmail.com Himanshi

Signature of:

Programme In-charge

COORDINATOR
INTERNAL QUALITY ASSURANCE CELL
DHARAMPETH, M. P. DEO MEMORIAL &
SCIENCE COLLEGE, NAGPUR

REGISTRAR
Dharampeth M.P. Deo Memorial
Science College, Nagpur-440033



DHARAMPETH M. P. DEO MEMORIAL SCIENCE COLLEGE,
North Ambazari Road, Near Ambazari Lake, Nagpur-440033

DATA VALIDATION & VERIFICATION (DVV)

1.	Nitika B. Rai	7059638984	nitika1413@gmail.com	Nitika
2.	Abhay P. Tambhare	8975363145	abhay250112@gmail.com	Abhay
3.	Nihal Vishal Meshram	87677292960	nihalvishalmesh@gmail.com	N.V. Meshram
4.	Anjali Singh	8317294791	anjalisingh1505@gmail.com	Anjali
5.	Akanksha S. Togde	8605426887		Akanksha
6.	Khushi Rewade	9588445994	khushirewade02@gmail.com	Khushi Rewade
7.	Divya M. Tagde	7350090176	divyntagde@gmail.com	Tagde
8.	Neha Wanjari	9373832200	wanjarineha07@gmail.com	NWanjari
9.	Sejal D. Kolhe	8483045985	kolhesejal@gmail.com	Sejal
10.	Jeet Paudhi	7020215431	jeetpudhi@gmail.com	Jeet
11.	Nisha V. Pandey	8605231390	abhishek8605231390@gmail.com	N.Pandey
12.	Sharwari L. Umare	9284244534	sharwariumare912@gmail.com	Umare
13.	Kamolika Choudhari	9322033866	kamolikachoudhari07@gmail.com	K. Choudhari
14.	Apeksha Kotangale	7559455794	apeksha.kotangale26@gmail.com	Apeksha
15.	Anvay Anvay Borkar	9168538614	anvay16@gmail.com	A. Borkar
16.	Rashi R. Satpati	9763941509	sachisatpati77@gmail.com	Rashi

Signature of:

Programme In-charge

CO ORDINATOR
INTERNAL QUALITY ASSURANCE CELL
DHARAMPETH, M. P. DEO MEMORIAL &
SCIENCE COLLEGE, NAGPUR

PRINCIPAL

Dharampeth M.P. Deo Memorial
Science College, Nagpur-440033



DHARAMPETH M. P. DEO MEMORIAL SCIENCE COLLEGE, NAGPUR

INTERNAL QUALITY ASSURANCE CELL (IQAC)

Activity Report

Date:01/09/2022

Name of Organizing Department or Committee: Department of Physics

Name of the activity: NEP based Demonstration Activity for B.Sc. Semester III (Paper I)

Suggested CRITERION point if any: Restricted to RTMNU B.Sc. physics syllabus.

Date of Activity: 01/09/2022

Place of Activity: Room no. 004

Name of Guest Speaker/s or Judge/s or Chief Guest/s if any: NA

Title of the Activity: Demonstration of sound travel through stretched string

Activity with newspaper coverage if any: No

Number of Participants: B.Sc. Semester III Students - 50

Name of the Teacher In-charge / Convener: Dr. Nayana Sonwane

Names of other Committee Members / Staff: N.A.

OUTCOME of the Activity with respect to academics:

To know the sound travel through stretched string, sonometer instrument was used. Typically, sonometer consist of a long hollow box, AFO (Audio Frequency Oscillator), two movable bridges, a copper wire called string, and different weights. In this activity, we have demonstrated the formation of sound waves due to the resonance occurred in the string that has been attached with the load. The resonance in the string caused due to the AFO. The students witness the different parameters effecting the frequency of sound produced such as length between two bridges, tension in the string, and length per unit area of the string. They have also learned how the tension and velocity of the standing waves are related in the experiment.

DVV: Enclosed.

Activity data save in PC of: Lt. Dr. P. W. Ambekar

Prof. Pitambar Humane
IQAC Coordinator

CO ORDINATOR
INTERNAL QUALITY ASSURANCE CELL
DHARAMPETH, M. P. DEO MEMORIAL &
SCIENCE COLLEGE, NAGPUR

Name & Signature of Teacher In-charge

Dr. Akhilesh Peshwe
Principal
Principal
Dharampeth M.P. Deo Memorial
Science College, Nagpur.



DHARAMPETH M. P. DEO MEMORIAL SCIENCE COLLEGE NAGPUR

Department of Physics

Class: B.Sc. Sem.- III

NEP ACTIVITY

Paper- 1

Unit- 1

Name of the Teacher: Dr. N. Sawane

Date: 01/09/2022

Title of Activity: Demonstration of sound travel through street str

Sr. No.	Name of Student	Batch	Mobile No.	Email ID	Signature
1	Kajal Tilakdhani Prasad	S-8	7410763138	prasad2004@gmail.com	<u>KPrasad</u>
2	Mansi Ashok Bedole	S-8	7736308467	mansiabedole@gmail.com	<u>MBedole</u>
3	Shweta Ramteke	S-9	8857031895	shweta1951@gmail.com	<u>Shweta</u>
4	Kajal P. Nighat	S-8	9373250629	kajalnighat2000@gmail.com	<u>KajalNighat</u>
5	Jitendra G. Patane	S-8	965745916	Jitendra.patane@gmail.com	<u>Jitendra</u>
6	Jaasraj D. Pakhwal	S-8	9320220325	jaasrajpakhwal42@gmail.com	<u>Jaasraj</u>
7	Ritul K. Bisen	S-5	7028810840	ritulbisen06@gmail.com	<u>Ritul</u>
8	Shweta R. Bedwal	S-5	908040184	shwetabedwal2005@gmail.com	<u>Shweta</u>
9	Anuj H. Mishra	S-5	8103656208	anujmishra2020@gmail.com	<u>AnujMishra</u>
10	Atharva P. Umate	S-5	9284641511	atharva.umate@gmail.com	<u>Atharva</u>
11	Atharva Vinod Ingle	S-7	9022468036	atharvavingle@gmail.com	<u>Atharva</u>
12	Ayush B. Borilkar	S-5	9579545092	ayushborilkar55@gmail.com	<u>AyushBorilkar</u>
13	Pakshi M. Ingle	S-9	9067877694	ingloshabli203@gmail.com	<u>Pakshi</u>
14	Shraddha B. Rajee	S-10	7776804083	shraddhraje46@gmail.com	<u>Shraddha</u>
15	Mansi Sham Fading	S-8	8767134686	mansyfading2110@gmail.com	<u>MansyFading</u>
16	Aasmin K. Sheikh	S-3	8668323568	aasminsk029@gmail.com	<u>Aasmin</u>
17	Preriyanka S. Shah	S-3	7395197365	953247311@gmail.com	<u>Preriyanka</u>
18	Sanchita S. Patil	S-5	7218079074	Sanchitapatil2008@gmail.com	<u>Sanchita</u>
19	Bhagyashree S. Thakare	S-5	8766925275	bhagyashreethakare@gmail.com	<u>Bhagyashree</u>
20	Aditi Lute	S-5	7820802503	aditilute@gmail.com	<u>Aditi</u>
21	Nutansh Sanyal	S-5	8805570279	nutanshsanyal2@gmail.com	<u>Nutansh</u>
22	Ananya R. Mohapatra	S-7	8219218755	ananya.mohapatra@gmail.com	<u>Ananya</u>
23	Apurva S. Venkatar	S-7	962813911	apurva.venkatar@gmail.com	<u>Apurva</u>

2

Signature of Teacher

Head of Department
 HEAD
 DEPARTMENT OF PHYSICS
 Dharampeth M. P. Deo Memorial
 Science College, Nagpur

24)	Prakhar R. Buzardkar	S-3	83 29760853	Prakhar Buzardkar@gmail.com	<u>Prakhar</u>
25)	Kunal Digrao	S-5	8010274303	kunaldigrao@gmail.com	<u>Kunal</u>
26)	Adityakumar Shukla	S-5	9518934638	adityashukla0025@gmail.com	<u>Shukla</u>
27)	Divya Hanote	S-8	8605422901	divyahanote0406@gmail.com	<u>Hanote</u>
28)	Nitin Kushwaha	S-5	9693429005	Nitinkushwaha706@gmail.com	<u>Nitin</u>
29)	Nupur Sharma	S-8	9322042259	nupursharma258@gmail.com	<u>Nupur</u>
30)	Kavita Mishra	S-8	9657199261		<u>Kavita</u>
31)	Pradumna Singh	S-9	7666939940		
32)	Chetan Bopche	S-3	917462484625	chetanbopche@gmail.com	<u>Chetan</u>
33)	Prachit R. Koppalwar	S-9	7498102097	PrachitKoppalwar@gmail.com	<u>Prachit</u>
34)	Vrushali Shahare	S-1	9307516332	Vrushalishahare25@gmail.com	<u>Vrushali</u>
35)	Damini Kutre	S-5	8208255685	daminikutre91@gmail.com	<u>Damini</u>
36)	Bhunita V. Thakre	S-7	7219247917	Bhunitavthakre55@gmail.com	<u>Bhunita</u>
37)	Dharmapreetilale	S-7	9975037356	dharmapreetilale@gmail.com	<u>Dharmapreetilale</u>
38)	Pawan S. Vishwakarma	S-3	7058008863	PawanVishwakarma@gmail.com	<u>Pawan</u>
39)	Amkumar D. Dhangar	S-5	9763624388	ammamaji10@gmail.com	<u>Dhangar</u>
40)	Hitesh C. Kaware	S-5	7858427112	hiteshckaware73@gmail.com	<u>Kaware</u>
41)	Akshay P. Khandare	S-5	7350956809	akshaykhandare79@gmail.com	<u>Akshay</u>
42)	Harib K. G. Mishra	S-7	9067447777	Kumariganurtha mishra1010@gmail.com	<u>Mishra</u>
43)	Aditya Kumar Singh	S-7	7350543501	adityasingh288180@gmail.com	<u>Aditya</u>
44)	Dinesh Parthi	S-7	9623389674	parthidinesh51@gmail.com	<u>Parthi</u>
45)	Mithilesh Anil Prasad	S-8	7558719554	pmithilesh343@gmail.com	<u>Mithilesh</u>
46)	Ayaz M. Sheikh	S-7	8767355503	ayaz59068@gmail.com	<u>Sheikh</u>
47)	Rohit S. Warjari	S-9	7741061907	wrohit091@gmail.com	<u>Rohit</u>
48)	Pratik D. Lilhare	S-9	9307480268	Pratiklilhare3@gmail.com	<u>Pratik</u>
49)	Pratik D. Lilhare				
49)	Vaishu S. Nimje	S-9	9579993869	Vaishunimje2003@gmail.com	<u>Nimje</u>
50)	Vatan S. Sonwane	S-9	9975410765	Vatansonwane@gmail.com	<u>Vatan</u>



DHARAMPETH M. P. DEO MEMORIAL SCIENCE COLLEGE, NAGPUR
ROTARACT CLUB OF DMPDSVM
Activity Report

Date: 30 /11/2022

Name of Organizing Department or Committee: ROTARACT CLUB OF DMPDSVM

Name of the activity: Ganpati Decoration Competition

Suggested CRITERION point if any: Criterion III & Criterion V

Date of Activity: 01 September 2022

Place of Activity: College

Name of Guest Speaker/s or Judge/s or Chief Guest/s if any: NIL

Title of the Activity: Ganpati Decoration Competition

Number of Participants: 13

Name of the Teacher In-charge / Convener: Dr.Mrs.Shraddha Deshpande

Names of other Committee Members / Staff: Rotaract Club Members

OUTCOME of the Activity with respect to mission vision of the institute and or academics:

To know about the culture in the youth about Ganesh Chaturthi among new generation a platform was provided to show their skills and designing talent to make something creative. By this event under the competition they spent their time with parents and they forget for someday their digital gadgets.

Activity with newspaper coverage if any: NIL

Activity data save in PC of: Department of English

Prof. Pitambar Humane
IQAC Coordinator

CO ORDINATOR
INTERNAL QUALITY ASSURANCE CELL
DHARAMPETH, M. P. DEO MEMORIAL &
SCIENCE COLLEGE, NAGPUR

Dr. Mrs. Shraddha Deshpande
Teacher In-charge

Dr. Akhilesh Peshwe
Principal
Principal
Dharampeth M.P. Deo Memorial
Science College, Nagpur.



DHARAMPETH M.P.DEO MEMORIAL SCIENCE COLLEGE, NAGPUR

ROTARACT CLUB 22-23

Ganpati Decoration Competition

1st September 2022

Rotary.org Link:



Rotaract Club of Dharampeth M. P. Deo Memorial Science College, Nagpur
PRESENTS
Best Ganpati Decoration Competition

Chief Guest
Mrs. Priyanka Ganorkar

LAST DATE OF SUBMISSION - 3RD SEPTEMBER 2022
FIRST THREE WINNERS WILL GET PRIZES AND CERTIFICATE TO ALL

Upload your photo with
Ganpati Decoration
on the given Gmail
(Dna@rotaractdmdeom@gmail.com)

rotaract_dde **rotaractdmdeom@gmail.com** **@rotaractdhe**



DHARAMPETH M.P.DEO MEMORIAL SCIENCE COLLEGE, NAGPUR

ROTARACT CLUB 22-23

Ganpati Decoration Competition

1st September 2022

List of Students

Sr.	Name	Contact Number
1	Harsh kodape	9604677672
2	AnanyaMotghare	7219218955
3	GargiHadge	7972076671
4	Nupur Sharma	9322042259
5	PrajwalBhoyar	8010434634
6	SaniaMidhatRaza	8975726700
7	VaishnaviGadge	9022976449
8	VedantBaxy	8530455796
9	Aditi Lute	7820812303
10	RenukaLande	7719951401
11	SanchitaPatil	7218079074
12	Dhammapritilale	9975037356
13	AvishkarBansod	7820841788

Prof. Pitambar Humane
IQAC Coordinator

CO ORDINATOR
INTERNAL QUALITY ASSURANCE CELL
DHARAMPETH, M. P. DEO MEMORIAL &
SCIENCE COLLEGE, NAGPUR

Dr. Mrs. Shraddha Deshpande
Teacher In-charge

Dr. Achillesh Peshwe
Principal
Dharampeth M.P. Deo Memorial
Science College, Nagpur.



DHARAMPETH M.P. DEO MEMORIAL SCIENCE COLLEGE, NAGPUR

ROTARACT CLUB OF DMPDSVM

Activity Report

Date: 30/09/2022

Name of Organizing Department or Committee: Rotaract Club

Name of the activity: Flyer Designing Workshop

Suggested CRITERION point if any: Criterion III & Criterion V

Date of Activity: 2 September 2022

Place of Activity: College

Name of Guest Speaker/s or Judge/s or Chief Guest/s if any: Sania Raza, Renuka Lande, Aditi Lute.

Title of the Activity: Flyer designing Workshop

Number of Participants: 50

Name of the Teacher In-charge/Convener: Dr. Mrs. Shraddha Deshpande

Names of other Committee Members/ Staff: Rotaract Club Members

OUTCOME of the Activity with respect to mission vision of the institute and or academics:

Students were taught how to design and prepare flyers for various occasions through digital online and make them equip with modern techniques of online flyer making.

Activity with newspaper coverage if any: Nil

Activity data save in PC of: Department of English



Prof. Pitambar Humane

IQAC Coordinator

CO ORDINATOR

INTERNAL QUALITY ASSURANCE CELL
DHARAMPETH M.P. DEO MEMORIAL &
SCIENCE COLLEGE, NAGPUR

Dr. Mrs. Shraddha Deshpande
Teacher In-charge

Dr. Akhilesh Peshwe
Principal
Principal
Dharampeth M.P. Deo Memorial
Science College, Nagpur



DHARAMPETH M.P.DEO MEMORIAL SCIENCE COLLEGE, NAGPUR

ROTARACT CLUB 22-23

Flyer Design Workshop

2 September 2022

Rotary.org Link





DHARAMPETH M. P. DEO MEMORIAL SCIENCE COLLEGE,
North Ambazari Road, Near Ambazari Lake, Nagpur- 440033

DATA VALIDATION & VERIFICATION (DVV)

Name of the Programme : Flyer Workshop
 Date of the Programme : 2nd Sept 2022
 Name of Chief Guest if any : _____
 Co-coordinators : _____
 Name of Guest-Speaker if any : Dania Michhat Raza, Aditi Lute, Renuka Lande

Sr. No.	Name of the Participant	Mobile Number	E-mail Id	Signature
1)	Gaangi Hadge	7972076671	gaangi.hadge@gmail.com	
2)	Poojaal Bhoyari	8010434634	Poojaal6738@gmail.com	
3)	Vedant Bhatnagar	8520255746	vedantbhatnagar2002@gmail.com	
4)	Harsh Kodape	9604611612	harshkodape1008@gmail.com	
5)	Ananya R. Motghare	7219218955	ananya.r.motghare@gmail.com	
6)	Avishkar A. Banskod	7820841788	avishkarbanskod02@gmail.com	
7)	Veishnav. V. Gadge	9022976449	gadgaveishnav00@gmail.com	
8)	SAHIL SINGH	7258868502	sahilsingh06@gmail.com	
9)	Harshadwarthi	7414993575	harshadwarthi9572@gmail.com	
10)	Simran Ahimale	7666330683	simranahimale20@gmail.com	

Signature of:

 Programme In-charge

CO-ORDINATOR
 IQAC Coordinator
 INTERNAL QUALITY ASSURANCE CELL
 DHARAMPETH, M. P. DEO MEMORIAL
 SCIENCE COLLEGE, NAGPUR

Principal
 Dharampeth M.P. Deo Memorial
 Science College, Nagpur.



DHARAMPETH M. P. DEO MEMORIAL SCIENCE COLLEGE,
North Ambazari Road, Near Ambazari Lake, Nagpur- 440033

DATA VALIDATION & VERIFICATION (DVV)

11)	Larisa Midhat Raja	89757268700	midhatlarisa@gmail.com	Alap
12)	Nikita Barapatre	7058629053	pvachibaratre@gmail.com	Barapatre
13)	Ashlesha Sangale	9503998469	Ashlesha Sangale 94@	Sangale
14)	Nupur. M. Sharma	9822042259	nupursharma258@gmail.com	Sharma
15)	Veena Borikar	9322016921	veenaborikar14@gmail.com	Veena
16)	Sakshi Mishra	9158788969	smishra939683@gmail.com	S. Mishra
17)	Varsha Turkar	9373650950	varshaturkar23@gmail.com	Turkar
18)	Janhvi Joge	7385060971	JanhviJoge08@gmail.com	Janje
19)	Janhvi Jaibey	8446510539	JanhviJaibey@gmail.com	Jaibey
20)	Pradnya Tripathi	8010362232	pradnyatripathi9145@gmail.com	Pradnya
21)	Mohit Khindkar	8055328357	mohitkhindkar@gmail.com	Mohitkar
22)	Mahima Klane	9545918778	medimalclane11@gmail.com	Klane
23)	Pratishtha Bawre	9579836818	Pratishthabawre49@gmail.com	Pratishthabawre
24)	Mulkar Veerdye	9809773287	mulkarveerdye9@gmail.com	Veerdye
25)	Rutika Yadav	8446085943	yadavrutika0434@gmail.com	Yadav

Signature of:

Programme In-charge

CO-ORDINATOR
INTERNAL QUALITY ASSURANCE CELL
DHARAMPETH, M. P. DEO MEMORIAL &
SCIENCE COLLEGE, NAGPUR

Principal
Dharampeth M.P. Deo Memorial
Science College, Nagpur.



DHARAMPETH M. P. DEO MEMORIAL SCIENCE COLLEGE,
North Ambazari Road, Near Ambazari Lake, Nagpur- 440033

DATA VALIDATION & VERIFICATION (DVV)

26	Sonia Niwal	7088425021	niwalsonia70@gmail.com Sonia
27	Devashai kerkale	9021344265	devashaikerkale@gmail.com D.P. kerkale
28	Geet Gendhal Makhade	9112142728	Mihil makhade@gmail.com Geet
29)	Manu Poo	7350480579	manu7350450@gmail.com Manu
36)	Vibhanshu Taire	9561232204	Vibhanshutaire7@gmail.com Vibhanshu
37)	Kartik Misra	9604792402	Kartikmisra054@gmail.com Kartik
38	Priyanshu Singh	9527710380	priyanshusingh0012@gmail.com P. Singh
39)	Rahul - Pandey	8767788703	rp9356521@gmail.com Rahul Pandey
40)	Tejas Dongre	9322578918	Tej9874k@gmail.com Tejas
41)	Tushal - R. Achare	9075995617	achare.tushal@gmail.com Tushal
42)	Vedant O. Unsethkar	9049932753	unsethkarvedd@gmail.com Vedant
43)	Badal G. Sonkumar	7448247150	badalsonkumar@gmail.com Badal
44)	Mahesh D. Pande	9112875119	pandemahesh93@gmail.com Mahesh
45)	Isha Waghmare	8855919474	ishawaghmare9474@gmail.com Isha
46)	Prachi Pardihi	9263935912	prachipardihi82@gmail.com Prachi

Signature of:

Programme In-charge

CO-ORDINATOR
INTERNAL QUALITY ASSURANCE CELL
DHARAMPETH, M. P. DEO MEMORIAL &
SCIENCE COLLEGE, NAGPUR

Principal
Dharampeth M.P. Deo Memorial
Science College, Nagpur.



DHARAMPETH M. P. DEO MEMORIAL SCIENCE COLLEGE,
North Ambazari Road, Near Ambazari Lake, Nagpur- 440033

DATA VALIDATION & VERIFICATION (DVV)

47)	Bhagyashali D. Alewase	7796434177	sakshinewase2017@gmail.com B.D.alewase
48)	Samiksha A. Panchbudhe	9763075890	Samikshapanchbudhe@gmail.com S.Panchbudhe
49)	Kavita Mishra	9657199261	km7832888@gmail.com Kavita
50	Divya Hanote	8605422901	divyahanote@gmail.com Dhanote

Signature of:

Programme In-charge

CO ORDINATOR
INTERNAL QUALITY ASSURANCE CELL
DHARAMPETH, M. P. DEO MEMORIAL &
SCIENCE COLLEGE, NAGPUR

Principal
Dharampeth M.P. Deo Memorial
Science College, Nagpur.



DHARAMPETH M. P. DEO MEMORIAL SCIENCE COLLEGE, NAGPUR

INTERNAL QUALITY ASSURANCE CELL (IQAC)

Activity Report

Date: 3rd September 2022

Name of Organizing Department or Committee: Electronics Department

Name of the Activity : Study of Multimeter and Breadboard(NEP)

Suggested CRITERION point if any: Suggested criteria II

Date of Activity: 3rd September 2022

Place of Activity : Electronics Lab

Name of Guest Speaker/s or Judge/s or Chief Guest/s if any : Not applicable

Title of the Activity: Study of Multimeter and Breadboard

Based on Unit : 2(Paper I)

Class : Semester I

Number of Participants: 14

Name of the Teacher In-charge / Convener: Mrs. Leena P. Thakare

OUTCOME of the Activity with respect to mission vision of the institute and or academics:

Students learn about the function, working and application of Multimeter. They also learn how to use the breadboard for making the circuits.

Prof. Varsha V. Rangari

Head of the Department



Prof. Pitambar Humane

IQAC Coordinator

CO ORDINATOR

**INTERNAL QUALITY ASSURANCE CELL
DHARAMPETH, M. P. DEO MEMORIAL &
SCIENCE COLLEGE, NAGPUR**

Dr. Akhilesh Peshwe

Principal
Dharampeth M.P. Deo Memorial
Science College, Nagpur.



Dharampeth M. P. Deo Memorial Science College,
Nagpur

Electronics Department
Semester I - (2022-23)

Activity 1
Based on Paper I -Unit 1

Date: 03/09/2022

Activity: Study of Multimeter and Breadboard.

Objective:

- To make the students aware about the function, working and application of Multimeter.
- To know the use of Breadboard.

Sr. No.	Students Name	Signature
1.	TANU . HJAY . SINGH	Tanu
2.	Simran N. Dhimale	Simran
3.]	TUSHAL .R. ACHARE	Tushal
4.	Beckant D. Umethkar	Beckant
5.	Ved .S. Choudhary	Ved
6.	Bhagyashali D. Neware	B.D. Neware
7.	Khushi .R. Ali	Khushi
8.	Kashish Bisen	K. Bisen
9.	Khushbu Pali	Khushbu
10.	Aayushi Singh	Ayushi
11.	Vaidhvee .B. Gangekar	Vaidhvee
12.	Tejash Dongre	Tejash
13.]	Pranishu Singh	Pranishu
14.]	Vineet .Mukesh. Singh	Vineet

Dr. Prakash



DHARAMPETH M. P. DEO MEMORIAL SCIENCE COLLEGE, NAGPUR

Department of Electronics

Semester I - (2022-23)

Activity (Paper I - Unit- 2)

Sr. No.	Student Name	Mobile Number	Email ID
1	Tanu Ajay Singh	8806355808	tanusingh63492@gmail.com
2	Simran Narendra Dhimole	8390347026	mishralaxmi210@gmail.com
3	Khushbu Rajiv Pali	8459565214	palikhushbu59@gmail.com
4	Aayushi Vikram Singh	9595119942	senxerox04@gmail.com
5	Tushal Rupkumar Achare	9075995617	acharetushal5@gmail.com
6	Vedant Onkar Umretkar	9049932753	umretkarvedant@gmail.com
7	Khushi Rajiv Pali	8767607224	palikhushi4@gmail.com
8	Kashish Kamalkumar Bisen	7887886117	kashishbisen05@gmail.com
9	Ved Sudhir Choudhary	7498572766	vedchoudhary.cs.749@gmail.com
10	Aniket Jayram Bawankar	9322804484	adityabawankar9@gmail.com
11	Tejas Ramesh Dongre	9322578918	tejasdongre453@gmail.com
12	Vaidhavi Baburao Gongal	7507907278	gayatrigongal787@gmail.com
13	Bhagyashali Dadarao Neware	7796434177	sakshineware2017@gmail.com
14	Vineet Mukesh Singh	9766035354	vineetsingh3533@gmail.com

Pitambar Humane
Name & Signature of Teacher In-Charge

Pitambar Humane
Prof. Pitambar Humane
IQAC Coordinator

CO ORDINATOR
INTERNAL QUALITY ASSURANCE CELL
DHARAMPETH, M. P. DEO MEMORIAL &
SCIENCE COLLEGE, NAGPUR

Dr. Varsha V. Rongari
Name & Signature of Head of the
Department

Dr. Varsha V. Rongari
Professor & Head
Department of Ele.
Dharampeth M.P. Deo
Science College, Nagpur

Dr. Akhilesh Peshwe
Principal
Principal
Dharampeth M.P. Deo Memorial
Science College, Nagpur.



DHARAMPETH M. P. DEO MEMORIAL SCIENCE COLLEGE, NAGPUR
INTERNAL QUALITY ASSURANCE CELL (IQAC)

Activity Report

Date: 05/09/2022

Name of Organizing Department or Committee: Microbiology Department

Name of the activity: Poster making Activity on Microscopy and Staining Techniques

Suggested CRITERION point if any: Criterion II and V

Date of Activity: 24/08/2022

Place of Activity: Microbiology Laboratory

Name of Guest Speaker/s or Judge/s or Chief Guest/s if any: Guest Speaker- Nil

Title of the Activity:

Number of Participants: 26

Name of the Teacher In-charge / Convener: Dr. Vaishali Pimple

Names of other Committee Members / Staff:

OUTCOME of the Activity with respect to mission vision of the institute and or academics: 1. Students understood the different parts of Compound Microscopes and their functions. 2. Students understood the difference between Gram + & Gram - ve bacteria.



Vaishali Pimple
Dr. Vaishali Pimple
Name & Signature of Teacher In-charge

Pitambar Humane
Prof. Pitambar Humane
IQAC Coordinator

CO ORDINATOR
INTERNAL QUALITY ASSURANCE CELL
DHARAMPETH, M. P. DEO MEMORIAL &
SCIENCE COLLEGE, NAGPUR

Dr. Akhilesh Peshwe
Principal
Dharampeth M.P. Deo Memorial
Science College, Nagpur.



DHARAMPETH M. P. DEO MEMORIAL SCIENCE COLLEGE,
North Ambazari Road, Near Ambazari Lake, Nagpur- 440033

DATA VALIDATION & VERIFICATION (DVV)

Name of the Programme : Poster Making of charts on Microscopy and charts of staining of Bacteria
Date of the Programme : 5/9/22
Name of Chief Guest if any : Nil
Name of Guest Speaker if any : Nil

Sr. No.	Name of the Participant	Mobile Number	E-mail Id	Signature
1	Dally K. Wanjari	9926013213	kishanwanjari12945@gmail.com	Dally
2	Aparna Mohare	7020649857	aparnamohare23@gmail.com	Aparna
3	Nity B. Rai	7058618984	onitru1419@gmail.com	Nity
4	Ravindra Khadse	8007198273	khadse.ravindra892@gmail.com	Ravi
5	Arya Dhoke	9011681678	aryanamsate1331@gmail.com	Arya
6	Yogita Denge	7056437240	yogitadenge@gmail.com	Yogita
7	Neha Wanjari	9373832266	nehawanjari733@gmail.com	Neha
8	Pranali Chauhan	9699654562	pranalic Chauhan69@gmail.com	Pranali
9	Shravani Umare	9284249534	shravaniumare1912@gmail.com	Shravani
10	Komalika Chaudhari	9322033866	Komalika Chaudhari@gmail.com	Komalika

Signature of:

Programme In-charge

IQAC Coordinator

Principal
Dharampeth M. P. Deo Memorial
Science College, Nagpur.



DHARAMPETH M. P. DEO MEMORIAL SCIENCE COLLEGE,
North Ambazari Road, Near Ambazari Lake, Nagpur- 440033

DATA VALIDATION & VERIFICATION (DVV)

11	Vaishnavi Tonge	8421657943	Vaishnavitonge@gmail.com - vaishnavi
12	Krutika Pokale	9021533541	pokalekrutika6@gmail.com, krutika
13	Litauzi R. Bhojare	8668335876	gungabhojare30@gmail.com - G.ang
14	Chanchal K. Waghware	7796016894	waghwarechanchal@gmail.com - chanchal
15	Aakansha Y. Mavral	8010923662	aakanshayogi2000@gmail.com - Aakansha
16	Dhanashri Neware	9009009713	dhanashrineware100@gmail.com - Dhanashri
17	Anvay Borkare	9168538619	borkareanvay@gmail.com - Anvay
18	Meenal Chaudhary	9529024604	meenachaudhary@gmail.com - Meenal
19	Shreyo A. Jha	8983236002	Sangeetajha0303@gmail.com - Shreyo
20	Riya A. Singh	9595649831	riya032307@gmail.com - Riya
21	Anshul Kishnapure	9284067169	anshulkishnapure650@gmail.com - Anshul
22	Anjali Thakre	7060549821	anjaliithakre@gmail.com - Anjali
	Apeksha Katungle	7559455794	apekshakatungle@gmail.com - Apeksha

Signature of:

Programme In-charge

CO ORDINATOR
INTERNAL QUALITY ASSURANCE
DHARAMPETH, M. P. DEO MEMORIAL &
SCIENCE COLLEGE, NAGPUR
IQAC Coordinator

Principal
Dharampeth M.P. Deo Memorial
Science College
Principal



DHARAMPETH M. P. DEO MEMORIAL SCIENCE COLLEGE,
North Ambazari Road, Near Ambazari Lake, Nagpur- 440033

DATA VALIDATION & VERIFICATION (DW)

26	Urmang G. Wadhvani	9322428500	urmang.wadhvani@gmail.com	<i>[Signature]</i>
27	Muskan Kulkarni	1956889239	muskan.kulkarni@gmail.com	<i>[Signature]</i>
28	Vaidehi Thote	7558499191	vaidehi.thote27@gmail.com	<i>[Signature]</i>

Signature of:

Programme in-charge

IQAC Coordinator

Principal



DHARAMPETH M. P. DEO MEMORIAL SCIENCE COLLEGE, NAGPUR
INTERNAL QUALITY ASSURANCE CELL (IQAC)

Activity Report (NEP)

Date: 23rd Nov. 2022

Name of Organizing Department or Committee: Home Science

Name of the activity: Pictorial Presentation on areas of
Development in the form of Activity Book

Suggested CRITERION point if any:

Date of Activity: 5.9.22

Place of Activity: Home Science Department

Name of Guest Speaker/s or Judge/s or Chief Guest/s if any: NA

Title of the Activity: Activity on preparation of
Activity Book

Number of Participants: 17

Name of the Teacher In-charge/Convener: Mrs M M Deshpande

Names of other Committee Members/Staff:

OUTCOME of the Activity with respect to mission/vision of the institute and/or academics: Variety in
instructional teaching

Students prepare & enlist activities of different areas of development & paste it in form of
Activity Book

Learn the Concepts clearly by making the Activity Book

Activity with newspaper coverage if any: NA

Activity data save in PC of:

Prof. Pitambar Humane
IQAC COORDINATOR
INTERNAL QUALITY ASSURANCE CELL
DHARAMPETH, M. P. DEO MEMORIAL &
SCIENCE COLLEGE, NAGPUR

Name & Signature of Teacher In-charge

Dr. Akhilesh Peshwe
Principal
DHARAMPETH M. P. DEO
MEMORIAL SCIENCE COLLEGE

Date: - 22/11/2022



DHARAMPETH M. P. DEO MEMORIAL SCIENCE COLLEGE,
North Ambazari Road, Near Ambazari Lake, Nagpur- 440033

DATA VALIDATION & VERIFICATION (DVV)

Srno	Name	Mobile no.	email.	Sign
1)	Kimaya N. Kale	8866073792	kimayakale003@gmail.com	Kimaya
2)	Bhaskar G. Havane	7057791359	Bhaskarhavane@gmail.com	Bhaskar
3)	Avani S. Shenwai	9096507459	Avanishenwai152@gmail.com	Ashenwai
4)	Tannu S. Korde	7841984450	Kordetannu139@gmail.com	TKorde
5)	jasvi M. Wankhede	8767699751	wankhedejasvi@gmail.com	Jasvi
6)	Priya K. Khawshi	9763617224	priyakhawshi3@gmail.com	Priya
7)	Mansi . N. Chaudhary	7720088783	chaudharymanshi92@gmail.com	Mansi
8)	Riya . N. Mafly	7350980367	maflynur23@gmail.com	Rimafly
9)	Pranali H. Ghongardkar	9309079427	Pranali09gh@gmail.com	Pranali
10)	Sujata V. Katre	9175451202	Sujatakatre9@gmail.com	SKatre
11)	Pallavi B. Katre	8459277408	Pkatre573@gmail.com	Pallavi
12)	Shrushti S. Patkar	7381067403	Shrushtipatkar@gmail.com	Shrushti
13)	Bhagyashree S. Ambule	9359139068	ambuleb67@gmail.com	Bambule
14)	Nisha A. Chormare	8669586501	nishachormare5@gmail.com	Nisham
15)	Prajakta A. Wakde	8459413596	prajaktawakde2004@gmail.com	Pawakde

Signature of:

Programme In-charge

IQAC Coordinator

CO ORDINATOR

INTERNAL QUALITY ASSURANCE CELL
DHARAMPETH, M. P. DEO MEMORIAL
SCIENCE COLLEGE, NAGPUR

Principal

Dharampeth M.P. Deo Memorial
Science College Nagpur



DHARAMPETH M. P. DEO MEMORIAL SCIENCE COLLEGE, NAGPUR
INTERNAL QUALITY ASSURANCE CELL (IQAC)
Activity Report (2022-23): National Cadet Corps

Date: 31/12/2022

Name of Organizing Department or Committee: National Cadet Corps

Name of the activity: Report on NCC activities associated with ZMAH ARMD SQN NCC Nagpur

Suggested CRITERION point if any: 5.3

Date of Activity: Year Round

Place of Activity: ZMAH ARMD SQN NCC, 66 VCA, Civil Lines, Nagpur and at Dharampeth M. P. Deo Memorial Science College, Nagpur

Name of Guest Speaker/s or Judge/s or Chief Guest/s if any: The Officer Commanding & Staff members of the NCC unit along with ANO, Lt. Dr. Prashant W. Ambekar

Title of the Activity: NCC Related activities

Number of Participants: The enrolled cadet's number of unit (190-200), College (40)

Name of the Teacher In-charge / Convener: Lt. Dr. Prashant Ambekar

Names of other Committee Members / Staff: NA

OUTCOME of the Activity with respect to mission vision of the institute and or academics:

NCC Unit, ZMAH ARMD SQN, NCC, Civil Lines, Nagpur, allotted 13 SD cadets as intake to a NCC senior division first year for the current session in addition to the second year and third year cadets. In addition, 4 cadets were enrolled with Air Wing, Navel Btn, Eng. Coy and Medical Coy etc. units. Thus, a good number of 17 cadets are enrolled this year to NCC first year in addition to the second- and third-year cadets.

Apart from the compulsory Drill, Weapon Training, Map Reading and Personality/ Leadership Qualities Development in special classes, National level camps were conducted at unit location. Our cadets were performing well in all fronts. Cadets were honoured with ranks and promoted to higher ranks too. The names of cadets are as follows-

1. SUD Poonam Chouraghade
2. SGT Nimish Navghare, II year
3. SGT Samiksha Tabhane
4. CPL Bhumika Chedge
5. CPL Sahil Ghodeswar
6. CDT Supriya Patle played University level in Kabaddi and Kho-Kho

RDC practice were undertaken and few cadets were selected at the entry level Pre-RD Camp too. Apart from the regular CAT camp, cadets have been participated TSC, Pre-RDC, and other camps. In CATC-611 during 06-14 September 2022.

Apart from these activities Lt. Dr. P. W. Ambekar also conducted few activities in the Campus of the college and NCC Unit as given below-

-HEAD
DEPARTMENT OF PHYSICS
Dharampeth M. P. Deo Memorial
Science College, Nagpur

1. Conducted Independence Day and Republic Day activities in the college where in most of the NCC cadets were present, They performed drills and other NCC activities.
2. NCC selection for first year enrolment on 04-08-2022.



Subjects such as Personality Development Capsule, Environmental awareness and water & energy conservation, Leadership Development Capsule, Health and Hygiene, etc.

Activity with newspaper coverage if any: NA

Activity data save in PC of: Lt. Dr. P. W. Ambekar



Prof. Pitambar Humane
 IQAC Coordinator
 CO ORDINATOR
 INTERNAL QUALITY ASSURANCE CELL
 DHARAMPETH, M. P. DEO MEMORIAL &
 SCIENCE COLLEGE, NAGPUR

HEAD
 Lt. Dr. P. W. Ambekar
 Name & Signature of Head
 Dharampeth M. P. Deo Memorial
 Science College, Nagpur

PRINCIPAL
 Dr. Akhilesh Peshwe
 Dharampeth M. P. Deo Memorial
 Science College, Nagpur.

DHARAMPETH M. P. DEO MEMORIAL SCIENCE COLLEGE, NAGPUR

Near Ambazari Lake, North Ambazari Road, Nagpur- 440033

NATIONAL CADET CORPS (NCC)

2MAH ARMD SQN NCC, 66-VCA Stadium, Civil Lines, Nagpur- 440001

NOTICE

All the admitted students in First Semester of B. Sc. Course in the current session are hereby informed that our College is associated with an Open NCC unit mentioned above. Those students who are interested to enroll for the NCC from this year, should join the WhatsApp group by scanning the QR code provided below. This group is a provisional group till the enrollment process is complete. The enrollment process will be explained on the said group in due course of time. For any assistance you can contact the senior NCC cadets which are already added in the group.



NCC-DSC (2022)

WhatsApp group



(Lt. Associate NCC Officer
Dharampeth M. P. Deo Memorial
Science College)

2MAH ARMD SQN NCC, Civil Lines, Nagpur

Email: pacific0701@rediffmail.com

Mobile: 7776899668

DHARAMPETH SCIENCE COLLEGE 2nd YEAR : SD/SW TRG YEAR 2022-23

S. No	Regt No	Rk	Name	DOB	Mobile No	Aug 22		Sep 22		Oct 22		Nov 22		Dec 22		Jan 23		Feb 23																			
						06	13	20	27	04	11	18	25	01	08	15	22	29	05	12	19	26	03	10	17	24	31	07	14	21	28	04	11	18	25		
1.	818528	CDT	Aditya Singh	08/06/2003	8999323042	P	P	P	P	P	P	P	P	P	P	P	P	P	P	P	P	P	P	P	P	P	P	P	P	P	P	P	P	P	P	P	P
2.	818529	CDT	Pratik Lihare	31/12/2002	9307480168	.	P	P	P	P	P	P	P	P	P	P	P	P	P	P	P	P	P	P	P	P	P	P	P	P	P	P	P	P	P	P	P
3.	818530	CDT	Anuj Mishra	25/12/2002	8103656208	P	P	P	P	P	P	P	P	P	P	P	P	P	P	P	P	P	P	P	P	P	P	P	P	P	P	P	P	P	P	P	P
4.	818532	CDT	Shreyash Chatte	21/04/2003	8446364089	P	P	P	P	P	P	P	P	P	P	P	P	P	P	P	P	P	P	P	P	P	P	P	P	P	P	P	P	P	P	P	P
5.	818533	CDT	Pradumna Singh	24/12/2001	7666939940	P	P	P	P	P	P	P	P	P	P	P	P	P	P	P	P	P	P	P	P	P	P	P	P	P	P	P	P	P	P	P	P
6.	818537	CDT	Rohit Wanjari	18/04/2004	7741061907	.	P	P	P	P	P	P	P	P	P	P	P	P	P	P	P	P	P	P	P	P	P	P	P	P	P	P	P	P	P	P	P
7.	818538	CDT	Vatan Sonwane	16/07/2002	9975410765	P	P	P	P	P	P	P	P	P	P	P	P	P	P	P	P	P	P	P	P	P	P	P	P	P	P	P	P	P	P	P	P
8.	818539	CDT	Sudhanshu Ulkey	22/11/2002	7028429173	P	P	P	P	P	P	P	P	P	P	P	P	P	P	P	P	P	P	P	P	P	P	P	P	P	P	P	P	P	P	P	P
9.	818540	CDT	Prachit Kotpalliwar	25/10/2003	7498102097	P	P	P	P	P	P	P	P	P	P	P	P	P	P	P	P	P	P	P	P	P	P	P	P	P	P	P	P	P	P	P	P
10.	818541	SGT	Nimish Nawghare	21/09/2003	9689878735	P	P	P	P	P	P	P	P	P	P	P	P	P	P	P	P	P	P	P	P	P	P	P	P	P	P	P	P	P	P	P	P

(Signature)
 Associate NCC Officer
 Dharampeth M. P. Doo Memorial
 Science College, Nagpur

DHARAMPETH SCIENCE COLLEGE 3rd YEAR : SD/SW TRG YEAR 2022-23

S. No	Regt No	Rk	Name	DOB	Mobile No	Aug 22				Sep 22				Oct 22				Nov 22				Dec 22				Jan 23				Feb 23																						
						06	13	20	27	3	10	17	24	01	08	15	22	29	05	12	19	26	03	10	17	24	31	07	14	21	28	4	11	18	25																	
1.	818436	CDT	Abhijeet Mankar	21/06/2002	8788049642	P	P	.	P	P	P	P	P	.	P	P	.	P	P	P	P	P	.	P	P	P	P	P	.	P	P	P	P	.	P	P	P	P	P	.	P	P	P	P	P	.	P	P	P	P	P	.
2.	818437	CDT	Pintu Ojha	14/10/2001	7066757753	P	.	P	P	P	P	P	P	.	P	P	P	P	P	P	P	P	.	P	P	P	P	P	.	P	P	P	P	P	.	P	P	P	P	P	.	P	P	P	P	P	.					
3.	818438	CDT	Rajesh Khandaikara	25/04/2002	9096660328	P	.	P	P	P	P	P	P	.	P	P	P	P	P	P	P	P	.	P	P	P	P	P	.	P	P	P	P	P	.	P	P	P	P	P	.	P	P	P	P	P	.					
4.	818439	CDT	Snehal Bute	18/06/2003	9284476408	P	P	.	P	P	P	P	P	.	P	P	P	P	P	P	P	P	.	P	P	P	P	P	.	P	P	P	P	P	.	P	P	P	P	P	.	P	P	P	P	P	.					
5.	818440	CDT	Sahil Ghodeswar	30/05/2003	7507999271	.	P	P	P	P	P	P	P	.	P	P	P	P	P	P	P	P	.	P	P	P	P	P	.	P	P	P	P	P	.	P	P	P	P	P	.	P	P	P	P	P	.					
6.	818464	SUO	Poonam Chauragade	01/07/2002	8767765121	P	P	P	P	.	P	P	P	P	.	P	P	P	P	P	P	P	.	P	P	P	P	P	.	P	P	P	P	P	.	P	P	P	P	P	.	P	P	P	P	P	.					
7.	818465	CDT	Supriya Patle	19/09/2002	7757871925	.	P	P	P	P	.	P	P	P	P	.	P	P	P	P	P	P	.	P	P	P	P	P	.	P	P	P	P	P	.	P	P	P	P	P	.	P	P	P	P	P	.					
8.	818466	SGT	Samiksha Tabhane	22/04/2001	9307133863	P	P	P	P	.	P	P	P	P	.	P	P	P	P	P	P	P	.	P	P	P	P	P	.	P	P	P	P	P	.	P	P	P	P	P	.	P	P	P	P	P	.					
9.	818467	CPL	Bhumika Chedge	27/02/2003	8830391103	P	P	.	P	P	P	P	P	.	P	P	P	P	P	P	P	P	.	P	P	P	P	P	.	P	P	P	P	P	.	P	P	P	P	P	.	P	P	P	P	P	.					
10.	818468	CDT	Prachi Waghale	11/09/2002	8767914118	P	P	P	P	.	P	P	P	P	.	P	P	P	P	P	P	P	.	P	P	P	P	P	.	P	P	P	P	P	.	P	P	P	P	P	.	P	P	P	P	P	.					

VB



DHARAMPETH M. P. DEO MEMORIAL SCIENCE COLLEGE NAGPUR
2MAH ARMD SQN NCC, CIVIL LINES, NAGPUR



Office: 0712-22241372
Mobile: +91-9423628492
Email: pacific0701@rediffmail.com

Lt. Dr. P. W. AMBEKAR
ANO & Asst. Professor
Department of Physics

Date:22.07.2022

NOTICE

All the first year students (both girls and boys) willing to join the NCC during current session (2022-23) are hereby informed that their college level NCC selection procedure will be carried on July,27 ,2022 (Wednesday) at college sports at 7:00 am sharply.

After successful performance the selected candidates will be sent for the final selection at NCC unit (2MAH ARMD SQN NCC, VCA Building, Civil Lines, Nagpur) which is scheduled on July,30,2022 (Saturday) (7.00 am sharp). Unit Phone No. 0712-2560810.

All candidates must understand that ,It is mandatory to attend the regular parades failing which, their enrolment may be canceled and the vacancies will be allotted to other needy students, please take a serious note of this.

All the senior NCC (II and III year) cadets (SD and SW) are hereby informed that they should remain present during the selection process of of first year students on both days.

Associate NCC Officer

(Lt. Dr. P. W. Ambekar)
Associate NCC Officer
Dharampeth M. P. Deo Memorial
Science College, Nagpur



Activity Report

Date: 30.9.22

Name of Organizing Department or Committee: Home Science Department

Name of the activity: Event Management of Running a One Day Canteen Activity & Celebration of National Nutrition Month

Suggested CRITERION point if any:

Date of Activity: 6.09.2022 at 12 Noon

Place of Activity: Near College Canteen

Name of Guest Speaker/s or Judge/s or Chief Guest/s if any: Mrs. Pradnya Bagalkote

Title of the Activity: Event Management

Number of Participants: Total 18 students of Semester 5th

Name of the Teacher In-charge / Convener: Ms. Ankita Wankhede

Names of other Committee Members / Staff: Mrs. Meghna Pandit, Dr. Ashwini Meshram, Miss. Pranali Bathe, Mrs. Meghna Pandit

OUTCOME of the Activity with respect to mission vision of the institute and or academics:

1. This activity builds confidence in students to start up their own small canteen/ cafe. They will be able to manage such event well in coming future.
2. Students learn and develop new recipes which is high nutritious way.
3. From this activity students learn strategies planning, organising of resources, implementation of plan, and what effective decision done during the activity.
4. Also critical evaluation how they have used management skills.
5. Learn Marketing Skill.

Activity with newspaper coverage if any:

Activity data save in PC of: Home Science Staff Room Desktop

Note: Kindly share geotag photographs separately along with report on iqacdsc2022@gmail.com



CO ORDINATOR
INTERNAL QUALITY ASSURANCE CELL
DHARAMPETH, M. P. DEO MEMORIAL &
SCIENCE COLLEGE

Name & Signature of Teacher In-charge

PRINCIPAL
Principal Dharampeth M. P. Deo Memorial
Science College, Nagpur

To,

The Principal,

Dharampeth M.P. Deo Memorial

Science College Nagpur.

Date :- 3/09/2022

Subject:- Permission for conducting one day activity Event Management- of running a canteen under Family Resource Management, as mention in syllabus and PoshanMaah (National Nutrition Month) which we celebrate in the month of September.

Respected Sir,

Requesting wide this letter to grant us permission to conduct this event which is mention in the syllabus for Semester V and VI students of B.Sc Home Science. The program will be held on 6th Sept in our college canteen. All the consideration as per directed will be taken care of. Declaration letter would be signed by every student in advance. Name of the following teachers deputed for this task are Miss. AnkitaWankhede, Miss Pranali Bathe and PradnyaBagalkote.

Hope you will grant us permission for the same.

Thanking you in anticipation

Yours sincerely

Ms. Manju Deshpande 2.09.22

HOD of Home Science Department

PRINCIPAL
Dharampeth M.P. Deo Memorial
Science College Nagpur-440033

Event Management of Running a One Day Canteen

CHIWADA TESTING ACTIVITY 15/03/2022

Celebration of NNM 2022

NAME OF LECTURER - Mrs. Pradhya M. Bagalliate

DATE 6/9/2022

Sr no	Colour	TEXTURE	TASTE	APPEARANCE	CRISPNESS	TOTAL
Apple.	8	8	10	10	10	46
Veg. Cutlet	10	10	10	10	10	50 ← Winner
corn chat.	8	8	8	8	8	40

Pradhya M. Bagalliate
6/9/2022

Score sheet Submitted
after Judging the Event.

One Day Canteen Activity
6/9/2022



DHARAMPETH M. P. DEO MEMORIAL SCIENCE COLLEGE,
North Ambazari Road, Near Ambazari Lake, Nagpur- 440033

DATA VALIDATION & VERIFICATION (DVV) final year (5th sem)

1.	Riya Sherekar	7249070278	sherekar04@gmail.com	R Sherekar
2.	Pooja S. Chute	9552381386	bestmichute123@gmail.com	Pooja
3.	Mahima R. Wankhede	7821883251	mahima01wankhede@gmail.com	Mahima
4.	Sushmita Mallick	9837916560	sushmitta76@gmail.com	Sushmita
5.	Vaishnavi Bahadure	9284679244	vaishnavibahadure21@gmail.com	Vaishna
6.	Pranali G. Raut	9130117015	Pranaliraute567@gmail.com	Pranali
7.	Sakshi. S. Thosar	8177911360	sakshithosar620@gmail.com	Sakshi
8.	Aarti A. Raut	8625813189	araut@12345.com	ARaut
9.	Varnika A. Redase	7448118928	varnikaar@gmail.com	Varnika
10.	Vaishnavi Upasak	9975287481	upasakvaishnavi@gmail.com	Vaishnavi
11.	Payal. C. Chhumatkar	9067560926		P.C. Chhumatkar
12.	Renuka. D. Raut	8855972285	rautrenuka88@gmail.com	RRaut
13.	Mayuri. G. Mali	9067028172	Mayuri Mali 182003@gmail.com	Malini
14.	Aashi. P. Ramteke.	8983345716	aashiramteke7@gmail.com	Ramteko
15.	Ananya A. Meghree	9284834439	ananyaMeghree@gmail.com	AMeghree

Signature of:

Ankita Wankhede

Programme In-charge

Ms. Ankita Wankhede

Anant

CO-ORDINATOR

INTERNAL QUALITY ASSURANCE CELL
DHARAMPETH, M. P. DEO MEMORIAL &
SCIENCE COLLEGE, NAGPUR

Anant

Principal
PRINCIPAL

Dharampeth M. P. Deo Memorial
Science College, Nagpur-440033



DHARAMPETH M. P. DEO MEMORIAL SCIENCE COLLEGE,
North Ambazari Road, Near Ambazari Lake, Nagpur- 440033

DATA VALIDATION & VERIFICATION (DVV) final year (5thsem)

16)	Anjali K. Soni	7410564239	anjalisoni5748@gmail.com	Ani
17)	Nikita Bhagal			Nikita
18)	Jahnu Kader			Jahnu

Signature of
Ankita

Programme In-charge

Ms. Ankita Wankhede

COORDINATOR
INTERNAL QUALITY ASSURANCE CELL
DHARAMPETH, M. P. DEO MEMORIAL &
SCIENCE COLLEGE, NAGPUR

Principal
PRINCIPAL
Dharampeth M. P. Deo Memorial
Science College, Nagpur-440033



Dharampeth M. P. Deo Memorial Science College

HOME SCIENCE DEPARTMENT

*To,
Teaching and non Teaching staff*

It is our pleasure to invite all teaching &
non teaching staff to attend and enjoy food

**11:30 to 3
6 september 2022
NEAR CANTEEN**

**Your presence would add an
essence of sweetness**





DHARAMPETH M. P. DEO MEMORIAL SCIENCE COLLEGE, NAGPUR
INTERNAL QUALITY ASSURANCE CELL (IQAC)

Date: 12/09/2022

Name of Organizing Department or Committee: Home Science Department

Name of the activity: Group Discussion on applying Time Management in Handling day-to-day activities or transition (NEP Activity)

Suggested CRITERION point if any: Criteria II & V.

Date of Activity: 06/09/2022

Place of Activity: Classroom

Name of Guest Speaker/s or Judge/s or Chief Guest/s Resource Person if any:

Title of the Activity: Group Discussion on applying Time Management in Handling day-to-day activities or transition (NEP Activity)

Number of Participants: 08 students of Semester Ist participate in the activity.

Name of the Teacher In-charge / Convener: Ms. Ankita Wankhede

Names of other Committee Members / Staff: Mrs. Manju Deshpande

OUTCOME of the Activity with respect to mission vision of the institute and or academics:

1. Students learn Importance of time management and application of time management in their day to day activity.
2. Managing time effectively enables students to become more confident, organized, and learn more efficiently.
3. Proper time management help students be on track and cope with the stress of added responsibilities.

Activity with newspaper coverage if any: _____

Activity data save in PC of: Home Science Staff Room Desktop

Note: Kindly share geotag photographs separately along with report on iqacdsc2022@gmail.com



CO ORDINATOR
Internal Quality Assurance Cell
DHARAMPETH, M. P. DEO MEMORIAL &
SCIENCE COLLEGE, NAGPUR

Name & Signature of Teacher In-charge

Dr. Achillesh Peshwe
PRINCIPAL
Dharampeth M.P. Deo Memorial
Science College, Nagpur-440011



DHARAMPETH M. P. DEO MEMORIAL SCIENCE COLLEGE,
North Ambazari Road, Near Ambazari Lake, Nagpur-440033

DATA VALIDATION & VERIFICATION (DVV)

Name of the Programme :

Group Discussion on Time Management

Date of the Programme :

06/09/22

Name of Chief Guest if any :

Name of Guest Speaker if any :

Sr. No.	Name of the Participant	Mobile Number	E-mail Id	Signature
0.1	Shalu T. Pardhi	8829115380	shalupardhi@gmail.com	
2	Bhavana Guedasani	8888437305	bhavana.guedasani@gmail.com	
3.	Minal L. Patle	9158070732	patleminal83@gmail.com	
04	Aanchal D. Kokande	9309560449	achalkokande28@gmail.com	
5.	Aditi R. Vaidya	9075714591	aditivaidya619@gmail.com	
6.	SAKSHI R. CHAKUNDE	7843018801	sakshichakunde@gmail.com	
7.	Neha R. Vishwakarma	8983534173	nehavishwakarma81281@gmail.com	
8.	Ashwini N. Pandey	5308621072	ashwini.pandey.823@gmail.com	

Signature of

Programme In-charge

Ankita Wankhede

COORDINATOR

INTERNAL SAFETY ASSURANCE CELL
Dharampeth, M. P. Deo Memorial &
Science College, Nagpur

PRINCIPAL

Dharampeth, M. P. Deo Memorial
Science College, Nagpur-440033



DHARAMPETH M. P. DEO MEMORIAL SCIENCE COLLEGE, NAGPUR
INTERNAL QUALITY ASSURANCE CELL (IQAC)

Activity Report

Date: 29/09/2022

Name of Organizing Department or Committee: Computer Science

Name of the activity: Bridge Course

Suggested CRITERION point if any: V

Date of Activity: 07/09/2022 to 09/09/2022 (3 days)

Place of Activity: Room Number 05,10

Name of Guest Speaker/s or Judge/s or Chief Guest/s if any: NA

Title of the Activity: Bridge Course for Semester I Students

Number of Participants: More than 45

Name of the Teacher In-charge / Convener: Mrs. Ruma Kapre

Names of other Committee Members / Staff: NA

OUTCOME of the Activity with respect to mission vision of the institute and or academics:

Every year department takes Bridge Course for Semester I at entry level. This course covers basic knowledge of subject. Students learned all basic concepts and terminology used in the subject. Also through this course student learned what is programming, basic terminology which are required to write program and also the programming style. It bridges the gap of entry level students with the subjects.

Activity with newspaper coverage if any: NA

Activity data save in PC of: Mrs. Ruma Kapre

Mrs. Ruma Kapre

Name & Signature of Teacher In-charge

Prof. Pitambar Humane
IQAC Coordinator

CO ORDINATOR
INTERNAL QUALITY ASSURANCE CELL
DHARAMPETH M. P. DEO MEMORIAL &
SCIENCE COLLEGE, NAGPUR

Dr. Achillesh Peshwe
Principal

Principal
Dharampeth M.P. Deo Memorial
Science College, Nagpur.



Dharampeth M. P. Deo Memorial Science College, Nagpur
Department of Computer Science
Academic Session 2022-2023
Semester I
Bridge Course Syllabus

Sr. No	Contents	Classes Needed
1	What is Computer Functionality of Computer Block Diagram of Computer Advantages and Disadvantages of Computer	2
2	Key Software Types ↓ Assembler ↓ Compiler ↓ Interpreter ↓ Operating System ↓ User Application	
3	Components of Computer ↓ Input Unit ↓ Output Unit ↓ Memory Unit ↓ CPU	1
4	Introduction to Input and Output Devices	2
5	Memory Units ↓ Memory unit and description ↓ Cache Memory ↓ Primary Memory ↓ Secondary Memory ↓ Random Access Memory ↓ Read Only Memory	
6	Number System: - Introduction to ↓ Decimal Number System ↓ Binary Number System ↓ Octal Number System ↓ Hexa-Decimal Number System ↓ Conversion of Number System	2
7	Introduction to Programming ↓ Types of Programming Language ↓ Basic terminology in programming ↓ Hierarchy of computer language ↓ Characteristics of programming language ↓ How to write program	

Mrs. Ruma Kapre
Teacher In-Charge



DHARAMPETH M. P. DEO MEMORIAL SCIENCE COLLEGE,
North Ambazari Road, Near Ambazari Lake, Nagpur- 440033

DATA VALIDATION & VERIFICATION (DVV)

Name of the Programme : Bridge Course: Sem I: Day I [2 lectures]
Date of the Programme : 07/09/2022
Name of Chief Guest if any : _____
Name of Guest Speaker if any : _____

Sr. No.	Name of the Participant	Mobile Number	E-mail Id	Signature
1	Samiksha. A. Panchbudhe	9763075890	samikshapanchbudhe363@gmail.com	S.Panchbudhe
2	Prachi Pardhi	9263935912	prachipardhi282@gmail.com	P. la. Par
3	BADAL G. SOMKUWAR	7448247750	BADAL.SOMKUWAR1@gmail.com	Phd.
4	Amrta S. Karm	9028837552	karm17817@gmail.com	Amrta
5	Atul D. Thakre	9881956597	thakredavisigh@gmail.com	Atul Thakre
6	Gendhal B. Machade	9112142728	nikhilmachade@gmail.com	Gendhal Machade
7	LUCKY K. Navghare	9359626522	navgharelucky@gmail.com	Lucky
8	Vibhanshu K. Taine	9561232204	Vibhanshutaine7@gmail.com	Vibhanshu
9	Momay P. Patil	7350450579	momaypatil@gmail.com	Momay
10	Bevanli V. Gupta	7020069377	kg991537@gmail.com	B Gupta

Signature of:

Programme In-charge

IQAC Coordinator

CO ORDINATOR
INTERNAL QUALITY ASSURANCE CELL
DHARAMPETH, M. P. DEO MEMORIAL &
SCIENCE COLLEGE, NAGPUR

Principal

Principal
Dharampeth M.P. Deo Memorial
Science College, Nagpur.



DHARAMPETH M. P. DEO MEMORIAL SCIENCE COLLEGE,
North Ambazari Road, Near Ambazari Lake, Nagpur- 440033

DATA VALIDATION & VERIFICATION (DVV)

11	Jagmiti Fullkarwar	876794807	Jagmitifullkarwar@gmail.com	JIT
12	Janvi Kikrapale	7058235243	Janvi.kikrapale@gmail.com	Kikrapale
13	Divyani Zagade	9022866318	divyani@zagde@gmail.com	Louise
14	Janvi V. Khode	7385066634	Janvi.khode892@gmail.com	JKhode
15	Tsha Waghmare	8855919474	Tshauwaghmare9474@gmail.com	TW
16	Chetna Buike.	8010342968	Chetnabuikechetna@gmail.com	Chetna
17	Kashish Bisen	9887886117	kashishbisen05@gmail.com	KBisen
18	Bhagyashali D. Neware	7196434177	Sakshineware2017@gmail.com	B. Neware
19	Nisha B. Kasarkar	9890996645	nishakasarkar933@gmail.com	NKasarkar
20	Vaidhvi B. Gorgul	7507907278	gorgul.vaidhvi@gmail.com	Gorgul
21	Pranali R. Dehankar	8767581278	pranali@gmail.com	Pranali R.D
22	Sonia Niwal	7058425021	niwalsonia@gmail.com	SNiwal
23	Monali Shende	7796516257	shende.monali92@gmail.com	Monali
24	Sakshi Mishra	9529889315	Smishra39683@gmail.com	Smishra
25	Janvi Joge	7385060871	Janvijoge08ca@gmail.com	Janvi J
26	Janvi Lathey	8440510589	Janvilathey@gmail.com	Janvi

Signature of:

Programme In-charge

IQAC Coordinator

CO-ORDINATOR
INTERNAL QUALITY ASSURANCE CELL
DHARAMPETH, M. P. DEO MEMORIAL &
SCIENCE COLLEGE, NAGPUR

Principal

Dharampeth M. P. Deo Memorial
Science College, Nagpur.



DHARAMPETH M. P. DEO MEMORIAL SCIENCE COLLEGE,
North Ambazari Road, Near Ambazari Lake, Nagpur- 440033

DATA VALIDATION & VERIFICATION (DVV)

27	Rutika Yadav	84460859473	yadavrutika934@gmail.com	Rutika
28	Veena Borikar	9322016921	veenaborikar14@gmail.com	Veena
29	Varsha Turkar	9373650950	varshaturkar988@gmail.com	Varsha
30	Arju Rai	8149194497	arju08@gmail.com	Arju
31	Sandhya Sahu	9730806235	nehasahu15404@gmail.com	Sandhya
32	TANU . H. SINGH	8806955808	tanusingh63492@gmail.com	Tanu
33	Ishita Deshpande	9130091540	ishitaneshpande2004@gmail.com	Ishita
34	Simran Dhimale	7666330683	simrandhimale80@gmail.com	Dhimale
35	Mohit Khirdkar	9055328357	mohitkhirdkar@gmail.com	Mohitkar
36	Sandeep Kumar	8001144940	sandeepk27900@gmail.com	Sandeep
37	Aiket Bawankar	9767219301	AiketBawankar560@gmail.com	Bawankar
38	Vedant O. Umethkar	9049932753	Umethkarvedant@gmail.com	Umethkar
39	Priyanshu P. Singh	9523710380	Priyanshusinghji@gmail.com	P Singh
40	Tushar R. Achare	9075995617	achartushar15@gmail.com	Tushar
41	Uday C. Baghel	8459543609	bagheluday@gmail.com	Uday
42	Tejas Dongre	9322578918	Tejasdongre9874k@gmail.com	Tejas

Signature of:

Programme In-charge

IQAC Coordinator
CO ORDINATOR
INTERNAL QUALITY ASSURANCE CELL
DHARAMPETH, M. P. DEO MEMORIAL &
SCIENCE COLLEGE, NAGPUR

Principal
Principal

Dharampeth M.P. Deo Memorial
Science College, Nagpur.



DHARAMPETH M. P. DEO MEMORIAL SCIENCE COLLEGE,
North Ambazari Road, Near Ambazari Lake, Nagpur- 440033

DATA VALIDATION & VERIFICATION (DVV)

43	Abhishek R. Singh	8208948107	abhi082005@gmail.com Singh
44	Deepak Kumar	7061735473	Sharma deepak K 2005@gmail.com Deepak
45	Ritik H. Hiranwar	7498066424	Ritik.Hiranwar57@gmail.com Hiranwar
46	Pratik D. Chalakh	9021690532	pratikchalakh007@gmail.com Chalakh
47	Pratik H. Hiranwar	8329788243	Pratik.Hiranwar163@gmail.com Pratik
48	Rahul S. Pandey	8767788403	sp935652@gmail.com Pandey
49	Khushi Pali	8767607224	klikhushi1@gmail.com Khushi
50	Aayushi V. Singh	7498985604	aayushisingh6591@gmail.com Singh
51	Khushbu Pali	8459565214	paliKhushbu59@gmail.com Pali
52	Divyani Zade	7972403069	divyanizade2005@gmail.com Zade
53	Aditi Jogi	9579962108	aditi.jogi2002@gmail.com Aditi
54	Pradnya Tipude	8010362232	pradnyatipude9145@gmail.com Tipude
55	Utkasha Ingale	7499159178	utkasha.ingale9@gmail.com Ingale

Signature of:

Programme In-charge

IOAC Coordinator
CO ORDINATOR
INTERNAL QUALITY ASSURANCE CELL
DHARAMPETH, M. P. DEO MEMORIAL &
SCIENCE COLLEGE, NAGPUR

Principal
Principal
Dharampeth M.P. Deo Memorial
Science College, Nagpur.



DHARAMPETH M. P. DEO MEMORIAL SCIENCE COLLEGE,
North Ambazari Road, Near Ambazari Lake, Nagpur- 440033

DATA VALIDATION & VERIFICATION (DVV)

Name of the Programme : Bridge course : Sem. I : Day 2 [2 lectures]
Date of the Programme : 8/09/2022
Name of Chief Guest if any : _____
Name of Guest Speaker if any : _____

Sr. No.	Name of the Participant	Mobile Number	E-mail Id	Signature
1)	Janhvi A. Kisanpuro	7052235243	janhvikisanpuro@gmail.com	Jisanpuro
2)	Branali V. Gupta	7020069377	xy991537@gmail.com	Gupta
3)	Jagriti Fulkawar	8767911809	Jagritifulkawar@gmail.com	Jagriti
4)	Divyani Zagade	9022866318	divyanizagade@gmail.com	Zagade
5)	Samiksha A. Panchbudhe	9763075890	samikshapanibudhe@gmail.com	S. Panchbudhe
6)	Janvi V. Khode	7385066634	JanviKhode12@gmail.com	Khode
7)	Pooja S. Konkale	7385554139	poojakonkale28@gmail.com	Pooja S. Konkale
8)	Aditi S. Jogi	9579962108	aditi.jogi2002@gmail.com	Aditi
9)	Sonia S. Niwal	7058425021	niwal/sonia70@gmail.com	Niwal
10)	Pradnya B. Tirpude	5010362232	pradnyatirpude9145@gmail.com	Tirpude

Signature of:

Programme In-charge

IQAC Coordinator

INTERNAL QUALITY ASSURANCE CELL
DHARAMPETH, M. P. DEO MEMORIAL &
SCIENCE COLLEGE, NAGPUR

Principal
Principal

Dharampeth M.P. Deo Memorial
Science College, Nagpur.



DHARAMPETH M. P. DEO MEMORIAL SCIENCE COLLEGE,
North Ambazari Road, Near Ambazari Lake, Nagpur- 440033

DATA VALIDATION & VERIFICATION (DVV)

11	Preetiksha Y. Basave	9579936918	preetikshabasave49@gmail.com - Preetikshabasave
12	Tanuja G. Yelwe	9529447565	tanujayelwe728@gmail.com - J.G. Yelwe
13	BADAL G. SOMKUWAR	7448247750	badalsomkuwar1@gmail.com - Badal
14	Tejas Dongre	9322578918	Tejadongre9874@gmail.com - Tejas
15	Smriti Mishra	9158788969	Smriti89683@gmail.com - Smriti
16	Janhvi Joge	7249790035	JanhviJoge08@gmail.com - Janhvi
17	Pranali Dehankar	8767581278	Pehna@gmail.com - Pranali RID
18	Aayushi V. Singh	7498985604	Singhpreeti74696@gmail.com - Singh
19	Vidhvee B. Gogal	7507907278	gogalvidhvee@gmail.com - Gogal
20	Nisha S. Kosarkar	9890996645	nishakosarkar333@gmail.com - Nisha
21	Vedant O. Urathre	9049932753	urathrevedant@gmail.com - Urathre
22	Tushal R. Achare	9075995617	acharetushal5@gmail.com - Achare
23	Amrta S. Karm	9028837552	karm7817@gmail.com - Amrta
24	Deepak Kawartha	7061735973	Sharma deepak KK @ - Deepak
25	Mohit Manoti Khindekar	9055328357	mohitkhindekar@gmail.com - Mohit

Signature of:

Programme In-charge

CO-ORDINATOR

INTERNAL QUALITY ASSURANCE CELL
DHARAMPETH, M. P. DEO MEMORIAL &
SCIENCE COLLEGE, NAGPUR

Principal
Principal

Dharampeth M.P. Deo Memorial
Science College, Nagpur.



DHARAMPETH M. P. DEO MEMORIAL SCIENCE COLLEGE,
North Ambazari Road, Near Ambazari Lake, Nagpur- 440033

DATA VALIDATION & VERIFICATION (DVV)

26	Ved.S.Choudhary	7498572766	vedchoudhary.cs.749@gmail.com	Ved.
27	Bhagyashali D. Newase	7796434177	sakshinewase2017@gmail.com	B.D. Newase
28	Simran Bhimale	9284588851	mishralaxmi210@gmail.com	@bhimale
29	Arju Rai	8149194497	rarju08@gmail.com	Arju
30	Rutika Yadav	8446085949	yadavarutika439@gmail.com	Rutika
31	Varsha Turkar	9373650950	varshaturkar488@gmail.com	Varsha
32	Tanu. A. Singh	8806355808	tanusingh63492@gmail.com	Tanu
33	Veena W. Borikar	9322016921	veenaborikar14@gmail.com	Veena
34	Ishita Deshpande	9132091540	ishitandeshpande21004@gmail.com	Ishita

Signature of:

Programme In-charge



CO ORDINATOR
INTERNAL QUALITY ASSURANCE CELL
DHARAMPETH, M. P. DEO MEMORIAL &
SCIENCE COLLEGE, NAGPUR

Principal
Principal

Dharampeth M.P. Deo Memorial
Science College, Nagpur.



DHARAMPETH M. P. DEO MEMORIAL SCIENCE COLLEGE,
North Ambazari Road, Near Ambazari Lake, Nagpur- 440033

DATA VALIDATION & VERIFICATION (DVV)

Name of the Programme : Bridge Course : sem I. : Day 3 [2 lectures]
Date of the Programme : 09/09/2022
Name of Chief Guest if any : _____
Name of Guest Speaker if any : _____

Sr. No.	Name of the Participant	Mobile Number	E-mail Id	Signature
1]	Beerali V. Gupta	70200 69377	xy991537@gmail.com	<u>Gupta</u>
2]	Janki A. Kisanpuro	7058235243	janvikisanpuro@gmail.com	<u>Kisanpuro</u>
3]	Divyani V. Zagade	9022 866 318	divyanizagade@gmail.com	<u>Zagade</u>
4]	Pradnya B. Tirpude	8010362232	pradnyetirpude@91et@gmail.com	<u>Tirpude</u>
5]	Kashish K. Bisen	7887886114	Kashishbisen05@gmail.com	<u>K. Bisen</u>
6]	Khushi R. Tali	8767607224	Pallikhushi4@gmail.com	<u>Khushi</u>
7]	Jagruti Fulkar	8767 911807	JagrutiFulkar@gmail.com	<u>Jagruti</u>
8]	Muskan C. Vaidya	9309773287	muskanvaidya9@gmail.com	<u>M. Vaidya</u>
9]	Pratiksha G. Bawle	9579936218	Pratikshabawle49@gmail.com	<u>Pratikshabawle</u>
10]	Tanuja G. Yeluse	9529267565	tanujayeluse428@gmail.com	<u>T. G. Yeluse</u>

Signature of:

[Signature]
Programme In-charge

[Signature]
IQAC Coordinator
CO ORDINATOR
INTERNAL QUALITY ASSURANCE CELL
DHARAMPETH, M. P. DEO MEMORIAL &
SCIENCE COLLEGE, NAGPUR

[Signature]
Principal
Principal
Dharampeth M.P. Deo Memorial
Science College, Nagpur.



DHARAMPETH M. P. DEO MEMORIAL SCIENCE COLLEGE,
North Ambazari Road, Near Ambazari Lake, Nagpur- 440033

DATA VALIDATION & VERIFICATION (DVV)

11]	Kalyani Pravin fardade	8626038611	Kalyanifardade@gmail.com	Kfardade
12]	Sonu Sanjay Niwal	7058425021	niwalsonu70@gmail.com	glniwal
13]	Vidya Eknath Lohi	7020963219	Vidyalohi8@gmail.com	Lohi
14]	deveshvi Prasad kulkarni	9308890446	Deveshvikulkarni@gmail.com	Dpkulkarni
15]	Monali Narendraj Shende	7796516257	shendemonali92@gmail.com	Mshende
16]	Vibhanshu Krushna Tane	9561232204	Vibhanshutane7@gmail.com	Vibhanshu
17]	Lucky Kankraj Navghare	9359626522	navgharelucky@gmail.com	Lucky
18]	Priyanshu Pradeep Singh	9527710380	Priyanshusinghji0012@gmail.com	P Singh
19]	Manu P Pal	7350450579	manupal735045@gmail.com	Manu
20]	Gendal Bhojraj Maclade	9112142728	gndalmaclade@gmail.com	Gendal
21]	Vedant Anant Umsetkar	9049932753	umsetkarvedant@gmail.com	Vedant
22]	Amran Sujit Kavan	9028837552	kavan7817@gmail.com	Amran
23]	Tejas Dongre	9322578918	Tejasdongre453@gmail.com	Tejas
24]	Deepak Kulkarni	7061735473	deepakkk2005@gmail.com	Deepak
25]	Sandeep Kulkarni	8001144940	Sand@epk27900@gmail.com	Sandeep

Signature of:

Programme In-charge

COORDINATOR
INTERNAL QUALITY ASSURANCE CELL
DHARAMPETH, M. P. DEO MEMORIAL &
SCIENCE COLLEGE, NAGPUR

Principal

Dharampeth M.P. Deo Memorial
Science College, Nagpur.



DHARAMPETH M. P. DEO MEMORIAL SCIENCE COLLEGE,
North Ambazari Road, Near Ambazari Lake, Nagpur- 440033

DATA VALIDATION & VERIFICATION (DVV)

26.	Ved. S. Choudhary	7498572766	vedchoudhary.cs.7u@gmail.com	<u>Pod</u>
27.	BADAL G. SOMKUWAR	7448247750	badalsomkuwar1@gmail.com	<u>Badal</u>
28.	Ishita N. Deshpande	9130091540	ishitandeshpande21004@gmail.com	<u>Ishita</u>
29.	Vansha L. Turkar	9373650950	vanshaturkar488@gmail.com	<u>Vansha</u>
30.	Veena U. Berikar	9322016921	veenaberikar14@gmail.com	<u>Veena</u>
31.	Aayushi V. Singh	7498985604	singhpaiti74096@gmail.com	<u>Singh</u>
32.	Shushbu Pali	8459565214	paliShushbu59@gmail.com	<u>Shushbu</u>
33.	Samiksha A. Panchbudhe	9763075890	samikshapanchbudhe@gmail.com	<u>S. Panchbudhe</u>
34.	Tanvi V. Khode	7385066634	Tanvikhode@gmail.com	<u>Tanvi</u>
35.	Mudit M Khirdkar	8055328357	mditkhirdkar@gmail.com	<u>Mudit</u>
36.	Tanvi M Jage	7249790035	TanviJage08@gmail.com	<u>Tanvi</u>
37.	Tanvi H. Laibey	8440510539	Thomilaibey@gmail.com	<u>Tanvi</u>
38.	Sakshi A. Mishra	9158788969	Smishra39683@gmail.com	<u>Smishra</u>
39.	TANU .AJAY .SINGH	8806855808	tanusingh63499@gmail.com	<u>Tanu</u>
40.	Bhagyashali D. Neware	7196434177	sakshineware2017@gmail.com	<u>B.D. Neware</u>

Signature of:

Programme In-charge

COORDINATOR
INTERNAL QUALITY ASSURANCE CELL
DHARAMPETH, M. P. DEO MEMORIAL &
SCIENCE COLLEGE, NAGPUR

Principal
Principal
Dharampeth M.P. Deo Memorial
Science College, Nagpur.



DHARAMPETH M. P. DEO MEMORIAL SCIENCE COLLEGE,
North Ambazari Road, Near Ambazari Lake, Nagpur- 440033

DATA VALIDATION & VERIFICATION (DVV)

41.	Isha T. Waghmare	9855919474	ishawaghmare9474@gmail.com	Isha
42.	chetna S. Buiwile.	8010342968	buiwilechetna@gmail.com	chetna
43.	Nisha S. Karankar	9890996645	nishakarankar@gmail.com	Nishankar
44.	Bramali R. Dehankar	8767581278	adehna@gmail.com	Bramali R ID
45.	Vaidhavi B. Gangal	7507901278	gangalvaidhavi@gmail.com	Vaidhavi

Signature of:

Program In-charge

COORDINATOR
INTERNAL QUALITY ASSURANCE CELL
DHARAMPETH, M. P. DEO MEMORIAL &
SCIENCE COLLEGE, NAGPUR

Principal
Principal
Dharampeth M.P. Deo Memorial
Science College, Nagpur.

NOTICE

All the students are hereby informed that a program for the of Microbiology Association ""Microbliss"" will be organized by the Microbiology Department.

The cooperation of all the students will be solicited. To conduct this program everybody from Sem 1, 3, 5 has to pay 50 rupees compulsorly on or before 25th of August. The mode of payment will be online. Various activities throughout the year will be conducted under this Association and compulsorly participation for all is necessary.

Online payment should be done on (TREASURE) Ishika Thakre's Number : 8010907069

and also send screenshot of the payment for the proof.

V. R. Kathoke
Dr. V. R. Kathoke
Head Department of Microbiology

Dr. V. R. Kathoke
Head
Department of Microbiology
D. Y. Patil College of Arts, Science & Commerce
Warananagar, Mumbai

REPORT

INSTALLATION MICROBIOLOGY ASSOCIATION * MICROBLISS *

Microbiologist Association of student's "Microbliss" 2022 inaugurated in Dept. of Microbiology, Dharampeth M.P. Deo memorial science college, Nagpur on 8th September 2022. The program was inaugurated at the hands of guest of honour, Principal Dr. Akhilesh Peshwe, Dr. S.D. Patankar, National Convener, Microbiologist Society of India was present as the chief guest. Dr. Vidya Kathoke, HOD, Dept. of Microbiology gave introductory remarks and declared body members of Students unit "Microbliss". Dr. Akhilesh Peshwe motivated the students to participate in undergraduate research. On this occasion Dr. S.D. Patankar delivered his guest lecture on "career opportunities in life sciences", which helped students to enlighten their career path. Dr. Pitamber Humane, IQAC, coordinator of college and teaching staff Dr. Vaishali Pimple, Dr. Pratiksha Pohekar, Miss. Diksha Zade and students were present on this occasion.

THE LIST OF WORKING BODY MEMBERS OF THE MICROBLISS ASSOCIATION-

- 1) President - Shreyansh Naikwar
- 2) Vice president - Anjali Pali
- 3) Secretary - Shruti Pawar
- 4) Treasures- Ishika Thakre
- 5) Convener- Nandini Hadge
- 6) Co-ordinator- Anushri Wele
- 7) Facilitator- Laxmi Gorle, Bhargavi Sambhare, Madhura Bhondwe, Rinam Wankhade, Sooraj yadav, Sanket Lode....
- 8) Volunteers-

DVV- *enclosed*

facebook

Dharampeth M. P. Deo Memorial Science College, Nagpur is on Facebook. To connect with Dharampeth M. P. Deo Memorial Science College, Nagpur, log in to Facebook.

Login

or

Join



Dharampeth M. P. Deo Memorial Science College, Nagpur

10 September at 08:50 · 🌐

Microbiologist Association of student's "Microbliss 2022" inaugurated by Department of Microbiology, Dharampeth M. P. Deo Memorial Science College, Nagpur on 8th September 2022.

The program was inaugurated at the hands of Guest of Honour, Principal, Dr. Akhilesh Peshwe, Chief Guest Dr. S. D. Patankar, National Convener, Microbiologist Society of India.

Dr. Vidya Kathoke, HOD, Department of Microbiology gave Introductory Remarks and declared body members of Students unit "Microbliss".

Dr. Akhilesh Peshwe motivated the students to participate in undergraduate research.

On this occasion Dr. S. D. Patankar delivered his guest lecture on "career opportunities in life sciences", Prof. Pitamber Humane, IQAC Coordinator and Teaching Staff of Department Dr. Vaishali Pimple, Dr. Pratiksha Pohekar, Miss. Diksha Zade and students were present for the Inauguration.



🔗 Share



Dharampeth M.P Deo Memorial Science College
Ambazari, Nagpur.

Date
08/09/2022

DEPARTMENT OF MICROBIOLOGY

On behalf of Dharampeth M. P. Deo Memorial Science College and Department of Microbiology it gives me immense pleasure and gratitude to extend my thanks towards Dr. S. D. Patankar, National Co-Ordinator, Microbiologists Society of India, who was present as a Chief Guest on the occasion of Inauguration of Microbiology Society Students Unit named "MICROBLISS" and guided our students by giving guest lecture on the topic-"Career Opportunities in Microbiology and Biotechnology"

Thanks Once again sir for gracing our event.

V. R. Kathoke

Dr. V. R. Kathoke

Dr. V. R. Kathoke

Head

Deptt. of Microbiology
Dharampeth MP Deo Memorial
Science College, Nagpur



DHARAMPETH M. P. DEO MEMORIAL SCIENCE COLLEGE,
North Ambazari Road, Near Ambazari Lake, Nagpur- 440033

DATA VAUDATION & VERIFICATION (DVV)

Name of the Programme

MICROBLISS BODY MEMBERS

Date of the Programme

8th September 2022

Name of Chief Guest if any

Guest of Honour Akhilesh Peshwe

Name of Guest Speaker if any

Dr. Sanjeev Patankar

Sr. No.	Name of the Participant	Mobile Number	E-mail Id	Signature
1	Shreyansh S. Naikwar (President)	7447344183	shreyanshnaikwar7@gmail.	
2	Anushi S. Wele [Coordinator]	8530778433	anushiweles00@gmail.com	
3	Anjali R. Pali [Vice President]	7498102109	palianjali446@gmail.com	
4	Laxmi Gaule [Facilitator]	7758058514	laxmigaule@gmail.com	
5	Ishika S. Thakre [Treasurer]	801907069	ishi.thakre@gmail.com	

Signature of

Propositive incharge

IQAC Coordinator

Principal
Dharampeth M. P. Deo Memorial
Science College, Nagpur



DHARAMPETH M. P. DEO MEMORIAL SCIENCE COLLEGE,
North Ambazari Road, Near Ambazari Lake, Nagpur- 440033

DATA VALIDATION & VERIFICATION (DVV)

6	Gargi Hadge	7972076671	gargihadge@gmail.com	Hadge -
7	Vaishnavi Gadge	9022976449	gadyvaishnavi00@gmail.com	Gadge
8	Nandini Hadge (convenor)	9370301679	nandinihadge17@gmail.com	Hadge
	Kamini Pawar	7758055514	kamini.pawar@gmail.com	Pawar
9	Shruti M. Pawar (Secretary)	9527985707	Shruti.pawar0001@gmail.com	Pawar
	Ayushi D. Shukla	9373668043	ayushishukla2502002@gmail.com	Shukla
10	Pranali Y. Chavhare (Volunteer)	9699654562	pranalichavharecs@gmail.com	Chavhare
11	Pratiksha M. Meshram (Volunteer)	8459070338	meshrampratiksha14@gmail.com	Meshram

Signature of

Pratiksha
Programme in-charge

IQAC Coordinator

Principal

Dharampeth M. P. Deo Memorial
Science College Nagpur

Principal



DHARAMPETH M. P. DEO MEMORIAL SCIENCE COLLEGE,
North Ambazari Road, Near Ambazari Lake, Nagpur- 440033

DATA VALIDATION & VERIFICATION (DVV)

5th sem (Third year)

Total No of students 46

Name of the Programme : Microbiology student Association
 Date of the Programme : 08/09/2022
 Name of Chief Guest if any : Guest of Honour - Dr Akhilesh Peshwe
 Name of Guest Speaker if any : Dr Sanjeev Patankar, National Convener, Microbiology Society of India

Sr. No.	Name of the Participant	Mobile Number	E-mail Id	Signature
1	Madhura Umesh Bhondure	8767484914	madhurabhondure@gmail	
2	Ayushi Shukla	9373668043	ayushishukla28112002@gmail	
3	Shuman Ashutosh Singh	7249465307	missymansingh9@gmail	
4	Samiksha R. Chaudhary	7517090406	Chaudharysamiksha26@gmail.com	
5	Samiksha N. Kundekar	9145253758	samikshakundekar@gmail.com	
6	Sayli S. Lokhande	9356413804	SayaliLokhande2310@gmail.com	
7	Balraj M. Wadga	9420396682	Balrajwadga2002@gmail	
8	Rupesh W. Wadde	8329676611	Rupeshwadde7300@gmail	
9	Vivek R. Waghmare	8956482591	vivekkrishnawaghmare@gmail	
10	Bhumika D. chedde	8880391103	bhumikachedde@gmail.com	

Signature of:

Programme In-charge

IQAC Coordinator

Principal
Dharampeth Principal Deo Memorial
Science College Nagpur



DHARAMPETH M. P. DEO MEMORIAL SCIENCE COLLEGE,
North Ambazari Road, Near Ambazari Lake, Nagpur- 440033

DATA VALIDATION & VERIFICATION (DVV)

11.	Sanskarti S. Panchbhare	7447613185	sanskarti.panchbhare459@gmail.com	<i>Sanskarti</i>
12.	Shiwani S.R. Dwivedi	8855900546	ShiwaniDwivedi14@gmail.com	<i>Shiwani</i>
13.	Amushi S. Wale	8530778433	amushiwale2001@gmail.com	<i>Amushi</i>
14.	Bhargavi A. Sambare	7709403806	bhargavisambare05@gmail.com	<i>Bhargavi</i>
15.	Nandini S. Hodge	9370301679	nandinihodge17@gmail.com	<i>Nandini</i>
16.	Jaxmi M. Gorle	775805814	jaxmigorle@gmail.com	<i>Jaxmi</i>
17.	Shruti M. Pawar	9527988707	ShrutiPawar0707@gmail.com	<i>Shruti</i>
18.	Rinam C Wankhede	8010966529	wankhederinam07@gmail.com	<i>Rinam</i>
19.	Suraj S. Yadav	8767435168	Surajshyamjadar82@gmail.com	<i>Suraj</i>
20.	Sanket K. Lode	7972085380	Sanketlode123@gmail.com	<i>Sanket</i>
21.	Aishwarya A. Joshi	7498328662	aishwaryajoshi2003@gmail.com	<i>Aishwarya</i>
22.	Neha J. Chandratre	9156873792	nehachandratre31@gmail.com	<i>Neha</i>
23.	Ishika S. Thakre	8010907069	ishikaThakre@gmail.com	<i>Ishika</i>
24.	Angali R. Pali	9021645689	Angali.pali@gmail.com	<i>Angali</i>

Signature of:

Prabhakar
Programme In-charge

IQAC Coordinator

Principal
Dharampeth M. P. Deo Memorial
Science College Nagpur



DHARAMPETH M. P. DEO MEMORIAL SCIENCE COLLEGE,
North Ambazari Road, Near Ambazari Lake, Nagpur- 440033

DATA VALIDATION & VERIFICATION (DVV)

Sem - I (First year)

Name of the Programme

: MICROBIOLOGY STUDENTS ASSOCIATION (MICROBLESS)

Date of the Programme

: 08/09/2022

Name of Chief Guest if any

: Dr Akhilesh Peshwe

Name of Guest Speaker if any

: Dr Sanjeev Patankar, National Convener, Microbiology Society of India

Sr. No.	Name of the Participant	Mobile Number	E-mail Id	Signature
1	Ashwini Mangesh Narote	8275566422	ashwininrote123@gmail.com	Ashwini..
2	Umang - G. Wanthi	9322428500	umangwanthi@gmail.com	Umang
3	Ritika R. Sandhya	9175581655	ritikasandhya@gmail.com	Ritika
4	Sonali G. Chaudhari	8856055003	sonalichaudhari17@gmail.com	Sonali
5	Muskan V. Kulkarni	9156889239	muskanmkulkarni34@gmail.com	Muskan
6	Komalika S. Chaudhari	9322033866	Komalikachaudhari073@gmail.com	KChaudhari
7	Neha L. Wanjari	9373832266	nehawanjari333@gmail.com	NWanjari
8	Priya R. Dubey	8669465362	dubey.priyashriya@gmail.com	PriyaDubey
9	Yogita R. Derge	7058437240	yogitaderge@gmail.com	YDerge
10	Gunjan R. Bhojrao	8668335876	gunjanbhojrao34@gmail.com	Gunjan

Signature of:

Programme In-charge

IQAC Coordinator

Principal
Dharampeth M. P. Deo Memorial
Science College, Nagpur



DHARAMPETH M. P. DEO MEMORIAL SCIENCE COLLEGE,
North Ambazari Road, Near Ambazari Lake, Nagpur- 440033

DATA VALIDATION & VERIFICATION (DVV)

11) Dhanashri Neware	9358909913	dhanashrineware186@gmail.com	Spice
12) Pranali Chavhare	9699654562	pranali.chavhare.99@gmail.com	Pharlat
13) Meenal Chalkare	9529014804	meenali.chalkare@gmail.com	Chalkare
14) Siddhi Tiwari	8087143696	siddhitiwari0321@gmail.com	Siddhi
15) Pratisha Meshram	8459070338	meshrampratisha.H@gmail.com	Pratisha
16) Sharvani Umare	9284269536	sharvani.umare.912@gmail.com	Umare
17) Khushi Rewade	9588445994	khushirewade@gmail.com	Rewade
18) Aakansha Maizal	8010923662	aakanyogi - @ gmail com	Ayaz

Signature of:

Pranali Chavhare
Programme In-charge

IQAC Coordinator

Principal
Dharampeth M. P. Deo Memorial
Science College, Nagpur

Principal



DHARAMPETH M. P. DEO MEMORIAL SCIENCE COLLEGE, NAGPUR
INTERNAL QUALITY ASSURANCE CELL (IQAC)

Activity Report

Date: 29/09/2022

Name of Organizing Department or Committee: IQAC Initiative

Name of the activity: Orientation Program

Suggested CRITERION point if any: VI

Date of Activity: 08/09/2022

Place of Activity: Late Vinaykarao Phatak Hall

Name of Guest Speaker/s or Judge/s or Chief Guest/s if any: Dr. Akhilesh Peshwe, Principal

Title of the Activity: Orientation Program for Certificate Courses at V R Jamdar Siemens Centre of Excellence, VNIT, Nagpur

Number of Participants: 76

Name of the Teacher In-charge / Convener: Mrs. Ruma Kapre

Names of other Committee Members / Staff: NA

OUTCOME of the Activity with respect to mission vision of the institute and or academics:

In the Academic Session B.Sc. Final Year students of Mathematics Group got registered for the Certificate Courses at V R Jamdar Siemens Centre of Excellence, VNIT, Nagpur. In connection to this, Honourable Principal Sir interacted with the students to give complete information about the certificate courses. He gave them all information about the aims and objectives, outcome and importance of courses. He stated the courses were specially designed for B.Sc. Program by academic experts from VNIT which will cater to their cognitive capabilities He motivated all the student and emphasizes that college has taken this initiative to enhance their employability skills in attaining future job prospectus. He appealed students to give their best to complete the course.

Activity with newspaper coverage if any: NA

Activity data save in PC of: Mrs. Ruma Kapre



Prof. Pitambar Humane
IQAC Coordinator

CO ORDINATOR

INTERNAL QUALITY ASSURANCE CELL
DHARAMPETH M. P. DEO MEMORIAL &
SCIENCE COLLEGE, NAGPUR

Mrs. Ruma Kapre

Name & Signature of Teacher In-charge

Dr. Akhilesh Peshwe
Principal

Dharampeth M.P. Deo Memorial
Science College, Nagpur



DHARAMPETH M. P. DEO MEMORIAL SCIENCE COLLEGE,
North Ambazari Road, Near Ambazari Lake, Nagpur- 440033

DATA VALIDATION & VERIFICATION (DVV)

Name of the Programme : Orientation Program for Certificate Courses at V.R. Jandkar
Date of the Programme : 08/09/2022 Siemens Centre of Excellence,
Name of Chief Guest if any : Dr. Akhilesh Peshwe, Principal DMPDMSC, VNIT, Nagpur.
Name of Guest Speaker if any : _____

Sr. No.	Name of the Participant	Mobile Number	E-mail Id	Signature
1	Pranay S. Mahajan	7385551492	Pranaymahajan@gmail.com	Pranay
2	Pratham-m-sanan	9011144790	sanap.pratham434@gmail.com	Pratham
3	Rajat L. Rohad.	9175635273	RajatRohad412@gmail.com	Rajat
4	Mukund S. Hood.	9604785822	mukundhood2003@gmail.com	M Hood
5	Nikhil K. Jankar	8530960404	NikhilJankar@gmail.com	Nikhil
6	Mahesh. P. Maske	9021951173	maheshmaske48@gmail.com	M Maske
7	Bhaves R. Maske	7989951631	bhavesmaske2002@gmail.com	B Maske
8	Shivam S. Malwade	9607873702	Shivammalwade1991@gmail.com	Shivam
9	Chetan Kamthe	9637271601	Kamthechetan6@gmail.com	Chetan
10	Anshuman Sharma	9370892462	anshumansharma8314@gmail.com	Anshuman

Signature of:

Programme In-charge

Mrs. Ruma Kapre

IQAC Coordinator
CO ORDINATOR

INTERNAL QUALITY ASSURANCE CELL
DHARAMPETH, M. P. DEO MEMORIAL &
SCIENCE COLLEGE, NAGPUR

Principal

Dharampeth M. P. Deo Memorial
Science College, Nagpur.



DHARAMPETH M. P. DEO MEMORIAL SCIENCE COLLEGE,
North Ambazari Road, Near Ambazari Lake, Nagpur- 440033

DATA VALIDATION & VERIFICATION (DVV)

11.	Priyanshu B. Singh	7775800561	singhpriyanshu0786@gmail.com	
12.	Akash A. Sikdar	9175422051	sikdarakash15@gmail.com	
13.	Vishal Ku. Singh	9610187223	singhvishal9602@gmail.com	
14.	Adesh K. Hatwar	7517431162	adeshhatwar2002@gmail.com	
15.	Prathmesh Badhye	9765262138	Prathmeshbadhye@gmail.com	
16.	Aarti B. Singh	7709208740	Aartibsingh222@gmail.com	
17.	Riddhi A. Rajkarne	9668974021	RiddhiRajkarne9@gmail.com	
18.	Aditi K. Dhoble	8847709511	aditidhoble4@gmail.com	
19.	Aachal S. Wagh	9579643389	aachalwagh2005@gmail.com	
20.	Nikita D. Shebe	9021019101	nikita.shebe2019@gmail.com	
21.	Tanushree R. Dafe	9766927406	tanushreedafe22@gmail.com	
22.	Pranjal Sawudkar	7385458510	pranjal_sawu1234@gmail.com	
23.	Ruchita Bhojari	9527832686	ruchitabhoyar107@gmail.com	
24.	Mukesh Oraon	8379049368	Oraonm64@gmail.com	
25.	Khushi Dave	9890009937	Kd858747@gmail.com	

Signature of:

Programme In-charge

CO ORDINATOR
INTERNATIONAL COORDINATOR
CHARAMPETH, M. P. DEO MEMORIAL &
SCIENCE COLLEGE, NAGPUR

Principal
Dharampeth M.P. Deo Memorial
Science College, Nagpur.



DHARAMPETH M. P. DEO MEMORIAL SCIENCE COLLEGE,
North Ambazari Road, Near Ambazari Lake, Nagpur- 440033

DATA VALIDATION & VERIFICATION (DVV)

26	Diya Patil	7757052463	diyapatil557@gmail.com	<u>Patil</u>
27	Sahil Jivode	9373414643	sahiljivode73@gmail.com	<u>Jivode</u>
28	Prachi Varabhe	9325336932	PrachiVarabhe@gmail.com	<u>Varabhe</u>
29	Tanu Mohule	7057844382	tanumohule45@gmail.com	<u>Mohule</u>
30	Komal Kumbhare	7620314869	kumbharekomal94@gmail.com	<u>Komal</u>
31	Neha Bunkar	8055477553	neha2002bunkar@gmail.com	<u>Bunkar</u>
32	Bhatham. P. Gupta	8762775149	Bhathamgupta1476@gmail.com	<u>Bhatham</u>
33	Dolly Gabbhane	9284269236	dollygabbhane7@gmail.com	<u>Gabbhane</u>
34	Khushi Gupta	9022997235	kg098920@gmail.com	<u>Gupta</u>
35	Samiksha Khosare	9604473539	rekhaKhosare@gmail.com	<u>Khosare</u>
36	Rani Kokate	7498945148	Ranikokate109@gmail.com	<u>Kokate</u>
37	Sanchit Joshi	8975706788	Sanchit.joshi02@gmail.com	<u>Joshi</u>
38	Abhishek A. Falke	7823835535	abhishekfalke888@gmail.com	<u>Falke</u>
39	Akash Das	7972942799	akashdab@hotmail.com	<u>Das</u>
40	Abdul Raaf Aman	7666238578	raafaman2571@gmail.com	<u>Abdul</u>

Signature of:

Pune
Programme In-charge

Amr.

CO-ORDINATOR
INTERNAL QUALITY ASSURANCE CELL
DHARAMPETH, M. P. DEO MEMORIAL &
SCIENCE COLLEGE, NAGPUR

Kumar
Principal

Dharampeth M.P. Deo Memorial
Science College, Nagpur.



DHARAMPETH M. P. DEO MEMORIAL SCIENCE COLLEGE,
North Ambazari Road, Near Ambazari Lake, Nagpur- 440033

DATA VALIDATION & VERIFICATION (DVV)

41	Kw. Sujata. Phansraj. Sawant	9021155140	sujatasawant@gmail.com	Sujata
42	Damini Mahadeo Bandburke	8275105785	bandburkedamini@gmail.com	D. Bandburke
43	Supriya Patle	7757871925	Patle.supriya021@gmail.com	Patle
44	Seema Madan Lakadg	7058728070	seemalakda073@gmail.com	Seemalakda
45	Pratiksha Shivdas Chaudhari	7507317699	chaudharyPratiksha00@gmail.com	Pratiksha
46	Soni Arun Rai	8855989508	soniArunrai17@gmail.com	Soni
47	Chaitali Burebade	9359540994	Uaitali2006@gmail.com	Chaitali
48	Akanksha R. Veluze	8767935524	akankshaVeluze@gmail.com	Akanksha
49	Priyanka Jha	9665852975	priyankaj697@gmail.com	Priyanka
50	Priyanshi Singh	7219259020	priyanshisingh1040@gmail.com	Priyanshi
51	Anushka Das	7058933157	ad04092001@gmail.com	Anushka
52	Khushi Aundhkar	8767979519	khushiaundhkar52@gmail.com	Khushi
53	Nilrita Ekre	7972190515	ekrenilrita344@gmail.com	Nilrita
54	Shivani Bhute	9303900209	bhuteshivani895@gmail.com	Shivani
55	Raksha D. Dhote	7498511875	raakshadhote3@gmail.com	Raksha

Signature of:

Programme In-charge

COORDINATOR
INTERNAL QUALITY ASSURANCE CELL
DHARAMPETH, M. P. DEO MEMORIAL &
SCIENCE COLLEGE, NAGPUR

Principal

Dharampeth M.P. Deo Memorial
Science College, Nagpur.



DHARAMPETH M. P. DEO MEMORIAL SCIENCE COLLEGE,
North Ambazari Road, Near Ambazari Lake, Nagpur- 440033

DATA VALIDATION & VERIFICATION (DVV)

56	Ray Dipak Saedae	9765801822	raysaedae662002@gmail.com	Ray
57	Tarun Ponke	9422488044	tarunponke2002@	T.P.
58	Pratik R. Shete	9356716253	pratikshete193@	Pratik
59	Amanjeet Singh Chahal	9960071542	amanjeetchahal13@	Amanjeet
60	Gaurav P. Ekanekar	9665983780	Ekanekargaurav7@	G.P.
61	Safal Jaiswal	7219533166	SafalJaiswal2002@	S.J.
62	Sumeet Bhalekar	9021627757	Sumitbhalakar262@	S.Bhalekar
63	Pallavi Bhagat	9022654940	Pallavi2208@gmail.com	P.Bhagat
64	Sakshi Moon	7745827736	sakshim3030@gmail.com	S.Moon
65	Vinay R. Jaiswal	8788422101	vinay8788422101@gmail.com	Vinay

Signature of:

Programme In-charge

CO-ORDINATOR
INTERNAL QUALITY ASSURANCE CELL
DHARAMPETH, M. P. DEO MEMORIAL &
SCIENCE COLLEGE, NAGPUR

Principal
Dharampeth M.P. Deo Memorial
Science College, Nagpur.



DHARAMPETH M. P. DEO MEMORIAL SCIENCE COLLEGE,
North Ambazari Road, Near Ambazari Lake, Nagpur- 440033

DATA VALIDATION & VERIFICATION (DVV)

66	Prachi Suresh Manusman	9356969609	Prachi2020m@gmail.com	Pjgurumcke
67	Sakshi L. Barapatre	8317219372	Sakshi2002bb@gmail.com	Sakshi
68	Rishikesh R. Dhetke	8788199260	nishikeshdhetke2002@gmail.com	Dhetke
69	Himanshu. Lukhe	7448252469	himanshuorlakh08@gmail.com	Lukhe
70	Pranay Dhore	8830629245	pranaydhore97@gmail.com	Dhore
71	Divyani Dhule	887030731921	divyandhule2002@gmail.com	Dhule
72	Vaibhav Rane	7744951383	VaibhavRane2207@gmail.com	Rane
73	Uday Kandarakar	9545897196	udaykandarakar88@gmail.com	Kandarakar
74	Piyush Kapse	⁹³⁷³⁵⁶³⁰²⁷ 7448252469		
75	Pranav Galkwad	7083995899	PranavGalkwad@gmail.com	Galkwad
76	Piyush. G. Kapse	9375563027	Kapsepiyush03@gmail.com	Kapse

Signature of:

Programme In-charge



ICAC Coordinator
INTERNAL QUALITY ASSURANCE CELL
DHARAMPETH, M. P. DEO MEMORIAL &
SCIENCE COLLEGE, NAGPUR

Principal

Dharampeth M. P. Deo Memorial
Science College, Nagpur.



DHARAMPETH M. P. DEO MEMORIAL SCIENCE COLLEGE, NAGPUR
INTERNAL QUALITY ASSURANCE CELL (IQAC)
NEP Activity Report

Date: 18/10/2022

Name of Organizing Department or Committee: Chemistry

Name of the activity: NEP Activity Report (Sem I, paper II, Unit I-Thermodynamics)

Suggested CRITERION point if any: Criteria II

Date of Activity: 12-09-2022

Place of Activity: Department of Chemistry

Name of Guest Speaker/s or Judge/s or Chief Guest/s if any- Nil

Title of the Activity: Model making for irreversible system and model making for state function and path function

Number of Participants: 41

Name of the Teacher In-charge / Convener: Dr. Mrs. Yogita Morey (Dahire)

Names of other Committee Members / Staff: Dr. Mrs. V. P. Meshram

OUTCOME of the Activity with respect to mission vision of the institute and or academics:

This is a student's centric activity. Model making for irreversible system helps students to understand the concept of irreversible system visually. Water fall model showing irreversible system prepared by students describe how water fall is a natural and spontaneous process like irreversible process visually instead of theoretical studies. This can easily visualized and the students understanding and idea about irreversible system. Model for state function and path function prepared by students is a pyramid having three different paths showing to them peak of the pyramid. This model visually clears the concept of students about the state function and path function.



Activity with newspaper coverage if any: Nil

Activity data saved in PC of: Chemistry Department

Note: Kindly share Jio tag photographs separately along with report on igacdsc2022@gmail.com

Prof. Pitambar Humane
IQAC Coordinator

CO ORDINATOR
INTERNAL QUALITY ASSURANCE CELL
DHARAMPETH, M. P. DEO MEMORIAL &
SCIENCE COLLEGE, NAGPUR

Name & Signature of Teacher In-charge

Dr. Akhilesh Peshwe
Principal

PRINCIPAL

Dharampeth M.P. Deo Memorial
Science College, Nagpur-440023



DHARAMPETH M. P. DEO MEMORIAL SCIENCE COLLEGE,
North Ambazari Road, Near Ambazari Lake, Nagpur-440033

DATA VALIDATION & VERIFICATION (DVV)

Activity - 1 on Unit - 1
 Name of the Programme : Model making on irreversible system and state function & path function.
 Date of the Programme : 12-07-2022
 Name of Chief Guest if any :
 Name of Guest Speaker if any :

Sr. No.	Name of the Participant	Mobile Number	E-mail Id	Signature
1.	Ruchi divedi	8080776893	Ruchidivedi230@gmail.com	Ruchi
2.	Saurabh Chaudhary	9359883501	Schaudhary5599@gmail.com	Sas
3.	Ritika bhayar	9834587087	Ritikabhayar28@gmail.com	Ritika
4.	Monika I Patel	7499225468	MonikaPatel103@gmail.com	Monipatel
5.	Karishma N. Prasad	9309318667	narendraprasad79@gmail.com	Karishma
6.	Pratibha Bhusari	9821048413	bhusari78@gmail.com	PBB
7.	Shital O. Patle	9764596337	ShitalPatle@gmail.com	Shital
8.	Ankit Patel	9970905838	ankitpatel7972@gmail.com	Ankit
9.	Saurabh Chaudhary	9359883301	Schaudhary5599@gmail.com	Saurabh
10.	Shivam Patel	7038889083	Si040263@gmail.com	Shivam
11.	Devgesh K. Ghodmare	9075318618	devgeshghodmare001@gmail.com	Devgesh
12.	Pawan E. Thakkar	8262969113	thakkerpawan739@gmail.com	Paw
13.	Mumali D. Bhulker	9322727616	MumaliBhulkar@gmail.com	Mumali
14.	Nihal V. Mesharam	9322727616	Nihalmesharam@gmail.com	Nihal

Signature of:
 Programme in-charge

(Dr. Mrs. Jayita Moray (Dahiro))

CO ORDINATOR

INTERNAL QUALITY ASSURANCE CELL
 DHARAMPETH, M. P. DEO MEMORIAL &
 SCIENCE COLLEGE, NAGPUR

PRINCIPAL

Dharampeth M.P. Deo Memorial
 Science College, Nagpur-440033



DHARAMPETH M. P. DEO MEMORIAL SCIENCE COLLEGE,
North Ambazari Road, Near Ambazari Lake, Nagpur-440033

DATA VALIDATION & VERIFICATION (DVV)

15	Nikhil R. Kumare	8262969713	Nikhilkumare@gmail.com	Nks
16	Apeksha P Kotangale	9559455794	apekshakotangale26@gmail.com	A Kotangale
17	Pranali Chauhan	9699654562	Pranalic Chauhan 69@gmail.com	Pch Chauhan
18	Neha Wanjari	9373832266	neha.wanjari.733@gmail.com	N. Wanjari
19	Sumaira Chichande	8530970132	Sumaira Chichande@gmail.com	S Chichande
20	Ashlesha Khadgi	7820929579	Ashlesha Khadgi@gmail.com	Ashlesha
21	Kautilika Patole	9021533341	Kautilika Patole@gmail.com	K Patole
22	Gunjan Bhoyar	8668335876	gunjanbhoyar34@gmail.com	Gunjan
23	Gauri R. Bhoyar	7666799586	Gauribhoyar@gmail.com	Gauri
24	Vaishnavi Sonje	8421657945	Vaishnavi Sonje 2804@gmail.com	V Sonje
25	Maheshwari Bhakre	9092137975	Maheshwari Bhakre@gmail.com	M Bhakre
26	Aakansha Y. Mairal	8010923662	aakansha.y.mairal@gmail.com	A Y Mairal
27	Raj Meshram	9529727031	Raj Meshram 140@gmail.com	Raj
28	Khushi Bharti	9604367894	2003khushibharti@gmail.com	Khushi
29	Nikita Das	8446297880	NikitaDas970@gmail.com	N Das
30	Yachana Pandey	9156035297	Pandeykn54@gmail.com	Y Pandey
31	Priya Sharma	8010764549	priya21200ysharma@gmail.com	P Sharma
32	Nexha Pandey	8605231390	Abhishek 8605231390@gmail.com	N Pandey
33	Abhay P. Tombar	89575363145	abhay230102@gmail.com	A P Tombar
34	Lucky A. Vishwakarma	9579660186	lvishwakarma24@gmail.com	L Vishwakarma
35	Keeran K. Ghughuskar	902123167	Ghughuskar.ki@gmail.com	K Ghughuskar

Signature of:

Programme In-charge

Dr. Mrs. Yogita Moray (Dahire)

ICAQ Coordinator
COORDINATOR

INTERNAL QUALITY ASSURANCE CELL
DHARAMPETH M. P. DEO MEMORIAL &
SCIENCE COLLEGE, NAGPUR

Principal

PRINCIPAL

Dharampeth M. P. Deo Memorial
Science College, Nagpur-440033



DHARAMPETH M. P. DEO MEMORIAL SCIENCE COLLEGE,
North Ambazari Road, Near Ambazari Lake, Nagpur- 440033

DATA VALIDATION & VERIFICATION (DVV)

36	Dejal D. Kolhe	8483045985	Kolhe.dejal04@gmail.com	<i>[Signature]</i>
37	Riya Rajbhar	8600256951	riy.rajbhar18@gmail.com	<i>[Signature]</i>
38	Amisha Arkar	766559171	Arkar.amisha700@gmail.com	<i>[Signature]</i>
39	Aasiya S. Hussain	70664114118	Aasiyarahmani234@gmail.com	<i>[Signature]</i>
40	Ghanashree Shemone	8459807047	Ghanashree.shemone@gmail.com	<i>[Signature]</i>
41	Jeet S. Pardhi	7020215431	Jeet.s.pardhi111@gmail.com	<i>[Signature]</i>

Signature of: *[Signature]*
Programme in-charge

Dr Mrs. Yogita Morey (Dahore)

[Signature]

ICAC Coordinator
CO ORDINATOR
INTERNAL QUALITY ASSURANCE CELL
DHARAMPETH, M. P. DEO MEMORIAL &
SCIENCE COLLEGE, NAGPUR

[Signature]
PRINCIPAL

Dharampeth M. P. Deo Memorial
Science College, Nagpur-440033



DHARAMPETH M. P. DEO MEMORIAL SCIENCE COLLEGE, NAGPUR
INTERNAL QUALITY ASSURANCE CELL (IQAC)
NEP Activity Report

Date:18/10/2022

Name of Organizing Department or Committee: Chemistry

Name of the activity: NEP Activity Report (Sem I, paper II, Unit I-Thermodynamics)

Suggested CRITERION point if any: Criteria II

Date of Activity: 12-09-2022

Place of Activity: Department of Chemistry

Name of Guest Speaker/s or Judge/s or Chief Guest/s if any: Nil

Title of the Activity: Model making for Closed and Open system.

Number of Participants: 41

Name of the Teacher In-charge / Convener: Dr. Mrs. Yogita Morey (Dahire)

Names of other Committee Members / Staff: Dr. Mrs. V. P. Meshram

OUTCOME of the Activity with respect to mission vision of the institute and or academics:

This is a student's centric activity. Model making for open and closed system helps students to understand the concept of open and closed system visually. Water fall model showing irreversible system prepared by students describe how water fall is a natural and spontaneous process like irreversible process visually instead of theoretical studies. This can easily visualized and the students understanding and idea about irreversible system. Model for state function and path function prepared by students is a pyramid having three different paths .



Activity with newspaper coverage if any: Nil

Activity data saved in PC of: Chemistry Department

Note: Kindly share Jio tag photographs separately along with report on iqacdsc2022@gmail.com

Prof. Pitambar Humane
IQAC Coordinator

CO ORDINATOR
INTERNAL QUALITY ASSURANCE CELL
DHARAMPETH, M. P. DEO MEMORIAL &
SCIENCE COLLEGE, NAGPUR

Name & Signature of Teacher In-charge
(Yogita Morey (Dahire))

Dr. Akhilesh Peshwe
Principal

PRINCIPAL
Dharampeth M.P. Deo Memorial
Science College, Nagpur-440033



DHARAMPETH M. P. DEO MEMORIAL SCIENCE COLLEGE,
North Ambazari Road, Near Ambazari Lake, Nagpur-440033

DATA VALIDATION & VERIFICATION (DVV)

Name of the Programme : Activity - 1 on Unit - 1
Model making on closed system and open system.
Date of the Programme : 12-07-2022
Name of Chief Guest if any : _____
Name of Guest Speaker if any : _____

Sr. No.	Name of the Participant	Mobile Number	E-mail Id	Signature
1.	Ruchi dwivedi	8080776893	Ruchidwivedi230@gmail.com	Ruchi
2.	Saurabh Chaudhary	9359883501	Schaudhary5599@gmail.com	Sas
3.	Ritika bhayav	9834587087	RitikaBhayav28@gmail.com	Ritika
4.	Manika J. Patel	7499225468	ManikaPatel103@gmail.com	Mpatel
5.	Karishma N. Prasad	9309318667	narendraprasad7@gmail.com	Karishma
6.	Pratibha Bhusari	7821048413	bhusari78@gmail.com	PB
7.	Shital O. Patle	9764596337	ShitalPatle@gmail.com	@patle
8.	Ankit Patel	9970905838	ankitpatel7972@gmail.com	Apatle
9.	Saurabh Chaudhary	9359883301	Schaudhary5599@gmail.com	Saurabh
10.	Shivam Patel	7038889083	Si040263@gmail.com	Shivam
11.	Durgesh K Ghodmare	9075318618	durgeshghodmare00@gmail.com	Durgesh
12.	Pawan E. Thakare	8262969113	ThakarePawan737@gmail.com	PB
13.	Meenal D. Bhulkar	9322727616	MeenalBhulkar@gmail.com	Meenal
14.	Nihal V. Meshram	9322727616	Nihalmesharam@gmail.com	Nihal

Signature of: _____
Programme in-charge

(Dr. Mrs. Jagita Moray (Dahiro))

ICAC Coordinator

CO ORDINATOR
INTERNAL QUALITY ASSURANCE CELL
DHARAMPETH, M. P. DEO MEMORIAL &
SCIENCE COLLEGE, NAGPUR

Principal

PRINCIPAL
Dharampeth M.P. Deo Memorial
Science College, Nagpur-440033



DHARAMPETH M. P. DEO MEMORIAL SCIENCE COLLEGE,
North Ambazari Road, Near Ambazari Lake, Nagpur-440033

DATA VALIDATION & VERIFICATION (DVV)

15	Nikhil R. Kumare	8262969713	NikhilKumare@gmail.com	Rms
16	Apeksha D. Kotangale	9559455794	apekshadkotangale126@gmail.com	A Kotangale
17	Pranali Chauhan	9699654562	Pranalic Chauhan 69@gmail.com	Pch Chauhan
18	Neha Wanjari	9373832266	neha.wanjari 733@gmail.com	N Wanjari
19	Sunaina Chichande	8530970132	Sunaina Chichande@gmail.com	S Chichande
20	Ashlesha Khadgi	7820929579	Ashlesha Khadgi@gmail.com	Ashlesha
21	Kautilika Pokale	9021533341	Pokale Kautilika@gmail.com	K Pokale
22	Gunjan Bhoyar	8668335876	gunjanbhoyar 34@gmail.com	Gunjan
23	Gauri R. Bhoyar	7666799586	Gauri Bhoyar@gmail.com	Gauri
24	Vaishnavi Stange	8421657945	Vaishnavi Stange 2804@gmail.com	V Stange
25	Maheshwari Bhakre	9092137975	Maheshwari Bhakre@gmail.com	M Bhakre
26	Aakrushi Y. Mairal	8010923662	aakrushi y 2004@gmail.com	A Y Mairal
27	Raj Meshram	9529727031	Raj Meshram 140@gmail.com	Raj
28	Khushi Bharti	9604367894	2003khushi bharti@gmail.com	K Bharti
29	N. Kita Des	8446277880	N. Kita Des 970@gmail.com	N Des
30	Yashana Pandey	9156035297	Pandey Kn 54@gmail.com	Y Pandey
31	Priya Sharma	8010764549	Priya Sharma 2004@gmail.com	P Sharma
32	Nexha Pandey	8605231390	Abhishek 8605231390@gmail.com	N Pandey
33	Abhay P. Tombar	89575363145	abhay 230102@gmail.com	A P Tombar
34	Lucky A. Kishwarkar	9579660186	lucky.kishwarkar 2004@gmail.com	L Kishwarkar
35	Keeran K. Ghughuskar	902123167	Ghughuskar. K. on 2004@gmail.com	K Ghughuskar

Signature of:
Programme In-charge

Dr. Mrs. Yogita Moray (Dahire)

ICAE Coordinator
COORDINATOR

INTERNAL QUALITY ASSURANCE CELL
DHARAMPETH, M. P. DEO MEMORIAL &
SCIENCE COLLEGE, NAGPUR

Principal

PRINCIPAL

Dharampeth M. P. Deo Memorial
Science College, Nagpur-440033



DHARAMPETH M. P. DEO MEMORIAL SCIENCE COLLEGE,
North Ambazari Road, Near Ambazari Lake, Nagpur- 440033

DATA VALIDATION & VERIFICATION (DVV)

36	Sajal D. Kolhe	8483045985	kolhesajal04@gmail.com	Kolhe
37	Riya Rajbhar	8600256951	riyaraibhar18@gmail.com	RI
38	Amisha Patkar	7666559171	PatkarAmisha200@gmail.com	Amisha
39	Aasiya S Hussain	7066411418	Aasiyanshawari87@gmail.com	A Hussain
40	Ghaneshwar Dhemare	8459807047	ghaneshwarDhemare@gmail.com	Dhemare
41	Teet S. Pardhi	7020215431	TeetSpardhi111@gmail.com	Pardhi

Signature of: 
Programme In-charge
Dr. Mrs. Yogita Maray (Dahere)

IGAC Coordinator
CO ORDINATOR
INTERNAL QUALITY ASSURANCE CELL
DHARAMPETH, M. P. DEO MEMORIAL &
SCIENCE COLLEGE, NAGPUR

Principal
PRINCIPAL
Dharampeth M.P. Deo Memorial
Science College, Nagpur-440033



DHARAMPETH M. P. DEO MEMORIAL SCIENCE COLLEGE, NAGPUR
INTERNAL QUALITY ASSURANCE CELL (IQAC)
Activity Report

NEP Activity 2022-23

Date: 9/10/22

Name of Organizing Department or Committee: Department of Chemistry

Name of the activity: NEP Activity Sem V Unit IV

Suggested CRITERION point if any: Criterion II

Date of Activity: 13-09-2022

Place of Activity: Class room

Name of Guest Speaker/s or Judge/s or Chief Guest/s if any: _____

Title of the Activity: Name and listing of drugs used as anticancer and antibacterial agents (Unit IV)

Number of Participants: 41

Name of the Teacher In-charge / Convener: Dr Vaishali Meshram

Names of other Committee Members / Staff: Dr Deepika Brijpuriya, Dr Sandip Bhiwgade

OUTCOME of the Activity with respect to mission vision of the institute and or academics:

This is student centric activity. By this activity, students learn about drug composition. Medicinal properties like Antihistaminic, Analgesic, Antipyretic was also cleared to Students by this activity. They also learn about drug class and Dosage for the different types of medicine, the importance of expiry dates etc.



Activity with newspaper coverage if any: _____

Activity data save in PC of: Department of Chemistry

Note: Kindly share geotag photographs separately along with report on igacdsc2022@gmail.com

Prof. Pitambar Humane
IQAC Coordinator

CO ORDINATOR
INTERNAL QUALITY ASSURANCE CELL
DHARAMPETH, M. P. DEO MEMORIAL &
SCIENCE COLLEGE, NAGPUR

Name & Signature of Teacher In-charge

Dr. Akhilesh Peshwe
Principal

PRINCIPAL
Dharampeth M.P. Deo Memorial
Science College, Nagpur - 440013



DHARAMPETH M. P. DEO MEMORIAL SCIENCE COLLEGE,

North Ambazari Road, Near Ambazari Lake, Nagpur- 440033

DATA VALIDATION & VERIFICATION (DVV)

Name of the Programme : Name and listing of drugs used as anticancer and antibacterial agents
Date of the Programme : 13-09-2022
Name of Chief Guest if any : _____
Name of Guest Speaker if any : _____

Sr. No.	Name of the Participant	Mobile Number	E-mail Id	Signature
1.	Amit Walde	9302900209	walde10082002@gmail.com	Amit
2.	Anjali Namdeo Walde	7972190515	anjaliwalde85@gmail.com	Anu.
3.	Suhani Indulkar	7378312504	suhaindulkar@gmail.com	Suani
4.	Prachi Vaghate	7518090406	Vaghate31304@gmail.com	Prachi
5.	Nikita Purohit	9579642564	kundnikita@gmail.com	Purohit
6.	Shubham Khobragade	9518788915	shubhamkhobragade2001@gmail.com	Shubham
7.	Tshwar Suryawanshi	808737297	suryawanshiishwar@gmail.com	Shwar
8.	Neha Kawase	8766738340	neha2002kk@gmail.com	Neha
9.	Tejal A Montay	9322458697	tejal1123@gmail.com	Tejal
10.	Anjali Mishra	8379948166	am35869@gmail.com	Anjali
11.	Laxmi G Sayam	7517793675	SayamLaxmi359@gmail.com	Laxayam
12.	Muskan Sheikh	8055474633	Muskan201955@gmail.com	Muskan
13.	Sakshi Moon	7745827736	Sakshi2030@gmail.com	Sakshi
14.	Nikita Ekre	7972190515	ekre_nikita344@gmail.com	Nikita

Signature of: _____
Programme In-charge

Signature of: _____
CO ORDINATOR

INTERNAL QUALITY ASSURANCE CELL
DHARAMPETH, M. P. DEO MEMORIAL &
SCIENCE COLLEGE, NAGPUR

Signature of: _____
PRINCIPAL

Dharampeth M.P. Deo Memorial
Science College, Nagpur-441033



DHARAMPETH M. P. DEO MEMORIAL SCIENCE COLLEGE,
North Ambazari Road, Near Ambazari Lake, Nagpur- 440033

DATA VALIDATION & VERIFICATION (DVV)

15.	Aditi Bisen	8767484914		<u>ms</u>
16.	Aditi Dhole	8847709571	aditidhole4@gmail.com	<u>Ace</u>
17.	Harsh Singh	9011680573	harshsingh@gmail.com	<u>Snigdha</u>
18.	Meenali R. Sensari	9850163812	Sensarimeenali16@gmail.com	<u>P. Sensari</u>
19.	Neha A. Waghade	7249895144	nehawaghade1682002@gmail.com	<u>N. Waghade</u>
20.	Damini M. Banduche	8275105785	banduchedamini@gmail.com	<u>D. Banduche</u>
21.	Rakhi Gedam	7378312504	gedamrakhi2000@gmail.com	<u>R. Gedam</u>
22.	Prachi S. Waghale	8767914118	Prachiwaghale11@gmail.com	<u>P. Waghale</u>
23.	Pragya R. Jha	9665852975	PragyaRJT697@gmail.com	<u>P. Jha</u>
24.	Shrutika Pawar	8275705785	pawarshrutika@gmail.com	<u>Shrutika</u>
25.	Suhani Andulkar	7378312504	andulkar.suhani@gmail.com	<u>S. Andulkar</u>
26.	Muskan H. Sheikh	8055474633	Muskan2019555@gmail.com	<u>M. Sheikh</u>
27.	Bhumika D. Chedge	8886391103	bumikachedge@gmail.com	<u>B. Chedge</u>
28.	Khushi D. Andhkar	8767279513	Khushiandhkar652@gmail.com	<u>Khushi</u>
29.	Tanushree R. Date	8766927406	tanushreedate@gmail.com	<u>T. Date</u>
30.	Akansha R. Velure	8202935529	akanshavature@gmail.com	<u>Akansha</u>
31.	Vedika P. Karanekar	9155159387	Vedikakarankar@gmail.com	<u>V. Karanekar</u>
32.	Damini M. Banduche	8275105785	banduchedamini@gmail.com	<u>D. Banduche</u>
33.	Varshnavi Chandekar	7249882964	varshnavichandekar000@gmail.com	<u>V. Chandekar</u>
34.	Dirya Bondre	8668454925	diryabondre3@gmail.com	<u>Dirya</u>
35.	Snchal A. Bute	7058750570	snchalbute7218@gmail.com	<u>S. Bute</u>

Signature of:
Programme In-charge

ICAC Coordinator

INTERNAL QUALITY ASSURANCE CELL
DHARAMPETH, M. P. DEO MEMORIAL &
SCIENCE COLLEGE, NAGPUR

Principal

PRINCIPAL

Dharampeth M.P. Deo Memorial
Science College, Nagpur-440033



DHARAMPETH M. P. DEO MEMORIAL SCIENCE COLLEGE,
North Ambazari Road, Near Ambazari Lake, Nagpur-440033

DATA VALIDATION & VERIFICATION (DVV)

36.	Sayli S Lokhande	9356413804	sgyalilokhande@gmail.com	P Lokhande
37.	Rakhi Gedam	7878312804	gedamrathi2000@gmail.com	R Gedam
38.	Nikita Eke	7972190515	EkeNikita02@gmail.com	NEKA
39.	Aachal Wagh	9579663359	aacha.wagh.2003@gmail.com	A Wagh
40.	Roji Pathan	8669595798	Rojiphan66124@gmail.com	R Pathan
41.	Prachi Waghole	9767914118		<u> </u>

Signature of:
Programme In-charge

[Signature]
ICAC Coordinator
CO ORDINATOR
INTERNAL QUALITY ASSURANCE CELL
DHARAMPETH, M. P. DEO MEMORIAL &
SCIENCE COLLEGE, NAGPUR

[Signature]
PRINCIPAL
Dharampeth M.P. Deo Memorial
Science College, Nagpur-440033



DHARAMPETH M. P. DEO MEMORIAL SCIENCE COLLEGE, NAGPUR
INTERNAL QUALITY ASSURANCE CELL (IQAC)

Activity Report

NEP Activity 2022-23

Date: 14/09/2022

Name of Organizing Department or Committee: Department of Chemistry

Name of the activity: NEP Activity

Suggested CRITERION point if any: Criterion II

Date of Activity: 13-09-2022

Place of Activity: Chemistry Laboratory

Name of Guest Speaker/s or Judge/s or Chief Guest/s if any: Chemistry Lab

Title of the Activity: Demonstration of Rayon polymers (Unit IV) *Paper II*

Number of Participants: 56

Name of the Teacher In-charge / Convener: Dr Deepika Brijpuriya

Names of other Committee Members / Staff: Dr Vaishali Meshram

OUTCOME of the Activity with respect to mission vision of the institute and or academics:

This student Centric activity. This activity helps the students about the wide applications of synthetic polymer. With the live demonstration of Rayon synthesis, students learn handling of different chemicals for the preparation of Rayon. Rayon fabric is manufactured using purified cellulose obtained from wood pulp.



Activity with newspaper coverage if any: _____

Activity data save in PC of: Department of Chemistry

Note: Kindly share geotag photographs separately along with report on iqacdsc2022@gmail.com

Prof. Pitambar Humane
IQAC Coordinator
CO ORDINATOR
INTERNAL QUALITY ASSURANCE CELL
DHARAMPETH, M. P. DEO MEMORIAL &
SCIENCE COLLEGE, NAGPUR

Dr. Deepika Brijpuriya
Name & Signature of Teacher in-charge

Dr. Akhilesh Peshwe
Principal
PRINCIPAL

Dharampeth M.P. Deo Memorial
Science College, Nagpur-440033



DHARAMPETH M. P. DEO MEMORIAL SCIENCE COLLEGE,
North Ambazari Road, Near Ambazari Lake, Nagpur-440033

DATA VALIDATION & VERIFICATION (DVV)

Name of the Programme : Demonstration of Rayon polymer (NEP Activity)
Date of the Programme : _____
Name of Chief Guest if any : _____
Name of Guest Speaker if any : _____

Sr. No.	Name of the Participant	Mobile Number	E-mail Id	Signature
1.	Damini M. Bandbuche	8275105785	bandhuchedomini@gmail.com	<u>Damini</u>
2.	Supriya Patle	7751871925	Patlesupriya021@gmail.com	<u>Patle</u>
3.	Anjali Charde	8261964188	anjali charde 20@gmail.com	<u>Anjali</u>
4.	Akansa S. Bhute	9356964121	akanshabhute2020@gmail.com	<u>Akansa</u>
5.	Priyanka L. Auywar	9579263881	Priyankagujwar2020@gmail.com	<u>Priyanka</u>
6.	Sonam Uprade	9890230462	sonamuprade@gmail.com	<u>Sonam</u>
7.	Rakhi Gedam	7378312504	gedamrakhi2000@gmail.com	<u>Rakhi</u>
8.	Arshuman Sharma	9370892262	arshumansharma814@gmail.com	<u>Arshuman</u>
9.	Vishal Kumar Singh	9610187223	singhvishal962@gmail.com	<u>Vishal</u>
10.	Prachi K. Varabhe	9325336932	Prachivarabhe@gmail.com	<u>Prachi</u>
11.	Dolly B. Gabhane	9284269236	dollygabhane2@gmail.com	<u>Dolly</u>
12.	Sushila Puati	2247882964	sushilapuoti224@gmail.com	<u>Sushila</u>
13.	Varshnavi R. Chandekar	7507439390	varshnavichandekar@gmail.com	<u>Varshnavi</u>
14.	Pallavi Y. Bhagat	902265-4940	Pallavim2208@gmail.com	<u>Bhagat</u>

Signature of: [Signature]
Programme in-charge

IQAC Coordinator

CO ORDINATOR

INTERNAL QUALITY ASSURANCE CELL
DHARAMPETH, M. P. DEO MEMORIAL &
SCIENCE COLLEGE, NAGPUR

Principal

PRINCIPAL

Dharampeth M.P. Deo Memorial
Science College, Nagpur-440033



DHARAMPETH M. P. DEO MEMORIAL SCIENCE COLLEGE,
North Ambazari Road, Near Ambazari Lake, Nagpur- 440033

DATA VALIDATION & VERIFICATION (DVV)

15.	Anushka S Das	9858932157	ada4092001@gmail.com	<u>Adas</u>
16.	Akansha R. Yelure	8767935524	akansha.yelure@gmail.com	<u>Akansha</u>
17.	Chatali M. Bumbade	9359540894	chatali2020@gmail.com	<u>Chatali</u>
18.	Pragya R Jha	9665852975	pragya697@gmail.com	<u>Jha</u>
19.	Muskan Sheikh			<u>M. Sheikh</u>
20.	Tanushree Date			<u>Date</u>
21.	Kartik Adlakhia	8580597159	kartikadlakhia@gmail.com	
22.	Chetan Kamthe	9637271601	kamthechetan@gmail.com	<u>Kamthe</u>
23.	Kaustubh Ramteke	7218487714	ramtekekaustubh2002@gmail.com	<u>Ramteke</u>
24.	Shubham K hobnagade	9578788915	shubhamkhobnagade2001@gmail.com	<u>Shubham</u>
25.	Tishwan Suryawanshi	8087317297	suryawanshitishwan@gmail.com	<u>Tishwan</u>
26.	Arpita T Dakhole	8010866758	arpitadakhole@gmail.com	<u>Dakhole</u>
27.	Jayashree D. Hiwase	7385473157	juhikware10@gmail.com	<u>J. D. Hiwase</u>
28.	Neha Waghade	8766738340	neha2002kk@gmail.com	
29.	Mrunali Somsare	9850163812	sonsaemrunalika@gmail.com	
30.	Neha Kawase	8766738340	neha2002kk@gmail.com	
31.	Amisha R. Ande	8767618394	adili123@gmail.com	<u>Ande</u>
32.	Tejal A Mankar	9322458697	tejal.mankar933@gmail.com	<u>Tejal</u>
33.	Laxmi G Sayam	7517793675	sayamlaxmi358@gmail.com	<u>Laxmi</u>
34.	Anjali Mehta	8379948166	am35869@gmail.com	<u>Anjali</u>
35.	Vaishnari R. Chandekar	9247882964	vaishnarichandekar@gmail.com	<u>Chandekar</u>

Signature of: [Signature]
Programme In-charge

Signature of: [Signature]
CO-ORDINATOR
INTERNAL QUALITY ASSURANCE CELL
DHARAMPETH, M. P. DEO MEMORIAL &
SCIENCE COLLEGE, NAGPUR

Signature of: [Signature]
PRINCIPAL
Dharampeth M. P. Deo Memorial
Science College, Nagpur-44



DHARAMPETH M. P. DEO MEMORIAL SCIENCE COLLEGE,
North Ambazari Road, Near Ambazari Lake, Nagpur- 440033

DATA VALIDATION & VERIFICATION (DVV)

36.	Balraj Welda			Bhilda
37.	Nitin Harinkhede	9307723308	nikitarahangdale2005@gmail.com	N Rahangdale
38.	Pratham Gupta			Pratham
39.	Mukesh Oraon			Mukesh
40.	Nikita Rahangdale	9307723308	nikitarahangdale2005@gmail.com	N Rahangdale
41.	Priyanshi P Singh	7219259020	priyanshisingh1509@gmail.com	P Singh
42.	Suraj B. Shende			Suraj
43.	Akash. Ashok SPKdar	9175422051	sikdarakash15@gmail.com	A. Kash
44.	Sahil B. Shende	7507999221	Sahilgkoteswar@gmail.com	Sahil
45.	Shivam. S. Maurya			S
46.	Asha Ladge			Asha
47.	Aishwarya Jashi		aishwaryajashi@gmail.com	Aishwarya
48.	Pranjwal Mangle			P
49.	Tanmay Chaudhari	8600102361	tchaudhari S600@gmail.com	Ta
50.	Tanmay Gupta Bhatnagar	9697250231	tanmaybhatnagar900@gmail.com	Tanmay
51.	Nandini			Nandini
52.	Bhargavi Sambhare			Bhargavi
53.	Avanti Chaphekar	7875173847	avanti1011@gmail.com	Avanti
54.	Anushree Nele			Anushree
55.	Rupesh Wadde			Rupesh
56.	Rani Patel	8669595198	Ranipatel2404@gmail.com	Rani

Signature of:
Programme In-Charge

IQAC COORDINATOR
INTERNAL QUALITY ASSURANCE CELL
DHARAMPETH, M. P. DEO MEMORIAL &
SCIENCE COLLEGE, NAGPUR

PRINCIPAL
Dharampeth M.P. Deo Memorial
Science College, Nagpur-440033



DHARAMPETH M.P. DEO MEMORIAL SCIENCE COLLEGE, NAGPUR
ROTARACT CLUB OF DMPDSVM
Activity Report

Date: 30/09/2022

Name of Organizing Department or Committee: Rotaract Club

Name of the activity: Guest Lecture on Graphology

Suggested CRITERION point if any: Criterion III & Criterion V

Date of Activity: 15 September 2022

Place of Activity: College

Name of Guest Speaker/s or Judge/s or Chief Guest/s if any: Mrs. Sayli Dharashivkar

Title of the Activity: Guest Lecture on Graphology

Number of Participants: 42

Name of the Teacher In-charge/Convener: Dr. Mrs. Shraddha Deshpande

Names of other Committee Members/Staff: Rotaract Club Members

OUTCOME of the Activity with respect to mission vision of the institute and or academics:

The activity involved Handwriting analysis which is an effective and reliable indicator of personality and behavior and these features and interpretations provide a small but useful guide as to the way people behave, and particularly how they can revise their approach to better their academic learning.

Activity with newspaper coverage if any: Nil

Activity data save in PC of: Department of English



Prof. Pitambar Humane

IQAC Coordinator

CO ORDINATOR

INTERNAL QUALITY ASSURANCE CELL
DHARAMPETH, M. P. DEO MEMORIAL &
SCIENCE COLLEGE, NAGPUR

Dr. Mrs. Shraddha Deshpande
Teacher In-charge

Dr. Akhilesh Peshwe
Principal
Dharampeth M.P. Deo Memorial
Science College, Nagpur.



DHARAMPETH M.P.DEO MEMORIAL SCIENCE COLLEGE, NAGPUR

ROTARACT CLUB 22-23

Guest lecture on Graphology

15th September 2023

Rotary.org Link:





DHARAMPETH M. P. DEO MEMORIAL SCIENCE COLLEGE,
North Ambazari Road, Near Ambazari Lake, Nagpur- 440033

DATA VALIDATION & VERIFICATION (DVV)

Name of the Programme : Guest Lecture on Graphology

Date of the Programme : 15th Sept 2022

Name of Chief Guest if any : Mrs. Jayali Dharamshikar (Graphologist)

Name of ^{Co-ordinators} Guest Speaker if any : Dania Raza Madkit, Brajwal Bhojar

Sr. No.	Name of the Participant	Mobile Number	E-mail Id	Signature
①	Khushi Pali	8767607224	PaliKhushi4@gmail.com	
②	Nikita Barapatre	7058625053	Ruachibarapatre@gmail.com	
③	Ashlesha Sangale	9503998469	Ashleshasangale99@gmail.com	
④	Simran Dhimal	7666830683	simrandhimal20@gmail.com	
5)	Umang Warthi	9322428500	umangwarthi@gmail.com	
6)	Ritika Sondhiya	9175581655	ritika_sondhiya@gmail.com	
7)	Mahi Thaware	9960629566	thawaremahit7@gmail.com	
8)	Shruti Tiwari	8087143696	shrutitwari0721@gmail.com	
9)	Muskan Kulkarni	9156889239	muskan.kulkarni9@gmail.com	
10)	Katika Deshmukh	9699720960	KatikaDesm20@gmail.com	

Signature of:

Programme In-charge

ICAAC COORDINATOR
INTERNAL QUALITY ASSURANCE CELL
DHARAMPETH, M. P. DEO MEMORIAL &
SCIENCE COLLEGE, NAGPUR

Principal
Dharampeth M.P. Deo Memorial
Science College, Nagpur.



DHARAMPETH M. P. DEO MEMORIAL SCIENCE COLLEGE,
North Ambazari Road, Near Ambazari Lake, Nagpur-440033

DATA VALIDATION & VERIFICATION (DVV)

11	Arishka. A. Bhusod	7570841788	arishka.bhusod02@gmail.com	A.A.Bhusod
12	Uineet.M.Singh	7558426949	SinghUineet78524@gmail.com	Uineet
13	Vaishnavi V. Gadge	9022976449	gadgavaishnavi00@gmail.com	Vgadg
14	SAHIL SINGH	7258768802	sahilbansingh06@gmail.com	Sahil
15	Harshad warthi	7414993575	harshadwarthi9592@gmail.com	Harshad
16	Rutika Yadav	8446085943	yadavrutika434@gmail.com	Rutika
17.	Veena Borikar	9322016921	veenaborikar10@gmail.com	Veena
18.	Sakshi Mishra	9158788969	Smishra930683@gmail.com	Sakshi
19.	Vaishali Turkar	9373650950	Vaishaliturkar433@gmail.com	Vaishali
20.	Pradnya Tarpude	8010362232	pradnyatarpude9143@gmail.com	Pradnya
21.	Jankvi Joge	7885060871	Jankvi.joge@gmail.com	Jankvi
22	Jankvi Laibex	8446510589	Jankvilaibex@gmail.com	Jankvi
23	Mohit Khindekar	8055928357	Mohit.khindekar@gmail.com	Mohit
24	Pranali Aupta	7020069377	pranali1537@gmail.com	Pranali
25)	Jagmeti Fullcewar	8767911307	jagmetifullcewar@gmail.com	Jagmeti

Signature of:

Programme In-charge

CO-ORDINATOR
INTERNAL QUALITY ASSURANCE CELL
DHARAMPETH M. P. DEO MEMORIAL &
SCIENCE COLLEGE, NAGPUR

Principal

Dharampeth M.P. Deo Memorial
Science College, Nagpur.



DHARAMPETH M. P. DEO MEMORIAL SCIENCE COLLEGE,
North Ambazari Road, Near Ambazari Lake, Nagpur- 440033

DATA VALIDATION & VERIFICATION (DVV)

26)	Sonia Niwale	7058425021	niwalsonia70@gmail.com	Sonia Niwale
27)	Devashri Kekole	9021344265	devashrikekole@gmail.com	D. P. Kekole
28)	Manu Patil	7350450279	manu735045@gmail.com	Manu Patil
29)	Gendral Machode	9112142728	Nikhil machode@gmail.com	Ashwini
30)	Aman S. Kaur	9028837552	kaur7817@gmail.com	Aman S. Kaur
31)	Vibhanshu Taino	9561232204	VibhanshuTaino@gmail.com	Vibhanshu Taino
32)	Priyanshu Singh	9527710380	Priyanshusinghji0012@gmail.com	Priyanshu Singh
33)	Tejas Dongre	9322578518	Tej98754@gmail.com	Tejas Dongre
34)	Rehul Pandey	8776788703	DP9356521@gmail.com	Rehul Pandey
35)	Badal G. Somkuwar	7448247750	badalsomkuwar1@gmail.com	Badal G. Somkuwar
36)	Tushal Achare	9075995617	achuetushal5@gmail.com	Tushal Achare
37)	Vedant O. Ussetkar	9049932753	ussetkarvedant@gmail.com	Vedant O. Ussetkar
38)	Mahesh D. Pawde	9112875110	pawde mahesh77@gmail.com	M. Pawde
39)	Bhagyashali D. Neware	7796434177	sakshineware2017@gmail.com	B. D. Neware
40)	Samiksha A. Panchbudhe	9763075890	samikshapanchbudhe363@gmail.com	Samiksha Panchbudhe

Signature of:

Programme In-charge

CO ORDINATOR
INTERNAL QUALITY ASSURANCE CELL
DHARAMPETH, M. P. DEO MEMORIAL &
SCIENCE COLLEGE, NAGPUR

Principal
Dharampeth M.P. Deo Memorial
Science College, Nagpur.



DHARAMPETH M. P. DEO MEMORIAL SCIENCE COLLEGE,
North Ambazari Road, Near Ambazari Lake, Nagpur-440033

DATA VALIDATION & VERIFICATION (DVV)

41)	Prachi Pawedhi	7263935912	prachipawedhi282@gmail.com	Prachi
42)	Isha Waghmare	8855919474	ishawaghmare9474@gmail.com	Isha

Signature of:

Programme In-charge



CO-ORDINATOR
IQAC Coordinator
INTERNAL QUALITY ASSURANCE CELL
DHARAMPETH, M. P. DEO MEMORIAL &
SCIENCE COLLEGE, NAGPUR

Principal
Dharampeth M.P. Deo Memorial
Science College, Nagpur.



DHARAMPETH M. P. DEO MEMORIAL SCIENCE COLLEGE, NAGPUR
INTERNAL QUALITY ASSURANCE CELL (IQAC)

Activity Report Date: 30/09/2022

Name of Organizing Department or Committee: Home Science Department

Name of the activity: Three day Ceramic Workshop

Suggested CRITERION point if any: Criteria II & V

Date of Activity: 16/09/2022, 19/09/2022 and 20/09/2022

Place of Activity: Classroom

Name of Guest Speaker/s or Judge/s or Chief Guest/s Resource Person if any: Mrs. MenakshiKhangar.

Title of the Activity: Ceramic Workshop

Number of Participants: 13 students of BHsc Semester 1

Name of the Teacher In-charge / Convener: Ms. AnkitaWankhede

Names of other Committee Members / Staff: Mrs. Manju Deshpande

OUTCOME of the Activity with respect to mission vision of the institute and or academics:

1. They learn to create something new.
2. This activity builds confidence in students they can start her own small business and generate employment.
3. From this workshop students learn about the elements of art, relation of colour combination.

Activity with newspaper coverage if any: _____

Activity data save in PC of: Home Science Staff Room Desktop

Note: Kindly share geotag photographs separately along with report on iqacdsc2022@gmail.com



Ankita

Prof. Pitambar Humane
CO ORDINATOR
INTERNAL QUALITY ASSURANCE CELL
DHARAMPETH, M. P. DEO MEMORIAL &
SCIENCE COLLEGE, NAGPUR

Name & Signature of Teacher In-charge

Akhillesh

Dr. Akhilesh Peshwe
PRINCIPAL

Dharampeth M.P. Deo Memorial
Science College, Nagpur-440033

DHARAMPETH M P DEO MEMORIAL SCIENCE

DEPARTMENT OF HOME SCIENCE

NOTICE

All the Students are informed that organizing Three day Workshop on Ceramic Article for B.Sc Home Science Semester 1st Students. Workshop is arranged in Home Science Department on 16/09/2022, 19/09/2022 to 20/09/2022. Attendance is mandatory. Mode of programme is offline/online.



Name of Teacher Incharge

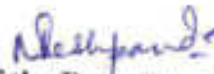

Head of the Department

To,

The HOD of Home Science Department

Dharampeth M.P. Deo Memorial

Science College Nagpur.

Date :- 3/9/2022

Subject: Request for conducting Ceramic workshop for B.Sc Home Science Semester I students.

Respected Madam,

This is to request you to please grant us permission for conducting ceramic workshop for B.Sc Home Science Semester I students on 15/09/2022 to 17/09/2022.

Hope you will grant us permission for the above.

Thanking You,

Yours Sincerely,

Ankita

Miss. Ankita Wankhede

Seen ; Acknowledged
Meshyande
2.09.22

PRINCIPAL
Dharampeth M.P. Deo Memorial
Science College, Nagpur-440033

Ceramic Workshop Date:- 16/9/2022

19/9/2022
20/9/2022



DHARAMPETH M. P. DEO MEMORIAL SCIENCE COLLEGE,
North Ambazari Road, Near Ambazari Lake, Nagpur- 440033

DATA VALIDATION & VERIFICATION (DVV) First Sem (Ist sem)

Sr.No.	Name	Mob.No.	E-mail.	Sign.
1	Neha R. Vishwakarma	8975846970		Neha.
2)	Shalu P. Poydhi	8329115380		Shalu.
3)	Bhavana A. Gurusudhani	8888437303	bhavangurusudhani@gmail.com	Bhavana
4)	Hemlata D. Verma	4514058379	varmahemlata9576@gmail.com	H. Verma
5)	Anshikha U. Jaiswarikar	9021391207	anshikhajaiswarikar@gmail.com	Anshikha
6)	Neha L. Gurusaut	9067167848	Nehagurusaut@gmail.com	Neha
7)	Gayatri N. Varma	9763987531		Gayatri
8)	Minal D. Patle	7330730164		Minal
9)	Shubhangi R. Nishad	9518534076	shubhnishad2510@gmail.com	Shubhangi
10)	Parna J. Chaudhari	7620384149		Chaudhari
11)	Aditi R. Vaidya	9075714591	aditivaidya619@gmail.com	Aditi
12)	SAKSHI R. CHAKUNDE	07843068801	SAKSHICHAKUNDE@gmail.com	Sakshi
13)	Aanchal D. Kokande	9309560449	achalkokande28@gmail.com	Aanchal

Signature of:

Ankita P. Wankhede

Programme In-charge

(Signature)

(Signature)
COORDINATOR
INTEGRATED QUALITY ASSURANCE CELL
DHARAMPETH, M. P. DEO MEMORIAL &
SCIENCE COLLEGE, NAGPUR

(Signature)
Principal

Dharampeth M. P. Deo Memorial
Science College, Nagpur-440033



DHARAMPETH M.P. DEO MEMORIAL SCIENCE COLLEGE, NAGPUR
ROTARACT CLUB OF DMPDSVM

Activity Report

Date: 30/09/2022

Name of Organizing Department or Committee: ROTARACT CLUB OF DMPDSVM

Name of the activity: Traffic awareness programme by NMC

Suggested CRITERION point if any: Criterion III & Criterion V

Date of Activity: 16 September 2022

Place of Activity: College Premises

Name of Guest Speaker/s or Judge/s or Chief Guest/s if any: Nil

Title of the Activity: Traffic awareness programme by NMC

Number of Participants: 65

Name of the Teacher In-charge/Convener: Dr. Mrs. Shraddha Deshpande

Names of other Committee Members / Staff: Rotaract Club Members

OUTCOME of the Activity with respect to mission vision of the institute and or academics:

Activity with newspaper coverage if any:

Activity data save in PC of: Department of English



Prof. Pitambar Humane
IQAC Coordinator
CO ORDINATOR
INTERNAL QUALITY ASSURANCE CELL
DHARAMPETH, M. P. DEO MEMORIAL &
SCIENCE COLLEGE, NAGPUR

Dr. Mrs. Shraddha Deshpande
Teacher In-charge

Dr. Akhilesh Peshwe
Principal
Dharampeth M.P. Deo Memorial
Science College, Nagpur.



DHARAMPETH M.P.DEO MEMORIAL SCIENCE COLLEGE, NAGPUR

ROTARACT CLUB 22-23

Traffic Awareness Pogramme

16 September 2022

Rotary.org Link:





DHARAMPETH M. P. DEO MEMORIAL SCIENCE COLLEGE,
North Ambazari Road, Near Ambazari Lake, Nagpur- 440033

DATA VALIDATION & VERIFICATION (DVV)

Name of the Programme : Seminar "Newly Designed App on "Traffic Awareness"

Date of the Programme : 16th September 2022

Name of Chief Guest if any : -

Name of Guest Speaker if any : Hilesh Kolharkar

Sr. No.	Name of the Participant	Mobile Number	E-mail Id	Signature
1)	Kajal Prasad	9410763138	prasad.kajal2006@gmail.com	
2)	Mansi Badale	7796308467	Mansi.badale@gmail.com	
3)	Shital R. Kelzarkar	9673385046	shital2020k@gmail.com	
4)	Divya K. Hanote	8605422901	divyahanote0406@gmail.com	
5)	Apuva S. Venutkar	9823613911	apuva.venutkar@gmail.com	
6)	Jitendra G. Patane	9657459925	Jitendra.patane296@gmail.com	
7)	Kavita Mishra	9657199261	km732889@gmail.com	
8)	Nikita J. Kallo	9067324988	kallenikitas@gmail.com	
9)	Sejal P. Lakshampal	9028851568	sejallakshampal@gmail.com	
10)	Aditya Mishra	7218484186	adityamishra2003@gmail.com	

Signature of:

Programme In-charge

CO ORDINATOR
INTERNAL QUALITY ASSURANCE CELL
DHARAMPETH, M. P. DEO MEMORIAL &
SCIENCE COLLEGE, NAGPUR

Principal
Dharampeth M.P. Deo Memorial
Science College, Nagpur



DHARAMPETH M. P. DEO MEMORIAL SCIENCE COLLEGE,
North Ambazari Road, Near Ambazari Lake, Nagpur-440033

DATA VALIDATION & VERIFICATION (DVV)

1)	Gargi Hodge	7912076671	gargihodge@gmail.com	Gargi
12)	Renuka Lande	7719951401	renukalande@	Renuka
13)	Dharmapuri Tale	9915037356	dharmapurihtraje@gmail.com	Dharmapuri
14)	Harsh Kedarpe	9604677672	harshkedarpe@gmail.com	Harsh
15)	Prajwal bhoyar	801434634	Prajwalb738@gmail.com	Prajwal
16)	Edam Pali	8530155796	edampali2002@gmail.com	Edam
17)	Tejas G. Salunke	7020730670	tejasgalsunke2008@gmail.com	Tejas
18)	Aditi Lute	7820812303	aditilute19@gmail.com	Aditi
19)	Trishabh saha	7385310571	trishabhsaha2004@gmail.com	Trishabh
20)	Pranali Dehankar	8767581278	Pdehna@gmail.com	Pranali P D
21)	Khushi Pali	8767607224	Palikhushi@gmail.com	Khushi
22)	Kashish Bisen	7887886117	kashishbisen05@gmail.com	K. Bisen
23)	Neha R. Vishwakarma	9975846970		Neha
24)	Khushi Pali	8459565214	palikhushib59@gmail.com	Khushi
25)	Ananya R. Motghare	7219218955	ananya.motghare2002@gmail.com	Ananya
26)	Vireet. M. Singh	7558426949	Vireetvireet78524@gmail.com	Vireet

Signature of:

Programme In-charge

CO ORDINATOR
INTERNAL QUALITY ASSURANCE CELL
DHARAMPETH, M. P. DEO MEMORIAL
SCIENCE COLLEGE, NAGPUR

Principal
Dharampeth M.P. Deo Memorial
Science College, Nagpur.



DHARAMPETH M. P. DEO MEMORIAL SCIENCE COLLEGE,
North Ambazari Road, Near Ambazari Lake, Nagpur-440033

DATA VALIDATION & VERIFICATION (DVV)

27)	Sania Midhat Raza	8975726700	midhatsania@gmail.com	Alaya
27)	Nupur. H. Sharma	8822042259	nupurchootma258@gmail.com	H. Sharma
29)	Kajal P. Nighat	9373250629	KajalNighat2000@gmail.com	Kajal Nighat
30)	Manasi S. Fating	8767154686	manasifating2110@gmail.com	Manasi Fating
31)	Asmin. K. Sheikh	8668323568	asmin029@gmail.com	Asmin K. Sheikh
32)	Kunal S Digsekar	8010274303	kunaldigsekar74@gmail.com	Kunal S Digsekar
33)	Omkumar D. Devangan	9763624388	Ommamaji12@gmail.com	Omkumar D. Devangan
34)	Bhumika V. Thakre	7218247917	Bhumikathakre65@gmail.com	Bhumika V. Thakre
35)	Jasraj D. Paliwal	9376820325	jasrajpaliwal@gmail.com	Jasraj D. Paliwal
36)	Harshad Wadhwa	7414993575	harshadwadhwa3192@gmail.com	Harshad Wadhwa

Signature of:

Programme in-charge

CO ORDINATOR
INTERNAL QUALITY ASSURANCE CELL
DHARAMPETH M. P. DEO MEMORIAL &
SCIENCE COLLEGE, NAGPUR

Principal
Dharampeth M. P. Deo Memorial
Science College, Nagpur.



DHARAMPETH M. P. DEO MEMORIAL SCIENCE COLLEGE, NAGPUR

INTERNAL QUALITY ASSURANCE CELL (IQAC)

Activity Report

(NEP-2022-23)

Date: 16/09/2022

Name of Organizing Department or Committee: Zoology

Name of the activity: Visit and live demonstration of pond ecosystem in college campus.

Suggested CRITERION point if any: Criteria 1

Date of Activity: 16/09/2022

Place of Activity: Fish culture Pond in college campus

Name of Guest Speaker judge/s or Chief Guest/s if any: Dr. Kishor T. Waghmare

Title of the Activity: Visit and live demonstration of pond ecosystem in college campus.

Number of Participants: 31

Name of the Teacher In-charge / Convener: Dr. K. M. Paturkar, Dr. K. T. Waghmare

Names of other Committee Members / Staff: Dr. K. M. Paturkar students of Zoological Society

OUTCOME of the Activity with respect to mission vision of the institute and or academics:

- Students get knowledge of Pond ecosystem and its importance.
- It has been better understood by visiting to the pond located in college campus.
- Students understand the importance of the biotic and abiotic components
- This activity helps students to get involved in the conservation strategy and decision making.

Activity with newspaper coverage if any: NIL

Activity data save in PC of: Zoology Department/personal laptop



[Signature]
Dr. Kirti Paturkar *[Signature]*
(Dr. K. T. Waghmare)

Name & Signature of Teacher In-charge

**DEPARTMENT OF ZOOLOGY,
DHARAMPETH M. P. DEO MEMORIAL
SCIENCE COLLEGE, NAGPUR**

[Signature]

Prof. Pitambar Humane

IQAC Coordinator

**CO ORDINATOR
INTERNAL QUALITY ASSURANCE CELL
DHARAMPETH, M. P. DEO MEMORIAL &
SCIENCE COLLEGE, NAGPUR**

[Signature]

Dr. Akhilesh Peshwe

Principal

Principal

**Dharampeth M. P. Deo Memorial
Science College, NAGPUR.**



DHARAMPETH M. P. DEO MEMORIAL SCIENCE COLLEGE,
North Ambazari Road, Near Ambazari Lake, Nagpur- 440033

DATA VALIDATION & VERIFICATION (DVV)

Name of the Programme : Visit and live demonstration of pond ecosystem in college campus.
Date of the Programme : 16/09/2022
Name of Chief Guest if any : _____
Name of Guest Speaker if any : Dr. Kishor T. Waghmare.

Sr. No.	Name of the Participant	Mobile Number	E-mail Id	Signature
1.	Pranali Y. Chavhare	9699652562	pranali.chavhare65@gmail.com	
2.	Kiran K. Ghughuskar	9823710569	ghughuskar.kirana004@gmail.com	
3.	Pratiksha Meshram	8459070338	meshrampratiksha01@gmail.com	
4.	Neha L. Wanjar	9313882266	nehawanjar733@ymail.com	
5.	Vaidhi P. Thote	7558499898	Vaidhi.thote29@gmail.com	
6.	Chanchal K. Waghwan	7796016894	waghwanchanchal@gmail.com	
7.	Krutika Pakale	9021533341	Pakalekrutika6@gmail.com	
8.	Ritika Sandliya	9175581655	Ritika.sandliya@gmail.com	
9.	Umang Warthi	9322428500	Umangwarthi@gmail.com	
10.	Amisha D. Aokar	7666559171	Aokaramisha70@gmail.com	
11.	Riya Rajbhar	8600256951	riyaraajbhar18@gmail.com	
12.	Jeet Pardhi	7020215431	jeet.pardhi11@gmail.com	
13.	Sampak Hadke	7020171304	sampakhadke3@gmail.com	
14.	Rohan Meshram	7499956761	rohanmeshram69@gmail.com	

Signature of:
Programme In-charge

IQAC Coordinator
IQAC Co-ordinator

Dharampeth M. P. Deo Memorial
Science College, Nagpur-440033

Principal
Principal

Dharampeth M. P. Deo Memorial
Science College, Nagpur



DHARAMPETH M. P. DEO MEMORIAL SCIENCE COLLEGE,
North Ambazari Road, Near Ambazari Lake, Nagpur-440033

DATA VALIDATION & VERIFICATION (DVV)

Sr. No.	Name of the Participant	Mobile Number	E-mail Id	Signature
15	Priya Sharma	8010964549	priya19012004.sharma@gmail.com	
16	Ghanshree U. Dhomane	8459807047	ghanshreedhomane@gmail.com	
17	Abhay Tembhare	8975303145	abhay23.0102@gmail.com	
18	Yachana Pandey	9156035297	ppandeyken54@gmail.com	
19	Ashalesha Khadgi	8830414264	Ashalesha.khadgi25@gmail.com	
20	Sunaina Chichonde	8530970132	Sunainachichonde@gmail.com	
21	Shruti Channekar		shruti.channekar@gmail.com	
22	Meenal Chaudhary	9529014604	meenachaudhary2004@gmail.com	
23	Anjali M. Singh	8317296731	anjalisingh05152451@gmail.com	
24	Sakshi S. Chaudhary	8766852462	Sakshi	

Signature of:
Programme In-charge

IQAC Coordinator
Dharampeth M. P. Deo Memorial
Science College, Nagpur-440033

Principal
Dharampeth M. P. Deo Memorial
Science College, NAGPUR



DHARAMPETH M. P. DEO MEMORIAL SCIENCE COLLEGE,
North Ambazari Road, Near Ambazari Lake, Nagpur- 440033

DATA VALIDATION & VERIFICATION (DVV)

Sr. No.	Name of the Participant	Mobile Number	E-mail Id	Signature
1	Khushi-K. Rewade	9588445994	khushirewade@gmail.com	
2	Lucky A Vishwakarma	9579660188	LVvishwakarma239@gmail.com	
3	Aujali Meshram	7767905772	aujali.meshram2023@gmail.com	
4	Sonali Chaudhari	8836055033	sonalichaudhari19@gmail.com	
5	Aakansha Maitra	8010923662	aakanyogi@gmail.com	
6	Geausi Bhojare	8668335875	bhoyargausi754@gmail.com	
7	Rashi R. Sapute	9148486983	rashisapute.77@gmail.com	
8	Sakshi Chaudhary	8765852462	Sakshi.chaudhary 753333@gmail.com	

Signature of:
Programme In-charge

IQAC Coordinator
Dharampeth M. P. Deo Memorial
Science College, Nagpur-440033

Principal
Dharampeth M. P. Deo Memorial
Science College, NAGPUR.



DHARAMPETH M. P. DEO MEMORIAL SCIENCE COLLEGE, NAGPUR
INTERNAL QUALITY ASSURANCE CELL (IQAC)

Activity Report

Date: 16/09/2022

Name of Organizing Department or Committee: Chemistry

Name of the activity: Awareness Programme under Environmental Studies

Suggested CRITERION point if any: _Criteria VII

Date of Activity: 16th September 2022

Place of Activity: Late Shri Vinakrao Phatak Hall

Name of Guest Speaker/s or Judge/s or Chief Guest/s if any: Dr.P.R. Sakhare

Title of the Activity: Reintroduction of Cheetah in India

Number of Participants: 145

Name of the Teacher In-charge / Convener: Dr Vaishali Meshram

Names of other Committee Members / Staff: Nil

OUTCOME of the Activity with respect to mission vision of the institute and or academics:

Awareness raising and sensitization of College Students regarding the importance of Cheetah and its reintroduction in India region This Awareness Programme under Environmental studies which helps students to know about the Reintroduction of Cheetah in India.

Activity with newspaper coverage if any: Nil

Activity data save in PC of:

Note: Kindly share geotag photographs separately along with report on iqacdsc2022@gmail.com



Prof. Pitambar Humane
IQAC Coordinator
CO ORDINATOR
INTERNAL QUALITY ASSURANCE CELL
DHARAMPETH, M. P. DEO MEMORIAL &
SCIENCE COLLEGE, NAGPUR

Name & Signature of Teacher In-charge

Dr. Ashilesh Peshwe
Principal
PRINCIPAL

Dharampeth M.P. Deo Memorial
Science College, Nagpur-440033



DHARAMPETH M. P. DEO MEMORIAL SCIENCE COLLEGE,
North Ambazari Road, Near Ambazari Lake, Nagpur- 440033

DATA VALIDATION & VERIFICATION (DVV)

Name of the Programme : Environmental Awareness Programme
Date of the Programme : 16/09/2022
Name of Chief Guest if any : Dr. Purushottam Sakhare
Name of Guest Speaker if any : _____

Sr. No.	Name of the Participant	Mobile Number	E-mail Id	Signature
1.	Ved S. Choudhary	7498572766	vedchoudhary.cs.749@gmail.com	
2.	Mohit M. Khadkekar	8055328357	mohitkhadkekar@gmail.com	
3.	Sandeep Kumar	8081144948	sandeepk27900@gmail.com	
4.	Ankit A. Patel	9970905638	ankitpatel77779@gmail.com	
5.	Bhargavi Sambare	7709403806	bhargavisambare05@gmail.com	
6.	hanmi Gorle	7758058517	hanmigorle19320@gmail.com	
7.	Bishwarya Jashi	7498328662	bishwaryajashi2003@gmail.com	
8.	Nandini Hedge	9370301679	nandinihedge17@gmail.com	
9.	Ishika Thakre	8010907069	ishikathakre22@gmail.com	
10.	Anjali Pali	7498102109	palianjali446@gmail.com	

Signature of:
Programme In-charge

CO ORDINATOR
INTERNAL QUALITY ASSURANCE CELL
DHARAMPETH, M. P. DEO MEMORIAL &
SCIENCE COLLEGE, NAGPUR

PRINCIPAL
Dharampeth M.P. Deo Memorial
Science College, Nagpur-440033



DHARAMPETH M. P. DEO MEMORIAL SCIENCE COLLEGE,
North Ambazari Road, Near Ambazari Lake, Nagpur-440033

DATA VALIDATION & VERIFICATION (DVV)

11	Peanali -Y. Chavhare	9694654562	peanali.chavhare2009@gmail.com	Chavhare
12	Meenal .A. Choudhary	9529019604	meenalchoudhary2004@gmail.com	Choudhary
13	pratiksha Meshram	8459070338	meshrampratiksha14@gmail.com	Meshram
14	Kiran K. ghughekar	9823710569	ghughekar.kiran2004@gmail.com	gh.
15	TANU . AJAY . SINGH	8806855808	tanusingh63492@gmail.com	Tanu
16	Sushma gangadhar guenule	9156238747	Sushma.guenule12@gmail.com	Guenule
17	Vaishali D. Patle	9322600647	vaishalipatle@gmail.com	Patle
18	Shikha J. Yadav	7263881320	Shikha.yadav52002@gmail.com	Shikha
19	Anjali . M. Singh	8317296731	anjalisinghas152451@gmail.com	Anjali
20	Aakansha Y mairal	8010923662	aakanyogi2009@gmail.com	Ay mairal
21	Ankita M. Mishra	8421293176	mishra.ankita4689@gmail.com	Ankita Mishra
22	Muskan . R. Yadav.	9579492617	muskan.yadav1225	Muskan
23	Jagriti A. Rawat	9265818046	Jagriti.jit rawat53@gmail.com	Rawat
24	Nilish . Dipak . Hulke	8624091652	hulkenilish@gmail.com	Hulke
25	Achitya .G. Dalkar	9028915716	dalkar.achitya87@gmail.com	Dalkar
26	Nikhil . R. Raut	9022690159	rautn6541@gmail.com	Raut

Signature of:

Programme In-charge

CO ORDINATOR
INTERNAL QUALITY ASSURANCE CELL
DHARAMPETH, M. P. DEO MEMORIAL &
SCIENCE COLLEGE, NAGPUR

PRINCIPAL
Dharampeth M.P. Deo Memorial
Science College, Nagpur-440033



DHARAMPETH M. P. DEO MEMORIAL SCIENCE COLLEGE,
North Ambazari Road, Near Ambazari Lake, Nagpur-440033

DATA VALIDATION & VERIFICATION (DVV)

27.	Tisha Kature	9021541048	tishakature@gmail.com	Ti
28.	Utkarsha Ingale	7494159178	utkarshaingale9@gmail.com	U. Ingale
29.	Tanvi Kishnapure	7058235293	Tanvikishnapure@gmail.com	Kishnapure
30.	Prachiya Tirpude	8010362232	prachiya.tirpude@gmail.com	Prachiya
31.	Tushal R. Achau	9075995617	achautushal5@gmail.com	Tushal
32.	Gendral B. Machade	9112142728	nikhil.machade@gmail.com	Gendral
33.	Aniket S. Kumbhar	8262817299	avckumbhar@gmail.com	Aniket
34.	Yukti Choudhary	7020953938	yukti.choudhary@gmail.com	Yukti
35.	Khushabu H. Choudhary	7262074960	khushabu@gmail.com	Khushabu
36.	Janani V. Patil	7263819173	Jananipatil10@gmail.com	Janani
37.	Dolly P. Sonkawade	7020826932	dollysonkawade110@gmail.com	Dolly
38.	Devashri D. Bisen	7773980643	DBisen74@gmail.com	Devashri
39.	Ashlesha Sangale	9503998469	ashleshasangale99	Ashlesha
40.	Devashish Bisen	7767861281	DevashishBisen31	Devashish
41.	Abhishek Deshbhutar	8208302902	AbhishekDeshbhu	Abhishek
42.	Subbu R. Mishra	9860436418	Subbumishra234@gmail.com	Subbu

Signature of:

Programme In-charge

CO-ORDINATOR
INTERNAL QUALITY ASSURANCE CELL
DHARAMPETH, M. P. DEO MEMORIAL &
SCIENCE COLLEGE, NAGPUR

PRINCIPAL
Dharampeth M.P. Deo Memorial
Science College, Nagpur-440033



DHARAMPETH M. P. DEO MEMORIAL SCIENCE COLLEGE,
North Ambazari Road, Near Ambazari Lake, Nagpur-440033

DATA VALIDATION & VERIFICATION (DVV)

1.	Devangi Agashe	9175936783	devangiagaste05@gmail.com	IP Agashe
2.	Megha S. Ballav	9421728880	meghaballav04@gmail.com	M Ballav
43.	Aditi S. Jogi	9579962108	aditi.jogi2002@gmail.com	Aditi
44.	Samiksha A. Panchbudhe	9763075890	samikshapanchbudhe@gmail.com	S. Panchbudhe
45.	Janvi V. Khode	7355066639	janvikhode842@gmail.com	Janvi
46.	Prachi G. Pardhi	7263935912	prachipardhi282@gmail.com	P.G. Pardhi
47.	Kalyani P. Jadhav	8626038611	kalyanijadhav31@gmail.com	K. Jadhav
48.	Branali Gupta	7020069377	branaligupta808@gmail.com	B. Gupta
49.	Ritika Bhojar	9834581087	ritikabhoyar28@gmail.com	R. Bhojar
50.	Jagriti Fulkar	8767911307	Jagritifulkar@gmail.com	J. Fulkar
51.	Divyanshi Zagade	9022866318	divyanshizagade@gmail.com	Divyanshi
52.	Sonia Niswal	7058425021	sonia70@gmail.com	S. Niswal
53.	Devashti Patil	8308890446	Devashtipatil63@gmail.com	D. Patil
54.	Vidya Lohi	7020963279	Vidyalohi8@gmail.com	V. Lohi
55.	Vaishali R. Tiwari	8408019938	vaishalitiwari@gmail.com	V. Tiwari
56.	Vaishali S. Patil	9322600647	vaishalipatil@gmail.com	V. Patil
57.	Shikha Yadav	7203881320	Shikhayadav5@gmail.com	S. Yadav

Signature of:

Programme In-charge

CO ORDINATOR

INTERNAL QUALITY ASSURANCE CELL
DHARAMPETH, M. P. DEO MEMORIAL &
SCIENCE COLLEGE, NAGPUR

PRINCIPAL

Dharampeth M.P. Deo Memorial
Science College, Nagpur-440033



DHARAMPETH M. P. DEO MEMORIAL SCIENCE COLLEGE,
North Ambazari Road, Near Ambazari Lake, Nagpur- 440033

DATA VALIDATION & VERIFICATION (DVV)

Name of the Programme : Environmental awareness Programme
Date of the Programme : 16/09/2022
Name of Chief Guest if any : Dr. Purushottam Sakhare.
Name of Guest Speaker if any : _____

Sr. No.	Name of the Participant	Mobile Number	E-mail Id	Signature
58	Ved. S. Choudhary	7498572768	vedchoudhary.cs.749@gmail.com	
59	Mohit Khadkekar	2053328357	mohitkhadkekar@gmail.com	
60	Ankit Patel	9970905638	ankitpatel797275@gmail.com	
61	Sandeep Kumar	8081144940	sandeepk27900@gmail.com	
62	Lanesh Rathod	9309962384	laneshrathod1234@gmail.com	
63	Shubham Kumbhakar	8237923966	Kumbhakarshubhamer09	
64	Vishwajeet Tayde	9767984306	Taydevishwajeet0	
65	Lucky A. Vishwakarma	9579660186	Lucky_239@a	
66	Nihal V. Makhram	8767792960	nihalv.makhram@gmail.com	
67	Tejas R. Chelmalwar	9604662119	tejaschelmalwar@gmail.com	

Signature of:

Programme In-charge

IQAC Coordinator
COORDINATOR
INTERNAL QUALITY ASSURANCE CELL
DHARAMPETH, M. P. DEO MEMORIAL &
SCIENCE COLLEGE, NAGPUR

Principal
PRINCIPAL
Dharampeth M.P. Deo Memorial
Science College, Nagpur-440033



DHARAMPETH M. P. DEO MEMORIAL SCIENCE COLLEGE,
North Ambazari Road, Near Ambazari Lake, Nagpur- 440033

DATA VALIDATION & VERIFICATION (DVV)

Name of the Programme : Environmental awareness Programme
Date of the Programme : 16/09/2022
Name of Chief Guest if any : Dr. Purushottam Sakhan
Name of Guest Speaker if any : _____

Sr. No.	Name of the Participant	Mobile Number	E-mail Id	Signature
68	Pritam S. Kature	8010793204	pritamkature655@gmail.com	
69	Khushi Pali	8767607224	PaliKhushi61@gmail.com	
70	Kashish Bisen	7887886117	kashishbisen25@gmail.com	
71	Harshata Warkhede	8263977203	harshatawarkhede@gmail.com	
72	Yogita J. Karamore	8381045307	yogita.karamore25@gmail.com	
73	Nisha S. Karamore	9890996645	nisha.karamore33@gmail.com	
74	Deepak Kulkarni	7061735473	deepakdekkk2005@gmail.com	
75	Shivam Patel	7038889083	Sp040263@gmail.com	
76	Dinesh Patil	7038889083		
77	Aniket Bawankar	8767219307	Aniketbawankar@gmail.com	

Signature of:

Programme In-charge

CO-ORDINATOR
INTERNAL QUALITY ASSURANCE CELL
DHARAMPETH, M. P. DEO MEMORIAL &
SCIENCE COLLEGE, NAGPUR

PRINCIPAL
Dharampeth M. P. Deo Memorial
Science College, Nagpur-440033



DHARAMPETH M. P. DEO MEMORIAL SCIENCE COLLEGE,
North Ambazari Road, Near Ambazari Lake, Nagpur- 440033

DATA VALIDATION & VERIFICATION (DVV)

38	Satish. Thru	9022526407	Satish1413@gmail.com	Satish
39	Tejraj G. Salunke	7030730670	Tejraj.salunke208@	
40	Ganesh madge	7972076671	ganeshmadge@gmail.com	Ganesh
41	Bhijwal bhayast	8010434634	Bhijwalb738@gmail.com	
42	harsh kodape	9604677672	harshkodape00@gmail.com	@kodape
43	Vedant B. ray	8520455796	vedantray2102@gmail.com	vedant
44	Abhay Tembhare	8175363145	abhay230102@gmail.com	Abhay
45	Nitu B. Rai	7058688984	nitul419@gmail.com	Nitu
46	Ashashree U. Dhokane	7774900320	ashashreeu@gmail.com	Ashashree
47	Aarushi Hussain	7066411418	hussainarushi1994@gmail.com	Aarushi
48	Pratya Sharma	8010764543	pratyasharma1994@gmail.com	Pratya
49	Sejal Kolhe	8983415985	sejalkolhe01@gmail.com	Sejal
50	Chanchal. K. Waghwani	7796016894	waghwanitara@gmail.com	Chanchal
51	Lucky A. Vishwakarma	9579660186	lvishwakarma1990@gmail.com	Lvishwakarma
52	Aakanksha. K. Khobragade	7972828707	aakankshakhobragade@gmail.com	Aakanksha

Signature of:

Programme In-charge

CO ORDINATOR
INTERNAL QA/COORDINATOR
DHARAMPETH, M. P. DEO MEMORIAL &
SCIENCE COLLEGE, NAGPUR

Principal
Dharampeth M. P. Deo Memorial
Science College, Nagpur-440033.

Tisd / Sat



DHARAMPETH M. P. DEO MEMORIAL SCIENCE COLLEGE,
North Ambazari Road, Near Ambazari Lake, Nagpur- 440033

DATA VALIDATION & VERIFICATION (DVV)

83)	Kaustubh R. Rantere	7218987714	T-12	kaanterekaustubh2002@gmail.com
84)	Nitin Manik Khede	9561179324	T-7	manikkhede.kvijay@gmail.com
85)	Amit J. Walde	9168496253	T-7	amitwalde44odivya@gmail.com
86)	Gurjan Bhayare	7666799586	F-11	Aac GurjanBhayare@gmail.com
87)	Amisha Ankara	76668559171	F-11	AmishaAnkara@gmail.com
88)	Rashi P. Satpute	9145486983	F-12	rashisatpute27@gmail.com
89)	Nihal V. Meshram	8707742900	F-7	Nihalmeshram74@gmail.com
90)	Suraj Mishra	9730639023	F-7	Surajmishra955104@gmail.com
91)	Mounali D. Bhilkar	9322474616	F-8	mounaliBhilkar@gmail.com
92)	Neha L. Wanjari	9373832266	F-15	nehawanjari732@gmail.com
93)	Poojali L. Meshram	9888090054	F-12	poojalimeshram81@gmail.com
94)	Sumit Bhandarkar	275212339	S-15	sumitbhandarkar100@gmail.com
95)	Pooja Itankar	9156978252	S-14	poojaitankar987@gmail.com
96)	Mansi Fatig	8767154686	S-8	mansifatig2110@gmail.com
97)	Jyoti Sharma	8669736880	S-15	jyotis390@gmail.com
98)	Siddhant Hinikare	9579092931	S-14	siddhantHinikare@gmail.com
99)	Khushi N. Susiyawanshi	7972437504	S-8	Khushisusiyawanshi1189@gmail.com
Signature of:	Rupam M. Sharma	8322042269	S-8	Rupamsharma268@gmail.com

Signature of:

[Signature]
Programme In-charge

CIQAC Coordinator
INTERNAL QUALITY ASSURANCE CELL
DHARAMPETH, M. P. DEO MEMORIAL &
SCIENCE COLLEGE, NAGPUR

Principal
[Signature]
PRINCIPAL
Dharampeth M.P. Deo Memorial
Science College, Nagpur-440033

Fr./Sat



DHARAMPETH M. P. DEO MEMORIAL SCIENCE COLLEGE,
North Ambazari Road, Near Ambazari Lake, Nagpur- 440033

DATA VALIDATION & VERIFICATION (DVV)

Name

Ph

Batch

Email

98)	Rukhi. Prabhakar Gedum	7378312504	T11	gedumrukhi2000@gmail.com
99)	Supriya Patle	7757871925	T7	PatleSupriya021@gmail.com
100)	Jayashree D. Hiwase	7385473157	T11	Juhihiwase10@gmail.com
101)	Briyanka L. Gujwar	9579263881	T12	Briyankagujwar2000@gmail.com
102)	Jagruti D. Wankar	7447366023	S15	jayrutiwankar@gmail.com
103)	Juhi Chaudhari	8669248944	S15	chaudharijuhi20@gmail.com
104)	Sakshi Meshram	9145355733	S15	sakshimeshram2@gmail.com
105)	Mansi Mate	8468891807	S15	mansi19182@gmail.com
106)	Kalpna Sunagpure	9579236712	S14	kalpansunagpure@gmail.com
107)	Rohit Parate	9373097285	S14	ParateRohit@gmail.com
108)	Surbhi Parde	7887516628	S14	surbhi671@gmail.com
109)	Chhakuli Wadikar	9325047907	S14	chhakuliwadikar@gmail.com
110)	Vaishnavi Lakhe	8669594854	S14	vaishnavilakhe@gmail.com
111)	Tina Rahangdale	9921776767	S14	dinorahangdale@gmail.com
112)	Niket Thakare	7378299081	S14	niketthakare92@gmail.com

Signature of:

Programme In-charge

IQAAC Coordinator
INTERNAL QUALITY ASSURANCE CELL
DHARAMPETH, M. P. DEO MEMORIAL &
SCIENCE COLLEGE, NAGPUR

Principal
PRINCIPAL

Dharampeth M.P. Deo Memorial
Science College, Nagpur-440033



DHARAMPETH M. P. DEO MEMORIAL SCIENCE COLLEGE,
North Ambazari Road, Near Ambazari Lake, Nagpur- 440033

DATA VALIDATION & VERIFICATION (DVV)

114.52	Tejas. Rewade	7796027056	S-14	tejasrewade86@gmail.com
115.51	Jasraj Paliwal	9370820325	S-8 Jap.	jasrajpaliwal77@gmail.com
116.53	Varshnavi J. Bedade	8657188093	varshnavibedade10@gmail.com	Varshnavi
117.53	Sumit Banolebuche	8788212339	S-15	Sumitbanolebuche10@gmail.com
118.54	Pooja Itankar	9156973252	S-14	poojaitankar2888@gmail.com
119.54	Mansi Fating	8767134686	S-8	mansifatinge110@gmail.com
120.51	Jyoti Shasrma	8669736380	S-15	jyoti1390@gmail.com
121.51	Siddhant Hirskane	9579092931	S-14	SiddhantHirskane@gmail.com
122.54	Khushi.N. Suryawanshi	7972437504	S-8	KhushiSuryawanshi1180@gmail.com
123.53	Nupur. Shasrma	9322042259	S-8	nupurshasrma268@gmail.com
124.53	AMAN.A. DONGRE	7709217312	S-15	amandongre2023@gmail.com
125.51	Sania Raza	8975726700	S-15	niddhakauia@gmail.com
126.51	Divya Hanote	8605422901	S-8	divyahanote@gmail.com
127.51	Kavita Mishra	9657199261	S-8.	10783280@gmail.com

Signature of:

Programme In-charge

CO ORDINATOR
INTERNAL QUALITY ASSURANCE CELL
IQAC Coordinator
DHARAMPETH, M. P. DEO MEMORIAL &
SCIENCE COLLEGE, NAGPUR

Principal
DHARAMPETH M.P. DEO MEMORIAL
SCIENCE COLLEGE, NAGPUR-440033



DHARAMPETH M. P. DEO MEMORIAL SCIENCE COLLEGE,
North Ambazari Road, Near Ambazari Lake, Nagpur- 440033

DATA VALIDATION & VERIFICATION (DVV)

128	Umila Bandar.	9370673867	bandeumila.2010@gmail.com	<u>Bandar</u>
129	Shreya Dhasale.	8888264004	shreyadhasale.24@gmail.com	<u>Dhasale</u>
130	Vaibhavi Shinde	8080640782	Vaibhavishinde97@gmail.com	<u>Shinde</u>

Signature of:

[Signature]
Programme in charge

[Signature]

COORDINATOR
INTERNAL QUALITY ASSURANCE CELL
DHARAMPETH, M. P. DEO MEMORIAL &
SCIENCE COLLEGE, NAGPUR

[Signature]
PRINCIPAL

Dharampeth M.P. Deo Memorial
Science College, Nagpur-440033



DHARAMPETH M. P. DEO MEMORIAL SCIENCE COLLEGE,
North Ambazari Road, Near Ambazari Lake, Nagpur- 440033

DATA VALIDATION & VERIFICATION (DVV)

Name of the Programme : Environmental awareness programme
Date of the Programme : 16/09/2022
Name of Chief Guest if any : Dr. Puvushottam Sakhare
Name of Guest Speaker if any : _____

Sr. No.	Name of the Participant	Mobile Number	E-mail Id	Signature
131.	Nitu B. Rai	7058638984	onit1419@gmail.com	
132.	Abhay P. Tembhore	8975363145	abhay230102@gmail.com	
133.	Lucky A Vishwakarma	9579660186	lvishwakarma240@gmail.com	
134.	Anjali R. Pals	7498102109	pali.anjali44@gmail.com	
135.	Laxmi Gome	9758038514	laxmi20@gmail.com	
136.	Jshika Thakre	8010907069	ichithakre2001@gmail.com	
137.	Samiksha Chaudhari	7517090406	chaudharysamiksha26@gmail.com	
138.	shreyansh S. Nalkwar	7447844189	shreyanshnalkwar@gmail.com	
139.	Aadesh K. Harkar	7577431162	aadeshkhar@gmail.com	
140.	Jshwan U. Suryawanshi	8087917097	suryawanshishwan@gmail.com	

Signature of:

Programme In-charge

IQAC Coordinator

CO ORDINATOR
INTERNAL QUALITY ASSURANCE CELL
DHARAMPETH, M. P. DEO MEMORIAL &
SCIENCE COLLEGE, NAGPUR

Principal

PRINCIPAL
Dharampeth M.P. Deo Memorial
Science College, Nagpur-440033



DHARAMPETH M. P. DEO MEMORIAL SCIENCE COLLEGE,
North Ambazari Road, Near Ambazari Lake, Nagpur- 440033

DATA VALIDATION & VERIFICATION (DVV)

141	Raksha D. Dhote	7498511875	arakshadhote3@gmail.com	Raksha Dhote
142	Priyanshi P. Singh	7219259020	priyanshi.singh1804@gmail.com	Singh
143	Shivam Maurya	9607873702	Shivammaurya@gmail.com	Ma
144	Pragya Jha	9665852915	Pragya1697@gmail.com	PJ
145	Ashuman Sharma	937082462	ashumansharma@gmail.com	A

Signature of:

Programme In-charge

COORDINATOR
INTERNAL QUALITY ASSURANCE CELL
DHARAMPETH, M. P. DEO MEMORIAL &
SCIENCE COLLEGE, NAGPUR

Principal
PRINCIPAL

Dharampeth M.P. Deo Memorial
Science College, Nagpur-440033



**DHARAMPETH M.P. DEO MEMORIAL SCIENCE COLLEGE, NAGPUR
ROTARACT CLUB OF DMPDSVM**

Activity Report

Date: 30/09/2022

Name of Organizing Department or Committee: Rotaract Club

Name of the activity: Note Making and Note Taking

Suggested CRITERION point if any: Criterion III & Criterion V

Date of Activity: 17/09/2022

Place of Activity: Mundle Public School, Wardha Road, Nagpur

Name of Guest Speaker /s or Judge/s or Chief Guest/s if any: Dr. Mrs. Shraddha Deshpande

Title of the Activity: Note Making and Note Taking

Number of Participants: 04

Name of the Teacher In-charge/ Convener: Dr. Mrs. Shraddha Deshpande

Names of other Committee Members / Staff: Rotaract Club Members

OUTCOME of the Activity with respect to mission vision of the institute and or academics:

The activity helped the students to know the benefits of note taking and note making such as improvement in focus, increase in memory, clarity of the subject etc. The Rotaract members helped the school students to make such notes by giving them ideas on note making.

Activity with newspaper coverage if any: Nil

Activity data save in PC of: Department of English



Prof. Pitambar Humane

IQAC Coordinator

CO ORDINATOR

INTERNAL QUALITY ASSURANCE CELL
DHARAMPETH, M. P. DEO MEMORIAL &
SCIENCE COLLEGE, NAGPUR

Dr. Mrs. Shraddha Deshpande

Teacher In-charge

Dr. Akhilesh Peshwe

Principal

Dharampeth M.P. Deo Memorial
Science College, Nagpur.



DHARAMPETH M.P.DEO MEMORIAL SCIENCE COLLEGE, NAGPUR

ROTARACT CLUB 22-23

Note Making and Note Taking

17 September 2022

Rotary.org Link





DHARAMPETH M.P.DEO MEMORIAL SCIENCE COLLEGE, NAGPUR

ROTARACT CLUB 22-23

Note Making and Note Taking

17 September 2022

List of Students

1. Rtr. AnanyaMotghare: 7219218955
2. Rtr.Nupur Sharma:9322042259
3. Rtr.SimranDhimole: 7666330683
4. Rtr.IshitaDeshpande: 9130091540

Prof. Pitambar Humane
IQAC Coordinator
CO ORDINATOR
INTERNAL QUALITY ASSURANCE CELL
DHARAMPETH, M. P. DEO MEMORIAL &
SCIENCE COLLEGE, NAGPUR

Dr. Mrs. Shraddha Deshpande
Teacher In-charge

Dr. Akhilesh Peshwe
Principal
Dharampeth M.P. Deo Memorial
Science College, Nagpur.



DHARAMPETH M. P. DEO MEMORIAL SCIENCE COLLEGE, NAGPUR

INTERNAL QUALITY ASSURANCE CELL (IQAC)

Activity Report

Date: 17th September 2022

Name of Organizing Department or Committee: Electronics Department
Name of the Activity : Studying the specifications of Laser diode and Photodiode using datasheet(NEP)
Suggested CRITERION point if any: Suggested criteria II
Date of Activity: 17th September 2022
Place of Activity : Electronics Lab

Name of Guest Speaker/s or Judge/s or Chief Guest/s if any : Not applicable
Title of the Activity: Studying the specifications of Laser diode and Photodiode using datasheet
Based on Unit : 1(Paper I)
Class : Semester V
Number of Participants : 19

Name of the Teacher In-charge / Convener: Mrs. Leena P. Thakare

OUTCOME of the Activity with respect to mission vision of the institute and or academics:

Laser diode and Photodiode are very important components in optical fibre communication. Students learn about the technical terms related to Laser diode and Photodiode. They also studied the characteristics graph of Laser diode and Photodiode.

Prof. Varsha V. Rangari

Head of the Department

Prof. Pitambar Humane

IQAC Coordinator

CO ORDINATOR

**INTERNAL QUALITY ASSURANCE CELL
DHARAMPETH, M. P. DEO MEMORIAL &
SCIENCE COLLEGE, NAGPUR**

Dr. Akhilesh Peshwe

Principal

**Dharampeth M.P. Deo Memorial
Science College, Nagpur.**



Dharampeth M. P. Deo Memorial Science College,
Nagpur

Electronics Department
Semester V - (2022-23)

Activity 1
Based on Paper I -Unit 1

Date: 17/09/2022

Activity: Studying the specifications of Laser diode and Photodiode using datasheet

Objective:

- To make the students aware about the technical specification and characteristics of Laser diode and photodiode.

Sr. No.	Students Name	Signature
1.	Saurabh P. Sharma	
2.	Prathmesh Badhise	
3.	Pratiksha Umare	
4.	Sakshi Huddar	
5.	Sakshi Hiwarkar	
6.	Soniya Chaniya	
7.	Bhavesh Maske	
8.	Aarti Singh	
9.	Megha T Bisen	
10.	Ankita L. Sonwane	
11.	Kiran Waghade	
12.	Tanmay S. Gadam	
13.	Rani Kokate	
14.	Nikhil Jankar	
15.	Pratham - Sonar	
16.	Pranav Mahajan	



DHARAMPETH M. P. DEO MEMORIAL SCIENCE COLLEGE, NAGPUR
Department of Electronics
Semester V - (2022-23)
ACTIVITY (Paper I - Unit- 1)

Sr. No.	Student Name	Mobile Number	Email ID
1	Saurabh Pratap Sharma	9130964601	saurabhs44002@gmail.com
2	Prathmesh Sanju Badhiye	9765262138	nikita24badhiye@gmail.com
3	Pratiksha Shamrao Umare	8806402970	pratiksha2019uu@gmail.com
4	Sakshi Sanjay Huddar	9405142450	huddarmahi@gmail.com
5	Sakshi Satish Hiwarkar	9356651344	Sakshihiwarkar1831@gmail.com
6	Soniya Bhishamber Chaniya	7028563411	rvchaniya@gmail.com
7	Bhaves Rameshwar Maske	7489951631	bhavesmaske2002@gmail.com
8	Aarti Brijkishor Singh	7709208740	aartibsingh222@gmail.com
9	Megha Tribhuwan Bisen	9637770341	bisenmegha320@gmail.com
10	Ankita Laxman Sonwane	9284801790	ankitasonwane10@gmail.com
11	Kiran Ramesh Waghade	9860218676	rameshwaghade20@gmail.com
12	Tanmay Sunil Gadam	7262034396	tanmaygadam1@gmail.com
13	Rani Devidas Kokate	7998945148	ranikokate1009@gmail.com
14	Nikhil Kiran Ijankar	8530960407	nikhilijankar@gmail.com
15	Pratham Manbahadur Sonar	7558464862	manbhaisonar@gmail.com
16	Pranay Santosh Mahajan	9158377419	pranaymahajan413@gmail.com
17	Mahesh Prabhakar Rao Maske	9021951173	maheshmaske48@gmail.com
18	Rajat Laxman Rohad	9175635273	
19	Mukund Sanjay Hood	9604785822	mukundahood2003@gmail.com

Name & Signature of Teacher In-Charge

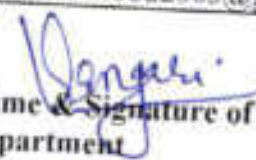
Name & Signature of Head of the Department

Prof. Pitambar Humane
IQAC Coordinator
CO ORDINATOR
INTERNAL QUALITY ASSURANCE CELL
DHARAMPETH, M. P. DEO MEMORIAL &
SCIENCE COLLEGE, NAGPUR

Dr. Akhilesh Peshwe
Principal
Principal
Dharampeth M.P. Deo Memorial
Science College, Nagpur.



DHARAMPETH M. P. DEO MEMORIAL SCIENCE COLLEGE, NAGPUR

Department of Electronics

Semester V- (2022-23)

ACTIVITY (Paper II - Unit- 1)

Sr. No.	Student Name	Mobile Number	Email ID
1	Nikhil Kiran Ijankar	8530960407	nikhilijankar@gmail.com
2	Pratham Manbahadur Sonar	7558464862	manbhaisonar@gmail.com
3	Mukund Sanjay Hood	9604785822	mukundahood2003@gmail.com
4	Rajat Laxman Rohad	9175635273	
5	Bhavesh Rameshwar Maske	7489951631	bhaveshmaske2002@gmail.com
6	Mahesh Prabhakarrrao Maske	9021951173	maheshmaske48@gmail.com
7	Sagar Omprakash Sonwane	9356591564	sagarsonwane706@gmail.com
8	Samiksha Vasant Tabhane	9307133863	samikshavtabhane@gmail.com
9	Ankita Laxman Sonwane	9284801790	ankitasonwane10@gmail.com
10	Aarti Brijkishor Singh	7709208740	aartibsingh222@gmail.com
11	Kiran Ramesh Waghade	9860218676	rameshwaghade20@gmail.com
12	Sakshi Sanjay Huddar	9405142450	huddarmahi@gmail.com
13	Sakshi Satish Hiwarkar	9356651344	Sakshihiwarkar1831@gmail.com
14	Soniya Bhishamber Chaniya	7028563411	rvchaniya@gmail.com
15	Tanmay Sunil Gadam	7262034396	tanmaygadaml@gmail.com
16	Pranay Santosh Mahajan	9158377419	pranaymahajan413@gmail.com
17	Prakash Madhuvilas Khanal	7796875388	Khanalprakash151@gmail.com
18	Saurabh Pratap Sharma	9130964601	saurabhs44002@gmail.com
19	Rani Devidas Kokate	7998945148	ranikokate1009@gmail.com
20	Abhijeet Shrikant Mankar	8309664405	abhijeetmankar5@gmail.com

Name & Signature of Teacher In-Charge



Prof. Pitambar Humane
IQAC Coordinator

CO ORDINATOR

INTERNAL QUALITY ASSURANCE CELL
DHARAMPETH, M. P. DEO MEMORIAL &
SCIENCE COLLEGE, NAGPUR

Name & Signature of Head of the Department



Dr. Varsha V. Rangari
Professor & Head
Department of Electronics
Dharampeth M.P. Deo Memorial
Science College, Nagpur



Dr. Akhilesh Peshwe
Principal

Principal
Dharampeth M.P. Deo Memorial
Science College, Nagpur.



DHARAMPETH M. P. DEO MEMORIAL SCIENCE COLLEGE, NAGPUR
Department of Electronics
Semester V - (2022-23)
ACTIVITY (Paper I - Unit- 1)

Sr. No.	Student Name	Mobile Number	Email ID
1	Saurabh Pratap Sharma	9130964601	saurabhs44002@gmail.com
2	Prathmesh Sanju Badhiye	9765262138	nikita24badhiye@gmail.com
3	Pratiksha Shamrao Umare	8806402970	pratiksha2019uu@gmail.com
4	Sakshi Sanjay Huddar	9405142450	huddarmahi@gmail.com
5	Sakshi Satish Hiwarkar	9356651344	Sakshihiwarkar1831@gmail.com
6	Soniya Bhishamber Chaniya	7028563411	rvchaniya@gmail.com
7	Bhavesh Rameshwar Maske	7489951631	bhaveshmaske2002@gmail.com
8	Aarti Brijkishor Singh	7709208740	aartibsingh222@gmail.com
9	Megha Tribhuwan Bisen	9637770341	bisenmegha320@gmail.com
10	Ankita Laxman Sonwane	9284801790	ankitasonwane10@gmail.com
11	Kiran Ramesh Waghade	9860218676	rameshwaghade20@gmail.com
12	Tanmay Sunil Gadam	7262034396	tanmayeadam1@gmail.com
13	Rani Devidas Kokate	7998945148	ranikokate1009@gmail.com
14	Nikhil Kiran Jankar	8530960407	nikhiljankar@gmail.com
15	Pratham Manbahadur Sonar	7558464862	manbhaisonar@gmail.com
16	Pranay Santosh Mahajan	9158377419	pranaymahajan413@gmail.com
17	Mahesh Prabhakar Rao Maske	9021951173	maheshmaske48@gmail.com
18	Rajat Laxman Rohad	9175635273	
19	Mukund Sanjay Hood	9604785822	mukundahood2003@gmail.com

Name & Signature of Teacher In-Charge

Prof. Pitambar Humane
IQAC Coordinator

CO ORDINATOR
INTERNAL QUALITY ASSURANCE CELL
DHARAMPETH, M. P. DEO MEMORIAL &
SCIENCE COLLEGE, NAGPUR

Name & Signature of Head of the Department

Dr. Varsha V. Rangari

Professor & Head
Department of Electronics
Dharampeth M.P. Deo Memorial
Science College, Nagpur

Dr. Akhilesh Peshwe
Principal
Principal
Dharampeth M.P. Deo Memorial
Science College, Nagpur.



DHARAMPETH M. P. DEO MEMORIAL SCIENCE COLLEGE, NAGPUR

INTERNAL QUALITY ASSURANCE CELL (IQAC)

Activity Report

Date: 17th September 2022

Name of Organizing Department or Committee: Electronics Department
Name of the Activity : To find the value of Resistor using colour code(NEP)
Suggested CRITERION point if any: Suggested criteria II
Date of Activity: 17th September 2022
Place of Activity : Electronics Lab

Name of Guest Speaker/s or Judge/s or Chief Guest/s if any : Not applicable

Title of the Activity: To find the value of Resistor using colour code
Based on Unit : 1(Paper I)
Class : Semester I
Number of Participants: 14

Name of the Teacher In-charge / Convener: Mrs. Leena P. Thakare

OUTCOME of the Activity with respect to mission vision of the institute and or academics:

Students learn how to use the color code chart to find the value of Resistor. Resistor of different values was given to the students and they were asked to find the values by using color code and by using the mutimeter.

Prof. Varsha V. Rangari

Head of the Department

Prof. Pitambar Humane

IQAC Coordinator
CO ORDINATOR

INTERNAL QUALITY ASSURANCE CELL
DHARAMPETH, M. P. DEO MEMORIAL &
SCIENCE COLLEGE, NAGPUR



Dr. Akhilesh Peshwe

Principal
Principal
Dharampeth M.P. Deo Memorial
Science College, Nagpur.



DHARAMPETH M. P. DEO MEMORIAL SCIENCE COLLEGE, NAGPUR
Department of Electronics
Semester I- (2022-23)
Activity (Paper I - Unit- 1)

Sr. No.	Student Name	Mobile Number	Email ID
1	Tanu Ajay Singh	8806355808	tanusingh63492@gmail.com
2	Simran Narendra Dhimole	8390347026	mishralaxmi210@gmail.com
3	Tushal Rupkumar Achare	9075995617	acharetushal5@gmail.com
4	Vedant Onkar Umretkar	9049932753	umretkarvedant@gmail.com
5	Ved Sudhir Choudhary	7498572766	vedchoudhary.cs.749@gmail.com
6	Bhagyashali Dadarao Neware	7796434177	sakshineware2017@gmail.com
7	Khushi Rajiv Pali	8767607224	palikhushi4@gmail.com
8	Kashish Kamalkumar Bisen	7887886117	kashishbisen05@gmail.com
9	Khushbu Rajiv Pali	8459565214	palikhushbu59@gmail.com
10	Aayushi Vikram Singh	9595119942	senxerox04@gmail.com
11	Vaidhavi Baburao Gongal	7507907278	gayatrigongal787@gmail.com
12	Tejas Ramesh Dongre	9322578918	tejasdongre453@gmail.com
13	Priyanshu Pradeep Singh	9527710380	priyanshusinghji12@gmail.com
14	Vineet Mukesh Singh	9766035354	vineetsingh3533@gmail.com



Name & Signature of Teacher In-Charge

Prof. Pitambar Humane
IQAC Coordinator

CO ORDINATOR
INTERNAL QUALITY ASSURANCE CELL
DHARAMPETH, M. P. DEO MEMORIAL &
SCIENCE COLLEGE, NAGPUR.

Name & Signature of Head of the
Department

Dr. Varsha V. Rongari
Professor & Head
Department of El
Dharampeth M.P. Deo
Science College, Nagpur.

Dr. Akhilesh Peshwe
Principal
Principal
Dharampeth M.P. Deo Memorial
Science College, Nagpur.



DHARAMPETH M. P. DEO MEMORIAL SCIENCE COLLEGE, NAGPUR
INTERNAL QUALITY ASSURANCE CELL (IQAC)

Activity Report (NEP)

Date: 30/09/2022

Name of Organizing Department or Committee: Home science Department

Name of the activity: Making of Posters (Swastha Mata)

Suggested CRITERION point if any:

Date of Activity: 19/09/2022

Place of Activity: Home Science Department

Name of Guest Speaker/s or Judge/s or Chief Guest/s if any:

Title of the Activity: Making of Posters

Number of Participants: 14

Name of the Teacher In-charge / Convener: Mrs Pradnya Bagalkote

Names of other Committee Members / Staff: HOD Manju Deshpande ma'am

OUTCOME of the Activity with respect to the mission vision of the institute and or academics:

Students should learn concept of health and its impact on nation.

Activity with newspaper coverage if any: NA

Activity data save in PC of: Home Science Department



Prof. Pitambar Humane
IQAC Coordinator
CO ORDINATOR
INTERNAL QUALITY ASSURANCE CELL
DHARAMPETH, M. P. DEO MEMORIAL &
SCIENCE COLLEGE NAGPUR

Name & Signature of Teacher In-charge

Dr. Akhilesh Peshwe
PRINCIPAL
DHARAMPETH M. P. DEO
MEMORIAL SCIENCE COLLEGE
NAGPUR

Making Roster



DHARAMPETH M. P. DEO MEMORIAL SCIENCE COLLEGE,
North Ambazari Road, Near Ambazari Lake, Nagpur- 440033

Date:- 19/09/2022

DATA VALIDATION & VERIFICATION (DVV)

Roster

	Name	Number	email ID	Sign
1)	Shalnam. T. madali	9022302785	Shalnammadali5@gmail.com	Shalnam
2)	Riya. V. maity	7350980367	maityriya19023@gmail.com	Riiaidty
3)	Deepika yadav	9709746445	elys199@gmail.com	Dee
4)	Sujata V. Kaurse	9175451202	SujataKaurse1@gmail.com	Sujata
5)	Poonali Ghangudkar	9309079427	Pcin402gh@gmail.com	Poonali
6)	Bhagyashree S. Ambule	9359139068	ambuleb667@gmail.com	Ambule
7)	Pallavi B. Katre	8459277408	PKatre573@gmail.com	Pallavi
8)	Priya K. Khawshi	9763617224	Priyakhawshi3@gmail.com	Priya
9)	Ojasvi M. Wankhede	8767699751	wankhedeojasvi@gmail.com	Ojasvi
10)	Arani Shenwal	9096507459	AraniShenwal15@gmail.com	Ashenwal
11)	Kimaya Kale	8866073792	kimoyakale003@gmail.com	Kimoya
12)	Tanuja Konde	7841984450	kondetanuja3@gmail.com	Tanuja
13)	Vaishnavi K. Pradban	9763169560	Pradbanvaishnavi15@gmail.com	Vaishnavi
14)	Shrushti S. Patkar	7387067403	Shrushtipatkar@gmail.com	Shrushti

Signature of:

Programme In-charge

CO-ORDINATOR
INTERNAL QUALITY ASSURANCE CELL,
DHARAMPETH, M. P. DEO MEMORIAL &
SCIENCE COLLEGE, NAGPUR

Principal
Principal
Dharampeth M.P. Deo Memorial
Science College



DHARAMPETH M. P. DEO MEMORIAL SCIENCE COLLEGE, NAGPUR
INTERNAL QUALITY ASSURANCE CELL (IQAC)
Activity Report NEP

Date: 30/09/2022

Name of Organizing Department or Committee: Home Science Department.

Name of the activity: Essay writing on Malnutrition.

Suggested CRITERION point if any:

Date of Activity: 19/09/2022

Place of Activity: Home Science department

Name of Guest Speaker/s or Judge/s or Chief Guest/s if any:

Title of the Activity: Essay writing on Malnutrition

Number of Participants: 18

Name of the Teacher In-charge / Convener: Mrs Pradnya Bagalkote.

Names of other Committee Members / Staff: HOD Manju Deshpande Mam

OUTCOME of the Activity with respect to the mission vision of the institute and or academics: To understand concept of Malnutrition and its impact on health.

Activity with newspaper coverage if any:

Activity data save in PC of:

Note: Kindly share geotag photographs separately along with report on igacdsc2022@gmail.com

Prof. Pitambar Humane

IQAC Coordinator

CO-ORDINATOR

INTERNAL QUALITY ASSURANCE CELL

DHARAMPETH M. P. DEO MEMORIAL &

SCIENCE COLLEGE, NAGPUR

^{PK}
Name & Signature of Teacher In-charge

Dr. Akhilesh Peshwe

Principal

Principal

**Dharampeth M.P. Deo Memorial
Science College, Nagpur.**

Essay writing on Malnutrition

Date:- 19/9/2022



DHARAMPETH M. P. DEO MEMORIAL SCIENCE COLLEGE,
North Ambazari Road, Near Ambazari Lake, Nagpur- 440033

DATA VALIDATION & VERIFICATION (DVV)

Essay on M.N.

	Name	Phone	Mail ID	Sign
1)	Shabnam. T. Modali	9022302785	shabnammodali50@gmail.com	Shabnam
2)	Prachi. N. Laxkar	8806244419	prachilaxkar159@gmail.com	Prachi
3)	Archita. A. Mendke	9975034151	madhwarchita@gmail.com	Archita
4)	Ojasvi M. Wankhede	8767699751	wankhedeojasvi@gmail.com	Ojasvi
5)	Ashwini shenwai	9096507459	ashwiniashenwai@gmail.com	Ashwini
6)	Tannu S. Korde	7841984450	kordetannu139@gmail.com	Tannu
7)	Kimaya Kale	8866073792	kimayakale1003@gmail.com	Kimaya
8)	Pranali Ghongajkar	9309079427	pranali2gh@gmail.com	Pranali
9)	Bhagyashree S. Ambule	9359889068	ambuleb66@gmail.com	Ambule
10)	Pallavi B. Patre	8459277408	patre573@gmail.com	Pallavi
11)	Vaishnavi K. Pradhan	9763169560	pradhanvaishnavi155@gmail.com	Vaish
12)	Shrushti. S. Patilkar	7387067403	shrushtipatilkar@gmail.com	Shrushti
13)	Deepika Yadav	0790992162215	dy579@gmail.com	Deepika
14)	Riya. U. Maske	7350980367	maskepriyaz@gmail.com	Riya

15) Sujata Kulkarni

16) Priyak Khawshi

Signature of:

17) Pragya S. Tiwari

18) Kavinc T. Dwe

Programme In-charge

917451202

9763617224

6394098886

9286237796

IQAC Coordinator

INTERNAL QUALITY ASSURANCE CELL
DHARAMPETH M. P. DEO MEMORIAL & SCIENCE COLLEGE, NAGPUR

prajakulkarni15@gmail.com

priyakhawshi3@gmail.com

Pragyatiwari10052003@gmail.com

keatneeldivoz@gmail.com

Pravali

Pratikha

Prinavali

Principal

Principal

Dharampeth M. P. Deo Memorial
Science College, Nagpur.



DHARAMPETH M. P. DEO MEMORIAL SCIENCE COLLEGE, NAGPUR
INTERNAL QUALITY ASSURANCE CELL (IQAC)

Activity Report

Date: 19-09-2022

Name of Organizing Department or Committee: Department of Statistics

Name of the activity: Tossing of coin and determination of probability.

Suggested CRITERION point if any:

Date of Activity: 19th September 2022

Place of Activity: Statistics lab

Name of Guest Speaker/s or Judge/s or Chief Guest/s if any:

Title of the Activity: Tossing of coin and determination of probability.

Number of Participants: 23

Name of the Teacher: Durga hingwe

Names of other Committee Members / Staff: N.A.

OUTCOME of the Activity with respect to mission vision of the institute and or academics:

When we flip a coin there is always a probability to get a head or a tail is 50%. This experiment is designed to help students see that the probability is not the same as reality. However, they should discover that as we do the experiment more times, the results resemble the probability more closely.

Activity with newspaper coverage if any: No

Activity data save in PC of: Department of Statistics

Prof. Pitambar Humane

IQAC Coordinator

CO ORDINATOR

INTERNAL QUALITY ASSURANCE CELL
DHARAMPETH M. P. DEO MEMORIAL
SCIENCE COLLEGE, NAGPUR
CO ORDINATOR

Name & Signature of Teacher In-charge

Dr. Akhilesh Peshwe

Principal

Principal
Dharampeth M.P. Deo Memorial
Science College, Nagpur.



DHARAMPETH M. P. DEO MEMORIAL SCIENCE COLLEGE NAGPUR

Department of Statistics

Class: B.Sc. Sem.- I

NEP ACTIVITY

Paper-1

Unit-1

Name of the Teacher: Durga C. Hingwe

Date: 19-09-22

Title of Activity: Tossing of coin & determination of probability

Sr. No.	Name of Student	Batch	Mobile No.	Email ID	Signature
1.	Dnyani V. Zagade	F2	9022866318	dnyanizagade@gmail.com	<u>Dnyani</u>
2.	Jamni V. Khode	F2	7385066634	Jamni Khode@gmail.com	<u>Khode</u>
3.	Pranali R. Dehanbar	F2	8167581272	Ptehanar@gmail.com	<u>Pranali</u>
4.	Nisha S. Kulkarni	F2	9890996645	nishakulkarni333@gmail.com	<u>Nisha</u>
5.	Utkasha S. Ingale	F2	7499159178	utkashaingale9@gmail.com	<u>Utkasha</u>
6.	Vidya Lohi	F2	7020963219	Vidyalohi8@gmail.com	<u>Vidya</u>
7.	Sankshi Mishra	F2	9529889315	smishra939683@gmail.com	<u>Sankshi</u>
8.	Janhvi Laibey	F2	8446510539	Jhanvilaibey@gmail.com	<u>Janhvi</u>
9.	Rutika Yadav	F2	8466055943	yadavrutika434@gmail.com	<u>Rutika</u>
10.	Mudit Khindkar	F2	9055329557	muditkhindkar@gmail.com	<u>Mudit</u>
11.	Veena Borikar	F2	9322016921	veenaborikar14@gmail.com	<u>Veena</u>
12.	Janhvi Joge	F2	7385060871	Janhvi joge 08@gmail.com	<u>Janhvi</u>
13.	Pranali Aupta	F2	7020069377	23991537@gmail.com	<u>Pranali</u>
14.	Jagruti Fulkawar	F2	826794207	Jagrutifulkawar@gmail.com	<u>Jagruti</u>
15.	Sonia Niwal	F2	7058425024	nawalsonia70@gmail.com	<u>Sonia</u>
16.	Chetna Bureil	F2	8010842968	bureilchetna@gmail.com	<u>Chetna</u>
17.	Devashri Kakde	F2	9021344265	kakde devashri@gmail.com	<u>Devashri</u>
18.	Janhvi Kamapure	F2	7058295243	janhvikamapure@gmail.com	<u>Janhvi</u>
19.	Prachiya Tirpude	F2	8010362232	prachiyatirpude9143@gmail.com	<u>Prachiya</u>
20.	Vivek S. Sah	F1	9923763071	vivek.sah1878@gmail.com	<u>Vivek</u>
21.	Nayan N. Walthare	F1	7841870917	NayanWalthare4@gmail.com	<u>Nayan</u>
22.	Shilpa N. Deshpande	F2	9130091540	shilpandeshpande21004@gmail.com	<u>Shilpa</u>
23.	Varsha L. Turkat	F2	9373650950	Varshaturkat488@gmail.com	<u>Varsha</u>

Durga C. Hingwe
Signature of Teacher

Durga C. Hingwe
Teacher in charge



DHARAMPETH M. P. DEO MEMORIAL SCIENCE COLLEGE, NAGPUR
INTERNAL QUALITY ASSURANCE CELL (IQAC)

Activity Report

Date: 19-09-2022

Name of Organizing Department or Committee: Department of Statistics

Name of the activity: Correlation between height and weight of students in your class.

Suggested CRITERION point if any:

Date of Activity: 19th September 2022

Place of Activity: Statistics lab

Name of Guest Speaker/s or Judge/s or Chief Guest/s if any:

Title of the Activity: Correlation between height and weight of students in your class.

Number of Participants: 18

Name of the Teacher: Gauri Sinekar

Names of other Committee Members / Staff: N.A.

OUTCOME of the Activity with respect to mission vision of the institute and or academics:

Student get the knowledge about correlation and how to relate two different thing on the basis of given data. For this activity, students collect the data of height and weight of their class.

Students know how to analyse data with the help of correlation tool.

Activity with newspaper coverage if any: No

Activity data save in PC of: Department of Statistics

Prof. Pitambar Humane
IQAC Coordinator

CO ORDINATOR
INTERNAL QUALITY ASSURANCE CELL
DHARAMPETH, M. P. DEO MEMORIAL &
SCIENCE COLLEGE, NAGPUR

Name & Signature of Teacher In-charge

Dr. Akhilesh Peshwe
Principal

Principal
Dharampeth M.P. Deo Memorial
Science College, Nagpur.



DHARAMPETH M. P. DEO MEMORIAL SCIENCE COLLEGE NAGPUR

Department of Statistics

Class: B.Sc. Sem.- III

NEP ACTIVITY

Paper- I

Unit I

Name of the Teacher: Gauri Sanjay Sinekar

Date: 19/09/22

Title of Activity: Correlation between height and weight of students in your class.

Sr. No.	Name of Student	Batch	Mobile No.	Email ID	Signature
1	Ratan S. Bhoyar	SCOM	9657958276	ratnabhoys53@gmail.com	
2	Harshal N. Afankar	SCOM	9527732398	Harshalafankar80@in	
3	Isha S. Nemade	SCOM	7028494761	ishanemade72@gmail.com	
4	Vicky A. Singh	SCOM	9834782991	vickyasingh1102001@gmail.com	
5	Suman R. Singh	SCOM	9322018536	sumansinghr12345678@gmail.com	
6	Aman Chavhan	SCOM	7219486153	amanchavhan2@gmail.com	
7	Anjali V. Ranganekar	SCOM	8830031253	anjalianganekar2@gmail.com	
8	Purushottam. Parashar	SCOM	7020693071	parashpurushoth@gmail.com	
9	Sahil B. Singh	SCOM	7252828502	sahilbsingh@gmail.com	
10	Pranjyoti Pawar	SCOM	9350905759	pranjyoti25@gmail.com	
11	Swamini S. Rajankar	SCOM	9822200598	swaminisrajankar@gmail.com	
12	Vrushali shahare	SCOM	9307516332	vicky8singh25@gmail.com	
13	Sarthak Jichkar	SCOM	8605710878	Sarthakjichkar@gmail.com	
14	Anishka A. Bansode	SCOM	2520541758	anishkabansode402@gmail.com	
15	Sumit Sabar	SCOM	9822403882	sumitsabar25@gmail.com	
16	Devang Karia	SCOM	7888238500	devang@gmail.com	
17	Khushi Waghmare	SCOM	9156520783	khushiwaghmare@gmail.com	
18	Umeshwar Jadhav	SCOM	9156910855	umeshwar06593@gmail.com	

G. Sinekar
Signature of Teacher

G. Sinekar
Teacher Incharge



DHARAMPETH M. P. DEO MEMORIAL SCIENCE COLLEGE, NAGPUR
INTERNAL QUALITY ASSURANCE CELL (IQAC)
NEP Activity Report

Date: 20/09/22

Name of Organizing Department or Committee: Chemistry Department

Name of the activity: NEP Activity Report (Sem- I, Unit-I)

Suggested CRITERION point if any: Criteria II

Date of Activity: 19/09/22

Place of Activity: Corridor of Chemistry Department

Name of Guest Speaker/s or Judge/s or Chief Guest/s if any: Nil

Title of the Activity: A) Poster making of Scientist de-Broglie, Heisenberg's, Schrodinger, Aufbau, Pauli's, Hund's with scientist Photographs and inventions. B) Balloon Model of s, p and d shape

Number of Participants: 35

Name of the Teacher In-charge / Convener: Dr. Pranita Gawande, Niharika Sute

Names of other Committee Members / Staff: Dr. Vaishali Meshram

OUTCOME of the Activity with respect to mission vision of the institute and or academics:

This is a student centric activity. In poster presentation students learnt how to communicate any principle in a concise and visually engaging format. This activity helps students to know about scientist and their contribution. Students use their idea for making balloon model to help them figure out how to build their orbitals using balloons.



Activity with newspaper coverage if any: Nil

Activity data save in PC of: Chemistry Department

Note: Kindly share geotag photographs separately along with report on iqacdsc2022@gmail.com

Prof. Pitambar Humane
IQAC Coordinator

CO ORDINATOR
INTERNAL QUALITY ASSURANCE CELL
DHARAMPETH, M. P. DEO MEMORIAL &
SCIENCE COLLEGE, NAGPUR

Name & Signature of Teacher In-charge

Dr. Pranita Gawande

Dr. Akhilesh Peshwe
Principal

PRINCIPAL
Dharampeth M. P. Deo Memorial
Science College, Nagpur-440033



DHARAMPETH M. P. DEO MEMORIAL SCIENCE COLLEGE,
North Ambazari Road, Near Ambazari Lake, Nagpur-440033

DATA VALIDATION & VERIFICATION (DVV)

Name of the Programme : NEP Activity - 1 on Unit - I (sem - I)
 Date of the Programme : A) poster making of scientist de-Broglie, Heisenberg's, Schrodinger, Aufbau, Pauli, Hund's with scientist photographs and inventions. (B) Button made by S.P. & d shape
 Name of Chief Guest if any : 19/09/22
 Name of Guest Speaker if any : _____

Sr. No.	Name of the Participant	Mobile Number	E-mail Id	Signature
1.	Shital. O. Patle	9764596337	shitalpatle@gmail.com	Spalte.
2.	Ritika Bhojare	9834587087	ritikabhoyar28@gmail.com	Ritika
3.	Monika Patel	7499225468	Monika Patel 1938@gmail.com	Monika Patel
4.	Sansabh Chaudhary	9359883501	schaudhary5599@gmail.com	Sansabh
5.	Ruchi Dwivedi	8080776893	Ruchidwivedi23@gmail.com	Ruchi
6.	Aakansha mairal	8030923662	aakanshagiri2004@gmail.com	Aakansha
7.	Durgesh Ghodmare	9075318618	durgeshghodmare001@gmail.com	Durgesh
8.	Karishma .N. Prasad	9309378667	narendrprasad72@gmail.com	Karishma
9.	Pawan G. Thakre	8262968719	thakrepawan789@gmail.com	P.G. Thakre
10.	Pratibha Bhusari	7821048413	pbhusari718@gmail.com	Pratibha
11.	Shivam Patel	7098889083	sp040263@gmail.com	Shivam
12.	Ankit Patel	9970908638	ankitpatel79727r@gmail.com	Ankit Patel
13.	Shreya Sha	8983236602	sangeetah036@marl.com	Shreya
14.	Arjun SHARMA	7020107398	arjun7010sharma@marl.com	Arjun Sharma

Buy
Signature of:
Programme in-charge

ICAC Coordinator
CO ORDINATOR

INTERNAL QUALITY ASSURANCE CELL
DHARAMPETH, M. P. DEO MEMORIAL &
SCIENCE COLLEGE, NAGPUR

Principal
Principal
PRINCIPAL

Dharampeth M.P. Deo Memorial
Science College, Nagpur-440033



DHARAMPETH M. P. DEO MEMORIAL SCIENCE COLLEGE,
North Ambazari Road, Near Ambazari Lake, Nagpur- 440033

DATA VALIDATION & VERIFICATION (DVV)

15	Priya hubey [CBM (F13)]	866948 5362	dubeynameshpriya@gmail.com	Prabhakar
16	Aneksha D. Kulagale [CBM]	7559455796	anekshakulagale@gmail.com	A. Khatwale
17	Lucky A. Vishwakarma [CB]	9579660186	lvishwalcarma4@gmail.com	L. Vishwakarma
18	Rohan M. Meshram [CB]	7499956761	rohanmeshram49@gmail.com	R. Meshram
19	Samyak M. Hadke [CB]	7020171304	Samyakhadke30@gmail.com	S. Meshram
20	Jeet S. Pardhi (C21F14)	2626215431	Jeet.pardhi11@gmail.com	Jeet Pardhi
21)	Ankit Patel	4970965638	ankitpatel74727@gmail.com	A. Patel
22)	shruti channekur (FIS)	9699823842	shrutichannekur76@gmail.com	S. Channekur
23	Umang Warthi (FIS)	9322428500	umangwarthi@gmail.com	U. Warthi
24)	Neha L. Wanjari (FIS)	9373832266	neha.wanjari73@gmail.com	N. Wanjari
25)	Kantika M. Deshmukh	9699720460	kantikamdz@gmail.com	K. Deshmukh
26)	Mooja B. Bisen (FIS)	8483097439	moojabisen254@gmail.com	M. Bisen
27)	pratiksha M. Meshram (FIS)	8459070338	meshrampratiksha@gmail.com	P. Meshram
28)	pranali Y. Chavhare (FIS)	9699659562	pranalicchavhare@gmail.com	P. Chavhare
29)	Yachana K. Pandey	9156035297	pandeykms4@gmail.com	Y. Pandey
30)	priya B. Sharma	8010764549	priya19012004sharma@gmail.com	P. Sharma
31	Ritika R. Sandhiya (FIS)	9175581655	ritikasandhi@gmail.com	R. Sandhiya
32	Muskan V. Kulkarni	9156889239	muskan.kulkarni24@gmail.com	M. Kulkarni
33	Krutika Pakule	9021533341	pakulekrutika@gmail.com	K. Pakule
34	Chamchal K. Waghmare	7796016894	waghmarechamchal@gmail.com	C. Waghmare
35	Vaidehi P. Thote	7558594191	vaidehitote27@gmail.com	V. Thote

Signature of:
Programme In-charge

IQAC Coordinator
CO-ORDINATOR

INTERNAL QUALITY ASSURANCE CELL
DHARAMPETH, M. P. DEO MEMORIAL &
SCIENCE COLLEGE, NAGPUR

Principal
PRINCIPAL

Dharampeth M. P. Deo Memorial
Science College, Nagpur-440033



DHARAMPETH M. P. DEO MEMORIAL SCIENCE COLLEGE, NAGPUR
INTERNAL QUALITY ASSURANCE CELL (IQAC)
Activity Report NEP

Date: 30/09/2022

Name of Organizing Department or Committee: Home science Department

Name of the activity: Preparation of Tube Feedings for ICU patients.

Suggested CRITERION point if any:

Date of Activity: 20/09/2022

Place of Activity: Home Science Department

Name of Guest Speaker/s or Judge/s or Chief Guest/s if any:

Title of the Activity: Preparation of Tube Feedings for ICU patients.

Number of Participants: 18

Name of the Teacher In-charge / Convener: Mrs Pradnya Bagalkote.

Names of other Committee Members / Staff: HOD Manju Deshpande ma'am

OUTCOME of the Activity with respect to the mission vision of the institute and or academics:

Students learnt new concept of therapeutic diets i.e. Tube Feedings which is crucial part of treatment of ICU patients.

Activity with newspaper coverage if any: ''''

Activity data save in PC of:

Note: Kindly share geotag photographs separately along with report on igacdsc2022@gmail.com



Prof. Pitambar Humane
CO ORDINATOR
INTERNAL QUALITY ASSURANCE CELL
DHARAMPETH, M. P. DEO MEMORIAL &
SCIENCE COLLEGE, NAGPUR

Name & Signature of Teacher In-charge

Dr. Akhilesh Peshwe
Principal
Principal
Dharampeth M.P. Deo Memorial
Science College, Nagpur.



DHARAMPETH M. P. DEO MEMORIAL SCIENCE COLLEGE,
North Ambazari Road, Near Ambazari Lake, Nagpur- 440033

Ryles Tube Feeding
NEP.

DATA VALIDATION & VERIFICATION (DVV)

20/9/2022 Sem V

1.	Sushmita Mallick	9837916560	sushmita100@gmail.com	Sushmita
2.	Ananya Meghree	9284834439	ananyaMeghree@gmail.com	Ananya
3.	Mahira Wankhede	7821883251	mahirawankhede7@gmail.com	Mahira
4.	Vaishnavi Bahadure	9284679244	Vaishnavibahadure3@gmail.com	Vaishnavi
5.	Mayuri Mali	7498065023	PushpaNali1947@gmail.com	Mayuri
6.	Ananya A. Meghree	9284834439	ananyaMeghree@gmail.com	Ananya
7.	Aarti Raut	8625813184	araut76@gmail.com	Aarti
8.	Sakshi Thorat	8177911860	Sakshithorak620@gmail.com	Sakshi
9.	Vanshika D Todare	4511744575	vanshika@gmail.com	Vanshika
10.	Aashi Ramteke	8983345716	aashiramteke7@gmail.com	Ramteke
11.	Riya Sherkar	7249070278	sherkarriya@gmail.com	Riya
12.	Puja Chute	9552381386	laxmichute123@gmail.com	Puja

Signature of:

Program In-charge

COORDINATOR
IQAC COORDINATOR
DHARAMPETH M. P. DEO MEMORIAL &
SCIENCE COLLEGE, NAGPUR

Principal
Dharampeth M.P. Deo Memorial
Science College, Nagpur.



DHARAMPETH M. P. DEO MEMORIAL SCIENCE COLLEGE, NAGPUR
INTERNAL QUALITY ASSURANCE CELL (IQAC)

Activity Report

Date: 20-09-2022

Name of Organizing Department or Committee: Department of Statistics

Name of the activity: Verification of fitting of normal distribution to bivariate data.

Suggested CRITERION point if any:

Date of Activity: 20th September 2022

Place of Activity: Statistics lab

Name of Guest Speaker/s or Judge/s or Chief Guest/s if any:

Title of the Activity: Verification of fitting of normal distribution to bivariate data.

Number of Participants: 18

Name of the Teacher: Gauri Sinekar

Names of other Committee Members / Staff: N.A.

OUTCOME of the Activity with respect to mission vision of the institute and or academics:

Student get the knowledge about Normal Distribution. Students verify whether normal distribution is fitted to given data or not. How to analyse two variable on the basis of given data.

Activity with newspaper coverage if any: No

Activity data save in PC of: Department of Statistics

Prof. Pitambar Humane
IQAC Coordinator

CO ORDINATOR
INTERNAL QUALITY ASSURANCE CELL
DHARAMPETH, M. P. DEO MEMORIAL &
SCIENCE COLLEGE, NAGPUR

Name & Signature of Teacher In-charge

Dr. Akhilesh Peshwe
Principal

Principal
Dharampeth M.P. Deo Memorial
Science College, Nagpur



DHARAMPETH M. P. DEO MEMORIAL SCIENCE COLLEGE NAGPUR

Department of Statistics

Class: B.Sc. Sem. - III

NEP ACTIVITY

Paper- I

Unit II

Name of the Teacher: Gauri S. Sinekar

Date: 20/09/22

Title of Activity: Verification of fitting of normal distribution to bivariate data.

Sr. No.	Name of Student	Batch	Mobile No.	Email ID	Signature
---------	-----------------	-------	------------	----------	-----------

1	Katun S. Bhojar	SCOM	9657957276	katunbhojar53@gmail.com	<u>Katun</u>
2	Harshal N. Atarkar	SCOM	952 7732 358	harshalnatarakar@gmail.com	<u>H.N.A. Atarkar</u>
3	Isha S. Nemade	SCOM	7028494761	ishanemada.72@gmail.com	<u>Ishma</u>
4	Vicky A. Singh	SCOM	9834782931	vickyasingh1103@gmail.com	<u>Vicky</u>
5	Suman R. Singh	SCOM	9322018536	suman.r.singh2345678@gmail.com	<u>Suman</u>
6	Satish B. Singh	SCOM	7258868902	satishb@gmail.com	<u>Satish</u>
7	Aman D. Chavhan	SCOM	7219486155	amanchavhan@gmail.com	<u>Aman</u>
8	Anjali V. Rangankar	SCOM	8830691253	anjali.rangankar@gmail.com	<u>Anjali</u>
9	Vrushali Shohare	SCOM	9307516332	vrushalishohare@gmail.com	<u>Vrushali</u>
10	Prajakta Pawar	SCOM	9356905759	prajakta24@gmail.com	<u>Prajakta</u>
11	Swamini S. Rajankar	SCOM	9822200598	swaminirajankar@gmail.com	<u>Swamini</u>
12	Purushottam Parash	SCOM	702069307	purushottam	<u>Purushottam</u>
13	Santhak Jichkan	SCOM	8605710878	santhakjichkan@gmail.com	<u>Santhak</u>
14	Aishikhan H Bamsed	SCOM	7820541763	aishikhanbamsed@gmail.com	<u>Aishikhan</u>
15	Somit Salole	SCOM	9322110388	somitsalole@gmail.com	<u>Somit</u>
16	Deviang Karia	SCOM	788823850	deviang@gmail.com	<u>Deviang</u>
17	Khushi Waghade	SCOM	9156520783	khushiwaghade@gmail.com	<u>Khushi Waghade</u>
18	Aishwari Sudhav	SCOM	9156916355	v50806593@gmail.com	<u>Aishwari</u>

G. Sinekar
Signature of Teacher

G. Sinekar
Teacher Incharge



DHARAMPETH M. P. DEO MEMORIAL SCIENCE COLLEGE, NAGPUR
INTERNAL QUALITY ASSURANCE CELL (IQAC)

Activity Report

Date: 30.09.2022

Name of Organizing Department or Committee: Dept. of Home Science

Name of the activity: Development of Health Education Aid – Slogan writing (NEP 2022 Activity)

Suggested CRITERION point if any:

Date of Activity: 20.09.2022

Place of Activity: Classroom, Dept. of Home Science

Name of Guest Speaker/s or Judge/s or Chief Guest/s if any:

Title of the Activity: Slogan to highlight the bad effects of Smoking OR alcoholism OR drug addiction

Number of Participants: 14

Name of the Teacher In-charge / Convener: Mrs. Meghna Pandit

Names of other Committee Members / Staff:

OUTCOME of the Activity with respect to mission vision of the institute and or academics:

Development of innovative ideas and creativity and practical application of subject.

Activity with newspaper coverage if any:

Activity data save in PC of:

Note: Kindly share geotag photographs separately along with report on iqacdsc2022@gmail.com

Prof. Pitambar Humane

IQAC Coordinator

CO ORDINATOR
INTERNAL QUALITY ASSURANCE CELL
DHARAMPETH, M. P. DEO MEMORIAL &
SCIENCE COLLEGE, NAGPUR

mfandit

Name & Signature of Teacher in-charge
(Mrs. Meghna Pandit)

Dr. Akhilesh Beshwe
HEAD OF DEPARTMENT
DEPT. OF HOME SCIENCE
DHARAMPETH, M. P. DEO
MEMORIAL SCIENCE COLLEGE
NAGPUR



DHARAMPETH M. P. DEO MEMORIAL SCIENCE COLLEGE,
North Ambazari Road, Near Ambazari Lake, Nagpur-440033

DATA VALIDATION & VERIFICATION (DVV)

Name of the Programme

Development of Health Education Aid - Slogan writing

Date of the Programme

20/09/2022

Name of Chief Guest if any

Name of Guest Speaker if any

Sr. No.	Name of the Participant	Mobile Number	E-mail Id	Signature
1.	Sushmita Mallick	9387916560	sushmita1960@gmail.com	Sushmita
2.	Ananya Meghse	9284830439	ananya.meghse@gmail.com	Ananya
3.	Mayurvi Mali	7498065023	Mayurvimali1993@gmail.com	Mali
4.	Mahima Wankhede	7821883251	Mahimawankhede7@gmail.com	Mahima
5.	Sakshi Thosar	8177911360	sakshithosar620@gmail.com	S.Thosar
6.	Poonali Raut	9130117015	poonaliraut567@gmail.com	Poonali
7.	Vaishnavi Bahadure	9284679244	vaishnavibahadure34@gmail.com	Vaishnavi
8.	Vishnavi Upasak	9975287431	upasak.vishnavi@gmail.com	Vupasak
9.	Renuka Raut	8855972285	raut.renuka85@gmail.com	Renuka
10.	Riya Sheekare	7249070278	Sheekare042@gmail.com	Riya

Signature of:

Mandit
Programme In-charge

COORDINATOR
INTERNAL QUALITY ASSURANCE CELL
DHARAMPETH M. P. DEO MEMORIAL &
SCIENCE COLLEGE, NAGPUR

PRINCIPAL
Dharampeth M. P. Deo Memorial
Science College, Nagpur-440033



DHARAMPETH M. P. DEO MEMORIAL SCIENCE COLLEGE,
North Ambazari Road, Near Ambazari Lake, Nagpur- 440033

DATA VALIDATION & VERIFICATION (DVV)

11.	Aashi Ramteke	8983345716	aashiramteke7@gmail.com	Aashi
12.	Aarti Raut	8625813184	rauto0309@gmail.com	Aarti
13.	Vanshika Todare	7447275658	vanshikatodare@gmail.com	Vanshika

Signature of

Programme In-charge

IQAC Coordinator

PRINCIPAL
Dharampeth M.P. Deo Memorial
Science College, Nagpur-440033



Activity Report

Date: 21. Sep., 2022

Name of Organizing Department or Committee: BOTANY DEPARTMENT

Name of the activity: Study of Bryophytes

Suggested CRITERION point if any: CRITERION-1

Date of Activity: 21st Sep., 2022

Place of Activity: DHARAMPETH M.P. DEO MEMORIAL SCIENCE COLLEGE

Name of Guest Speaker/s or Judge/s or Chief Guest/s if any: Prof. Pitambar Humane

Title of the Activity: To collect identify and describe some common bryophytes in and around college campus and residence.

Number of Participants: 21

Name of the Teacher In-charge / Convener: Mr. Amol Pimpalshende

Names of other Committee Members / Staff: Dr. Chandrakumar Patle, Dr. Mrs. Sweta Rai & Mrs. Dipali Nikure

OUTCOME of the Activity with respect to mission vision of the institute and or academics: Field study understood the students that the various types of Bryophytes found in college campus and residence. They help to understand and distinguish to identify the bryophytes among thallophytes and cryptogams. The interest and concentration of the students increases in the subject due to Study of plant diseases in and around college campus.

Activity with newspaper coverage if any: NA

Activity data save in PC of: Mr. Amol Pimpalshende's Laptop



Prof. Pitambar Humane CO ORDINATOR
IQAC Coordinator INTERNAL QUALITY ASSURANCE CELL
DHARAMPETH, M. P. DEO MEMORIAL &
SCIENCE COLLEGE, NAGPUR

Name & Signature of Teacher In-charge

Dr. Aklifesh Peshwe
Principal Principal
Dharampeth M.P. Deo Memorial
Science College, Nagpur.



DHARAMPETH M. P. DEO MEMORIAL SCIENCE COLLEGE,
North Ambazari Road, Near Ambazari Lake, Nagpur- 440033

DATA VALIDATION & VERIFICATION (DVV)

Name of the Programme : To collect, identify and described some common Bryophytes in our college campus or veridex.

Date of the Programme : 21/9/22

Name of Chief Guest if any : _____

Name of Guest Speaker if any : _____

Sr. No.	Name of the Participant	Mobile Number	E-mail Id	Signature
1.	Pravindra Khulse	8007198273	khulpravindra9392@gmail.com	
2.	Nishi R. Rai	7058638984	nishirai1419@gmail.com	
3.	Anshul Y. Kishnapure	9284052163	anshulkishnapure55@gmail.com	
4.	Anjali Thakre	7066554821	thakreanjali381@gmail.com	
5.	Komalika Chaudhari	9322033866	KomalikaChaudhari@gmail.com	
6.	Vaishnavi Tonge	8421657943	vaishnavitonge2004@gmail.com	
7.	Khushi Bharti	9604367874	2007 khushi bharti@gmail.com	
8.	Arya Dhoke	9011681628	arya.narmada1331@gmail.com	
9.	Ghanashree V. Dheman	8459807047	ghanshreedheman@gmail.com	
10.	Aparna Mohare	7020649887	aparnamohare2@gmail.com	

Signature of: Aarjya S. Husain

Programme In-charge

IQAC Coordinator

COORDINATOR
INTERNAL QUALITY ASSURANCE CELL
DHARAMPETH, M. P. DEO MEMORIAL &
SCIENCE COLLEGE, NAGPUR

Principal

Dharampeth M.P. Deo Memorial
Science College, Nagpur.



DHARAMPETH M. P. DEO MEMORIAL SCIENCE COLLEGE,
North Ambazari Road, Near Ambazari Lake, Nagpur- 440033

DATA VALIDATION & VERIFICATION (DVV)

14	Aarti K. Kharole	9579745628	aartikharole@gmail.com	Aarti
13	Ashwini A. Lanjewar	968911759	lanjewarashwini777@gmail.com	Ashwini
14	Ghanashree U. Dhokane	8459807047	ghanashreedhokane@gmail.com	Ghanashree
15	Nisha V. Pandey	8605231390	nishavk0605231390@gmail.com	Nisha
16	Lucky A Vishwakarma	9579660188	Lushwakarma@gmail.com	Lushwakarma
17	Kalyani B. Sindram	846531622	kalyanisindran@gmail.com	
18	Jesal D. Kolhe	8483045985	kolhejesal04@gmail.com	Kolhe
19	Ashay P. Tembhare	8775363145	ashaytembhare@gmail.com	
20	Nitu B. Rai	7058638784	Raitu1419@gmail.com	
21	Aparna Mohare	7020649887	aparnamohare930@gmail.com	

Signature of:

Programme In-charge

IQAC Coordinator
CO ORDINATOR
INTERNAL QUALITY ASSURANCE CELL
DHARAMPETH, M. P. DEO MEMORIAL &
SCIENCE COLLEGE, NAGPUR

Principal
Principal
Dharampeth M.P. Deo Memorial
Science College, Nagpur.



DHARAMPETH M. P. DEO MEMORIAL SCIENCE COLLEGE, NAGPUR

INTERNAL QUALITY ASSURANCE CELL (IQAC)

Activity Report

Date: 21/09/2022

Name of Organizing Department or Committee: Department of Physics
Name of the activity: NEP based Demonstration Activity for B.Sc. Semester III (Paper I)
Suggested CRITERION point if any: Restricted to RTMNU B.Sc. physics syllabus.
Date of Activity: 21/09/2022
Place of Activity: Room no. 004
Name of Guest Speaker/s or Judge/s or Chief Guest/s if any: NA
Title of the Activity: Demonstration on conversion of sound into electrical energy
Activity with newspaper coverage if any: No
Number of Participants: B.Sc. Semester III Students – 43
Name of the Teacher In-charge / Convener: Dr. Nayana Sonwane
Names of other Committee Members / Staff: N.A.

OUTCOME of the Activity with respect to academics:

This demonstration let the students to experience the mechanism of the handy devices based on the conversion of sound energy into electrical energy. The mobile phone as a very familiar device was taken for the demonstration. The sound signal given by the students in the sound recording app was stored in the mobile and played the same after storage. The phenomenon of conversion was explained to the students in details. Moreover, the loud speaker is taken which is then connected to CRO inputs and LED. On speaking, the CRO shows different patterns and the LED glows with intensity of the voice at the input side.

DVV: Enclosed.

Activity data save in PC of: Lt. Dr. P. W. Ambekar

Prof. Pitambar Humane
IQAC Coordinator

CO ORDINATOR
INTERNAL QUALITY ASSURANCE CELL
DHARAMPETH, M. P. DEO MEMORIAL &
SCIENCE COLLEGE, NAGPUR

Name & Signature of Teacher In-charge

Dr. Akhilesh Peshwe
Principal

Principal
Dharampeth M.P. Deo Memorial
Science College, Nagpur.



DHARAMPETH M. P. DEO MEMORIAL SCIENCE COLLEGE NAGPUR

Department of Physics

NEP ACTIVITY

Class: B.Sc. Sem. - III

Paper- I

Unit- 2

Name of the Teacher: Dr. N. Sonwane

Date: 21/09/22

Title of Activity: Demonstration on conversion of sound into elec

Sr. No.	Name of Student	Batch	Mobile No.	Email ID	Signature
---------	-----------------	-------	------------	----------	-----------

1	Mansi Ashok Budole	S-8	7796308467	mansibudol@gmail.com	<u>Mansi</u>
2	Kajal Tilakdhari Prasad	S-8	7410763139	prasadkajal2004@gmail.com	<u>Kajal</u>
	Kajal P. Nighat	S-8	7373250623	kajalnighat2000@gmail.com	<u>Kajal</u>
	Shruti N. Rorntoke	S-9	8857031895	20shru1981@gmail.com	<u>Shruti</u>
	Jitendra R. Rutane	S-8	9657454925	Jitendra.rutane0130@gmail.com	<u>Jitendra</u>
6)	Atharav P. Umate	S-5	9264641511	atharavumate@gmail.com	<u>Umate</u>
7)	Abhina Vireal Ingule	S-7	9027468630	abhaviringle23@gmail.com	<u>Ingule</u>
8	Jasraj Devidas Palival	S-8	9370820325	jasrajpalival112@gmail.com	<u>Jasraj</u>
9)	Ayush R. Basilkar	S-5	9519445072	ayushbasilkar45@gmail.com	<u>Ayush</u>
10)	Ausmin K. Sheikh	S-3	8668323528	ausmin15029@gmail.com	<u>Ausmin</u>
11)	Mansi Sham Fating	S-8	8767154686	mansyfating2110@gmail.com	<u>Fating</u>
12)	Pratyaksh S. Shah	S-3	7385797365	ps3347311@gmail.com	<u>Pratyaksh</u>
13	Ritul K. Bisen	S-5	7028810840	ritulbisen06@gmail.com	<u>Bisen</u>
14	Shweta Bedwal	S-9	8080440154	shweta.bedwal2605@gmail.com	<u>Shweta</u>
15)	Anuj H. Mishra	S-5	8103656208	anujmishra261202@gmail.com	<u>Anuj</u>
16)	Sakshi Ingle	S-9	9067877694	inglesakshi708@gmail.com	<u>Ingle</u>
17)	Simran Tammar	S-10	7972530337	simrantammar@gmail.com	<u>Simran</u>
18)	Nutan Surjuse	S-5	8805570277	nutansurjuse2@gmail.com	<u>Nutan</u>
19)	Aditi Lute	S-5	7820812303	aditilute161@gmail.com	<u>Aditi</u>
20)	Ananya R. Molghat	S-7	7219218955	ananya.molghat@gmail.com	<u>Ananya</u>
21)	Apurva S. Verutkar	S-7	9623673911	apurva.verutkar@gmail.com	<u>Verutkar</u>
22)	Damini Katre	S-5	8208255685	damini.katre@gmail.com	<u>Damini</u>
23)	Bhagyashree Thakre	S-5	8766925275	thakrebhagyashree@gmail.com	<u>Thakre</u>
24	Nupur Shasna	S-8	8822042259	nupurshasna23@gmail.com	<u>Nupur</u>
25	Prachit R. Kotpallikar	S-9	7498102097	prachitkotpallikar@gmail.com	<u>Prachit</u>
26)	Prakhar Bhatkar	S-3	8329760853	prakhar.bhatkar@gmail.com	<u>Prakhar</u>
27)	Kunal Dighe	S-5	8010294303	kunaldighe@gmail.com	<u>Kunal</u>

Signature of Teacher

Head of Department

- 28) Nitin A. Kumbhar S-5 9693429005 nitinkumbhar2006@gmail.com N.K.
- 29) Adityakumar munda S-5 9518994636 adityakumb0028@gmail.com A.K.
- 30) Divya Hanote S-8 8605422901 divyahanote0406@gmail.com Divya
- 31) Komal patle S-8 ~~patle~~ 9881748506 Komal patle234@gmail.com Komal
- 32) Chetan Bopche S-3 9172494628 chetanbopche23@gmail.com Chetan
- 33) Bhumika V. Thakre S-7 7212247917 Bhumikathakre25@gmail.com Bhumika-7
- 34) Sanchita Raut S-5 7218079074 sanchitapatri12003@gmail.com Sanchita
- 35) Vrushali shahare S-1 9307516332 vrushalishahare25@gmail.com Vrushali
- 36) Dhammaprithi Lode S-7 9975037356 dhammaprithi
prithi@gmail.com Dhammaprithi
- 37) Rushali D. Bhoskar S-9 9579485597 bhoskarrushali@gmail.com Rushali
- 38) Akshay P. Khandare S-5 7350956863 akshaypkhandare73@gmail.com Akshay
- 39) Hitesh G. Baware S-5 7058427112 hiteshbaware72@gmail.com Hitesh
- 40) Hritik C. Mishra S-5 907445777 Kumerianurrdha mishra lolo@gmail.com Hritik
- 41) Omkumar D. Devnagan S-5 9963624588 ommamaji12@gmail.com Omkar
- 31
- 36) Adityakumar Singh S-5 7350543901 adityaSingh22818@gmail.com A.K.S
- 37) Dinesh Parteti S-7 9623399676 Partetidinesh51@gmail.com Dinesh
- 38) Rohit S. Wanjari S-9 7741061907 wanjarirohit@gmail.com Rohit
- 39) Pratik D. Lihare S-9 9307480208 PratikLihare3@gmail.com Pratik
- 40) Mithilesh Prasad S-8 97558719534 pmithilesh343@gmail.com Mithilesh
- 41) Ayaz Sheikh S-7 8767355503 ayazs9068@gmail.com Ayaz
- 42) Vatan S. Sowame S-9 9975410765 VatanSowame@gmail.com Vatan
- 43) Vaishu S. Nimje S-9 9599993869 vaishunimje2002@gmail.com Vaishu

 HEAD
 DEPARTMENT OF PHYSICS
 Dharampeth M. P. Deo Memorial
 Science College, Nagpur



DHARAMPETH M. P. DEO MEMORIAL SCIENCE COLLEGE, NAGPUR

INTERNAL QUALITY ASSURANCE CELL (IQAC)

Activity Report
(NEP-2022-23)

Date: 22/09/2022

Name of Organizing Department or Committee: Zoology

Name of the activity: Workshop on vermicomposting without earthworm

Suggested CRITERION point if any: Criteria I

Date of Activity: 22/09/2022

Place of Activity: Zoology laboratory

Name of Guest Speaker judge/s or Chief Guest/s if any: Dr. Snehal N. Dapke

Title of the Activity: Workshop on vermicomposting without earthworm

Number of Participants: 50

Name of the Teacher In-charge / Convener: Dr. K. M. Paturkar

Names of other Committee Members / Staff: Dr. K. M. Paturkar students of Zoological Society

OUTCOME of the Activity with respect to mission vision of the institute and or academics:

- Students actively participated in this activity and understand the process of composting without the earthworms.
- By using this knowledge students implement it at their residence.
- Student gets experience of composting by using household nutritional waste.
- The biodegradable matter is used for this activity can helps to solve the problem of waste management at the local level.
- Compost generated by this activity is utilised for the plants and shrubs in the college campus.

Activity with newspaper coverage if any: NIL.

Activity data save in PC of: Zoology Department/personal laptop



[Handwritten Signature]
Dr. Kirti Paturkar

[Handwritten Signature]
Dr. Snehal Dapke

Name & Signature of Teacher In-charge

**DEPARTMENT OF ZOOLOGY,
 DHARAMPETH M. P. DEO MEMORIAL
 SCIENCE COLLEGE, NAGPUR.**

[Handwritten Signature]

Prof. Pitambar Humane

IQAC Coordinator

**CO ORDINATOR
 INTERNAL QUALITY ASSURANCE CELL
 DHARAMPETH, M. P. DEO MEMORIAL
 SCIENCE COLLEGE, NAGPUR**

[Handwritten Signature]

Dr. Akhilesh Peshwe

**Principal
 Principal**

**Dharampeth M. P. Deo Memorial
 Science College, Nagpur**



DHARAMPETH M. P. DEO MEMORIAL SCIENCE COLLEGE,
North Ambazari Road, Near Ambazari Lake, Nagpur- 440033
DATA VALIDATION & VERIFICATION (DVV)

Name of the Programme : Workshop on Vermicomposting without earthworms.
Date of the Programme : 22 / 9 / 2022
Name of Chief Guest if any : _____
Name of Guest Speaker if any : Dr. Snehal N. Dapke.

Sr. No.	Name of the Participant	Mobile Number	E-mail Id	Signature
1.	Pranali Yashwanth Chauhan	9699654562	pranali.chauhan69@gmail.com	Pranali
2.	Neha Lalchand Wanjari	9373832266	nehawanjari733@gmail.com	Neha
3.	Pratiksha Mangal Meshram	8459070338	meshrampratiksha14@gmail.com	Pratiksha
4.	Krutika Subhash Pokale	9021533341	pokalekrutika6@gmail.com	Krutika
5.	Siddhi Bhagwat Yiwari	8084143696	siddhityiwari9721@gmail.com	Siddhi
6.	Dhanashri Neware	9359904913	dhanashrineware@gmail.com	Dhanashri
7.	Aakansha maital	8020923662	aakanshayogi@gmail.com	Aakansha
8.	Muskan Yadav	9579492617	muskan.yadav125@mail.ru	Muskan
9.	Vasishnavi Sarason Bedade	8657188093	vasishnavibedade100@gmail.com	Vasishnavi
10.	Nilesh Hulke	8624091652	nilesh.hulke2003@gmail.com	Nilesh
11.	Dakshana Madavi	8830146516	dmkrunamadavi@gmail.com	Dakshana
12.	Jagruti Warkar	7447366023	jagrutiwarkar09@gmail.com	Jagruti
13.	Juhi Chaudhari	8669248944	chaudharijuhi20@gmail.com	Juhi
14.	Mansi Mate	8468891807	mansi19122@gmail.com	Mansi

Signature of _____
Programme in-charge

IQAC Coordinator
IQAC Co-ordinator
Dharampeth M. P. Deo Memorial
Science College, Nagpur-440033

Principal
Dharampeth M. P. Deo Memorial
Science College, Nagpur-440033



DHARAMPETH M. P. DEO MEMORIAL SCIENCE COLLEGE,
North Ambazari Road, Near Ambazari Lake, Nagpur- 440033

DATA VALIDATION & VERIFICATION (DVV)

Sr. No.	Name of the Participant	Mobile Number	E-mail Id	Signature
1.	Ashalesha Khadgi	8830414264	Aepalikhadgi25@gmail.com	Ashalesha.K
2.	Sunaina Chichonde	8530970132	Sunainachichonde@gmail.com	Sunaina
3.	Gunjan J. Bhojwar	7666799586	gunjanbhojwar04@gmail.com	gunjan
4.	Khushi S. Bhandi	9604367894	2003khushibhandi@gmail.com	khushi
5.	Nikita S. Das.	8446297886	nikitadas970@gmail.com	nikita
6.	Devanshikha D. Bisen	7767861221	Devanshikha bisen 21@gmail.com	Devanshikha
7.	Khushabha H. Chaudhari	7262074960	khushabha.chaudhari30@gmail.com	Khushabha
8.	Dolly P. Sonkawade	7020626933	dolly1910.sonkawade@gmail.com	Dolly
9.	Asmita D. Chougale	7387005732	asmitachougale@gmail.com	Asmita
10.	Sakshi S. Choudhary	8766852462	Sakshichoudhary77993@gmail.com	Sakshi
11.	Rashi R. Satpute	9145486983	rashisatpute77@gmail.com	Rashi

Signature of: Programme in-charge

IQAC Coordinator
Dharampeth M. P. Deo Memorial
Science College, Nagpur-440033

Principal
Dharampeth M. P. Deo Memorial
Science College, NAGPUR.



DHARAMPETH M. P. DEO MEMORIAL SCIENCE COLLEGE,
North Ambazari Road, Near Ambazari Lake, Nagpur- 440033

DATA VALIDATION & VERIFICATION (DVV)

Sr. No.	Name of the Participant	Mobile Number	E-mail Id	Signature
1.	Gawari Ramesh Bhoyare	8668335876	bhoyaregawari754@gmail.com	
2	Jeet Subhash Patilki	7020215431	jeet.spatilki111@gmail.com	
3	Samyak Madhukar Hadke	7020171304	samyakhadke20@gmail.com	
4	Lucky A Vishwakarma	9579660186	lvvishwakarma289@gmail.com	
5)	Poham. H Meshram	74799956761	pohammeshram59@gmail.com	
6)	Minamshi Kamhande	9665301444	kamhandeminamshi@gmail.com	
7)	Rashi R. Patpute	9763941509	rashipatpute77@gmail.com	
8)	Priya B. Sharma	8010764549	priya19012004sharma@gmail.com	
9)	Sakshi Chaudhary	8766852462	Sakshichaudhary127333@gmail.com	
10)	Rishika R. Kokate	9637554918	kokaterishika13@gmail.com	
11)	Yashraj K. Pandey	9156035297	pandeykr54@gmail.com	
12)	Abhishek D. Deshbhakar	8208302902	abhishekdeshbhakar@gmail.com	
13)	Sakshi S. Meshram	9145355733	meshramsakshi14@gmail.com	
14)	Gargi Wadge	7972076671	gargiwadge@gmail.com	
15)	Vaishnavi Wadge	9022976449	wadgevaishnavi00@gmail.com	
16)	Prajwal Bhoyar.	8010434634	Prajwalb738@gmail.com	
17)	Shubham Bisen	7448288545	shubham01bisen@gmail.com	

Signature of
Programme In-charge

IQAC Coordinator
IQAC Co-ordinator

Dharampeth M.P. Deo Memorial
Science College, Nagpur-440033

Principal

Dharampeth M. P. Deo Memorial
Science College, NAGPUR.



DHARAMPETH M. P. DEO MEMORIAL SCIENCE COLLEGE,
North Ambazari Road, Near Ambazari Lake, Nagpur- 440033

DATA VALIDATION & VERIFICATION (DVV)

Sr. No.	Name of the Participant	Mobile Number	E-mail Id	Signature
1.	Vaidhi P. Thale	9558499191	vaidhithale27@gmail.com	Vaidhi
2.	Kartika N. Deshmukh	9699720460	kartikamd20@gmail.com	Kartika
3.	Khan K. Ghughuskar	9823710569	ghughuskar.khan2004@gmail.com	Khan
4.	Sejal D. Kolhe	8483045985	kolhesejal04@gmail.com	Kolhe
5.	Nikhil R. Raut	9022680159	rautn5541@gmail.com	Raut
6.	Aditya W. Dewlkar	9028915776	dewlkaraditya21@gmail.com	Dewlkar
7.	Ankita M. Mishra	8421293176	mishraankita4683@gmail.com	Ankita
8.	Arash P. Aisen	8698119078	dkbisent19@gmail.com	Aisen

Signature of:
Program In-charge

IQAC Coordinator
Dharampeth M.P. Deo Memorial
Science College, Nagpur-440033

Principal
Dharampeth M. P. Deo Memorial
Science College, NAGPUR



DHARAMPETH M.P. DEO MEMORIAL SCIENCE COLLEGE, NAGPUR
ROTARACT CLUB OF DMPDSVM
Activity Report

Date: 30/09/2022

Name of Organizing Department or Committee: Rotaract Club

Name of the Activity: Club Installation Ceremony

Suggested CRITERION point if any: Criterion III & Criterion V

Date of Activity: 23th Sep 2022

Place of Activity: Dr. A. P. J. Abdul Kalam Hall

Name of Guest Speaker/sor Judge/sor Chief Guest/sif any: DG DR. Anand Junjhunuwala,
DRR Saniel Ahmed, Rtr. Vikas Ingale

Title of the Activity: Eykyam

Number of Participants: 21

Name of the Teacher In-charge/Convener: Dr. Mrs. Shraddha Deshpande

Names of other Committee Members/Staff: Rotaract Club Members

OUTCOME of the Activity with respect to mission vision of the institute and or academics:
To install the new team of Rotaract Club and share the vision and mission of the new team to the institute and parent club.

Activity with news paper coverage if any:

Activity data save in PC of: Department of English



Prof. Pitambar Humane
IQAC Coordinator

INTERNAL QUALITY ASSURANCE CELL
DHARAMPETH, M. P. DEO MEMORIAL &
SCIENCE COLLEGE, NAGPUR

Dr. Mrs. Shraddha Deshpande
Teacher In-charge

Dr. Achillesh Peshwe
Principal
Dharampeth M.P. Deo Memorial
Science College, Nagpur.



DHARAMPETH M.P.DEO MEMORIAL SCIENCE COLLEGE, NAGPUR

ROTARACT CLUB 22-23

Installation of the club

23rd September 2023

Instagram Link





**DHARAMPETH M. P. DEO MEMORIAL SCIENCE COLLEGE, NAGPUR
ROTARACT CLUB OF DMPDSVM**

Activity Report

Date: 29/09/2022

Name of Organizing Department or Committee: ROTARACT CLUB OF DMPDSVM

Name of the activity: Sewing Machine Donation

Suggested CRITERION point if any: Criterion III & Criterion V

Date of Activity: 23th September 2022

Place of Activity: A. P. J Abdul Kalam Auditorium

Name of Guest Speaker/s or Judge/s or Chief Guest/s if any: DG Dr. Anand

Junjhunuwala , DRR Saniel Ahemed, Rtr. Vikas Ingale

Title of the Activity: Sewing machine Donation

Number of Participants: 17

Name of the Teacher In-charge / Convener: Dr.Mrs.Shraddha Deshpande

Names of other Committee Members / Staff: Rotaract Members

OUTCOME of the Activity with respect to mission vision of the institute and or academics:

A Community service can improve the lives of different groups of people like troubled children, senior citizens, and people with disabilities. This activity was aimed at helping a woman to earn for her family which was affected during covid. A sewing machine was donated to her wherein she prepares paper bags under the banner Malhar foundation.

Activity with newspaper coverage if any: No

Activity data save in PC of: Department of English

Prof. Pitambar Humane
IQAC Coordinator

CO ORDINATOR
INTERNAL QUALITY ASSURANCE CELL
DHARAMPETH, M. P. DEO MEMORIAL &
SCIENCE COLLEGE, NAGPUR

Dr. Mrs. Shraddha Deshpande
Teacher In-charge

Dr. Akhilesh Peshwe
Principal

Principal
Dharampeth M.P. Deo Memorial
Science College, Nagpur.



**DHARAMPETH M.P.DEO MEMORIAL SCIENCE COLLEGE,
NAGPUR**

ROTARACT CLUB 22-23

Installation of the club

23rd September 2022

List of Students

SR.	NAME	POST	CONTACT NUMBER
1	Harsh kodape	President	9604677672
2	AnanyaMotghare	Secretary	7219218955
3	GargiHadge	Vice President	7972076671
4	Nupur Sharma	Joint Secretary	9322042259
5	PrajwaBhoyar	Sergeant At Arms	8010434634
6	SaniaMidhatRaza	Public Relation Officer	8975726700
7	VaishnaviGadge	International Service	9022976449
8	VedantBaxy	Treasurer	8530455796
9	Aditi Lute	Community service	7820812303
10	RenukaLande	Youth Service	7719951401
11	SanchitaPatil	Professional & Vocational Service	7218079074
12	Dhammapritilale	Member	9975037356
13	AvishkarBansod	Club Administrative	7820841788
14	KhushabuChoudhari	Member	7262074960
15	KartikaDeshmukh	Member	9699720960
16	KunalDigrase	Member	8007525770
17	MuskanKulkarni	Member	9156889239
18	siddhi Tiwari	Member	8087143696
19	MahiThaware	Member	9960625966
20	RitikaSondhiya	Member	9175581655
21	Umangwarthi	Member	9322428500

Prof. Pibamber Humane
IQAC Coordinator

CO ORDINATOR
INTERNAL QUALITY ASSURANCE CELL
DHARAMPETH, M. P. DEO MEMORIAL &
SCIENCE COLLEGE, NAGPUR

Dr. Mrs. Shradha Deshpande
Teacher In-charge

Dr. Ajitkesh Purtoni
Principal
Dharampeth M.P. Deo Memorial
Science College, Nagpur



DHARAMPETH M. P. DEO MEMORIAL SCIENCE COLLEGE, NAGPUR
INTERNAL QUALITY ASSURANCE CELL (IQAC)

Activity Report

Date: 29/09/2022

Name of Organizing Department or Committee: Computer Science

Name of the activity: Power Point Presentation

Suggested CRITERION point if any: V

Date of Activity: 23/09/2022

Place of Activity: Computer Science Laboratory

Name of Guest Speaker/s or Judge/s or Chief Guest/s if any: NA

Title of the Activity: Power point presentation on application of Database Management System

Number of Participants: 19

Name of the Teacher In-charge / Convener: Mrs. Ruma Kapre

Names of other Committee Members / Staff: - NA

OUTCOME of the Activity with respect to mission vision of the institute and or academics:

To execute this activity student worked in groups to collect and compile the information on the given topic for the presentation. Then they placed their ideas in the PPT and on activity day they present their PPT very effectively. To present the given topic, they first studied the topic thoroughly then worked on which are the different areas who uses database system as their database which improves the knowledge on the given topic.

Activity with newspaper coverage if any: NA

Activity data save in PC of: Mrs. Ruma Kapre



Prof. Pitambar Humane
IQAC Coordinator

CO ORDINATOR

INTERNAL QUALITY ASSURANCE CELL
DHARAMPETH, M. P. DEO MEMORIAL &
SCIENCE COLLEGE, NAGPUR

Mrs. Ruma Kapre
Name & Signature of Teacher In-charge

Dr. Akhilesh Peshwe
Principal

Dharampeth M.P. Deo Memorial
Science College, Nagpur



DHARAMPETH M. P. DEO MEMORIAL SCIENCE COLLEGE,
North Ambazari Road, Near Ambazari Lake, Nagpur- 440033

DATA VALIDATION & VERIFICATION (DVV)

Name of the Programme : Power Point Presentation [SEM V%UNIT I]
Date of the Programme : 23/09/2022
Name of Chief Guest if any : _____
Name of Guest Speaker if any : _____

Sr. No.	Name of the Participant	Mobile Number	E-mail Id	Signature
1	Tanu Sanjay Mohurde	7057844882	tanumohurde45@gmail.com	T Mohurde
2	Khushi A. Gupta	9922997235	kg098920@gmail.com	K Gupta
3	Neha J. Bankar	8055477553	nehaz02bankar@gmail.com	N Bankar
4	Dikshita Sahaie	9028830809	wdikshitasahaie@gmail.com	Dikshita S.
5	Komal Kumbhare	7620314869	kumbharekomal94@gmail.com	Komal
6	Pranjal D. Sawadkar	7385458510	pranjald1sawadkar@gmail.com	Pranjal D.
7	Diya R. Patil	7757052463	diyapatil53@gmail.com	D Patil
8	Sahil R. Jivode	9373414643	sahiljivode73@gmail.com	Sahil R.
9	Seema M. Lakda	7058728070	seemalakda073@gmail.com	Seema M.
10	Pranay S. Dhore	8830629245	dhorepranay97@gmail.com	P Dhore

Signature of:

Programme In-charge

Mrs. Ruma Kapore

IQAC Coordinator

CO ORDINATOR
INTERNAL QUALITY ASSURANCE CELL
DHARAMPETH, M. P. DEO MEMORIAL &
SCIENCE COLLEGE, NAGPUR

Principal

Dharampeth M.P. Deo Memorial
Science College, Nagpur.



DHARAMPETH M. P. DEO MEMORIAL SCIENCE COLLEGE,
North Ambazari Road, Near Ambazari Lake, Nagpur- 440033

DATA VALIDATION & VERIFICATION (DVV)

11	Vishal V. Girhale	9673681472	vishal.girhale.27@gmail.com	<u>Vishal</u>
12	Sahil R. Jivtade	9373414643	sahiljivtade73@gmail.com	<u>Sahil</u>
13	Sanchit Joshi	9975706788	sanchitjoshi01@gmail.com	<u>Sanchit</u>
14	Akash Das	7972942799	akash.das@gmail.com	<u>Akash</u>
15	Khushi DAVE	9890009937	kd2581477@gmail.com	<u>Khushi</u>
16	Ruchita Bhoyar	9527832686	Ruchita.bhoysar@gmail.com	<u>Ruchita</u>
17	Tanmay Gadani	7262034396	tanmaygadani1@gmail.com	<u>Tanmay</u>
18	Abhishek Falke	7823835535	abhishekpinalke88@gmail.com	<u>Abhishek</u>
19	Samiksha Sabhane	9307133863	samiksha.sabhane@gmail.com	<u>Samiksha</u>

Signature of

Programme In-charge

IQAC Coordinator

CO ORDINATOR

INTERNAL QUALITY ASSURANCE CELL
DHARAMPETH, M. P. DEO MEMORIAL &
SCIENCE COLLEGE, NAGPUR

Principal

Dharampeth M. P. Deo Memorial
Science College, Nagpur.



DHARAMPETH M. P. DEO MEMORIAL SCIENCE COLLEGE, NAGPUR

INTERNAL QUALITY ASSURANCE CELL (IQAC)
Activity Report

Date: 23/09/2022

Name of Organizing Department or Committee: Department of Physics

Name of the activity: NEP based Demonstration Activity for B.Sc. Sem-V

Suggested CRITERION point if any: Restricted to RTMNU BSc physics syllabus.

Date of Activity: 23/09/2022

Place of Activity: Room no. 004

Name of Guest Speaker/s or Judge/s or Chief Guest/s if any: NA

Title of the Activity: Demonstration Analogical explanation of Pauli's exclusion principle

Activity with newspaper coverage if any: No

Number of Participants: BSc Sem-V Students - 23

Name of the Teacher In-charge / Convener: Mr. Nishant Zode

Names of other Committee Members / Staff: N.A.

OUTCOME of the Activity with respect to academics:

This demonstration provided an opportunity to BSc Sem-V students to learn the phenomenon analogical explanation of Pauli's exclusion principle. The Pauli Exclusion Principle states that in a single atom no two electrons will have an identical set or the same quantum numbers (n , l , m_l , and m_s). To put it in simple terms, there are two person of same name living in same city (principle quantum number n), same ward (l), same building (m_l) but different floor (m_s) can relate with actual situation for electron. This example help to understand student how the exact electron would be in energy state.

DVV: Enclosed.

Activity data save in PC of: LL Dr. P. W. Ambekar

Prof. Pitambar Humane
IQAC Coordinator

CO ORDINATOR
INTERNAL QUALITY ASSURANCE CELL
DHARAMPETH, M. P. DEO MEMORIAL &
SCIENCE COLLEGE, NAGPUR

Name & Signature of Teacher In-charge
DEPARTMENT OF PHYSICS
Dharampeth M. P. Deo Memorial
Science College, Nagpur

Dr. Akhilesh Peshwe
Principal

Principal
Dharampeth M.P. Deo Memorial
Science College, Nagpur.



DHARAMPETH M. P. DEO MEMORIAL SCIENCE COLLEGE NAGPUR

Department of Physics

Class: B.Sc. Sem.-V

NEP ACTIVITY

Paper-

I

Unit-

I

Name of the Teacher: Nishant Zode

Date: 23/09/2022

Title of Activity: Analogical Explanation of Pauli Exclusion Principle

Sr. No.	Name of Student	Batch	Mobile No.	Email ID	Signature
1	Rajni Nurkha Patthan	T-9	8669595748	Rajnikhan@gmail.com	R Patthan
2	Rani Dadanposed Pater	T-9	7888241794	Ranipatel5515@gmail.com	Rani.
3	Muskan Sheikh	T-9	8055474633	Muskan2019555@gmail.com	Muskan
4	Shivani Bhute	T-10	9302500209	Bhuleshivani83@gmail.com	Bhute
5	Snehal Bute	T-10	7058756570	snehalbute721@gmail.com	Snehal
6	Adesh Hatwar				
7	Sakshi MOON	T-10	7745827736		S Moon
8	Pallavi Pragat	T-10	9022654940	Pallavi2208@gmail.com	Pragat
9	Nikita Rahangdale	T-9	9307723308	Nikitarahangdale2005	Nikita
10	Divy Bondre	T-9	9552173633		Divy Bondre
11	Nikita Shebe	T-8	902108101		Nikita Shebe
12	Aachal Wagh	T-8	9599284325		
13	Ashwini Suryawarshi	T-9	8087317227	Suryawarshishwini103@gmail.com	Ashwini
14	Aarju Patle	T-9			
15	Aakash A. Silcda	T-10	9179222057	Silcdaakash15@gmail.com	Aakash
16	Chaitali M. Barchade	T-8	9359540394	Chaitali2006@gmail.com	Chaitali
17	Priyankhi Singh	T-8	7721925721		Priyankhi Singh
18	Akanksha Ryoluse	T-8	8767935524	Akanksharyoluse@gmail.com	Akanksha
19	Anshuman Sharma	T-8	9370592462	anshumanstam@gmail.com	Anshuman
20	Savabh Shukla	T-8	7721802706		Savabh
21	Deepak Khambhate	T-7			Deepak
22	Shivam Harwaja	T-8	9607823702	Shivamharwaja1201@gmail.com	Shivam
23	chetan Kamthe	T-7	9637271601	Kamthechetan@gmail.com	Chetan

N Zode

Signature of Teacher

W S

Head of Department

HEAD

DEPARTMENT OF PHYSICS
Dharampeth M. P. Deo Memorial
Science College, Nagpur



DHARAMPETH M. P. DEO MEMORIAL SCIENCE COLLEGE, NAGPUR
INTERNAL QUALITY ASSURANCE CELL (IQAC)

Activity Report Date: 30/09/2022

Name of Organizing Department or Committee: Home Science Department

Name of the activity: Visit to Furniture Shop

Suggested CRITERION point if any: Criteria II & V

Date of Activity: 24/09/2022

Place of Activity: Rani Jhansi Square, Sitabuldi, Nagpur

Name of Guest Speaker/s or Judge/s Resource Person if any: Mr. Sanjay Joshi.

Title of the Activity: Visit to Furniture Shop

Number of Participants: 16 students of Semester IIIrd

Name of the Teacher In-charge / Convener: Ms. Ankita Wankhede

Names of other Committee Members / Staff: Mrs. Manju Deshpande

OUTCOME of the Activity with respect to mission vision of the institute and or academics:

1. They learn about various material used for making different types of furniture and their care/ maintenance such as Chairs, study table, showcase, wardrobe, bed, sofa, sofa cum bed, dressing table, dining table etc.
2. Students learn how the furniture are made by waste material of wood and which type of furniture are generally used in home, school, college, and public places.
3. From this visit students learn many new things which are used in market and get knowledge about furniture.

Activity with newspaper coverage if any: _____

Activity data save in PC of: Home Science Staff Room Desktop

Note: Kindly share geotag photographs separately along with report on iqacdsc2022@gmail.com



Ankur

Prof. Pitambar Humane
CO ORDINATOR
IQAC Coordinator
INTERNAL QUALITY ASSURANCE CELL
DHARAMPETH, M. P. DEO MEMORIAL &
SCIENCE COLLEGE, NAGPUR

Name & Signature of Teacher In-charge

Ankita Wankhede

Manju Deshpande

Akhilesh Peshwe
Principal
PRINCIPAL

Dharampeth M. P. Deo Memorial
Science College, Nagpur-440033

DEPARTMENT OF HOME SCIENCE

NOTICE

All the Students are informed that arranged visit in Furniture Shop located at Rani Jhansi Square, Sitabuldi, Nagpur. Students of B.Sc Home Science Sem III come with your undertaking signed by your parents.

Time : 11:00am (Gather) *Assemble*

Venue : Home Science Department

N. Deshpande
Name of Teacher Incharge

N. Deshpande
Head of the Department



DHARAMPETH M. P. DEO MEMORIAL SCIENCE COLLEGE,
North Ambazari Road, Near Ambazari Lake, Nagpur- 440033

DATA VALIDATION & VERIFICATION (DVV)

Name of the Programme : Visit Exos Furniture Shop
Date of the Programme : 24/09/22
Name of Chief Guest if any : _____
Name of Guest Speaker if any : Ms. Sanjay Joshi

Sr. No.	Name of the Participant	Mobile Number	E-mail Id	Signature
1]	Mansi . N. Chaudhari	9720088783	chaudhaimansi921@gmail.com	
2]	Riya . u. Maity	7350980367	maityriya23@gmail.com	
3]	Bhagyshree Ambule	9359139068	ambuleb667@gmail.com	
4]	Purnali Chonghadkar	9309079427	Purnali29h@gmail.com	
5]	Kimaya N. Kale	8866073792	kimayakale06@gmail.com	
6]	Avani Shenwai	9096507459	avanshenwai5@gmail.com	
7]	Ajasi Wankhede	8707699751	wankhedeajasi@gmail.com	
8]	Tannu Kohde	7841984450	pradtonnu13@gmail.com	
9]	Pragya Tiwari	6394098386	Pragyatiwari14052002@gmail.com	
10]	Vaishnavi Proadhan	9763169560	proadhanvaishnavi16@gmail.com	

Signature of:

Programme In-charge

Ancita Wankhede

IQAC Coordinator

CO ORDINATOR

INTERNAL QUALITY ASSURANCE CELL
DHARAMPETH, M. P. DEO MEMORIAL &
SCIENCE COLLEGE, NAGPUR

Principal
PRINCIPAL

Dharampeth M. P. Deo Memorial
Science College, Nagpur-440033



DHARAMPETH M. P. DEO MEMORIAL SCIENCE COLLEGE,
North Ambazari Road, Near Ambazari Lake, Nagpur- 440033

DATA VALIDATION & VERIFICATION (DVV)

11)	Shrushti Patkar	738 706 7403	shrushtipatkar@gmail.com	<u>Patkar</u>
12)	Pallavi B. Katre	845327 7408	pkatre593@gmail.com	<u>Pallavi</u>
13)	Karishma P. Dine		Dine karishma@gmail	<u>Karishma</u>
14)	Sujata V. Kaware		kaware.sujata@gmail	<u>Sujata</u>
15)	Pritya Khawshi			<u>Pritya</u>
16)	Pranjakta Wakte			<u>Wakte</u>

Signature of

Programme In-charge

Ankita Wankhede

Wankhede

CO-ORDINATOR

INTERNAL QUALITY ASSURANCE CELL
DHARAMPETH, M. P. DEO MEMORIAL &
SCIENCE COLLEGE, NAGPUR

Principal

PRINCIPAL

Dharampeth M. P. Deo Memorial
Science College, Nagpur-440033



DHARAMPETH M. P. DEO MEMORIAL SCIENCE COLLEGE, NAGPUR
INTERNAL QUALITY ASSURANCE CELL (IQAC)

Activity Report

Date: 26/09/2022

Name of Organizing Department or Committee: Chemistry

Name of the activity: Chemical society Inauguration 2022-2023 followed by Guest lecturer

Suggested CRITERION point if any: I

Date of Activity: 24/09/2022

Place of Activity: Late Shri Vinayakrao Phatak Hall

Name of Guest Speaker/s or Judge/s or Chief Guest/s if any: Dr. Ratiram Chaudhary

Title of the Activity: Installation and Inauguration of Chemical Society 2022-2023

Number of Participants: 145

Name of the Teacher In-charge / Convener: Dr. Vaishali p. Meshram

Names of other Committee Members / Staff: Dr. Sandip Bhivgade, Ms. Niharika Sute , Dr. Mrudul Keskar, anushree Wele, Mayank

OUTCOME of the Activity with respect to mission vision of the institute and or academics:

Under the Chemical society "ALCHEMY" 2022-2023 various students from different Sem become a members of this society. President of chemical society planned different activities throughout the session like Seminar, Visits, and competitions. In the guest lecturer students were benefited and they awared about what are the scope of chemistry after passing B. Sc and opportunism in Chemistry .

Activity with newspaper coverage if any: ___

Activity data save in PC of: Chemistry

Note: Kindly share geotag photographs separately along with report on iqacdsc2022@gmail.com



Prof. Pitambar Humane
IQAC Coordinator

COORDINATOR
INTERNAL QUALITY ASSURANCE CELL
DHARAMPETH, M. P. DEO MEMORIAL &
SCIENCE COLLEGE, NAGPUR

Name & Signature of Teacher In-charge

Dr. Akhilesh Peshwe
Principal

PRINCIPAL
Dharampeth M.P. Deo Memorial
Science College, Nagpur-440033



DHARAMPETH M. P. DEO MEMORIAL SCIENCE COLLEGE,
North Ambazari Road, Near Ambazari Lake, Nagpur- 440033

DATA VALIDATION & VERIFICATION (DVV)

Name of the Programme : Chemical Society Inauguration
Date of the Programme : 24th sept 2022
Name of Chief Guest if any : Dr. Ratisam G. Chaudhary
Name of Guest Speaker if any : Dr. Ratisam G. Chaudhary

Sr. No.	Name of the Participant	Mobile Number	E-mail Id	Signature
01.	Abhay P. Tembhare	8975363145	abhay230101@gmail.com	
2.	Nitu B. Raj	7058638984	nituh1419@gmail.com	
3.	Nisha V. Pandey	8605231390	abhishela_garde_8605231390@gmail.com @Nishy	
4.	Kalyani R. Sindrham	8446539622	Sindrhamkalyani@gmail.com @Sindrham	
5.	Aparna Mahare	7020649887	aparnamahare250@gmail.com	
6.	Arya Dhoke	9011681628	aryadhoke@gmail.com	
7.	Priyanshu Raut	9322725233	priyanshuraute56@gmail.com	
8.	Yogita Denge	7058437260	yogitadenge@gmail.com	
9.	Ravindra Khadse	8004198273	khadseravindra9842@gmail.com	
10.	Arpita Kusum	9146162921	arpitakusum@gmail.com	

Signature of:

Programme In-charge

IQAC CO-ORDINATOR
INTERNAL QUALITY ASSURANCE CELL
DHARAMPETH, M. P. DEO MEMORIAL &
SCIENCE COLLEGE, NAGPUR

Principal
PRINCIPAL
Dharampeth M.P. Deo Memorial
Science College, Nagpur-440033



DHARAMPETH M. P. DEO MEMORIAL SCIENCE COLLEGE,
North Ambazari Road, Near Ambazari Lake, Nagpur- 440033

DATA VALIDATION & VERIFICATION (DVV)

Name of the Programme : Chemical Society Inauguration
Date of the Programme : 24th sept 2022
Name of Chief Guest if any : Dr. Ratisam G. Chaudhary
Name of Guest Speaker if any : Dr. Ratisam G. Chaudhary

Sr. No.	Name of the Participant	Mobile Number	E-mail Id	Signature
11	Vaishnavi Tonge	8421657925	Vaishnavitonge2004@gmail.com	
12	Komalika chandhari	9322033866	Komalikachandhari073@gmail.com	
13	Aasiya S. Hussain Adl	7066411418	hussainasiya094	
14	Ghanashree U. Dhomane	7774900320	ghomaneghanashree@gmail.com	
15	Aarti. Kharole	9579745628	aartikharole@gmail.com	

Signature of:

Programme In-charge

CO-ORDINATOR
INTERNAL QUALITY ASSURANCE CELL
DHARAMPETH, M. P. DEO MEMORIAL &
SCIENCE COLLEGE, NAGPUR

Principal
PRINCIPAL
Dharampeth M.P. Deo Memorial
Science College, Nagpur-440033



DHARAMPETH M. P. DEO MEMORIAL SCIENCE COLLEGE,
North Ambazari Road, Near Ambazari Lake, Nagpur- 440033

DATA VALIDATION & VERIFICATION (DVV)

1	Aryal. R. Thakre	7066554821	thakrearyal381@gmail.com Aryal
2	Apeksha D. Katangale	7559455793	apekshakatangale26@gmail.com Apeksha
3	Aakanksha. K. Khabrapade	7972228707	aakankshakhabrapade@gmail.com Aakanksha
4	Vaishnavi N. Tunje	8421657943	Vaishnavitunje2004@gmail.com Vaishnavi
5	Aarushi S. Hussein	7066411418	huseeinarushiyugau01 Hussein
6	Lucky A Vishwakarma	9579660186	lvishwakarma290@gmail.com Vishwakarma
7	Gunjan J. Bhoyar	7666799586	gunjanbhoyar004@gmail.com Gunjan
8	Ashwini. A. Lanjewar	9689117254	lanjewarashwini777@gmail.com Ashwini
9			

Signature of:

Programme In-charge



IQAC Coordinator

PRINCIPAL

Dharampeth M.P. Deo Memorial
Science College, Nagpur-440033



DHARAMPETH M. P. DEO MEMORIAL SCIENCE COLLEGE,
North Ambazari Road, Near Ambazari Lake, Nagpur- 440033

DATA VALIDATION & VERIFICATION (DVV)

Name of the Programme : Guest Lecture
Date of the Programme : 24th Sept, 2022
Name of Chief Guest if any : Dr. Ratiram Chaudhary
Name of Guest Speaker if any : Dr. Ratiram Chaudhary

Sr. No.	Name of the Participant	Mobile Number	E-mail Id	Signature
1	Shruti M. Pawar	9527988707	shruti.pawar.0001@gmail.com	
2	Ishika S. Thakre	8010907069	ishithakre27@gmail.com	
3	Tisha D. Kature	9021540548	tishakature@gmail.com	
4	Laxmi M. Gunde	7758058514	laxmiguinde2308@gmail.com	
5	Bhargavi A. Sambare	7709403806	bhargavisambare05@gmail.com	
6	Achit K. Dhole	8847109571	achitdhole9@gmail.com	
7	Tanushree R. Date	9766927406	tanushree02@gmail.com	
8	Shital D. Patle	9764596337	sp@gmail.com	
9	Nandini P. Pounikar	9764359642	nandnipounikar@gmail.com	
10	Suhani P. Inclurkar	9370419064	suhaniinclurkarg90@gmail.com	

Signature of:

Programme In-charge

IQAC Coordinator

CO ORDINATOR
INTERNAL QUALITY ASSURANCE CELL
DHARAMPETH, M. P. DEO MEMORIAL &
SCIENCE COLLEGE, NAGPUR

Principal

PRINCIPAL
Dharampeth M.P. Deo Memorial
Science College, Nagpur-440033



DHARAMPETH M. P. DEO MEMORIAL SCIENCE COLLEGE,
North Ambazari Road, Near Ambazari Lake, Nagpur- 440033

DATA VALIDATION & VERIFICATION (DVV)

Name of the Programme : Chemical Society Alchemy-2022-23 Inauguration
Date of the Programme : 24th sept 2022
Name of Chief Guest if any : Dr. Rati Ram G. Chaudhary
Name of Guest Speaker if any : Dr. Rati Ram G. Chaudhary

Sr. No.	Name of the Participant	Mobile Number	E-mail Id	Signature
11.	Vaidehi B. Kodmatwar	8788245910	vaidehikodmatwar@gmail.com	
12.	Pranjali N. Gaikwad	9130893362	gaikwadpranjali39@gmail.com	
13.	Rashani M. Bambal	9325853408	rashani2018bb@gmail.com	
14)	Nandini S. Hodge	9370301679	nandinihodge17@gmail.com	
15)	Aashi B. Bisen	8767549078	aashibisen129@gmail.com	
16)	Pranali Y. Chawhane	9699654562	pranali.chawhane69@gmail.com	
17)	Shivam Patel	7038889083	Shivam03@gmail.com	
18)	Pratiksha M. Meshram	8459070938	meshrampratiksha11-6	
19)	Monika H. Patel	9499225468	Monika97834@gmail.com	
20)	Saurabh Chaudhary	9359883501	schaudhary5599@gmail.com	

Signature of:

Programme In-charge

COORDINATOR
INTERNAL QUALITY ASSURANCE CELL
DHARAMPETH, M. P. DEO MEMORIAL &
SCIENCE COLLEGE, NAGPUR

PRINCIPAL
Dharampeth M.P. Deo Memorial
Science College, Nagpur-440033



DHARAMPETH M. P. DEO MEMORIAL SCIENCE COLLEGE,
North Ambazari Road, Near Ambazari Lake, Nagpur- 440033

DATA VALIDATION & VERIFICATION (DVV)

21	Ankit R. Patel	9970905638	ankitpatel797275@gmail.com	
22	Krushnali S. Kadu	8625854995	krushnalikaduf@gmail.com	
23	Shiwari S.R. Dwivedi	8855900546	shiwari.dwivedi4@gmail.com	
24	Bhumika D. Chedge	8830391103	Bhumikachedge@gmail.com	
25	Nikita J. Kalle	8468847327	kalle.nikita54@gmail.com	
26	Shrutika R. Borkar	9017950845	shrutika4@gmail.com	
27	Shital R. Kelzakar	9173385046	shital2020kk@gmail.com	
28	Sejal R. Lakhurpal	9028851568	sejallakurpal@gmail.com	
29	Ritik M. Varma	9356744234	ritik1929@gmail.com	
30	Anjali Meshram	7767905772	anjali.meshram2022@gmail.com	
31	Pooja Bisen	8483097439	Poojabisen254@gmail.com	
32	Rinam C Wankhede	8010966529	wankhedexinam07@gmail.com	

Signature of:

Programme In-charge

CO ORDINATOR
INTERNAL QUALITY ASSURANCE CELL
DHARAMPETH, M. P. DEO MEMORIAL &
SCIENCE COLLEGE, NAGPUR

PRINCIPAL
Dharampeth M.P. Deo Memorial
Science College, Nagpur-440033



DHARAMPETH M. P. DEO MEMORIAL SCIENCE COLLEGE,
North Ambazari Road, Near Ambazari Lake, Nagpur- 440033

DATA VALIDATION & VERIFICATION (DVV)

Srno.	Name	Mobile no.	E-mail	Sign
1.	Priyanshi Singh	7219259020	priyanshisingh180406@gmail.com	P Singh
2.	Raksha Dhote	7498511875	rakshadhote3@gmail.com	Raksha
3.	Chaitali Buzbade	9359540394	chaitali2020b@gmail.com	Chaitali
4.	Akanksha Yelure	8767935524	akankshayelure@gmail.com	Akanksha
5.	Pragya Jha	9665852875	pragya1297@gmail.com	Pragya
6.	Anushka Das	7058933157	ad04092001@gmail.com	Anushka
7.	Pallavi Bhagat	9022654940	Pallavi2208@gmail.com	P Bhagat
8.	Aditi K. Dhoble	8847709571	aditidhoble4@gmail.com	Aditi Dhoble
9.	Shivam S. Maurya	9607373702	ShivamMaurya2001@gmail.com	Shivam
10.	Tanmay Bhute	7697250831	tanmaybhute900@gmail.com	Tanmay
11.	Anushka S. Wele	8530778433	anushkawele2001@gmail.com	Anushka Wele
12.	Bhargavi, Sambhare	7709403806	Bhargavisambhare@gmail.com	Bhargavi
13.	Nandini. Hadge	9370301699	Nandinihadge17@gmail.com	N Hadge
14.	Laxmi. Gorle	7758058514	laxmigorle@gmail.com	Laxmi Gorle

Signature of

Programme In-charge

CO-ORDINATOR
INTERNAL QUALITY ASSURANCE CELL
DHARAMPETH, M. P. DEO MEMORIAL &
SCIENCE COLLEGE, NAGPUR

Principal
PRINCIPAL
Dharampeth M. P. Deo Memorial
Science College, Nagpur-440033



DHARAMPETH M. P. DEO MEMORIAL SCIENCE COLLEGE,
North Ambazari Road, Near Ambazari Lake, Nagpur-440033

DATA VALIDATION & VERIFICATION (DVV)

15.	Ishika . Thakre	8010307069		
16.	Shruti . Pawar	9527988707	shruti.pawar000@gmail.com	
17.	Anjali . Pali	7498102109	anjanjali446@gmail.com	
18.	Tammar . Chaudhasei	8600102341	tchaudhasei7600@gmail.com	
19.	Manish . Gade	9370329857	manishgade75@gmail.com	
20.	Tejas Solanki	7080780670	tejas.solanki@gmail.com	
21.	Kaushik Adarkhija	8550597159	kaushik0@gmail.com	
22.	Sakshi Gisei	9529660277	sakshigisei2002@gmail.com	
23.	Pooch varabhe	9325336932		
24.	Akanksh Bhute	93569641291		
25.	Dally Gabhane	9284269236		
26.	Anjali N. Charde	8261964188	anjali.charde20@gmail.com	
27.	Aadesh . hadwar	7517431162		
28.	Tesha Kature	9021541048	tesha@gmail.com	

Signature of:

Programme In-charge

CO ORDINATOR
INTERNAL QUALITY ASSURANCE CELL
DHARAMPETH, M. P. DEO MEMORIAL &
SCIENCE COLLEGE, NAGPUR

Principal
PRINCIPAL

Dharampeth M.P. Deo Memorial
Science College, Nagpur-440033



DHARAMPETH M. P. DEO MEMORIAL SCIENCE COLLEGE,
North Ambazari Road, Near Ambazari Lake, Nagpur- 440033

DATA VALIDATION & VERIFICATION (DVV)

Name of the Programme : Chemical Society Alchemy 2022-23 Inauguration
Date of the Programme : 24th Sept. 2022
Name of Chief Guest if any : Dr. Ratiram G. Chaudhary
Name of Guest Speaker if any : Dr. Ratiram G. Chaudhary

Sr. No.	Name of the Participant	Mobile Number	E-mail Id	Signature
1.	Ritika Ravindra Bhojar	9834587087	ritikabhoyar28@gmail.com	
2.	Shivam Manuja	9607873702	shivammaujal2911@gmail.com	
3.	Tanmay Bhute	7697250831	tanmaybhute900@gmail.com	
4.	Vishal Karnan Singh	9610187223	Singhvishal9602@gmail.com	
5.	Chetan Kamthe	9637271601	kamthechetan6@gmail.com	
6.	Saurabh Shukla	7721802706	ShuSaurabh77@gmail.com	
7.	Sujay Shende	9356666487	sujayshende2018@gmail.com	
8.	Nitin Hasinkhede	9561173324	hasinkhede.vijay@gmail.com	
9.	Amit J. Walde	9168496253	amitwalde440divya@gmail.com	
10.	Mukesh Oraon	7249339368	Oraonm64@gmail.com	

Signature of:

Programme In-charge

IQAC Coordinator
CO ORDINATOR
INTERNAL QUALITY ASSURANCE CELL
DHARAMPETH, M. P. DEO MEMORIAL &
SCIENCE COLLEGE, NAGPUR

Principal
PRINCIPAL
Dharampeth M.P. Deo Memorial
Science College, Nagpur-440033



DHARAMPETH M. P. DEO MEMORIAL SCIENCE COLLEGE,
North Ambazari Road, Near Ambazari Lake, Nagpur- 440033

DATA VALIDATION & VERIFICATION (DVV)

Name of the Programme : Chemical Society Alchemy 2022-23 Inauguration
Date of the Programme : 24th sept. 2022
Name of Chief Guest if any : Dr. Ratiram G. Chaudhary
Name of Guest Speaker if any : Dr. Ratiram G. Chaudhary

Sr. No.	Name of the Participant	Mobile Number	E-mail Id	Signature
11	Jasraj D. Paliwal	9370820325	jasrajpaliwal47@gmail.com	Jasraj
12	Khushi Aundhkar	8767279513	khushiandhkar652@gmail.com	Khushi
13	Prachi S. Waghale	8767914118	Prachiwaghale11@gmail.com	Prachi
14	Sulphiya Patle	7757871925	PatleSulphiya12@gmail.com	Patle
15	Damini M. Bhandbuche	8275105785	bhandbucheDamini@gmail.com	D. Bhandbuche
16	Raksha D. Dhote	7498511875	rakshadhote3@gmail.com	Raksha
17	Chaitali M. Burebade	9399540394	chaitali20206@gmail.com	Chaitali
18	Pragya R. Jha	8665852875	pragyaj687@gmail.com	Pragya
19	Anushka S. Das	7058933157	ad04092001@gmail.com	Anushka
20	Priyanshi Singh	7219259020	priyanshisingh1804@gmail.com	Singh

Signature of:

Programme In-charge

COORDINATOR
INTERNAL QUALITY ASSURANCE CELL
DHARAMPETH, M. P. DEO MEMORIAL &
SCIENCE COLLEGE, NAGPUR

PRINCIPAL
Dharampeth M.P. Deo Memorial
Science College, Nagpur-440033



DHARAMPETH M. P. DEO MEMORIAL SCIENCE COLLEGE,
North Ambazari Road, Near Ambazari Lake, Nagpur- 440033

DATA VALIDATION & VERIFICATION (DVV)

21	Akanksha R. Yeluge	8767835524	akankshayeluge@maic.com	Akanksha
22	Rani D. Patel	7888241794	ranipatel5515@gmail.com	Rani
23	Roji N. Pathan	8669595198	rojikhane6024@gmail.com	R. Pathan
24	chetan D. Bhopre	9021055104	Bhoprechetan@gmail.com	Chetans
25	Ashita G. Dewkar	9088915776	dewkarashita17@gmail.com	Ashita
26	Prachi K. Varabhe	9325336932	Prachivarabhe@gmail.com	Prachi
27	Neha L. Wanjari	9378882266	nehawanjar733@gmail.com	Neha
28	Dolly B. Gabhane	9284269236	dollygabhane7@gmail.com	B. Gabhane
29	Sakshi S. Gite	9529660277	sakshigite204@gmail.com	Sakshi
30	Akansha S. Bhute	9356964121	akansha22206@gmail.com	A. Bhute
31	Arpita Gaydhane	9527250282	arpitagaydhane@gmail.com	Arpita
32	Ayushi Shukla	9373668043	ayushishukla812002@ chudhaisamritaha	Ayushi
33	Samiksha Choudhary	7517090406	26@gmail.com	S. Choudhary
34	Madhura Bhondure	8767484914	madhurbhondure@kri	Madhura
35	Jamisha Kundekar	9145253158	samikshakundekar@gmail.com	Jamisha

Signature of:

Programme In-charge

COORDINATOR
INTERNAL QUALITY ASSURANCE CELL
DHARAMPETH, M. P. DEO MEMORIAL &
SCIENCE COLLEGE, NAGPUR

PRINCIPAL
Dharampeth M.P. Deo Memorial
Science College, Nagpur-440033



DHARAMPETH M. P. DEO MEMORIAL SCIENCE COLLEGE,
North Ambazari Road, Near Ambazari Lake, Nagpur- 440033

DATA VALIDATION & VERIFICATION (DVV)

36.	Suman. Ashutosh. Singh	7249465307	missumansingh3@gmail.	<u>Suman</u>
37	Muskam V. Kulkarni	9156889239	Muskamkulkarni34@gmail.com	<u>SW</u>
38)	Ritika R. Sondliya	9175581655	ritikasondliya@gmail.com	<u>Ritika</u>
39)	Umang G. Wauthi	9322428500	Umangwauthi@gmail.com	<u>Umang</u>
40)	Aditi B. Tiwari	8087143696	adititiwari0721@gmail.com	<u>Aditi</u>
41)	Aditi Kaloo	9623739760	aditikaloo20012008@gmail	<u>Aditi</u>
42)	Supriya Talang	9970896798	supriyatalang01@gmail.com	<u>Supriya</u>
43)	Gayatri Funder	8669311098	gayatrifunder1@gmail.com	<u>Gayatri</u>
44)	Diksha Tamgadga	7798062845	dikshatamgadga21624@gmail.com	<u>Diksha</u>
45)	Minakshi Rahangdale	9459183647	minakshirahangdale@gmail.com	<u>Minakshi Rahangdale</u>
46)	Tanmay Choudhary	8600102341	tchoudhary8600@gmail.com	<u>Tanmay</u>
47)	Hitesh Hulke	8624091652	hulkonit0807002@gmail.com	<u>Hitesh</u>
48)	Harshad warthi	7414993575	harshadwarthi972@gmail.com	<u>Harshad</u>
49)	Sahil Singh	7259968502	sahilsingh@gmail	<u>Sahil</u>
50)	Aadash D. Chandel	9325184628	imaadashchandel@gmail.com	<u>Aadash</u>

Signature of:

Programme In-charge

COORDINATOR
INTERNAL QUALITY ASSURANCE CELL
DHARAMPETH, M. P. DEO MEMORIAL &
SCIENCE COLLEGE, NAGPUR

PRINCIPAL

Dharampeth M.P. Deo Memorial
Science College, Nagpur-440033



DHARAMPETH M. P. DEO MEMORIAL SCIENCE COLLEGE,
North Ambazari Road, Near Ambazari Lake, Nagpur- 440033

DATA VALIDATION & VERIFICATION (DVV)

51	Anchal D. Yadav	8605598634	anchalyadav143@gmail.com
52	Yash S. Chamat	7038488758	yashchamat32@gmail.com
53	Pratik Bhartiya	9665466779	
54	Sayali Pandhalipande	8208121810	Sayali0454@gmail.com
55	Harish Kodappe	9604677672	harishkodappe8@gmail.com

Signature of:

Programme In-charge

COORDINATOR
INTERNAL QUALITY ASSURANCE CELL
DHARAMPETH, M. P. DEO MEMORIAL &
SCIENCE COLLEGE, NAGPUR

PRINCIPAL
Dharampeth M.P. Deo Memorial
Science College, Nagpur-440033



DHARAMPETH M. P. DEO MEMORIAL SCIENCE COLLEGE,
North Ambazari Road, Near Ambazari Lake, Nagpur- 440033

DATA VALIDATION & VERIFICATION (DVV)

1)	Vijaya P. yele	8668731172	vijayakatse12345@gmail.com	yele
2)	Yash. S. Chamat	7038468758	Yashchamat123@gmail.com	Chamat

Signature of: 
Programme In-charge

COORDINATOR
INTERNAL QUALITY ASSURANCE CELL
DHARAMPETH, M. P. DEO MEMORIAL &
SCIENCE COLLEGE, NAGPUR

Principal
PRINCIPAL
Dharampeth M.P. Deo Memorial
Science College, Nagpur-440033



DHARAMPETH M. P. DEO MEMORIAL SCIENCE COLLEGE,
North Ambazari Road, Near Ambazari Lake, Nagpur- 440033

DATA VALIDATION & VERIFICATION (DVV)

Name of the Programme : Chemical society Alchemy-2022-23 Inauguration
Date of the Programme : 24th sept. 2022
Name of Chief Guest if any : Dr. Ratisam G. Chaudhary
Name of Guest Speaker if any : Dr. Ratisam G. Chaudhary

Sr. No.	Name of the Participant	Mobile Number	E-mail Id	Signature
01	Aditi U. Kaloo	9623739760	aditikaloo200120sc@gmail.com	
02	Manju. A. Prajapati	7758002551	Prajapatimanju40@gmail.com	
03	Gayatri G. Fender	8669311098	gayatrifender@gmail.com	
04	Supriya telang	9970896798	Supriyatelang0@gmail.com	
05	Shital R. Halkar	9767599434	Shitalh582@gmail.com	
06	Minakshi R. Rahangdale	8459183647	minakshirahangdale1995@gmail.com	
07	Pallavi M. patte	9673986807	Pallavipatte2905@gmail.com	
08	Akanksha .V. Badade	9145226326	akankshabadade@303mail.com	
09	Prachi .K. Molghare	9373526876	prachimolghare2020@gmail.com	
10	Diksha K. Tamogadpe	7798062845	Dikshatamogadpe2162@gmail.com	

Signature of

Programmatic In-charge

COORDINATOR
IOAC Coordinator
INTERNAL QUALITY ASSURANCE CELL
DHARAMPETH, M. P. DEO MEMORIAL &
SCIENCE COLLEGE, NAGPUR

PRINCIPAL
Dharampeth M. P. Deo Memorial
Science College, Nagpur-440033



DHARAMPETH M. P. DEO MEMORIAL SCIENCE COLLEGE, NAGPUR
INTERNAL QUALITY ASSURANCE CELL (IQAC)

Activity Report

Date: 24th September 2022

Name of Organizing Department or Committee: Electronics Department
Name of the Activity : Poster making of 'Block Diagram of 8085' (NEP)
Suggested CRITERION point if any: Suggested criteria II
Date of Activity: 24th September 2022
Place of Activity : Electronics Lab

Name of Guest Speaker/s or Judge/s or Chief Guest/s if any : Not applicable

Title of the Activity: Poster making of 'Block Diagram of 8085'
Based on Unit : 1(Paper II)
Class : Semester V
Number of Participants: 20

Name of the Teacher In-charge / Convener: Prof. V. V. Rangari

OUTCOME of the Activity with respect to mission vision of the institute and or academics:

Students learn about the architecture of 8085 Microprocessor. Each block was explained to the students in detail so that they can understand how the 8085 microprocessor works.

Prof. Varsha V. Rangari

Head of the Department



Prof. Pitambar Humane

IQAC Coordinator

CO ORDINATOR

**INTERNAL QUALITY ASSURANCE CELL
DHARAMPETH, M. P. DEO MEMORIAL &
SCIENCE COLLEGE, NAGPUR**



Dr. Akhilesh Peshwe

Principal
**Dharampeth M.P. Deo Memorial
Science College, Nagpur.**



Dharampeth M. P. Deo Memorial Science College,
Nagpur

Electronics Department
Semester V - (2022-23)

Activity 1
Based on Paper II -Unit 1

Date: 24/09/2022

Activity: Poster making of "Block Diagram of 8085".

Sr. No.	Students Name	Signature
1.	NSKHIZ Ijankar	
2.	Pratham Sonar	
3]	Mukund Hood	
4]	Rajat Rohad	
5]	Bhavesh Maske	
6]	Mahesh Maske	
7]	Sagar Sonwane	
8]	Umesh Jadhav	
9]	Aniket Sonwane	
10]	Aarti Singh	
11]	Kiran Waghade	
12]	Sakshi Huddar	
13]	Sakshi Hiwarkar	
14]	Soniya Chariya	
15]	Tanmay S. Gadgil	
16]	Pranav S. Mahajan	
17]	Prakash M. Khanal	
18]	Saurabh P. Sharma	
19]	Rani D. Kotate	

20] ABHIJEEET MANKAR

~~20]~~



DHARAMPETH M. P. DEO MEMORIAL SCIENCE COLLEGE, NAGPUR

Department of Electronics

Semester V- (2022-23)

ACTIVITY (Paper II - Unit- 1)

Sr. No.	Student Name	Mobile Number	Email ID
1	Nikhil Kiran Jankar	8530960407	nikhiljankar@gmail.com
2	Pratham Manbahadur Sonar	7558464862	manbhaisonar@gmail.com
3	Mukund Sanjay Hood	9604785822	mukundahood2003@gmail.com
4	Rajat Laxman Rohad	9175635273	
5	Bhavesh Rameshwar Maske	7489951631	bhaveshmaske2002@gmail.com
6	Mahesh Prabhakarrao Maske	9021951173	maheshmaske48@gmail.com
7	Sagar Omprakash Sonwane	9356591564	sagarsonwane706@gmail.com
8	Samiksha Vasant Tabhane	9307133863	samikshavtabhane@gmail.com
9	Ankita Laxman Sonwane	9284801790	ankitasonwane10@gmail.com
10	Aarti Brijkishor Singh	7709208740	aartibsingh222@gmail.com
11	Kiran Ramesh Waghade	9860218676	rameshwaghade20@gmail.com
12	Sakshi Sanjay Huddar	9405142450	huddarmahi@gmail.com
13	Sakshi Satish Hiwarkar	9356651344	Sakshihiwarkar1831@gmail.com
14	Soniya Bhishamber Chaniya	7028563411	rvchaniya@gmail.com
15	Tanmay Sunil Gadam	7262034396	tanmaygadaml@gmail.com
16	Pranav Santosh Mahajan	9158377419	pranaymahajan413@gmail.com
17	Prakash Madhurvilas Khanal	7796875388	Khanalprakash151@gmail.com
18	Saurabh Pratap Sharma	9130964601	saurabh44002@gmail.com
19	Rani Devidas Kokate	7998945148	ranikokate1009@gmail.com
20	Abhijeet Shrikant Mankar	8309664405	abhijeetmankar5@gmail.com

Name & Signature of Teacher In-Charge

Prof. Pitambar Humane
IQAC Coordinator

CO ORDINATOR

INTERNAL QUALITY ASSURANCE CELL
DHARAMPETH, M. P. DEO MEMORIAL &
SCIENCE COLLEGE, NAGPUR

Name & Signature of Head of the Department

Dr. Akhilesh Peshwe
Principal

Principal

Dharampeth M.P. Deo Memorial
Science College, Nagpur.



DHARAMPETH M. P. DEO MEMORIAL SCIENCE COLLEGE, NAGPUR

INTERNAL QUALITY ASSURANCE CELL (IQAC)

Activity Report

Date: 24th September 2022

Name of Organizing Department or Committee: Electronics Department

Name of the Activity : Solving worksheet on Number systems(NEP)

Suggested CRITERION point if any: Suggested criteria II

Date of Activity: 24th September 2022

Place of Activity : Electronics Lab

Name of Guest Speaker/s or Judge/s or Chief Guest/s if any : Not applicable

Title of the Activity: Solving worksheet on Number systems

Based on Unit : I(Paper II)

Class : Semester I

Number of Participants: 19

Name of the Teacher In-charge / Convener: Mrs. Leena P. Thakare

OUTCOME of the Activity with respect to mission vision of the institute and or academics:

Students learn different number systems in digital electronics. They are aware about how to convert the given number into different number systems.

Prof. Varsita V. Rangari

Head of the Department



Prof. Pitambar Humane

IQAC Coordinator

CO ORDINATOR

**INTERNAL QUALITY ASSURANCE CELL
DHARAMPETH, M. P. DEO MEMORIAL &
SCIENCE COLLEGE, NAGPUR**



Dr. Akhilesh Peshwe

Principal

**Dharampeth M.P. Deo Memorial
Science College, Nagpur.**



Dharampeth M. P. Deo Memorial Science College,
Nagpur

Electronics Department
Semester I - (2022-23)

Activity 3

Based on Paper II -Unit 1

Date: 24/09/2022

Activity: Solving worksheet on Number Systems.

Sr. No.	Students Name	Signature
1.	Isha Waghmare	<u>Isha</u>
2.	Ved. S. Choudhary	<u>Ved.</u>
3.	Vedant O. Umekar	<u>Ved</u>
4.	Harshata Garkhede	<u>Harshata</u>
5.	Tejas Dongre	<u>Tejas</u>
6.	Tushal Achare	<u>Tushal</u>
7.	Vaidhree B. Gargal	<u>Vaidhree</u>
8.	TANU .A. SINGH	<u>Tanu</u>
9.	Simran Dhimale	<u>Dhimale</u>
10.	Abhishek Singh	<u>Singh</u>
11.	Khushbu Pali	<u>Khushbu</u>
12.	Jannu Varthia	<u>Varthia</u>
13.	Khushi Pali	<u>Khushi</u>
14.	Yogitee J. Kadamore	<u>Kadamore</u>
15.	Karish Bisen	<u>K. Bisen</u>
16.	Uday C. Baghete	<u>Uday</u>
17.	Bhagyashali D. Deware	<u>B. Deware</u>
18.	Deepak Karmare	<u>Deepak Karmare</u>
19.	Vineet M. Singh	<u>Vineet</u>



DHARAMPETH M. P. DEO MEMORIAL SCIENCE COLLEGE, NAGPUR

Department of Electronics

Semester I- (2022-23)

Activity (Paper II - Unit- 1)

Sr. No.	Student Name	Mobile Number	Email ID
1	Isha Ishwar Waghmare	8855919474	ishawaghmare9474@gmail.com
2	Ved Sudhir Choudhary	7498572766	vedchoudhary.cs.749@gmail.com
3	Vedant Onkar Umretkar	9049932753	umretkarvedant@gmail.com
4	Harshata Gunderao Warkhede	9860432428	bandukeshao20@gmail.com
5	Tejas Ramesh Dongre	9322578918	tejasdongre453@gmail.com
6	Tushal Rupkumar Achare	9075995617	acharetushal5@gmail.com
7	Vaidhavi Baburao Gongal	7507907278	gayatrigongal787@gmail.com
8	Tanu Ajay Singh	8806355808	tanusingh63492@gmail.com
9	Simran Narendra Dhimole	8390347026	mishralaxmi210@gmail.com
10	Abhishek Ravindra Singh	8208948107	abhi0882005@gmail.com
11	Khushbu Rajiv Pali	8459565214	palikhushbu59@gmail.com
12	Tannu Arun Varthi	9322044903	tannuvarthi@gmail.com
13	Khushi Rajiv Pali	8767607224	palikhushi4@gmail.com
14	Yogita Jaysing Karemore	8381045307	swara.karemore25@gmail.com
15	Kashish Kamalkumar Bisen	7887886117	kashishbisen05@gmail.com
16	Uday Chandrashekhar Baghele	8459549609	bagheleuday@gmail.com
17	Bhagyashali Dadarao Neware	7796434177	sakshineware2017@gmail.com
18	Deepak Surendra Kumar Kumar	7061735473	gauravasharma2@gmail.com
19	Vineet Mukesh Singh	9766035354	vineetsingh3533@gmail.com

Name & Signature of Teacher In-Charge

Prof. Pitambar Humane
IQAC Coordinator

CO ORDINATOR
INTERNAL QUALITY ASSURANCE CELL
DHARAMPETH, M. P. DEO MEMORIAL &
SCIENCE COLLEGE, NAGPUR

Name & Signature of Head of the Department

Dr. Varsha V. Rangari
Professor & Head
Department of Electronics
Dharampeth M.P. Deo Memorial

Science College, Nagpur

Dr. Akhilesh Peshwe
Principal
Dharampeth M.P. Deo Memorial
Science College, Nagpur.



DHARAMPETH M. P. DEO MEMORIAL SCIENCE COLLEGE, NAGPUR

INTERNAL QUALITY ASSURANCE CELL (IQAC)
Activity Report

Date: 26/09/2022

Name of Organizing Department or Committee: Department of Statistics

Name of the activity: Activity on Estimation of average height

Suggested CRITERION point if any: Restricted to RTMNU BSc Statistics syllabus.

Date of Activity: 26/09/2022

Place of Activity: Statistics Lab

Name of Guest Speaker/s or Judge/s or Chief Guest/s if any: NA

Title of the Activity: Estimation of average height of students (Girls and Boys)

Activity with newspaper coverage if any: No

Number of Participants: 20

Name of the Teacher: Ms. Kumudini Kadbe

Names of other Committee Members / Staff: N.A.

OUTCOME of the Activity with respect to academics:

Using this activity students will also be able to estimate the height of a few objects that they can measure (small tree, sign post, fence) to see how close their estimation is to the actual height.

DVV: Enclosed.

Activity data save in PC of: LL. Dr. P. W. Ambekar

Prof. Pitambar Humane
IQAC Coordinator

CO ORDINATOR
INTERNAL QUALITY ASSURANCE CELL
DHARAMPETH, M. P. DEO MEMORIAL &
SCIENCE COLLEGE, NAGPUR

Name & Signature of Teacher In-charge

Dr. Akhilesh Peshwe
Principal

Principal
Dharampeth M.P. Deo Memorial
Science College, Nagpur.



DHARAMPETH M. P. DEO MEMORIAL SCIENCE COLLEGE NAGPUR

Department of Statistics

Class: B.Sc. Sem.-V

NEP ACTIVITY

Paper- II

Unit- I

Name of the Teacher: Kumudini Kadbe

Date: 26/09/22

Title of Activity: Estimation of average height of students

Sr. No.	Name of Student	Batch	Mobile No.	Email ID	Signature
1	Prachi S. Manu Smarve	PSM (TH)	9336969609	prachimanusmarve@gmail.com	<u>Prachi Smarve</u>
2	Himanshu R. Lakhe	PSM	7648252469	himanshulakhe08@gmail.com	<u>Lakhe</u>
3	Piyush G. Kapse	PSM	9373563023	Kapsepiyush02@gmail.com	<u>Piyush</u>
4	Pratiksha S. Thakre	PSM	8459520299	Pratikshathakre199@gmail.com	<u>Thakre</u>
5	Divyani U. Dhule	PSM	7030731921	divyandhule2002@gmail.com	<u>Divyani Dhule</u>
6	Uday P. Khandarkar	PSM	9545897196	udaykhandarkar98@gmail.com	<u>Uday Khandarkar</u>
7	Sakshi L. Barampatre	PSM	8317219372	Sakshi2002bb@gmail.com	<u>Sakshi</u>
8	Vaibhav G. Rane	PSM	774487383	Vaibhavrane2202@gmail.com	<u>Vaibhav</u>
9	Pratul G. Garkwad	PSM	7620511353	Pratulgarkwad1999@gmail.com	<u>Pratul</u>
10	Sourabh V. Raut	SCOM	95272832113	sourabh.raut412@gmail.com	<u>Raut</u>
11	Nikhil V. Gishale	SCOM	962268/477	Nihalgishale@gmail.com	<u>Nikhil</u>
12	Eshika R. Dethre	SCOM	8788139260	Eshikadethre2002@gmail.com	<u>Eshika</u>
13	Neha J. Bankar	SCOM	8055477553	neha2002bankar@gmail.com	<u>Neha</u>
14	Tanvi S. Mahule	SCOM	7057844382	tanvimahule45@gmail.com	<u>Tanvi</u>
15	Sahil R. Sutar	SCOM	9377414643	sahilsutar78@gmail.com	<u>Sutar</u>
16	Diyaa R. Patil	SCOM	7757052467	diyapatil1999@gmail.com	<u>Patil</u>
17	Komal M Kumbhar	SCOM	7620314869	kumbharkomal94@gmail.com	<u>Komal</u>
18	Sumeet Bhalekar	SCOM	9021627352	sumitbhalekar262@gmail.com	<u>Sumeet</u>
19	Jarug P. Patke	SCOM	9422438048	Jarug.P.Patke2002@gmail.com	<u>Patke</u>
20	Brunjal D. Sarwedkar	SCOM	7385458510	brunjal.sarwedkar1234@gmail.com	<u>Brunjal</u>

Signature of Teacher

Teacher Incharge



DHARAMPETH M. P. DEO MEMORIAL SCIENCE COLLEGE, NAGPUR

INTERNAL QUALITY ASSURANCE CELL (IQAC)

Activity Report

Date: 26th September 2022

Name of Organizing Department or Committee: Electronics Department

Name of the Activity : Tracing the power supply unit

Suggested CRITERION point if any: Suggested criteria II

Date of Activity: 26th September 2022

Place of Activity : Electronics Lab

Name of Guest Speaker/s or Judge/s or Chief Guest/s if any : Not applicable

Title of the Activity: Tracing the power supply unit

Based on Unit : I(Paper I)

Class : Semester III

Number of Participants: 16

Name of the Teacher In-charge/Convener: Mrs. Leena P. Thakare

OUTCOME of the Activity with respect to mission vision of the institute and or academics:

Students got to know the importance of power supply section in electronic equipments. They know how to check the connectivity of a power supply circuit.

Prof. Varsha V. Rangari

Head of the Department

Prof. Pitambar Humane

IQAC Coordinator

IQAC Co-ordinator

Dharampeth M.P. Deo Memorial
Science College, Nagpur-440013

Dr. Akhilesh Peshwe

Principal

Principal

**Dharampeth M.P. Deo Memorial
Science College, Nagpur**



DHARAMPETH M. P. DEO MEMORIAL SCIENCE COLLEGE, NAGPUR

Department of Electronics

Semester III- (2022-23)

ACTIVITY (Paper I- Unit- 1)

Sr. No.	Student Name	Mobile No.	Email ID
1	Jay Anilbhal Patil	7385436956	jay.patil0326@gmail.com
2	Urvashi Sunilrao Umathe	9527708361	pragatichaure01@gmail.com
3	Janvi Ashok Kosarkar	8975756916	Janvikosarkar@gmail.com
4	Mansi Dilip Nandanwar	7709322027	mansinandanwar19@gmail.com
5	Renuka Vishal Lande	7719951401	renukalande220@gmail.com
6	Aasmin Abdulkhaliq Sheikh	8788490684	abdulkhalik563698@gmail.com
7	Rahul Ramesh Kawade	9359525716	kawaderahul042@gmail.com
8	Chetan Umashankar Bopche	9172484628	chetanbopche27@gmail.com
9	Yash Ravindra Khedekar	7020829422	yashkhedekar5@gmail.com
10	Aditya Ravindra Singh	8999323047	aditya8999singh@gmail.com
11	Sandip Lotan Funde	9067118437	sandipfundesmc@gmail.com
12	Tushar Wadhawe		
13	Pawankumar Shivkumar Vishwakarma	7058408869	pawanvishwakarma67448@gmail.com
14	Unnatitai Chatrapal Chopde	9022627617	unnatichopde2002@gmail.com
15	Durgesh Krishna Singh	7385310432	ds608531@gmail.com
16	Bhagyarathi Ramvinay Pandey	9175302601	pandeybhagyarathi@gmail.com

Name & Signature of Teacher In-Charge

Prof. Pitambar Humane
IQAC Coordinator

CO ORDINATOR

INTERNAL QUALITY ASSURANCE CELL
DHARAMPETH, M. P. DEO MEMORIAL &
SCIENCE COLLEGE, NAGPUR

Name & Signature of Head of the Department

Dr. Varsha V. Rangari
Professor & Head
Department of Electronics
Dharampeth M.P. Deo Memorial
Science College, Nagpur

Dr. Akhilesh Peshwe
Principal
Dharampeth M.P. Deo Memorial
Science College, Nagpur.



DHARAMPETH M. P. DEO MEMORIAL SCIENCE COLLEGE, NAGPUR
INTERNAL QUALITY ASSURANCE CELL (IQAC)

Activity Report

Date: 03/10/2022

Name of Organizing Department or Committee: Chemistry

Name of the activity: NEP activity report (Sem I, paper II, Unit II-Gaseous State)

Suggested CRITERION point if any: Criteria II

Date of Activity: 26-09-2022

Place of Activity: Department of Chemistry

Name of Guest Speaker/s or Judge/s or Chief Guest/s if any- Nil

Title of the Activity: Model making for collision of molecules in a chemical reaction and model making for mean free path

Number of Participants: 41

Name of the Teacher In-charge / Convener: Dr. Mrs. Yogita Morey (Dahire)

Names of other Committee Members / Staff: Dr. Mrs. V. P. Meshram

OUTCOME of the Activity with respect to mission vision of the institute and or academics:

This is a student's centric activity. Model making for collision of molecules showing collision between the molecules and collision with the wall of the container. This model visually clears the concept of students about the collision of molecules. Model making activity for mean free path. Mean free path is the average distance. An object will move between collisions Model preparation showing free path followed by an atom.



Activity with newspaper coverage if any: Nil

Activity data saved in PC of: Chemistry Department

Note: Kindly share Jio tag photographs separately along with report on igacdsc2022@gmail.com

Prof. Pitambar Humane
IQAC Coordinator

CO ORDINATOR
INTERNAL QUALITY ASSURANCE CELL
DHARAMPETH, M. P. DEO MEMORIAL &
SCIENCE COLLEGE, NAGPUR

Name & Signature of Teacher In-charge
Dr. Mrs. Yogita Morey (Dahire)

Dr. Akhilesh Peshwe
Principal

PRINCIPAL
Dharampeth M. P. Deo Memorial
Science College, Nagpur-440033



DHARAMPETH M. P. DEO MEMORIAL SCIENCE COLLEGE,
North Ambazari Road, Near Ambazari Lake, Nagpur- 440033

DATA VALIDATION & VERIFICATION (DVV)

Activity-2 on Unit - 2
Name of the Programme : Model making activity of collision of molecules and mean free path
Date of the Programme : 26-09-2022
Name of Chief Guest if any :
Name of Guest Speaker if any :

Sr. No.	Name of the Participant	Mobile Number	E-mail Id	Signature
1.	Ruchi dwivedi	8080776893	Ruchidwivedi230@gmail.com	Ruchi
2.	Saurabh Chaudhary	9359883501	Schaudhary5599@gmail.com	Saurabh
3.	Ritika bhoyar	9834587087	ritikabhoyar28@gmail.com	Ritika
4.	monika J. Patil	7699225468	monikapatel1088@gmail.com	Patil
5.	Karishma N. Prasad	9309328667	narendraprasad72@gmail.com	Karishma
6.	Pratibha Bhusari	7821048413	pbusari718@gmail.com	PB
7.	Shital O. Patle	9764596337	shitalpatle@gmail.com	Patle
8.	Ankit Patel	9970905638	ankitpatel747275@gmail.com	Patel
9.	Saurabh Chaudhary	9359883501	Schaudhary5599@gmail.com	Saurabh
10.	Shivam Patil	7038889083	sp040263@gmail.com	shivam
11.	Durgesh K. Ghodmare	9075368618	durgeshghodmare001@gmail.com	Ghodmare
12.	Pawan E. Thakre	8262969713	thakre.pawan739@gmail.com	Thakre
13.	Mounali D. Bhilkar	9322427616	mounali.Bhilkar@gmail.com	Bhilkar
14.	Nihal v. Mesharam	9922727010	nihalmesharam@gmail.com	Nihal

Signature of:
Programme In-charge

(Dr. Mrs. Yogita Morey (Dahire))

Signature of:
CO ORDINATOR

CO ORDINATOR
INTERNAL QUALITY ASSURANCE CELL
DHARAMPETH M. P. DEO MEMORIAL &
SCIENCE COLLEGE, NAGPUR

Signature of:
PRINCIPAL

PRINCIPAL
Dharampeth M.P. Deo Memorial
Science College, Nagpur-440033



DHARAMPETH M. P. DEO MEMORIAL SCIENCE COLLEGE,
North Ambazari Road, Near Ambazari Lake, Nagpur-440033

DATA VALIDATION & VERIFICATION (DVV)

15	Nikhil R. Kumre	8262369713	Nikhil.kumre@gmail.com
16	Apeksha D Kotangale	7559455794	apeksha.kotangale26@gmail.com
17	Pranali chauhane	9699654562	Pranali.chauhane69@gmail.com
18	Neha Wanjari	9373832266	nehawanjari733@gmail.com
19	Sumaira Chichonde	8530970132	Sumaira.chichonde@gmail.com
20	Ashlesha Khadgi	7820929579	Ashlesha.khadgi@gmail.com
21	Krutika Pokale	902153341	Pokale.krutika@gmail.com
22	Gurjan Bhojar	8668335876	gurjan.bhojar34@gmail.com
23	Vishnavi Donge	8421657945	Vishnavi.donge2004@gmail.com
24	Gauri Bhojar	7666799586	Gauri.bhojar@gmail.com
25	Maheshwari Bhakar	9022137975	Maheshwari.Bhakar20@gmail.com
26	Aakansha Y. Maital	8010923662	aakansha.y.maital@gmail.com
27	Raj Meshram	9529027031	Raj.meshram1404@gmail.com
28	Khushi Bharti	9604367894	2603.khushi.bharti@gmail.com
29	Nakita Das	9446297880	Nakita.das970@gmail.com
30	Yeshika Pandey	9156085297	Pandey.kn54@gmail.com
31	Priya Sharma	8010764549	Priya.x/2007sharma@gmail.com
32	Nisha pande	8605231390	Abhishek.8605231390@gmail.com
33	Abhay P. Tambhaze	89575363145	abhayp.30102@gmail.com
34	Ludhly A Vishwakarma	9579660186	Ludhly.vishwakarma24@gmail.com
35	Kiran K. Ghuguskar	9021231607	Ghuguskar.Kiran2004@gmail.com

Signature of:
Programme In-charge

Dr. Mrs. Yogita Masay (Dahiro)

IQAC Coordinator

COORDINATOR

INTERNAL QUALITY ASSURANCE CELL
DHARAMPETH, M. P. DEO MEMORIAL &
SCIENCE COLLEGE, NAGPUR

Principal

PRINCIPAL

Dharampeth M.P. Deo Memorial
Science College, Nagpur-440033



DHARAMPETH M. P. DEO MEMORIAL SCIENCE COLLEGE, NAGPUR
INTERNAL QUALITY ASSURANCE CELL (IQAC)

Activity Report

NEP Activity 2022-23

Date: 4/10/22

Name of Organizing Department or Committee: Department of Chemistry

Name of the activity: NEP Activity

Suggested CRITERION point if any: Criterion II

Date of Activity: ~~26~~09-2022

Place of Activity: Chemistry Laboratory

Name of Guest Speaker/s or Judge/s or Chief Guest/s if any: _____

Title of the Activity: Uses of salt bridge and Demonstration of preparation of salt bridge in laboratory
(Sem V, Paper II Unit I)

Number of Participants: 40

Name of the Teacher In-charge / Convener: Dr Deepika Brijpuriya

Names of other Committee Members / Staff: Dr Vaishali Meshram

OUTCOME of the Activity with respect to mission vision of the institute and or academics:

The activity based on the concept of role of salt bridge (ion bridge) in electrochemistry. Salt bridge plays a very important role in connecting two different electrolytes for mobility of ions. The preparation of salt bridge was demonstrated to the students, with all precautions (There should not be any air bubble, both the end level should be same, etc.). By this activity, students learn to prepare salt bridge and its wide applications in electrochemistry.



Activity with newspaper coverage if any: _____

Activity data save in PC of: Department of Chemistry

Note: Kindly share geotag photographs separately along with report on iqacdsc2022@gmail.com

Prof. Pitambar Humane
IQAC Coordinator

CO ORDINATOR
INTERNAL QUALITY ASSURANCE CELL
DHARAMPETH, M. P. DEO MEMORIAL &
SCIENCE COLLEGE, NAGPUR

Dr. Deepika Brijpuriya
Name & Signature of Teacher In-charge

Dr. Akhilesh Peshwe
Principal

PRINCIPAL
Dharampeth M.P. Deo Memorial
Science College, Nagpur-440033



DHARAMPETH M. P. DEO MEMORIAL SCIENCE COLLEGE,
North Ambazari Road, Near Ambazari Lake, Nagpur-440033

DATA VALIDATION & VERIFICATION (DVV)

Name of the Programme : Uses of Salt Bridge & Demonstration of preparation of salt bridge in Laboratory
Date of the Programme : 26/09/22 CNEP Activity
Name of Chief Guest if any : _____
Name of Guest Speaker if any : _____

Sr. No.	Name of the Participant	Mobile Number	E-mail Id	Signature
1.	Kartik Adlakhia	8580997159	Kartikadlakhia@gmail.com	Kartik
2.	Chetan Kamthe	9637271601	Kamthe.chetan@gmail.com	Chetan
3.	Kaustubh Ramteke	7218487714	ramteke.kaustubh2002@gmail.com	Kaustubh
4.	Shubham Khobragade	9518788915	shubhamkhobragade2001@gmail.com	Shubham
5.	Ishwar Suryawanshi	8087317297	Suryawanshiishwar123@gmail.com	Ishwar
6.	Arpita T. Dakhale	8010866758	arpitadakhale.02@gmail.com	Arpita
7.	Jayashree D. Hiwase	7385473157	Jyashree10@gmail.com	J.D. Hiwase
8.	Neha Waghade	7249895140	nehawaghade16082002@gmail.com	Neha
9.	Mrunali Sansare	9850163812	Sansare.mrunali16@gmail.com	Mrunali
10.	Neha Kawase	8766738340	neha2002kk@gmail.com	Neha
11.	Amisha R. Ande	8767618394	aditi123@gmail.com	Amisha
12.	Tejal A. Mankar	9322458697	tejalmanekar993@gmail.com	Tejal
13.	Laxmi G. Sayam	7517793675	SayamLaxmi389@gmail.com	Laxmi
14.	Anjali Mishra	8379948166	an35869@gmail.com	Anjali

Signature of: 
Programme In-charge

ICAC Coordinator
CO ORDINATOR
INTERNAL QUALITY ASSURANCE CELL
DHARAMPETH, M. P. DEO MEMORIAL &
SCIENCE COLLEGE, NAGPUR



PRINCIPAL
Dharampeth M.P. Deo Memorial
Science College, Nagpur-440033



DHARAMPETH M. P. DEO MEMORIAL SCIENCE COLLEGE,
North Ambazari Road, Near Ambazari Lake, Nagpur-440033

DATA VALIDATION & VERIFICATION (DVV)

15.	Damini M. Bandbuche	8275105785	bondbuche.damini@gmail.com	Damini
16.	Supriya Patle	7757871925	Patlesupriya02@gmail.com	Patle
17.	Prachi K. Varabhe	9825336932	Prachivarabhe@gmail.com	Prabhathe
18.	Dolly B Gabhane	9284269236	dollygabhane7@gmail.com	Dolly
19.	Aryali Charde	8261964188	eunjalicharde20@gmail.com	Aryali
20.	Akansha S. Bhute	9356964121	akanshabhute2020@gmail.com	Akansha
21.	Priyanka L. Gurwar	9579263881	Priyankagurwar2000@gmail.com	Priyanka
22.	Sushila Pusti	7507439390	Sushilapusti22@gmail.com	Pusti
23.	Sonam Uprade	9890230462	Sonamuprade@gmail.com	Sonam
24.	Rakhi Gedam	7378312504	gedamrakhi2000@gmail.com	Rakhi
25.	Vanshika Yede	7558244609	Vanshikayede19@gmail.com	Vanshika
26.	Anshuman Sharma	9370892462	anshumansharma19@gmail.com	Anshuman
27.	Vishal Kumar Singh	9610187223	singhvishal9602@gmail.com	Vishal
28.	vaisnavi R. Chandekar	7247882964	vaisnavichandekar@gmail.com	Chandekar
29.	Pallavi Y. Bhagat	9022650940	Pallaviy2002@gmail.com	Bhagat
30.	Anushka S. Das	7058933157	ad04092001@gmail.com	Anushka
31.	Akansha R. Yelure	8767935524	akanshayelure@gmail.com	Akansha
32.	Chatali M. Burebade	9359540394	Chatali20206@gmail.com	Chatali
33.	Pragya R. Jha	9665852975	pragyaj1697@gmail.com	Jha
34.	Muskan Sheikh			Muskan
35.	Tanushree Date			Date

Signature of: 
Programme In-charge

ICAA Co-ordinator
CO-ORDINATOR

INTERNAL QUALITY ASSURANCE CELL
DHARAMPETH, M. P. DEO MEMORIAL &
SCIENCE COLLEGE, NAGPUR

PRINCIPAL

Dharampeth M.P. Deo Memorial
Science College, Nagpur-440033



DHARAMPETH M. P. DEO MEMORIAL SCIENCE COLLEGE,
North Ambazari Road, Near Ambazari Lake, Nagpur-440033

DATA VALIDATION & VERIFICATION (DVV)

36.	Pratham Gupta	9697250837		<u>Pratham</u>
37.	Nitin Harinkhede	9561179324	harinkhede.nitin@gmail.com	<u>Nitin</u>
38.	Mukesh Dhan	9359540384		<u>Mukesh</u>
39.	Nikita Rahangdale	9307723308	nikitarahangdale2005@gmail.com	<u>Nikita</u>
40.	Balraj Wada	930290209		<u>Balraj</u>

Signature of: Nikita
Programme In-charge

[Signature]
IQAC Coordinator
CO ORDINATOR
INTERNAL QUALITY ASSURANCE CELL
DHARAMPETH, M. P. DEO MEMORIAL &
SCIENCE COLLEGE, NAGPUR

Principal
PRINCIPAL
Dharampeth M.P. Deo Memorial
Science College, Nagpur-440033



DHARAMPETH M. P. DEO MEMORIAL SCIENCE COLLEGE, NAGPUR
INTERNAL QUALITY ASSURANCE CELL (IQAC)

Activity Report

Date: 24th September 2022

Name of Organizing Department or Committee: Electronics Department
Name of the Activity : Poster making of 'Block Diagram of 8085' (NEP)
Suggested CRITERION point if any: Suggested criteria II
Date of Activity: 24th September 2022
Place of Activity : Electronics Lab

Name of Guest Speaker/s or Judge/s or Chief Guest/s if any : Not applicable

Title of the Activity: Poster making of 'Block Diagram of 8085'
Based on Unit : 1(Paper II)
Class : Semester V
Number of Participants: 20

Name of the Teacher In-charge / Convener: Prof. V. V. Rangari

OUTCOME of the Activity with respect to mission vision of the institute and or academics:

Students learn about the architecture of 8085 Microprocessor. Each block was explained to the students in detail so that they can understand how the 8085 microprocessor works.

Prof. Varsha V. Rangari

Head of the Department

Prof. Pitambar Humane

IQAC Coordinator

CO ORDINATOR

**INTERNAL QUALITY ASSURANCE CELL
DHARAMPETH, M. P. DEO MEMORIAL &
SCIENCE COLLEGE, NAGPUR**

Dr. Akhilesh Peshwe

Principal
**Dharampeth M.P. Deo Memorial
Science College, Nagpur.**



Dharampeth M. P. Deo Memorial Science College,
Nagpur

Electronics Department
Semester V - (2022-23)

Activity 1
Based on Paper II -Unit 1

Date: 24/09/2022

Activity: Poster making of "Block Diagram of 8085".

Sr. No.	Students Name	Signature
1.	NSKHIZ Ijankar	
2.	Pratham Sonar	
3]	Mukund Hood	
4]	Rajat Rohad	
5]	Bhavesh Maske	
6]	Mahesh Maske	
7]	Sagar Sonwane	
8]	Umesh Jadhav	
9]	Aniket Sonwane	
10]	Aarti Singh	
11]	Kiran Waghade	
12]	Sakshi Huddar	
13]	Sakshi Hiwarkar	
14]	Soniya Chariya	
15]	Tanmay S. Gadgil	
16]	Pranav S. Mahajan	
17]	Prakash M. Khanal	
18]	Saurabh P. Sharma	
19]	Rani D. Khatke	

20] ABHIJEEET MANKAR

~~20]~~



DHARAMPETH M. P. DEO MEMORIAL SCIENCE COLLEGE, NAGPUR

Department of Electronics

Semester V- (2022-23)

ACTIVITY (Paper II - Unit- 1)

Sr. No.	Student Name	Mobile Number	Email ID
1	Nikhil Kiran Jankar	8530960407	nikhilijankar@gmail.com
2	Pratham Manbahadur Sonar	7558464862	manbhaisonar@gmail.com
3	Mukund Sanjay Hood	9604785822	mukundahood2003@gmail.com
4	Rajat Laxman Rohad	9175635273	
5	Bhavesh Rameshwar Maske	7489951631	bhaveshmaske2002@gmail.com
6	Mahesh Prabhakarrao Maske	9021951173	maheshmaske48@gmail.com
7	Sagar Omprakash Sonwane	9356591564	sagarsonwane706@gmail.com
8	Samiksha Vasant Tabhane	9307133863	samikshavtabhane@gmail.com
9	Ankita Laxman Sonwane	9284801790	ankitasonwane10@gmail.com
10	Aarti Brijkishor Singh	7709208740	aartibsingh222@gmail.com
11	Kiran Ramesh Waghade	9860218676	rameshwaghade20@gmail.com
12	Sakshi Sanjay Huddar	9405142450	huddarmahi@gmail.com
13	Sakshi Satish Hiwarkar	9356651344	Sakshihiwarkar1831@gmail.com
14	Soniya Bhishamber Chaniya	7028563411	rvchaniya@gmail.com
15	Tanmay Sunil Gadam	7262034396	tanmaygadaml@gmail.com
16	Pranav Santosh Mahajan	9158377419	pranaymahajan413@gmail.com
17	Prakash Madhurvilas Khanal	7796875388	Khanalprakash151@gmail.com
18	Saurabh Pratap Sharma	9130964601	saurabhs44002@gmail.com
19	Rani Devidas Kokate	7998945148	ranikokate1009@gmail.com
20	Abhijeet Shrikant Mankar	8309664405	abhijeetmankar5@gmail.com

Name & Signature of Teacher In-Charge

Prof. Pitambar Humane
IQAC Coordinator

CO ORDINATOR

INTERNAL QUALITY ASSURANCE CELL
DHARAMPETH, M. P. DEO MEMORIAL &
SCIENCE COLLEGE, NAGPUR

Name & Signature of Head of the Department

Dr. Akhilesh Peshwe
Principal

Principal

Dharampeth M.P. Deo Memorial
Science College, Nagpur.



DHARAMPETH M. P. DEO MEMORIAL SCIENCE COLLEGE, NAGPUR

INTERNAL QUALITY ASSURANCE CELL (IQAC)

Activity Report

Date: 24th September 2022

Name of Organizing Department or Committee: Electronics Department

Name of the Activity : Solving worksheet on Number systems(NEP)

Suggested CRITERION point if any: Suggested criteria II

Date of Activity: 24th September 2022

Place of Activity : Electronics Lab

Name of Guest Speaker/s or Judge/s or Chief Guest/s if any : Not applicable

Title of the Activity: Solving worksheet on Number systems

Based on Unit : I(Paper II)

Class : Semester I

Number of Participants: 19

Name of the Teacher In-charge / Convener: Mrs. Leena P. Thakare

OUTCOME of the Activity with respect to mission vision of the institute and or academics:

Students learn different number systems in digital electronics. They are aware about how to convert the given number into different number systems.

Prof. Varsita V. Rangari

Head of the Department



Prof. Pitambar Humane

IQAC Coordinator

CO ORDINATOR

INTERNAL QUALITY ASSURANCE CELL
DHARAMPETH, M. P. DEO MEMORIAL &
SCIENCE COLLEGE, NAGPUR



Dr. Akhilesh Peshwe

Principal

Dharampeth M.P. Deo Memorial
Science College, Nagpur.



Dharampeth M. P. Deo Memorial Science College,
Nagpur

Electronics Department
Semester I - (2022-23)

Activity 3

Based on Paper II -Unit 1

Date: 24/09/2022

Activity: Solving worksheet on Number Systems.

Sr. No.	Students Name	Signature
1.	Isha Waghmare	
2.	Ved. S. Choudhary	
3.	Vedant O. Umekar	
4.	Harshata Garkhede	
5.	Tejas Dongre	
6.	Tushal Achare	
7.	Vaidhree B. Gargal	
8.	TANU .A. SINGH	
9.	Simran Dhimale	
10.	Abhishek Singh	
11.	Khushbu Pali	
12.	Jannu Varthia	
13.	Khushi Pali	
14.	Yogita J. Kadam	
15.	Kashish Bisen	
16.	Uday C. Baghale	
17.	Bhagyashali D. Deware	
18.	Deepak Karmare	
19.	Vineet M. Singh	



DHARAMPETH M. P. DEO MEMORIAL SCIENCE COLLEGE, NAGPUR

Department of Electronics

Semester I- (2022-23)

Activity (Paper II - Unit- 1)

Sr. No.	Student Name	Mobile Number	Email ID
1	Isha Ishwar Waghmare	8855919474	ishawaghmare9474@gmail.com
2	Ved Sudhir Choudhary	7498572766	vedchoudhary.cs.749@gmail.com
3	Vedant Onkar Umretkar	9049932753	umretkarvedant@gmail.com
4	Harshata Gunderao Warkhede	9860432428	bandukeshao20@gmail.com
5	Tejas Ramesh Dongre	9322578918	tejasdongre453@gmail.com
6	Tushal Rupkumar Achare	9075995617	acharetushal5@gmail.com
7	Vaidhavi Baburao Gongal	7507907278	gayatrigongal787@gmail.com
8	Tanu Ajay Singh	8806355808	tanusingh63492@gmail.com
9	Simran Narendra Dhimole	8390347026	mishralaxmi210@gmail.com
10	Abhishek Ravindra Singh	8208948107	abhi0882005@gmail.com
11	Khushbu Rajiv Pali	8459565214	palikhushbu59@gmail.com
12	Tannu Arun Varthi	9322044903	tannuvarthi@gmail.com
13	Khushi Rajiv Pali	8767607224	palikhushi4@gmail.com
14	Yogita Jaysing Karemore	8381045307	swara.karemore25@gmail.com
15	Kashish Kamalkumar Bisen	7887886117	kashishbisen05@gmail.com
16	Uday Chandrashekhar Baghele	8459549609	bagheleuday@gmail.com
17	Bhagyashali Dadarao Neware	7796434177	sakshineware2017@gmail.com
18	Deepak Surendra Kumar Kumar	7061735473	gauravasharma2@gmail.com
19	Vineet Mukesh Singh	9766035354	vineetsingh3533@gmail.com

Name & Signature of Teacher In-Charge

Prof. Pitambar Humane
IQAC Coordinator

CO ORDINATOR
INTERNAL QUALITY ASSURANCE CELL
DHARAMPETH, M. P. DEO MEMORIAL &
SCIENCE COLLEGE, NAGPUR

Name & Signature of Head of the Department

Dr. Varsha V. Rangari
Professor & Head
Department of Electronics
Dharampeth M.P. Deo Memorial

Science College, Nagpur

Dr. Akhilesh Peshwe
Principal
Dharampeth M.P. Deo Memorial
Science College, Nagpur.



DHARAMPETH M. P. DEO MEMORIAL SCIENCE COLLEGE, NAGPUR

INTERNAL QUALITY ASSURANCE CELL (IQAC)
Activity Report

Date: 26/09/2022

Name of Organizing Department or Committee: Department of Statistics

Name of the activity: Activity on Estimation of average height

Suggested CRITERION point if any: Restricted to RTMNU BSc Statistics syllabus.

Date of Activity: 26/09/2022

Place of Activity: Statistics Lab

Name of Guest Speaker/s or Judge/s or Chief Guest/s if any: NA

Title of the Activity: Estimation of average height of students (Girls and Boys)

Activity with newspaper coverage if any: No

Number of Participants: 20

Name of the Teacher: Ms. Kumudini Kadbe

Names of other Committee Members / Staff: N.A.

OUTCOME of the Activity with respect to academics:

Using this activity students will also be able to estimate the height of a few objects that they can measure (small tree, sign post, fence) to see how close their estimation is to the actual height.

DVV: Enclosed.

Activity data save in PC of: Lt. Dr. P. W. Ambekar

Prof. Pitambar Humane
IQAC Coordinator

CO ORDINATOR
INTERNAL QUALITY ASSURANCE CELL
DHARAMPETH, M. P. DEO MEMORIAL &
SCIENCE COLLEGE, NAGPUR

Name & Signature of Teacher In-charge

Dr. Akhilesh Peshwe
Principal

Principal
Dharampeth M.P. Deo Memorial
Science College, Nagpur.



DHARAMPETH M. P. DEO MEMORIAL SCIENCE COLLEGE NAGPUR

Department of Statistics

Class: B.Sc. Sem.-V

NEP ACTIVITY

Paper- II

Unit- I

Name of the Teacher: Kumudini Kadbe

Date: 26/09/22

Title of Activity: Estimation of average height of students

Sr. No.	Name of Student	Batch	Mobile No.	Email ID	Signature
1	Prachi S. Manu Smarve	PSM (TH)	9336969609	prachimanusmarve@gmail.com	<u>Prachi Smarve</u>
2	Himanshu R. Lakhe	PSM	7648252469	himanshulakhe08@gmail.com	<u>Lakhe</u>
3	Piyush G. Kapse	PSM	9373563023	Kapsepiyush02@gmail.com	<u>Piyush</u>
4	Pratiksha S. Thakre	PSM	8459520299	Pratikshathakre199@gmail.com	<u>Pratiksha</u>
5	Divyani U. Dhule	PSM	7030731921	divyandhule2002@gmail.com	<u>Divyani Dhule</u>
6	Uday P. Khandarkar	PSM	9545897196	udaykhandarkar98@gmail.com	<u>Uday</u>
7	Sakshi L. Barampatre	PSM	8317219372	Sakshi2002bb@gmail.com	<u>Sakshi</u>
8	Vaibhav G. Rane	PSM	7744857383	Vaibhav2002@gmail.com	<u>Vaibhav</u>
9	Pratul G. Garkwad	PSM	7620511353	Pratulgarkwad1999@gmail.com	<u>Pratul</u>
10	Sourabh V. Raut	SCOM	95272832113	sourabhvraut123@gmail.com	<u>Raut</u>
11	Nikhil V. Gishale	SCOM	962268/477	Nihalgishale@gmail.com	<u>Nikhil</u>
12	Eshika R. Dethre	SCOM	8788139260	Eshikadethre2002@gmail.com	<u>Eshika</u>
13	Neha J. Bankar	SCOM	8055477553	nehaj2002bankar@gmail.com	<u>Neha</u>
14	Tanvi S. Mahule	SCOM	7057844382	tanvimahule45@gmail.com	<u>Tanvi</u>
15	Sahil R. Sutar	SCOM	9377414643	sahilsutar7@gmail.com	<u>Sutar</u>
16	Diyaa R. Patil	SCOM	7757052467	diyapatil1999@gmail.com	<u>Diya</u>
17	Komal M Kumbhar	SCOM	7620314869	kumbharkomal94@gmail.com	<u>Komal</u>
18	Sumeet Bhalekar	SCOM	9021627352	sumitbhalekar262@gmail.com	<u>Sumeet</u>
19	Jarug P. Patke	SCOM	9422438048	Jarug.P.Patke2002@gmail.com	<u>Patke</u>
20	Brunjal D. Sarwedkar	SCOM	7385458510	brunjalSarwedkar1234@gmail.com	<u>Brunjal</u>

Signature of Teacher

Teacher Incharge



DHARAMPETH M. P. DEO MEMORIAL SCIENCE COLLEGE, NAGPUR

INTERNAL QUALITY ASSURANCE CELL (IQAC)

Activity Report

Date: 26th September 2022

Name of Organizing Department or Committee: Electronics Department

Name of the Activity : Tracing the power supply unit

Suggested CRITERION point if any: Suggested criteria II

Date of Activity: 26th September 2022

Place of Activity : Electronics Lab

Name of Guest Speaker/s or Judge/s or Chief Guest/s if any : Not applicable

Title of the Activity: Tracing the power supply unit

Based on Unit : I(Paper I)

Class : Semester III

Number of Participants: 16

Name of the Teacher In-charge/Convener: Mrs. Leena P. Thakare

OUTCOME of the Activity with respect to mission vision of the institute and or academics:

Students got to know the importance of power supply section in electronic equipments. They know how to check the connectivity of a power supply circuit.

Prof. Varsha V. Rangari

Head of the Department

Prof. Pitambar Humane

IQAC Coordinator

IQAC Co-ordinator

Dharampeth M.P. Deo Memorial
Science College, Nagpur-440013

Dr. Akhilesh Peshwe

Principal

Principal

**Dharampeth M.P. Deo Memorial
Science College, Nagpur**



DHARAMPETH M. P. DEO MEMORIAL SCIENCE COLLEGE, NAGPUR

Department of Electronics

Semester III- (2022-23)

ACTIVITY (Paper I- Unit- 1)

Sr. No.	Student Name	Mobile No.	Email ID
1	Jay Anilbhal Patil	7385436956	jay.patil0326@gmail.com
2	Urvashi Sunilrao Umathe	9527708361	pragatichaure01@gmail.com
3	Janvi Ashok Kosarkar	8975756916	Janvikosarkar@gmail.com
4	Mansi Dilip Nandanwar	7709322027	mansinandanwar19@gmail.com
5	Renuka Vishal Lande	7719951401	renukalande220@gmail.com
6	Aasmin Abdulkhalik Sheikh	8788490684	abdulkhalik563698@gmail.com
7	Rahul Ramesh Kawade	9359525716	kawaderahul042@gmail.com
8	Chetan Umashankar Bopche	9172484628	chetanbopche27@gmail.com
9	Yash Ravindra Khedekar	7020829422	yashkhedekar5@gmail.com
10	Aditya Ravindra Singh	8999323047	aditya8999singh@gmail.com
11	Sandip Lotan Funde	9067118437	sandipfundesmc@gmail.com
12	Tushar Wadhawe		
13	Pawankumar Shivkumar Vishwakarma	7058408869	pawanvishwakarma67448@gmail.com
14	Unnatitai Chatrapal Chopde	9022627617	unnatichopde2002@gmail.com
15	Durgesh Krishna Singh	7385310432	ds608531@gmail.com
16	Bhagyarathi Ramvinay Pandey	9175302601	pandeybhagyarathi@gmail.com

Name & Signature of Teacher In-Charge

Prof. Pitambar Humane
IQAC Coordinator

CO ORDINATOR
INTERNAL QUALITY ASSURANCE CELL
DHARAMPETH, M. P. DEO MEMORIAL &
SCIENCE COLLEGE, NAGPUR

Name & Signature of Head of the Department

Dr. Varsha V. Rangari
Professor & Head
Department of Electronics
Dharampeth M.P. Deo Memorial
Science College, Nagpur

Dr. Akhilesh Peshwe
Principal
Dharampeth M.P. Deo Memorial
Science College, Nagpur.



DHARAMPETH M. P. DEO MEMORIAL SCIENCE COLLEGE, NAGPUR
INTERNAL QUALITY ASSURANCE CELL (IQAC)

Activity Report

Date: 03/10/2022

Name of Organizing Department or Committee: Chemistry

Name of the activity: NEP activity report (Sem I, paper II, Unit II-Gaseous State)

Suggested CRITERION point if any: Criteria II

Date of Activity: 26-09-2022

Place of Activity: Department of Chemistry

Name of Guest Speaker/s or Judge/s or Chief Guest/s if any- Nil

Title of the Activity: Model making for collision of molecules in a chemical reaction and model making for mean free path

Number of Participants: 41

Name of the Teacher In-charge / Convener: Dr. Mrs. Yogita Morey (Dahire)

Names of other Committee Members / Staff: Dr. Mrs. V. P. Meshram

OUTCOME of the Activity with respect to mission vision of the institute and or academics:

This is a student's centric activity. Model making for collision of molecules showing collision between the molecules and collision with the wall of the container. This model visually clears the concept of students about the collision of molecules. Model making activity for mean free path. Mean free path is the average distance. An object will move between collisions Model preparation showing free path followed by an atom.



Activity with newspaper coverage if any: Nil

Activity data saved in PC of: Chemistry Department

Note: Kindly share Jio tag photographs separately along with report on igacdsc2022@gmail.com

Prof. Pitambar Humane
IQAC Coordinator

CO ORDINATOR
INTERNAL QUALITY ASSURANCE CELL
DHARAMPETH, M. P. DEO MEMORIAL &
SCIENCE COLLEGE, NAGPUR

Name & Signature of Teacher In-charge
Dr. Mrs. Yogita Morey (Dahire)

Dr. Akhilesh Peshwe
Principal

PRINCIPAL
Dharampeth M. P. Deo Memorial
Science College, Nagpur-440033



DHARAMPETH M. P. DEO MEMORIAL SCIENCE COLLEGE,
North Ambazari Road, Near Ambazari Lake, Nagpur- 440033

DATA VALIDATION & VERIFICATION (DVV)

Activity-2 on Unit - 2

Name of the Programme : Model making activity of collision of molecules and mean free path

Date of the Programme : 26-09-2022

Name of Chief Guest if any : _____

Name of Guest Speaker if any : _____

Sr. No.	Name of the Participant	Mobile Number	E-mail Id	Signature
1.	Ruchi dwivedi	8080776893	Ruchidwivedi230@gmail.com	
2.	Saurabh Chaudhary	9359883501	Schaudhary5599@gmail.com	
3.	Ritika bhoyar	9834587087	ritikabhoyar28@gmail.com	
4.	monika J. Patil	7699225468	monikapatel1088@gmail.com	
5.	Karishma N. Prasad	9309328667	narendrprasad72@gmail.com	
6.	Pratibha Bhusari	7821048413	pbhusari718@gmail.com	
7.	Shital O. Patle	9764596337	shitalpatle@gmail.com	
8.	Ankit Patel .	9970905638	ankitpatel747275@gmail.com	
9.	Saurabh Chaudhary	9359883501	Schaudhary5599@gmail.com	
10.	Shivam Patil	7038889083	sp040263@gmail.com	
11.	Durgesh K. Ghodmare	9075368618	durgeshghodmare001@gmail.com	
12.	Pawan E. Thakre	8262969713	thakre pawan739@gmail.com	
13.	Mounali D. Bhilkar	9322427616	mounali Bhilkar@gmail.com	
14.	Nihal v. Mesharam	9922727010	nihalmesharam@gmail.com	

Signature of:
Programme In-charge

(Dr. Mrs. Yogita Morey (Dahire))

Signature of:
CO ORDINATOR

INTERNAL QUALITY ASSURANCE CELL
DHARAMPETH M. P. DEO MEMORIAL & SCIENCE COLLEGE, NAGPUR

Signature of:
PRINCIPAL

PRINCIPAL
Dharampeth M.P. Deo Memorial
Science College, Nagpur-440033



DHARAMPETH M. P. DEO MEMORIAL SCIENCE COLLEGE,
North Ambazari Road, Near Ambazari Lake, Nagpur-440033

DATA VALIDATION & VERIFICATION (DVV)

15	Nikhil R. Kumre	8262369713	Nikhil.kumre@gmail.com
16	Apeksha D Kotangale	7559455794	apeksha.kotangale26@gmail.com
17	Pranali chauhane	9699654562	Pranali.chauhane69@gmail.com
18	Neha Wanjari	9373832266	nehawanjari733@gmail.com
19	Sumaira Chichonde	8530970132	Sumaira.chichonde@gmail.com
20	Ashlesha Khadgi	7820929579	Ashlesha.khadgi@gmail.com
21	Krutika Pokale	902153341	Pokale.krutika@gmail.com
22	Gurjan Bhoyar	8668335876	gurjan.bhojar34@gmail.com
23	Vishnavi Donge	8421657945	Vishnavi.donge2004@gmail.com
24	Gauri Bhoyar	7666799586	Gauri.bhojar@gmail.com
25	Maheshwari Bhakar	9022137975	Maheshwari.Bhakar20@gmail.com
26	Aakansha Y. Maital	8010923662	aakansha.y.maital@gmail.com
27	Raj Meshram	9529027031	Raj.meshram1404@gmail.com
28	Khushi Bharti	9604367894	2603.khushi.bharti@gmail.com
29	Nakita Das	9446297880	Nakita.das970@gmail.com
30	Yeshika Pandey	9156085297	Pandey.kn54@gmail.com
31	Priya Sharma	8010764549	Priya.x/2007sharma@gmail.com
32	Nisha pande	8605231390	Abhishek.8605231390@gmail.com
33	Abhay P. Tambhaze	89575363145	abhayp.30102@gmail.com
34	Ludhly A Vishwakarma	9579660186	Ludhly.vishwakarma24@gmail.com
35	Kiran K. Ghuguskar	9021231607	Ghuguskar.Kiran2004@gmail.com

Signature of:
Programme In-charge

Dr. Mrs. Yogita Masoy (Dahiro)

IQAC Coordinator

COORDINATOR

INTERNAL QUALITY ASSURANCE CELL
DHARAMPETH, M. P. DEO MEMORIAL &
SCIENCE COLLEGE, NAGPUR

Principal

PRINCIPAL

Dharampeth M.P. Deo Memorial
Science College, Nagpur-440033



DHARAMPETH M. P. DEO MEMORIAL SCIENCE COLLEGE,
North Ambazari Road, Near Ambazari Lake, Nagpur- 440033

DATA VALIDATION & VERIFICATION (DVV)

36	Sejal D. Kolhe	8483045985	KolheSejal04@gmail.com (Kolhe)
37	Riya Rajbhar	8600256951	riyaraibhar18@gmail.com (Rij)
38	Amisha Ankara	7666559171	Amishakarankarapoo@gmail.com (Amisha)
39	Aasiya S. Hussein	70664114118	AasiyaMphishwari034@gmail.com (A Hussein)
40	Ghanashree Dhamre	8459807047	ghanashree.dhamre@gmail.com (Ghanashree)
41	Jeet S. Pardhi	7020215431	jeet.pardhi111@gmail.com (Pardhi)

Signature of:
Programme In-charge

Do. Mrs. Yagita Maray (Dahule)

IQAC Coordinator
CO ORDINATOR
INTERNAL QUALITY ASSURANCE CELL
DHARAMPETH, M. P. DEO MEMORIAL &
SCIENCE COLLEGE, NAGPUR

Principal
PRINCIPAL
Dharampeth M.P. Deo Memorial
Science College, Nagpur-440033



DHARAMPETH M. P. DEO MEMORIAL SCIENCE COLLEGE, NAGPUR
INTERNAL QUALITY ASSURANCE CELL (IQAC)

Activity Report

NEP Activity 2022-23

Date: 4/10/22

Name of Organizing Department or Committee: Department of Chemistry

Name of the activity: NEP Activity

Suggested CRITERION point if any: Criterion II

Date of Activity: ~~26~~09-2022

Place of Activity: Chemistry Laboratory

Name of Guest Speaker/s or Judge/s or Chief Guest/s if any: _____

Title of the Activity: Uses of salt bridge and Demonstration of preparation of salt bridge in laboratory
(Sem V, Paper II Unit I)

Number of Participants: 40

Name of the Teacher In-charge / Convener: Dr Deepika Brijpuriya

Names of other Committee Members / Staff: Dr Vaishali Meshram

OUTCOME of the Activity with respect to mission vision of the institute and or academics:

The activity based on the concept of role of salt bridge (ion bridge) in electrochemistry. Salt bridge plays a very important role in connecting two different electrolytes for mobility of ions. The preparation of salt bridge was demonstrated to the students, with all precautions (There should not be any air bubble, both the end level should be same, etc.). By this activity, students learn to prepare salt bridge and its wide applications in electrochemistry.



Activity with newspaper coverage if any: _____

Activity data save in PC of: Department of Chemistry

Note: Kindly share geotag photographs separately along with report on iqacdsc2022@gmail.com

Prof. Pitambar Humane
IQAC Coordinator

CO ORDINATOR
INTERNAL QUALITY ASSURANCE CELL
DHARAMPETH, M. P. DEO MEMORIAL &
SCIENCE COLLEGE, NAGPUR

Dr. Deepika Brijpuriya
Name & Signature of Teacher In-charge

Dr. Akhilesh Peshwe
Principal

PRINCIPAL
Dharampeth M.P. Deo Memorial
Science College, Nagpur-440033



DHARAMPETH M. P. DEO MEMORIAL SCIENCE COLLEGE,
North Ambazari Road, Near Ambazari Lake, Nagpur-440033

DATA VALIDATION & VERIFICATION (DVV)

Name of the Programme : Uses of Salt Bridge & Demonstration of preparation of salt bridge in Laboratory
Date of the Programme : 26/09/22 CNEP Activity
Name of Chief Guest if any : _____
Name of Guest Speaker if any : _____

Sr. No.	Name of the Participant	Mobile Number	E-mail Id	Signature
1.	Kartik Adlakhia	8580997159	Kartikadlakhia@gmail.com	Kartik
2.	Chetan Kamthe	9637271601	Kamthe.chetan@gmail.com	Chetan
3.	Kaustubh Ramteke	7218487714	ramteke.kaustubh2002@gmail.com	Kaustubh
4.	Shubham Khobragade	9518788915	shubhamkhobragade2001@gmail.com	Shubham
5.	Ishwar Suryawanshi	8087317297	Suryawanshiishwar123@gmail.com	Ishwar
6.	Arpita T. Dakhale	8010866758	arpitadakhale.02@gmail.com	Arpita
7.	Jayashree D. Hiwase	7385473157	Jyashree10@gmail.com	J.D. Hiwase
8.	Neha Waghade	7249895140	nehawaghade16082002@gmail.com	Neha
9.	Mrunali Sansare	9850163812	Sansare.mrunali16@gmail.com	Mrunali
10.	Neha Kawase	8766738340	neha2002kk@gmail.com	Neha
11.	Amisha R. Ande	8767618394	aditi123@gmail.com	Amisha
12.	Tejal Mankar	9322458697	tejalmanekar993@gmail.com	Tejal
13.	Laxmi G. Sayam	7517793675	SayamLaxmi389@gmail.com	Laxmi
14.	Anjali Mishra	8379948166	anj35869@gmail.com	Anjali

Signature of: 
Programme In-charge

ICAC Coordinator
CO ORDINATOR
INTERNAL QUALITY ASSURANCE CELL
DHARAMPETH, M. P. DEO MEMORIAL &
SCIENCE COLLEGE, NAGPUR



PRINCIPAL
Dharampeth M.P. Deo Memorial
Science College, Nagpur-440033



DHARAMPETH M. P. DEO MEMORIAL SCIENCE COLLEGE,
North Ambazari Road, Near Ambazari Lake, Nagpur-440033

DATA VALIDATION & VERIFICATION (DVV)

15.	Damini M. Bandbuche	8275105785	bandbuche.damini@gmail.com	Damini
16.	Supriya Patle	7757871925	PatleSupriya02@gmail.com	Patle
17.	Prachi K. Varabhe	9825336932	Prachivarabhe@gmail.com	Prabha
18.	Dolly B. Gabhane	9284269236	dollygabhane7@gmail.com	Dolly
19.	Aryali Charde	8261964188	euryalicharde20@gmail.com	Aryali
20.	Akansha S. Bhute	9356964121	akanshabhute2020@gmail.com	Akansha
21.	Priyanka L. Gurwar	9579263881	Priyankagurwar2000@gmail.com	Priyanka
22.	Sushila Pusti	7507439390	Sushilapusti22@gmail.com	Pusti
23.	Sonam Uprade	9890230462	Sonamuprade@gmail.com	Sonam
24.	Rakhi Gedam	7378312504	gedamrakhi2000@gmail.com	Rakhi
25.	Vanshika Yede	7558244609	Vanshikayede19@gmail.com	Vanshika
26.	Anshuman Sharma	9370892462	anshumansharma19@gmail.com	Anshuman
27.	Vishal Kumar Singh	9610187223	singhvishal9602@gmail.com	Vishal
28.	vaisnavi R. Chandekar	7247882964	vaisnavichandekar@gmail.com	Chandekar
29.	Pallavi Y. Bhagat	9022650940	Pallaviy2002@gmail.com	Bhagat
30.	Anushka S. Das	7058933157	ad04092001@gmail.com	Anushka
31.	Akansha R. Yelure	8767935524	akanshayelure@gmail.com	Akansha
32.	Chatali M. Burebade	9359540394	Chatali20206@gmail.com	Chatali
33.	Pragya R. Jha	9665852975	pragyaj1697@gmail.com	Jha
34.	Muskan Sheikh			Muskan
35.	Tanushree Date			Date

Signature of: 
Programme In-charge

CO-ORDINATOR

INTERNAL QUALITY ASSURANCE CELL
DHARAMPETH, M. P. DEO MEMORIAL &
SCIENCE COLLEGE, NAGPUR

PRINCIPAL

Dharampeth M.P. Deo Memorial
Science College, Nagpur-440033



DHARAMPETH M. P. DEO MEMORIAL SCIENCE COLLEGE,
North Ambazari Road, Near Ambazari Lake, Nagpur-440033

DATA VALIDATION & VERIFICATION (DVV)

36.	Pratham Gupta	9697250837		
37.	Nitin Harinkhede	9561179324	harinkhede.nitay@gmail.com	
38.	Mukesh Osoan	9359540384		
39.	Nikita Rahangdale	9307723308	nikitarahangdale2015@gmail.com	
40.	Balraj Wada	930290209		

Signature of:
Programme Incharge

IQAC Coordinator
CO ORDINATOR
INTERNAL QUALITY ASSURANCE CELL
DHARAMPETH, M. P. DEO MEMORIAL &
SCIENCE COLLEGE, NAGPUR

Principal
PRINCIPAL
Dharampeth M.P. Deo Memorial
Science College, Nagpur-440033



DHARAMPETH M. P. DEO MEMORIAL SCIENCE COLLEGE, NAGPUR
INTERNAL QUALITY ASSURANCE CELL (IQAC)
Activity Report

Date: 03/10/2022

Name of Organizing Department or Committee: Chemistry

Name of the activity: NEP activity report (Sem I, paper II, Unit II-Gaseous State)

Suggested CRITERION point if any: Criteria II

Date of Activity: 26-09-2022

Place of Activity: Department of Chemistry

Name of Guest Speaker/s or Judge/s or Chief Guest/s if any- Nil

Title of the Activity: Identification of Ideal and real gases

Number of Participants: 41

Name of the Teacher In-charge / Convener: Dr. Mrs. Yogita Morey (Dahire)

Names of other Committee Members / Staff: Dr. Mrs. V. P. Meshram

OUTCOME of the Activity with respect to mission vision of the institute and or academics:

This is a student's centric activity. Model making for collision of molecules showing collision between the molecules and collision with the wall of the container. This model visually clears the concept of students about the collision of molecules. Model making activity for mean free path. Mean free path is the average distance. An object will move between collisions Model preparation showing free path followed by an atom.



Activity with newspaper coverage if any: Nil

Activity data saved in PC of: Chemistry Department

Note: Kindly share Jio tag photographs separately along with report on iqacdsc2022@gmail.com

Prof. Pitambar Humane
IQAC Coordinator

CO ORDINATOR
INTERNAL QUALITY ASSURANCE CELL
DHARAMPETH, M. P. DEO MEMORIAL &
SCIENCE COLLEGE, NAGPUR

Name & Signature of Teacher In-charge
Dr. Yogita Morey (Dahire)

Dr. Akhlesh Peshwe
Principal
PRINCIPAL

Dharampeth M.P. Deo Memorial
Science College, Nagpur-440033



DHARAMPETH M. P. DEO MEMORIAL SCIENCE COLLEGE,
North Ambazari Road, Near Ambazari Lake, Nagpur- 440033

DATA VALIDATION & VERIFICATION (DVV)

Activity-2, en Unit - 2
Name of the Programme : Identification of Ideal & Real Gases
Date of the Programme : 26-09-2022
Name of Chief Guest if any : _____
Name of Guest Speaker if any : _____

Sr. No.	Name of the Participant	Mobile Number	E-mail Id	Signature
1.	Ruchi dwivedi	8080776893	Ruchidwivedi230@gmail.com	
2.	Saurabh Chaudhary	9859883501	Schaudhary5599@gmail.com	
3.	Ritika bhoyar	9834587087	ritikabhoyar28@gmail.com	
4.	monika I. Patil	7699225468	monikapatel1088@gmail.com	
5.	Karishma N. Prasad	9309328667	narendraprasad72@gmail.com	Karishma
6.	Pratibha Bhusari	7821048413	pbbhusari718@gmail.com	
7.	Shital O. Patle	9764596337	shitalpatle@gmail.com	
8.	Ankit Patel .	9970905638	ankitpatel741275@gmail.com	
9.	Saurabh Chaudhary	9859883501	Schaudhary5599@gmail.com	
10.	Shivam Patil	7038889083	sp040263@gmail.com	shivam
11.	Durgesh K. Ghodmare	9075318618	durgeshghodmare001@gmail.com	
12.	Parvin E. Thakre	8262963713	thakreparvin739@gmail.com	
13.	Mounali D. Bhilkar	9322927816	mounali Bhilkar@gmail.com	
14.	Nihal v. Meshram	9322727010	nihalmeshram@gmail.com	

Signature of:
Programme In-charge

(Dr. Mrs. Yogita Morey (Dahire))

Signature of:
CO ORDINATOR

INTERNAL QUALITY ASSURANCE CELL
DHARAMPETH M. P. DEO MEMORIAL &
SCIENCE COLLEGE, NAGPUR

Signature of:
PRINCIPAL

Dharampeth M.P. Deo Memorial
Science College, Nagpur-440033



DHARAMPETH M. P. DEO MEMORIAL SCIENCE COLLEGE,
North Ambazari Road, Near Ambazari Lake, Nagpur-440033

DATA VALIDATION & VERIFICATION (DVV)

15	Nikhil R. Kumbre	8262969713	Nikhil.kumbre@boxill.com Nile
16	Apeksha D Kotangale	7559455794	apekshadkotangale26@gmail.com @Kotangale
17	Pramati chauhane	9692654562	Pramati.chauhane69@gmail.com Pramati
18	Neha Wanjari	9373832266	nehawanjari733@gmail.com Newanjari
19	Sumaira Chichonde	8530970132	Sumaira.chichonde@gmail.com Chichonde
20	Ashlesha Khadgi	7820929579	Ashlesha.khadgi@gmail.com @Ashlesha
21	Krutika Pokale	9021533341	PokaleKrutika@gmail.com Krutika
22	Gurjan Bhojar	8668335876	gurjanbhojar34@gmail.com Gurji
23	Vaishnavi Donge	8421657945	Vaishnavi.donge2004@gmail.com Donge
24	Gauri Bhojar	7666799586	Gauri.bhojar@gmail.com Gauri
25	Maheshwari Bhakar	9022137975	Maheshwari.Bhakar@gmail.com @Mahesh
26	Aakansha Y. Maital	8010923662	aakansha.y.2004@gmail.com p.y.maital
27	Raj Meshram	9529027031	rajmeshram140@gmail.com Raj
28	Khushi Bharti	9604367894	2603khushi.bharti@gmail.com Khushi
29	Nikita Das	9446297880	Nikita.das970@gmail.com Day
30	Yashna Pandey	9156085297	Pandey.kn54@gmail.com @Yashna
31	Priya Sharma	8010764549	Priya.x/2009sharma@gmail.com Priya
32	Nisha pande	8605231390	Abhishek8605231390@gmail.com @Nisha
33	Abhay P. Tambhate	9575363145	abhayp.30102@gmail.com @Abhay
34	Judith A. Vishwakarma	9579660186	Juditha.karma24@gmail.com @Juditha
35	Kiran K. Ghuguskar	9021231607	Ghuguskar.Kiran.2004@gmail.com @K

Signature of:
Programme In-charge

Dr. Mrs. Yogita Meshy (Dahiro)

IQAC Coordinator
COORDINATOR
INTERNAL QUALITY ASSURANCE CELL
DHARAMPETH, M. P. DEO MEMORIAL &
SCIENCE COLLEGE, NAGPUR

Principal
PRINCIPAL
Dharampeth M.P. Deo Memorial
Science College, Nagpur-440033



DHARAMPETH M. P. DEO MEMORIAL SCIENCE COLLEGE, NAGPUR
INTERNAL QUALITY ASSURANCE CELL (IQAC)

Activity Report

Date: 27/10/22

Name of Organizing Department or Committee: Department of Chemistry

Name of the activity: NEP Activity B.Sc. Sem V Paper I Unit III

Suggested CRITERION point if any: Criteria II

Date of Activity: 27/9/22

Place of Activity: Chemistry lab. 3rd floor

Name of Guest Speaker/s or Judge/s or Chief Guest/s if any: Nil

Title of the Activity: Qualitative estimation of Nitrogen

Number of Participants: 26

Name of the Teacher In-charge / Convener: Dr. Sandip Madhukar Bhiwagade

Names of other Committee Members / Staff: Dr. Vaishali P. Meshram

OUTCOME of the Activity with respect to mission vision of the institute and or academics:

In this activity students know about the nitrogen containing compound, how to identify whether given compound contain nitrogen or not. In this activity students know the exact procedure how to make sodium extract and how to performed nitrogen test for given compound.

Activity with newspaper coverage if any: Nil

Activity data save in PC of: Department of Chemistry



(Dr. Sandip M. Bhiwagade
Bhiwagade)

Prof. Pitambar Humane
 IQAC Coordinator

Name & Signature of Teacher In-charge

Dr. Akhilesh Peshwe
 Principal

PRINCIPAL

Dharampeth M.P. Deo Memorial
 Science College, Nagpur-440033



DHARAMPETH M. P. DEO MEMORIAL SCIENCE COLLEGE,
North Ambazari Road, Near Ambazari Lake, Nagpur- 440033

Date 27/9/22
Qualitative estimation of
Nitrogen, Handling & working
of calorimeter

DATA VALIDATION & VERIFICATION (DVV)

1.	krushnali Sunjay kudu	8625854995	krushnali.kudu67@gmail.com	Body
2.	Bhumika Devendra Chedde	8830391103	bhumikachedde@gmail.com	Chedde
3.	Attha Abhay Sakharwade	9405197842	atthasakharwade@gmail.com	Sakharwade
4.	Avanti Ashish Chaphekar	7875173847	avanti1011@gmail.com	Avanti
5.	Poojashree Lokmikanth Dande	9325473318	danashreepoojashree@gmail.com	Poojashree
6.	Ayushi Shukla	9373668043	ayushishukla28112002@gmail.com	Shukla
7.	Anjali Namdeo Chavde	8261964188	anjalicavde20@gmail.com	Chavde
8.	Khushi Aundkar	8767279513	khushiaundkar152@gmail.com	Khushi
9.	Raksha Dhote	7498511875	rakshadhote3@gmail.com	Dhote
10.	Pallavi Bhagat	902265490	pallavi.m2208@gmail.com	Bhagat
11.	Priyanshi Singh	7219259020	priyanshisingh18040@gmail.com	Singh
12.	Chaitali M. Burbade	9359540394	chaitali2020b@gmail.com	Chaitali
13.	Anushka S. Das	7058933157	anushkasdas2001@gmail.com	Das
14.	Sakshi Surendra Moon	7745827736	sakshism3030@gmail.com	Moon
15.	Tanushree R. Dade	9766927406	tanushreedade@gmail.com	Dade
16.	Muskan H. Sheikh	8055474633	Muskan2019sss@gmail.com	Sheikh

Signature of:

Programme In-charge

CO-ORDINATOR
INTERNAL QUALITY ASSURANCE CELL
DHARAMPETH, M. P. DEO MEMORIAL &
SCIENCE COLLEGE, NAGPUR

PRINCIPAL
Dharampeth M. P. Deo Memorial
Science College, Nagpur- 440033

17.	Nikita Dipak Shebe	9021019101	nikita.shebe2019@gmail.com	<u>Nitoke</u>
18.	Aachal Shuddhodhan Wagh.	9579643389	aachalwagh2003@gmail.com	A. Wagh
19.	Sayli Sevanand Lokhande	9356413804	Sayli.lokhande2910@gmail.com	<u>Lokhande</u>
20.	Sauniksha Ramchandra Choudhary	7517090406	choudharysauniksha26@gmail.com	<u>Sfmr</u>
21.	Megha Ganjay Fulwar.	8605399606	meghafulwar@gmail.com	
22)	Prunali Sonbave	9850163812	Sonbavemrunali16@gmail.com	Prunali
23)	Vaishnavi R. Chandekar.	7249882364	Vaishnavichandekar000@gmail.com	<u>Chandekar</u>
24)	Rukhi Gjedam	7378312505	gedamrukhi2000@gmail.com	<u>R. Gjedam</u>
25)	Neha. A. Waghade	7249895144	nehawaghade16082000@gmail.com	<u>N. Waghade.</u>
26)	Damini M. Bandbuche	8275105785	bandbuchedamini@gmail.com	<u>D. Bandbuche.</u>



DHARAMPETH M. P. DEO MEMORIAL SCIENCE COLLEGE, NAGPUR
INTERNAL QUALITY ASSURANCE CELL (IQAC)
NEP Activity Report

Date: 4/10/2022

Name of Organizing Department or Committee: Chemistry

Name of the activity: NEP Activity (SEM III -PAPER-I-UNIT-I)

Suggested CRITERION point if any: Criteria -II

Date of Activity: 27/09/2022

Place of Activity: Chemistry Department-

Name of Guest Speaker/s or Judge/s or Chief Guest/s if any- Nil

Title of the Activity: Model making of different molecules, Poster of MO diagram

Number of Participants: 30

Name of the Teacher In-charge / Convener -Dr.Mrs. Mrudul R. Keskar

Names of other Committee Members / Staff:- Dr. V.P. Meshram

OUTCOME of the Activity with respect to mission vision of the institute and or academics:

This is a student's centric activity. Students can visually understand the structure and properties of molecules more clearly. Students came to know about the diamagnetic and paramagnetic nature of molecules. This model visually clears the concept of students about different molecules.

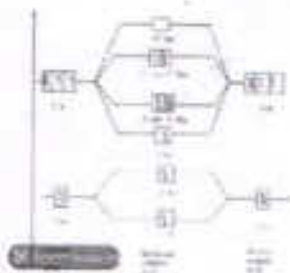

Activity with newspaper coverage if any : Nil

Activity data save in PC of: Department of Chemistry

Note: Kindly share geotag photographs separately along with report on igacdsc2022@gmail.com

Prof. Pitambar Humane
IQAC Coordinator

CO ORDINATOR
INTERNAL QUALITY ASSURANCE CELL
DHARAMPETH, M. P. DEO MEMORIAL &
SCIENCE COLLEGE, NAGPUR

J. Keskar
Name & Signature of Teacher In-charge
(Dr. Mrs. Mrudul R. Keskar)

Dr. Akhilesh Peshwe
Principal
PRINCIPAL

Dharampeth M.P. Deo Memorial
Science College, Nagpur-440033



DHARAMPETH M. P. DEO MEMORIAL SCIENCE COLLEGE,
North Ambazari Road, Near Ambazari Lake, Nagpur- 440033

DATA VALIDATION & VERIFICATION (DVV)

Name of the Programme : NEP Activity (Model making of different molecules and poster of 10 diagrams)
(Sem III, paper I, unit I) ✓
Date of the Programme : 27-09-2022
Name of Chief Guest if any : _____
Name of Guest Speaker if any : _____

Sr. No.	Name of the Participant	Mobile Number	E-mail Id	Signature
1.	Shreya Dhalwale	8669777890	sdhalwale@gmail.com	
2.	Rupesh Bhatore	9734578901	rupeshbhatore@gmail.com	
3.	Vaishnavi R. Hanpure	8124576891	vaishnavi36@gmail.com	
4.	Pooja Zankar	9213457891	pooja1@gmail.com	
5.	Chakul Madhkar	9115117117	chakulmadhkar@gmail.com	
6.	Manvi Raut	8121457890	manvi36@gmail.com	
7.	Dhanashree Nawalkar	9024578911	dhannawalkar@gmail.com	
8.	Tejas Rewade	9244458781	tejasrewade@gmail.com	
9.	Rohit Parate	8134576591	rohitparate@gmail.com	
10.	Susbhi Paudhe	7784567891	susbhipaudhe@gmail.com	

Signature of:

Programme In-charge

IQAC Coordinator
CO ORDINATOR
INTERNAL QUALITY ASSURANCE CELL
DHARAMPETH, M. P. DEO MEMORIAL &
SCIENCE COLLEGE, NAGPUR

Principal
PRINCIPAL
Dharampeth M.P. Deo Memorial
Science College, Nagpur-440033



DHARAMPETH M. P. DEO MEMORIAL SCIENCE COLLEGE,
North Ambazari Road, Near Ambazari Lake, Nagpur-440033

DATA VALIDATION & VERIFICATION (DVV)

11	Jyoti J. Sharma	8669736380	jyotis8390@gmail.com	J. Sharma
12	Nupur M. Sharma	9322012259	nupursharma253@gmail.com	At new
13	Sania A. Raje	8975726700	midhatania@gmail.com	alov
14	Nikita T. Kalle	9061324988	kallonikita54@gmail.com	Skallo
15	Jasraj D. Patilwal	9370820325	jasrajpatilwal47@gmail.com	Jasraj
16	Pranjwal S. Bhayar	800434634	Pranjwalb738@gmail.com	P.
17	AMAN ANIL DONGRE	7709217312	amandongre@gmail.com	amangre
18	Kalpna D. Sahagpure	9579236712	kalpanabukharypurat@gmail.com	Kalpna
19	Siddhanta C. Chakare	9579092931	siddhanta5101@gmail.com	Siddhanta
20	Juhi S. Chaudhari	8669248944	chaudharijuhi20@gmail.com	Juhi
21	Sakshi S. Meshram	9145855433	sakshimeshram210@gmail.com	Sakshi
22	Kajal P. Niphot	9373250629	kajalniphot2000@gmail.com	Kajal
23	Mansi I. Mate	8468891807	mansi19782@gmail.com	Mansi
24	Tina M. Bahangchale	9321776769	tinabahangchale@gmail.com	Tina
25	Valshnali R. Lakhe	8669594864	Chhakuli.lakhe536@gmail.com	Chhakuli
26	Vamila V. Bhandre	9370673867	bhandrevamila.com@gmail.com	Vamila
27	Shravya Dhawale	8888264004	shravyadhawale124@gmail.com	Shravya
28	Chhakuli C. Wadikar	9325047907	Chhakuliwadikar@gmail.com	Chhakuli Wadikar
29	Vaibhavi Shende	8080640282	vaibhavishende93@gmail.com	V.A. Shende
30	Gargi L. Nadge	797207667	garginadge@gmail.com	Gargi

Signature of Programme In-charge

COORDINATOR
INTERNAL QUALITY ASSURANCE CELL
DHARAMPETH, M. P. DEO MEMORIAL &
SCIENCE COLLEGE, NAGPUR

Principal
PRINCIPAL
Dharampeth M.P. Deo Memorial
Science College, Nagpur-440033



DHARAMPETH M. P. DEO MEMORIAL SCIENCE COLLEGE, NAGPUR
INTERNAL QUALITY ASSURANCE CELL (IQAC)

Activity Report

Date: 30/8/22

Name of Organizing Department or Committee: Zoology

Name of the activity: Installation of Zoological society guest lecture

Suggested CRITERION point if any: Criteria II

Date of Activity: 28/09/2022

Place of Activity: Late Vinayakrao Pathak Hall

Name of Guest Speaker judge/s or Chief Guest/s if any: Dr Archana Masram

Title of the Activity: Guest lecture on Vaccine

Number of Participants: 84

Name of the Teacher In-charge / Convener: Dr. K. M. Paturkar

Names of other Committee Members / Staff: Dr. K. M. Paturkar students of Zoological Society

OUTCOME of the Activity with respect to mission vision of the institute and or academics:

Student develops leadership quality by working as a member of zoological society.

It increases students involvement in the activities and helps to develops organizing capacity.

Students get detail knowledge of vaccines.

Students get information about variety of vaccines used during pandemic its advantages and disadvantages.

It helps in clearing doubts and misunderstanding regarding vaccines.

Activity with newspaper coverage if any: NIL

Activity data save in PC of: Zoology Department/personal laptop



Prof. Pitambar Humane

Dr. Kirti Paturkar

Name & Signature of Teacher In-charge

Dr. Akhilesh Peshwe

Principal

Dharampeth M. P. Deo Memorial
Science College, NAGPUR

INTERNAL QUALITY ASSURANCE CELL
DHARAMPETH, M. P. DEO MEMORIAL &
SCIENCE COLLEGE, NAGPUR



DHARAMPETH M. P. DEO MEMORIAL SCIENCE COLLEGE,
North Ambazari Road, Near Ambazari Lake, Nagpur- 440033

DATA VALIDATION & VERIFICATION (DVV)

Name of the Programme : Zoological Society Inauguration.
Date of the Programme : 28/9/22
Name of Chief Guest if any : Dr. Archana Masram
Name of Guest Speaker if any : Dr. Archana Masram.

Sr. No.	Name of the Participant	Mobile Number	E-mail Id	Signature
1.	Shruti Pawar	9527988707	shrutipawar0707@gmail.com	
2.	Tisha Kature	9021541048	tishakature@gmail.com	
3.	Aishwarya Jashi	9498328662	aishwarya.jashi203@gmail.com	
4.	Sayali Pandharpande	8208121810	Sayali.p0459@gmail.com	
5.	Nandini Hadge	9370301679	nandinihadge17@gmail.com	
6.	Bhargavi Sambare	7709403806	bhargavisambare05@gmail.com	
7.	Ishika Thakre	8010907069	ishithakre22@gmail.com	
8.	Laxmi Garte	7758058514	laxmigarde2908@gmail.com	
9.	Tarunay Chaudhary			
10.	M. Vaishnavi Gadge	9022976449	gadgavalshnavi00@gmail.com	
11.	Gargi Hadge	7972076671	gargihadge@gmail.com	
12.	Hanshad Warte			
13.	Pranjwal Bhoyar	8010434634	Pranjwal6738@gmail.com	
14.				

Signature of:
Programme In-charge

IQAC Coordinator
IQAC Co-ordinator

Dharampeth M.P. Deo Memorial
Science College, Nagpur-440033

Principal
Dharampeth M.P. Deo Memorial
Science College, Nagpur.



DHARAMPETH M. P. DEO MEMORIAL SCIENCE COLLEGE,
North Ambazari Road, Near Ambazari Lake, Nagpur- 440033

DATA VALIDATION & VERIFICATION (DVV)

Sr. No.	Name of the Participant	Mobile Number	E-mail Id	Signature
15	Ashalesha Khadgi	8830414264	kupalikhadgi@gmail.com	Ashalesha.K
16	Sunaina Chichonde	8530970132	Sunainachichonde@gmail.com	Sunaina
17	Vedant Baxu	8530155798	vedantbaxu2002@gmail.com	Vedant
18	pratiksha Meshram	8459070338	meshrampratiksha14@gmail.com	pratiksha
19	pranali Y. Chauhan	9699654562	pranalichauhan69@gmail.com	Pranali
20	Nikita S. Bhatpatre	7058625053	prachibhatpatre005@gmail.com	Bhatpatre
21	Jagruati A. Rawat	9265818046	Jagruati Jagit Rawat 58@gmail.com	Rawat
22	Muskan R. Yadav	9579492617	maskanyadav1225@gmail.com	Muskan
23	Muunalini S. Ramteke	9146003783	muunaliramteke0828@gmail.com	Ramteke
24	Gurjan J. Bhojrao	7666799586	gurjathbhojrao04@gmail.com	Gurjan
25	Pritya B. Sharma (14 year)	8010764549	pritya19012004sharma@gmail.com	Pritya
26	Maheshwari C. Alekar	8767940715	maheshwari.2021ea@gmail.com	Alekar
27	Darshana S. Madavi	8830148516	Darshnamadavi@gmail.com	Darshana
28	Jyoti J. Sharma	8859736380	jyoti8390@gmail.com	J.Sharma
29	Sumit Bhande	7776009180	Sumitbhande100@gmail.com	Sumit
30	Juhi Chaudhari	8669248944	chaudharijuhi120@gmail.com	Juhi
31	Sakshi Meshram	9145355733	sakshimeshram210@gmail.com	Sakshi
32	Jagruati Wankar	7447366023	jagruatiwankar09@gmail.com	Jagruati

Signature of: 
Programme In-charge

IQAC Co-ordinator
Dharampeth M.P. Deo Memorial
Science College, Nagpur-440033

Principal
Dharampeth M.P. Deo Memorial
Science College, Nagpur.



DHARAMPETH M. P. DEO MEMORIAL SCIENCE COLLEGE,
North Ambazari Road, Near Ambazari Lake, Nagpur- 440033

DATA VALIDATION & VERIFICATION (DVV)

Sr. No.	Name of the Participant	Mobile Number	E-mail Id	Signature
33.	Mansi Mate	8468891807	mansimate19182@gmail.com	
34.	Jeet Pardhi	7070215431	jeetspardhi111@gmail.com	
35.	Somyak Hadke	7020171304	somyakhadke30@gmail.com	
36.	Kiran K. Ghugkhar	9823710569	ghugkhar.kiran2004@gmail.com	
37.	Sejal Kolhe	8483045985	KolheSejal04@gmail.com	
38.	Stidhi Tiwari	8087143696	stidhitiwari0721@gmail.com	
39.	Umang Wauthi	9322428500	Umangwauthi@gmail.com	
40.	Sanket Lode	7972085380	Sanketlode123@gmail.com	
41.	Suraj Jadao	8767435158	SurajJhyanjalaw82@gmail.com	
42.	Samiksha Khobragade	9156906097	Khobragadesamiksha381@gmail.com	
43.	Devanshi Do Bisen	7767861231	Devanshibisen31@gmail.com	
44.	Anjali Anil Mishra	9305604513	anjalmishra4956@gmail.com	
45.	Rohit A. Pawate	9373097285	KateateRohit9@gmail.com	
46.	Premchand Wairagade	8261836557	Premchandwairagade@gmail.com	

Signature of:
Programme In-Charge

IOAC Coordinator
Dharampeth M.P. Deo Memorial
Science College, Nagpur-440033

Principal
Dharampeth M.P. Deo Memorial
Science College, Nagpur.



DHARAMPETH M. P. DEO MEMORIAL SCIENCE COLLEGE,
North Ambazari Road, Near Ambazari Lake, Nagpur- 440033
DATA VALIDATION & VERIFICATION (DVV)

Sr. No.	Name of the Participant	Mobile Number	E-mail Id	Signature
1	Devashri D. Bisen	8698119078	DKB@DKBisen74@gmail.com	
2	Siddhant G. Hiskane	9579092931	hiskanesiddhant1234@gmail.com	
3	Khushbu H. Choudhary	7262074960	khushbucthary38@gmail.com	
4	Sagar S. Bawane	9975460979	sagarbawane637@gmail.com	
5	Chirayu B Dolas	8010135012	chirayudolas22@gmail.com	
6	Vaibhav A. Malewar	8767838219	vaibhavmalewar96@gmail.com	
7	Aakansha mairal	8010923662	aakanshayogi2004@gmail.com	
8	Khushi Rewade	9588445994	khushirewade@gmail.com	
9	Geeta Bhojare	8668335876	geetabhojare34@gmail.com	
10	Dhanashri neware	9359907913	dhanashrineware@gmail.com	
11	Pooja Bisen	8483097439	Poojabisen254@gmail.com	
12	Surabhi R. Parde	7887516628	surabhiparde@gmail.com	
13	Tina G. Rahangdale	9921776769	tinarahangdale@gmail.com	
14	Chhakuli G. Wadikar	9325047907	chhakuwadikar13@gmail.com	
15	Varshma V. R. Lakhe	8669584864	chhakuwadikar13@gmail.com	
16	Mansi D Raut	7385114931	Mansiraut651@gmail.com	
17	Nilash Hulke	8624090652	Hulkenilash@gmail.com	
18	Twinkal Lokhande	8149176609	TwinkalLokhandeK@gmail.com	

Signature of:
Programme In-charge

IQAC Co-ordinator
Dharampeth M.P. Deo Memorial
Nagpur-440033

Principal
Dharampeth M.P. Deo Memorial
Science College, Nagpur

19) Vaishnavi Nandpute	932239316	vaishnavinandpute8@gmail.com	<u>Nandpute</u>
20) Pooja Itankar	9156973252	poojaitankar987@gmail.com	Itankar
21) Niket Thakre	7378899087	thakreniket@gmail.com	<u>N</u>
22) Rupesh Bhokre	8805887370	rupeshbhokre@gmail.com	Rupesh
23) Abhishek Deshbhretae	8208302902	abhishekdeshbhretae8862@gmail.com	<u>Abhishek</u>
24) Kalpana Suhagpura	9579236712	kalpanasuhagpura@gmail.com	Suhagpura
25) Shrawani Wankhede	8806636133	shrawaniwankhede1@gmail.com	<u>Shrawani</u>
26) Shrutika Channekar	9699323842	shrutichannekar700@gmail.com	<u>Shrawanekar</u>
27) Anjali Mishra	9225604513		
28) Rohit Patte			
29) Vaishali Patte	9322600647	vaishalipatte@gmail.com	<u>Patte</u>
30) Shikha Yadav	9569714465	shikhayadav@gmail.com	<u>Shikha</u>
31) Subbu Mishra	9860486419	subbumisha@gmail.com	<u>Subbu</u>
32) Sushma Guenule	9156238747	sushmaguenule12@gmail.com	<u>Guenule</u>
33) Yashastri Chaudhary	7220995622	yashastrichaudhary@gmail.com	<u>Y. Chaudhary</u>
34) Shrutika Mishra	8308657972	shrutimishra@gmail.com	<u>Mishra</u>
35) Varshika Yede	7558244609	varshikayede1@gmail.com	<u>Varshika</u>
36) Saniya Naik	9370570657	saniyanaik1@gmail.com	<u>Naik</u>
37) Samiksha Chamate	7709204933	chamatksakshiz4@gmail.com	<u>Chamate</u>
38) Vishakha Bansod	8999782361	bansodvishakha221@gmail.com	<u>Vishakha</u>



DHARAMPETH M. P. DEO MEMORIAL SCIENCE COLLEGE, NAGPUR

INTERNAL QUALITY ASSURANCE CELL (IQAC)

Activity Report

Date: 28/09/2022

Name of Organizing Department or Committee: Department of Physics
Name of the activity: NEP based Demonstration Activity for B.Sc. Semester III (Paper I)
Suggested CRITERION point if any: Restricted to RTMNU B.Sc. physics syllabus.
Date of Activity: 28/09/2022
Place of Activity: Room no. 004
Name of Guest Speaker/s or Judge/s or Chief Guest/s if any: NA
Title of the Activity: Demonstration of audibility of Human ear
Activity with newspaper coverage if any: No
Number of Participants: B.Sc. Semester III Students - 51
Name of the Teacher In-charge / Convener: Dr. Nayana Sonwane
Names of other Committee Members / Staff: N.A.

OUTCOME of the Activity with respect to academics:

This activity is based on the identification of sound frequencies that are audible to the human ear. For this the "Sound Generator" app was installed in the mobile. The students experienced the low and high frequency sound through this app and found that the frequencies lying between 100 Hz to 20 KHz are audible to human ear and the rest of the range of frequencies cannot be heard through human ear. Meanwhile the human audibility mechanism was also discussed.

DVV: Enclosed.

Activity data save in PC of: Lt. Dr. P. W. Ambekar

Prof. Pitambar Humane
IQAC Coordinator

CO ORDINATOR
INTERNAL QUALITY ASSURANCE CELL
DHARAMPETH, M. P. DEO MEMORIAL
SCIENCE COLLEGE, NAGPUR

Name & Signature of Teacher In-Charge
Dharampeth M. P. Deo Memorial
Science College, Nagpur

Dr. Akhilesh Peshwe
Principal

Principal
Dharampeth M.P. Deo Memorial
Science College, Nagpur.



DHARAMPETH M. P. DEO MEMORIAL SCIENCE COLLEGE NAGPUR

Department of Physics

Class: B.Sc. Sem.- III

NEP ACTIVITY

Paper-1

Unit-3

Name of the Teacher: Dr. N. Sawane

Date: 28/09/22

Title of Activity: Demonstration of audibility of human ear

Sr. No.	Name of Student	Batch	Mobile No.	Email ID	Signature
1	Shruti Ramteke	S-9	8857031895	shruti981@gmail.com	<u>Shruti</u>
2	Kajal Nighat	S-8	9373250623	kajalnighat2000@gmail.com	<u>Kajal</u>
3	Kajal Jilakharani Prasad	S-8	7410763138	prasadkajal2004@gmail.com	<u>Kajal</u>
4	Mansi Ashok Budale	S-8	7796908487	mansiabudale@gmail.com	<u>Budale</u>
5	Jasraj Devital Patil	S-8	9370820225	jasrajpatil192@gmail.com	<u>J. Patil</u>
6	Atharva P. Umate	S-5	9294641511	atharvumate@gmail.com	<u>P. Umate</u>
7	Atharva Vinod Ingule	S-7	9022468636	atharvavngule27@gmail.com	<u>A. Ingule</u>
8	Ayush R. Basilran	S-5	9579445072	ayushbasilran45@gmail.com	<u>Ayush</u>
9	Prityanka S. Shah	S-3	7385197365	ps3347311@gmail.com	<u>Prityanka</u>
10	Aasim K. Sheikh	S-3	8668323588	aasimns029@gmail.com	<u>A. Sheikh</u>
11	Mansi Sham Fatimg	S-8	8767134686	mansifatimg2110@gmail.com	<u>Mansi</u>
12	Ritul K. Bisen	S-5	70028910840	ritulbisen26@gmail.com	<u>R. Bisen</u>
13	Shweta Bedwal	S-5	5050450194	shwetabedwal2605@gmail.com	<u>Shweta</u>
14	Anuj Mishra	S-5	8103656208	anujmishra25102@gmail.com	<u>Anuj</u>
15	Simran Tarmare	S-10	7972530338	simrantarmare@gmail.com	<u>Simran</u>
16	Sakshi Ingle	S-9	9067877894	inglesakshi703@gmail.com	<u>Sakshi</u>
17	Sanhita Patil	S-5	7218079074	sanhitapatil2003@gmail.com	<u>S. Patil</u>
18	Damini Katre	S-5	8208255685	daminikatred@gmail.com	<u>Damini</u>
19	Nitin Krushwaha	S-5	9693429005	nitinkrushwaha70@gmail.com	<u>Nitin</u>
20	Aditya K. Shukla	S-5	9518594638	adityashukla0202@gmail.com	<u>Aditya</u>
21	Aditi Lute	S-5	7820812303	aditilute161@gmail.com	<u>Aditi</u>
22	Nutan Suresh	S-5	8805570279	nutansuresh2@gmail.com	<u>Nutan</u>
23	Bhagyashree Thakore	S-5	8766925275	thalbhagyashree@gmail.com	<u>Bhagyashree</u>
24	Divya Kailash Hanote	S-8	8605422901	divyahanote0406@gmail.com	<u>Divya</u>
25	Nupur Sharma	S-8	9322042269	nupursharma269@gmail.com	<u>Nupur</u>
26	Prachit R. Kotralikar	S-9	7498102097	prachitkotralikar@gmail.com	<u>Prachit</u>

Signature of Teacher

Head of Department

27)	Prakhar R. Buradkar	S-3	8329760853	Prakhar.Buradkar@gmail.com	Buradkar
28)	Kunal Digrahe	S-5	9010276303	kunaldigrahe@gmail.com	Kunal
29)	Ananya R. Nalgave	S-7	729218958	ananya.nalgave@gmail.com	Ananya
30)	Apurva S. Verutkar	S-7	9623613911	apurva.verutkar@gmail.com	Apar
31)	Komal. Patle	S-8	9887708100	Komalpatle234@gmail.com	Komal
32)	Chetan Bopche	S-3	9172484628	chetanbopche27@gmail.com	Chetan
33)	Vrushali Shahare	S-1	9307516332	Vrushalishahare2@gmail.com	Vrushali
34)	Bhumnika V. Thakre	S-7	7218247917	Bhumnika.thakre55@gmail.com	Bhumnika
35)	Rushali D. Bhoskar	S-9	9579485597	bhoskar.rushali@gmail.com	Rushali
36)	Dharmapreeti Lalo	S-7	9975037356	dharmapreetilalaj@gmail.com	Dharmapreeti
37)	Snehanadi Dharm	S-10	7420880982	Snehanadidharm31@gmail.com	Snehanadi
38)	Ashmit Juvon	S-7	8080235161	ashmitjuvon@gmail.com	Ashmit
39)	Om Kumar. Devrajam	S-9	9763624358	ommumaji12@gmail.com	Om Kumar
40)	AKSHAY KHANDARE	S-5	7350956809	akshaykhandare73@gmail.com	Akshay
41)	Hitesh B. Kamare	S-5	7051027112	hiteshkamare73@gmail.com	Hitesh
42)	Kamini C. Kishore	S-7	9067445211	Kamini.anuradhaishikha1010@gmail.com	Kamini
43)	Aditya Kumar Singh	S-5	7350543901	adityasingh1288180@gmail.com	Aditya
44)	Pinteh Parthi	S-7	9623389676	parthipinteh31@gmail.com	Pinteh
45)	Pratik Lilhare	S-9	9307480168	Pratiklilhare3@gmail.com	Pratik
46)	Mithilesh Prasad	S-8	7558719539	pmithilesh345@gmail.com	Mithilesh
47)	Ayaz M. Sheikh	S-7	8767355503	ayaz59068@gmail.com	Ayaz
48)	Rohit S. Wanjari	S-9	7741061307	wanjarirohit1@gmail.com	Rohit
49)	Pratik D. Lilhare	S-9	9307480168	Pratiklilhare3@gmail.com	Pratik
50)	Vaishali S. Nimje	S-9	9579993869	vaishalinimje2003@gmail.com	Vaishali
51)	Vatam S. Sonwane	S-9	9975410765	vatamsouwane@gmail.com	Vatam

 HEAD
 DEPARTMENT OF PHYSICS
 Chhatrapati M. P. Deo Memorial
 Bolnisi College, Nagpur



Activity Report

Date: 30/09/22

Name of Organizing Department or Committee: Chemistry Department

Name of the activity: NEP Activity Report (Sem- I, Unit-II)

Suggested CRITERION point if any: Criteria II

Date of Activity: 28/09/22

Place of Activity: Chemistry Department Laboratory

Name of Guest Speaker/s or Judge/s or Chief Guest/s if any: Nil

Title of the Activity: Collection of Different Salts sampling

Number of Participants: 30

Name of the Teacher In-charge / Convener: Dr. Pranita Gawande, Niharika Sute

Names of other Committee Members / Staff: Dr. Vaishali Meshram

OUTCOME of the Activity with respect to mission vision of the institute and or academics:

This is student centric activity. By the collection of salts, students come to know that there are different types of salts which are categorised according to their colour, nature and physical properties.

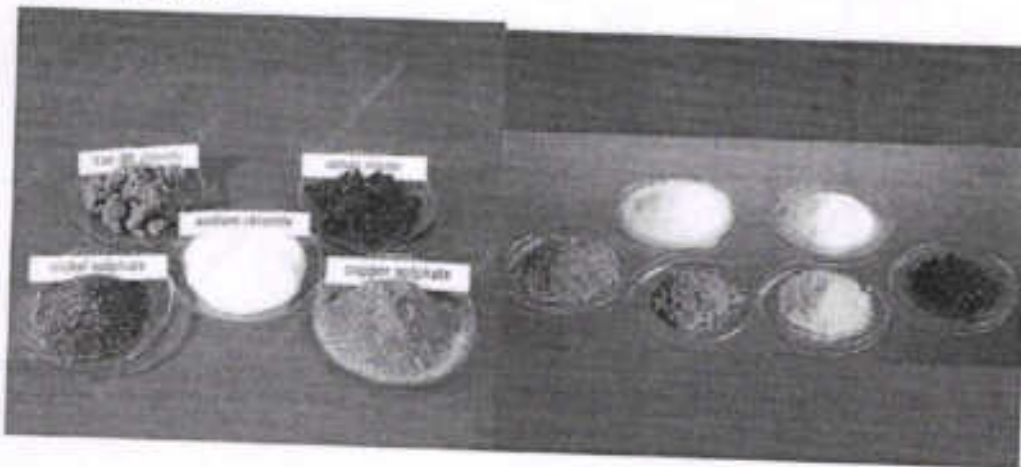

Activity with newspaper coverage if any: Nil

Activity data save in PC of: Chemistry Department

Note: Kindly share geotag photographs separately along with report on iqacdsc2022@gmail.com

Prof. Pitambar Humane
IQAC Coordinator

CO ORDINATOR
INTERNAL QUALITY ASSURANCE CELL
DHARAMPETH, M. P. DEO MEMORIAL &
SCIENCE COLLEGE, NAGPUR

Name & Signature of Teacher In-charge

Dr. Pranita Gawande

Dr. Akhilesh Peshwe
Principal

PRINCIPAL
Dharampeth M.P. Deo Memorial
Science College, Nagpur-440024



DHARAMPETH M. P. DEO MEMORIAL SCIENCE COLLEGE,
North Ambazari Road, Near Ambazari Lake, Nagpur- 440033

DATA VALIDATION & VERIFICATION (DVV)

NEP Activity-2 on Unit-II (Sem-I)

Name of the Programme : Collection of Different Salts Sampling
Date of the Programme : 28/09/22
Name of Chief Guest if any : _____
Name of Guest Speaker if any : _____

Sr. No.	Name of the Participant	Mobile Number	E-mail Id	Signature
1.	Shital Patil	9764596337	shital.palle@gmail.com	Shital
2.	Ritika Bhojraj	9834587087	ritikabhoyar2a@gmail.com	Ritika
3.	Monika Patel	7499225468	Monika.Patel1a58@gmail.com	Monika
4.	Saurabh Chaudhary	9359883501	Schaudhary5599@gmail.com	Shau
5.	Ruchi Chivredli	8080776893	Ruchi.chivredli230@gmail.com	Ruchi
6.	Aakansha Maizal	8010923662	clark4gogi2004@gmail.com	Am
7.	Durgesh Ghodmare	9075318618	durgesh.ghodmare001@gmail.com	Durgesh
8.	Karishma Prasad	9309318682	narendra.prasad72@gmail.com	KP
9.	Pawan Thakre	8262969713	thakre.pawan739@gmail.com	P.Thakre
10.	Pratibha Bhuzari	7821068413	pbbhuzari718@gmail.com	Pratibha
11.	Shivam Patel	7038889083	SP040263@gmail.com	Patel
12.	Ankit Patel	9970905632	ankit.patel797275@gmail.com	Ankit
13.	Shreyas Sha	8983236002	sangeetash30@gmail.com	Shreyas
14.	Arjun Sharma	7020107398	arjun7010sharma@gmail.com	Arjun

Signature of:
Programme In-charge

IQAC Coordinator
CO ORDINATOR
INTERNAL QUALITY ASSURANCE CELL
DHARAMPETH, M. P. DEO MEMORIAL &
SCIENCE COLLEGE, NAGPUR

Principal
PRINCIPAL
Dharampeth M.P. Deo Memorial
Science College, Nagpur-440033



DHARAMPETH M. P. DEO MEMORIAL SCIENCE COLLEGE,
North Ambazari Road, Near Ambazari Lake, Nagpur-440033

DATA VALIDATION & VERIFICATION (DVV)

15	yogita Ramesh Denge	7058437240	yogitadenge@gmail.com	YD Denge
26	Maheshwari Mahendra Bhole	9022137975	maheshwari1bhole@gmail.com	Maheshwari
17	Apeksha. Digambar Kotagal	9559455994	apekshakakotagal26@gmail.com	Apeksha Kotagal
18	poiya R. Dubey	8669495362	dubeyramshpaty@gmail.com	Apeksha
19	Shital. M. Patle.	9764596337	SP@gmail.com	Shital
20	Ritika. R Bhoyar	9894587087	ritikalalbhoyar28@gmail.com	Chetal Patle
21	pratibha. B Ghusari	9821048413	pratibha08ghusari2@gmail.com	B. Kulkarni
22	monika J Patil	7499225468	monikapatil9038@gmail.com	M. Patil
23	Sejal. D Kolhe	8483045985	kolhesejal04@gmail.com	Sejal Kolhe
24	Aparna Mahabe	7020649887	Aparnomah4023@gmail.com	A. Mahabe
25	Ashwini Narote	8275566422	AshwiniNarote123@gmail.com	A. Narote
26	Shivam Patel	7038889083	sp040263@gmail.com	Ashwini Narote
27	Aniket. Kumbhe	8262817299	aniketkumbhe@gmail.com	Aniket
28	Roy N. Mehta	9529927031	roynmesha0140@gmail.com	Roy Mehta
29	AARON SHARMA	7020107398	aaron7010sharma@gmail.com	Aaron Sharma
30	Shreya. A Jha.	8983236002	shreetajha0303@gmail.com	S. Jha

Signature of:
Programme In-charge

Signature of:
CO ORDINATOR
INTERNAL QUALITY ASSURANCE CELL
DHARAMPETH, M. P. DEO MEMORIAL &
SCIENCE COLLEGE, NAGPUR

Signature of:
PRINCIPAL
Dharampeth M.P. Deo Memorial
Science College, Nagpur-440033



DHARAMPETH M. P. DEO MEMORIAL SCIENCE COLLEGE, NAGPUR
INTERNAL QUALITY ASSURANCE CELL (IQAC)

NEP Activity Report

Date: -4 /10 / 2022

Name of Organizing Department or Committee - Chemistry

Name of the activity: NEP Activity (SEM III -PAPER-2-UNIT-1)

Suggested CRITERION point if any: Criterion -II

Date of Activity: 28/09/2022

Place of Activity: Chemistry Department

Name of Guest Speaker/s or Judge/s or Chief Guest/s if any: - Nil

Title of the Activity: Chemical used in DDT and BHC and its toxicity and uses - Benzene

"Comparision of colour & odour of benzene and its derivatives Nitrobenzene, Aniline, Phenol "

Number of Participants: 57

Name of the Teacher In-charge / Convener - Dr. Tanishq Chaudhari

Names of other Committee Members / Staff - Dr. V.P. Meshram

OUTCOME of the Activity with respect to mission vision of the institute and or academics:

Students are able to compare the i) peculiar colour of Nitrophenol-yellow & peculiar odour of bitter almond, ii) colourless to pink Phenol having disinfectant Phenyl type odour. iii) Brown oily appearance of Aniline having musty fishy odour.

Activity with newspaper coverage if any: Nil

Activity data save in PC of -Chemistry Department

Note: Kindly share geotag photographs separately along with report on igacdsc2022@gmail.com



Prof. Pitambar Humane

COORDINATOR
INTERNAL QUALITY ASSURANCE CELL
DHARAMPETH, M. P. DEO MEMORIAL &
SCIENCE COLLEGE, NAGPUR

Name & Signature of Teacher In-charge
(Dr. T. Chaudhari)

Dr. Akhilesh Peshwe
Principal

PRINCIPAL
Dharampeth M.P. Deo Memorial
Science College, Nagpur-440033

28/09/2022



DHARAMPETH M. P. DEO MEMORIAL SCIENCE COLLEGE,
North Ambazari Road, Near Ambazari Lake, Nagpur- 440033

DATA VALIDATION & VERIFICATION (DVV)

Name of the Programme : Activity-I Sem-3 ; Comparison of colour & odour of benzene and its derivatives - Nitrobenzene, Phenol, Aniline

Date of the Programme : Benzene → used in BHC ; its toxicity and uses.

Name of Chief Guest if any : _____

Name of Guest Speaker if any : _____

Sr. No.	Name of the Participant	Mobile Number	E-mail Id	Signature
1	Jasraj Paliwal	9870820325	jasrajpaliwal47@gmail.com	Jasraj
2	Sagar S. Bawane	9975460979	sagarbawane637@gmail.com	S.Bawane
3	Chirayu B. Dolas	8010135012	chirayudolas22@gmail.com	C.B.Dolas
4	Vaishnavi T. Kapse	8983751089	Vaishnavikapse05@gmail.com	Vaishnavi
5	Shital G. Bankat	7758055139	Shitalbankat122@gmail.com	S.G.Bankat
6	Shrutika R. Boskar	9067950845	shrutika01@gmail.com	S.Boskar
7	Vaishu S. Nimje	9579993869	vaishunimje2003@gmail.com	V.Nimje
8	Uamila V. Bondre	9370673867	bondreUamila.2000@gmail.com	U.Bondre
9	Shreya S. Dhawale	8888264004	shreya.dhawale124@gmail.com	Shreya
10	Vaibhavi A. Shinde	8080640782	vaibhavisshinde37@gmail.com	V.A.Shinde

Signature of:

Programme In-charge

IQAC Coordinator

CO ORDINATOR

INTERNAL QUALITY ASSURANCE CELL
DHARAMPETH, M. P. DEO MEMORIAL &
SCIENCE COLLEGE, NAGPUR

Principal

PRINCIPAL

Dharampeth M. P. Deo Memorial
Science College, Nagpur-440033

Activity on Unit-1



DHARAMPETH M. P. DEO MEMORIAL SCIENCE COLLEGE,
North Ambazari Road, Near Ambazari Lake, Nagpur- 440033

DATA VALIDATION & VERIFICATION (DVV)

Name of the Programme : _____
Date of the Programme : _____
Name of Chief Guest if any : _____
Name of Guest Speaker if any : _____

Sr. No.	Name of the Participant	Mobile Number	E-mail Id	Signature
11	Bhumika ulas thakre	7218247917	bhumika.thakre55@gmail.com	
12	Apurva Venulkar	9623613911	apurva.venulkar@gmail.com	
13	Samir Ghumde	9359236713	Sameerghum2002@gmail.com	
14	Aniket Kulkade	7709629106		
15	Jyoti Sharma	8669736380	jyotis8390@gmail.com	
16	Sumit Bandeduche	7776009180	sumitbandeduche100@gmail.com	
17	Rutik V. Gajbhiye	7620826960	rutikgajbhiye05@gmail.com	
18	Ritik M. Varma	9356744234	ritikv929@gmail.com	
19	Rushikesh B. Hambarde	9028225874	rushikeshhambarde978@gmail.com	
20	Ketaki R. Karpal	9112799066	ketakikarpal13@gmail.com	

Signature of:

Programme In-charge

CO-ORDINATOR
IQAC Coordinator
INTERNAL QUALITY ASSURANCE CELL
DHARAMPETH, M. P. DEO MEMORIAL &
SCIENCE COLLEGE, NAGPUR

PRINCIPAL
Dharampeth M.P. Deo Memorial
Science College, Nagpur-440033

Activity on Unit - 1



DHARAMPETH M. P. DEO MEMORIAL SCIENCE COLLEGE,
North Ambazari Road, Near Ambazari Lake, Nagpur- 440033

DATA VALIDATION & VERIFICATION (DVV)

21.	Gauri Anun Raut	9767873447	ankuraut2003@gmail.com	G.Raut
22.	Ajeena Rahim Sheikh	8080083981	ajeinashikh973@gmail.com	Sheikh
23.	Smriti Vaidya	8856908764	SmritiVaidya36@gmail.com	Vaidya
24.	Anustree Ghanshyam Chandel	9145631751	anuchandel2001@gmail.com	A.Chandel
25.	Vaishnavi Rajesh Lakhe	8669594864	chhaku.lakhe536@gmail.com	Lakhe
26.	Tina Gaikaran Rahangdale	9921776769	tinarahangdale@gmail.com	Rahangdale
27.	Rohit A. Pawate	9379097285	PawateRohit8@gmail.com	Pawate
28.	Siddhant Hirakane	9579092931	SiddhantHirakane@gmail.com	Siddhante
29.	Chhaku. Ganesh. Wadikar	9325047907	chhkuwadikar19@gmail.com	Wadikar
30.	Sureti Langadje	8390516517	SuretiLangadje11@gmail.com	Sureti
31.	Pratiksha Narghare	8623033760	NargharePratiksha@gmail.com	Pratiksha
32.	Vaibhav A. Malewar	8767828219	vaibhavamalewar79@gmail.com	Malewar
33.	Devesh S. Langadje	9326246453	deveshlangadje@gmail.com	Devesh
34.	Kalyani C. Shikare	9307046378	ShikareKalyani5@gmail.com	Shikare
35.	Vishakha D. Baswante	8329639834	VishakhaBaswante@gmail.com	Baswante

Signature of:

Tanush

Programme In-charge

CO ORDINATOR
INTERNAL QUALITY ASSURANCE CELL
DHARAMPETH, M. P. DEO MEMORIAL &
SCIENCE COLLEGE, NAGPUR

Principal
PRINCIPAL

Dharampeth M.P. Deo Memorial
Science College, Nagpur-440033

Activity on Unit - 1



DHARAMPETH M. P. DEO MEMORIAL SCIENCE COLLEGE,
North Ambazari Road, Near Ambazari Lake, Nagpur- 440033

DATA VALIDATION & VERIFICATION (DVV)

36)	Shital R. Ketzarkar	9673385046	shital2020kk@gmail.com @Ketzarkar
37)	Nikita Kallu	906732498P	kalluNikita54@gmail.com @Nikita
38)	Twinkal Lokhande	8149196609	twinkalokhande19@gmail.com. Twinkal
39	Mansi Raut	7385114937	Mansiraut451@gmail.com M
40)	Juhi Chaudhari	8669248944	juhi.chaudhari.juhi12@gmail.com Juhi
41	Sakshi Meshram	9145355789	sakshi.meshram.210@gmail.com. Sakshi
42	Mansi Mate	98468891807	mansi19182@gmail.com Mansi
43)	Pooja S. Itankar	9156973252	Poojaitankar987@gmail.com P
44)	Jagauti Dharamraj Wankar	7447366023	jagauti.wankar.99@gmail.com Jagauti
45)	Parshant Madani	8880146516	parshantm@gmail.com Parshant
46)	Ruchika Patle	8669335901	ruchikapatle4@gmail.com Ruchika
47)	Komal Patle	9881748506	komalpatle234@gmail.com Komal
48)	Swarandhi Dhare	7420880982	
49)	Riya Pandit	9370616353	Panditriya4753@gmail.com Riya
50)	Ashmit Juwar	8080238181	ashmitjuwar@gmail.com Ashmit

Signature of:

Tanishk

Programme In-charge

IQAC Coordinator

INTERNAL QUALITY ASSURANCE CELL
DHARAMPETH, M. P. DEO MEMORIAL &
SCIENCE COLLEGE, NAGPUR

Principal

PRINCIPAL

Dharampeth M.P. Deo Memorial
Science College, Nagpur-440033

Activity on Unit - I.



DHARAMPETH M. P. DEO MEMORIAL SCIENCE COLLEGE,
North Ambazari Road, Near Ambazari Lake, Nagpur- 440033

DATA VALIDATION & VERIFICATION (DVV)

51	Nilesh hulle	8624091652	hulle.nilesh@gmail.com	
52	Aryali Mishra	9325604513	aryalimishra01@gmail.com	Aryali
53	Vaishnavi Nandpura	9322439316	Vaishnavinandpura@gmail.com	
54	Shrawani Wankhede	705570 36883	shrawaniwankhede@gmail.com	Shrawani
55	Khushbu Chandhok	7262074960	khushbucchandhok98@gmail.com	
56	Siddhanta G. Miskane	9579092931	hiskane.siddhanta123@gmail.com	
57	Praywal S. Bhojane	8010434634	Praywalb723@gmail.com	

Signature of:

Programme In-charge

IQAC COORDINATOR
INTERNAL QUALITY ASSURANCE CELL
DHARAMPETH, M. P. DEO MEMORIAL &
SCIENCE COLLEGE, NAGPUR

Principal

PRINCIPAL
Dharampeth M.P. Deo Memorial
Science College, Nagpur-440033



DHARAMPETH M. P. DEO MEMORIAL SCIENCE COLLEGE, NAGPUR
DEPARTMENT OF COMPUTER SCIENCE
ACADEMIC SESSION: 2022-23

NOTICE

20th September 2022

All the students of B.Sc.[SEM V] are hereby informed that the Department of Computer Science, Dharampeth M.P.Deo Memorial Science College, Nagpur is going to organize Online Quiz Project Design activity base on Unit I of Paper I[Visual Basic Programming] on 29th September 2022. All the students must remain present and participate in this activity.

Venue : Computer Science laboratory
Time : 11.15am

PRINCIPAL
DHARAMPETH M. P. DEO
MEMORIAL SCIENCE COLLEGE
NAGPUR

Head, Department of Computer Science
Head,
Department of Computer Science
Dharampeth M. P. Deo Memorial
Science College, Nagpur



**DHARAMPETH M. P. DEO MEMORIAL SCIENCE COLLEGE, NAGPUR
INTERNAL QUALITY ASSURANCE CELL (IQAC)**

Activity Report

Date: 29th September 2022

Name of Organizing Department or Committee: Department of Computer Science

Name of the activity: Project Design

Suggested CRITERION point if any: Criteria II,V

Date of Activity: 29th September 2022

Place of Activity: Computer Science Laboratory

Name of Guest Speaker/s or Judge/s or Chief Guest/s if any: Dr. Mrs. Snehal Narale

Title of the Activity: Online Quiz Project Design using Visual Basic for the Students of B.Sc. Sem V on Unit I - Paper I [VBP]

Number of Participants: 30

Name of the Teacher In-charge / Convener: Dr. Mrs. Snehal Narale

Names of other Committee Members / Staff: Nil

OUTCOME of the Activity with respect to mission vision of the institute and or academics:

- The objective of this activity was to offer a platform to the students of final year to explore their ideas of the project and applying them using front end visual basic which is part of their syllabus.
- Students will be able to understand how to work successfully in groups and to learn how to work with others and complete their task..
- It helps them to know how to handle issues that arise in groups during the project designing and compilation. .
- To understand the practical importance of strong teamwork skills.
- Students will be able to know the respectfully listening to and considering opposing views or a minority opinion, effectively managing conflict around differences in ideas or approaches, keeping the group on track during and between the project designing and completion activity.

Activity with newspaper coverage if any: Nil

Activity data save in PC of: Dr. Mrs. Snehal Narale's Laptop



Prof. Pitambar Humane
IQAC Coordinator

IQAC Co-ordinator
Dharampeth M.P. Deo Memorial
Science College, Nagpur-440033

Dr. Mrs. Snehal Narale

Name & Signature of Teacher In-charge

Dr. Akhilesh Peshwe
Principal

Principal
Dharampeth M.P. Deo Memorial
Science College, Nagpur



DHARAMPETH M. P. DEO MEMORIAL SCIENCE COLLEGE,
North Ambazari Road, Near Ambazari Lake, Nagpur- 440033

DATA VALIDATION & VERIFICATION (DVV)

Name of the Programme : Project design [sem V] unit I Activity.
Date of the Programme : 29/9/2022
Name of Chief Guest if any : _____
Name of Guest Speaker if any : _____

Sr. No.	Name of the Participant	Mobile Number	E-mail Id	Signature
1. (1)	Akash Das - Group	7972942799	akashdas6@hotmail.in	Akash Das
(2)	Sanchit Joshi	8975706788	Sanchitjoshi02@gmail.com	Sanchit Joshi
(3)	Tanmay Gadam	7262034396	tanmaygadam1@gmail.com	T.S. Gadam
2.	Group: Atharva warries			
(4)	Safal Jaiswal	7219533166	Safaljaiswal45@gmail.com	Safal Jaiswal
(5)	Atharva Girhe	9404413055	atharvagirhe@gmail.com	Atharva
(6)	Ashwin Kumar	9172650720	ashwinmukumar@gmail.com	Ashwin
3.	GROUP: PKS			

Signature of:

Program In-charge
Head,
Department of Computer Science
Dharampeth M. P. Deo Memorial
Science College, Nagpur

IOAC Coordinator
CO ORDINATOR
INTERNAL QUALITY ASSURANCE CELL
DHARAMPETH, M. P. DEO MEMORIAL &
SCIENCE COLLEGE, NAGPUR

Principal
Principal
Dharampeth M.P. Deo Memorial
Science College, Nagpur.



DHARAMPETH M. P. DEO MEMORIAL SCIENCE COLLEGE,
North Ambazari Road, Near Ambazari Lake, Nagpur-440033

DATA VALIDATION & VERIFICATION (DVV)

(29) Seema M. Lakda	7058728070	seemalakda0730@gmail.com	Seema
(28) Pratibha. Chaudhari	750737699	Chaudharypratikha2002@gmail.com	Pratikha
(23) Bhavesh A. Maske	748995631	bhaveshmaske2002@gmail.com	B. Maske
(24) Mahesh P. Maske	9021951173	maheshmaske97@gmail.com	Mahesh
(30) Sani A. Bai	8855993509	saniwani11@gmail.com	Sani

Signature of:

Program In-charge

Department of Computer Science
Dharampeth M. P. Deo Memorial
Science College, Nagpur

IQAC Coordinator

NATIONAL QUALITY ASSURANCE CELL
DHARAMPETH M. P. DEO MEMORIAL
SCIENCE COLLEGE, NAGPUR

Principal

Dharampeth M.P. Deo Memorial
Science College, Nagpur.



DHARAMPETH M. P. DEO MEMORIAL SCIENCE COLLEGE,
North Ambazari Road, Near Ambazari Lake, Nagpur-440033

DATA VALIDATION & VERIFICATION (DVV)

(7)	Sahil Jirtode	9373414643	sahiljirtode74@gmail.com	Sahil
(8)	Pranjal Sankar	7385458510	pranjalbarvi234@gmail.com	Pranjal
(9)	Khushi Dave	9890009937	Kd8587477@gmail.com	Khushi
4. Group 1 RPG				
(10)	Raj Sarda	9765801822	raj500108@gmail.com	Raj
(11)	Pratik Shetty	9356716253	pratikshetty182@gmail.com	Pratik
(12)	Gaurav Ekonkar	9665383480	ekonkargaurav1@gmail.com	Gaurav
5. Group: Free thinkers				
(13)	Diya Patil	7757062463	diyapatil553@gmail.com	Diya
(14)	Ruchita Bhayari	9523232626	ruchitabhayari09@gmail.com	Ruchita
(15)	Samiksha Tabhane	9307133863	samikshatabhane@gmail.com	Samiksha

Signature of:

Program In-charge

Department of Computer Science
Dharampeth M. P. Deo Memorial
Science College, Nagpur

COORDINATOR
INTERNAL QUALITY ASSURANCE CELL
DHARAMPETH, M. P. DEO MEMORIAL &
SCIENCE COLLEGE, NAGPUR

Principal
Dharampeth M. P. Deo Memorial
Science College, Nagpur.



DHARAMPETH M. P. DEO MEMORIAL SCIENCE COLLEGE,
North Ambazari Road, Near Ambazari Lake, Nagpur - 440033

DATA VALIDATION & VERIFICATION (DVV)

G. Group: Netal 52			
(16) Meha J Bankar	8055477553	Arhus2009boskhar@gmail.com	<u>Arhus</u>
(17) Tejas Mahurle	7057844382	tejasmahurle94@gmail.com	<u>Tejas</u>
(18) Kamal M Kumbhate	7620314869	KumbhateKamal94@gmail.com	<u>Kamal</u>
700) Shaunak Pathundi	8166629345	shaunak.pathundi@gmail.com	<u>Shaunak</u>
(20) Akshay Singh	7709208740	akshaysingh22@gmail.com	<u>Akshay</u>
(21) Sakshi Huddar	9405142450	huddarsakshi@gmail.com	<u>Sakshi</u>
800) Group: Nsu I Creque	8830224455		
(22) Pranay S. Dhore	7730624245	pranaydhore77@gmail.com	<u>Pranay</u>
(23) Abhishek A. Falke	7823835535	abhishekhalketare@gmail.com	<u>Abhishek</u>
(24) Rishikesh Detha	8788193260	rishikeshdetha2002@gmail.com	<u>Rishikesh</u>
9.00) Sujata D. Soudane	9081135140	sujatasoudane@gmail.com	<u>Sujata</u>

Signature of:

Saxat

Program In-charge

Department of Computer Science

Arhus

COORDINATOR
INTERNAL QUALITY ASSURANCE CELL
DHARAMPETH M. P. DEO MEMORIAL &
SCIENCE COLLEGE, NAGPUR

Arhus

Principal

Principal
Dharampeth M. P. Deo Memorial
Science College, Nagpur



DHARAMPETH M. P. DEO MEMORIAL SCIENCE COLLEGE, NAGPUR
ROTARACT CLUB OF DMPDSVM
Activity Report

Date: 03/10/2022

Name of Organizing Department or Committee: ROTARACT CLUB OF DMPDSVM

Name of the activity: Media Literacy Quiz

Suggested CRITERION point if any: Criterion III & Criterion V

Date of Activity: 30 September 2022

Place of Activity: College

Name of Guest Speaker/s or Judge/s or Chief Guest/s if any: NIL

Title of the Activity: Media Literacy Quiz

Number of Participants: 82

Name of the Teacher In-charge / Convener: Dr. Mrs. Shraddha Deshpande

Names of other Committee Members / Staff: Rotaract Club Members

OUTCOME of the Activity with respect to mission vision of the institute and or academics:

Media literacy is an expanded conceptualization of literacy that includes the ability to access and analyze media messages as well as create, reflect and take action, using the power of information and communication to make a difference in the world. A quiz was designed to understand the spread of media literacy among people around us.

Activity with newspaper coverage if any: NIL

Activity data save in PC of: Department of English

Prof. Pitambar Humane
IQAC Coordinator

CO ORDINATOR
INTERNAL QUALITY ASSURANCE CELL
DHARAMPETH, M. P. DEO MEMORIAL &
SCIENCE COLLEGE, NAGPUR

Dr. Mrs. Shraddha Deshpande
Teacher In-charge

Dr. Akhilesh Peshwe
Principal
Principal
Dharampeth M.P. Deo Memorial
Science College, Nagpur.



DHARAMPETH M.P.DEO MEMORIAL SCIENCE COLLEGE, NAGPUR

ROTARACT CLUB 22-23

Media Literacy Quiz

30th September 2023

Name of the participant	email Address	Total score
MohitKhirdekar	mohitkhirdekar@gmail.com	14.00 / 29
AnkitDhimole	anddhimole9@gmail.com	27.00 / 29
NUPUR SHARMA	nupursharma258@gmail.com	20.00 / 29
Shailendra Sharma	gneshsharmags6019904@gmail.com	28.00 / 29
Muskanvaidya	muskanvaidya9@gmail.com	10.00 / 29
Laxmi SHARMA	mishralaxmi210@gmail.com	29.00 / 29
VineetMukeshsingh	singhvineet78524@gmail.com	10.00 / 29
Saloni Singh	salonisingh68917@gmail.com	16.00 / 29
VedChoudhary	vedchoudhary.cs.749@gmail.com	23.00 / 29
Harsh Moharir	moharir.harshmm@gmail.com	15.00 / 29
Aditi Lute	aditilute161@gmail.com	18.00 / 29
SakshiKubde	sakshikubde04@gmail.com	17.00 / 29
JagrutiFulkawar	jagrutifulkawar@gmail.com	14.00 / 29
YASH Rajput	yash09gaming@gmail.com	15.00 / 29
Sumit Rajesh makwane	sumitmakwane32@gmail.com	12.00 / 29
Bhavanagurudasani	bhavanagurudasani@gmail.com	8.00 / 29
KalyaniPravinFartade	kalyanifartade31@gmail.com	19.00 / 29
Sakshimeshram	sakshimeshram210@gmail.com	18.00 / 29
JanviKosarkar	janvikosarkar@gmail.com	24.00 / 29
KHUSHI PALI	palikhushi4@gmail.com	17.00 / 29
Mrs. Sujata Ali	sujataali@gmail.com	27.00 / 29
Kundanlalvachnalay	veenafulzele6@gmail.com	17.00 / 29
AnkushBhaskar Dhole	ankushdhole17@gmail.com	18.00 / 29
Abhishek P Joshi	joshiabhishek440@gmail.com	15.00 / 29
Anjali Kurve	anjalikurve50@gmail.com	13.00 / 29
PranjaliPrakashNikule	pranjalinikule18@gmail.com	20.00 / 29
Switi Kailas Ganvir	switiganvir2004@gmail.com	20.00 / 29
Ayushkosare	ayushkosare328@gmail.com	14.00 / 29
SaniaMidhat Mohammad AneesRaza	midhatsania@gmail.com	21.00 / 29
Ayushkosare	ayushkosare328@gmail.com	13.00 / 29
Aditya Mishra	adityamishra3933@gmail.com	14.00 / 29
Koshik. M. Punyapawar	shubhangi07pawar@gmail.com	19.00 / 29
DeepaDeshpande	deepaajitdeshpande@gmail.com	10.00 / 29
Nikita shyamBarapatre	prachibarapatre05@gmail.com	19.00 / 29
VeenaBorikar	Veenaborikar14@gmail.com	17.00 / 29
Information technology	omkartijare9@gmail.com	12.00 / 29
JUHI SHESHARAM CHAUDHARI	chaudharijuhi120@gmail.com	18.00 / 29
Manish	manishcharpe53@gmail.com	18.00 / 29
DIVYA KAILASH HANOTE	divyahanote0406@gmail.com	19.00 / 29

Rutik Vijay Gajbhiye	rutikgajbhiye05@gmail.com	18.00 / 29
AryaKulkarni	aryakul2005@gmail.com	13.00 / 29
Kashishbisen	kashishbisen05@gmail.com	17.00 / 29
ShwetaPannase	pannaseshweta31@gmail.com	7.00 / 29
HrishikeshRajendraMahalle	rajendramahalle72@gmail.com	12.00 / 29
Anonymous	anony@gmail.com	18.00 / 29
Niraja	saptarishy.niraja@gmail.com	15.00 / 29
KalyaniThakre	Kalyanilande2@gmail.com	14.00 / 29
ArnavMankar	arnavmankar1607@gmail.com	11.00 / 29
Kalesh mule	werarc1@gmail.com	3.00 / 29
RasikaChandankhede	mymail.rasika@gmail.com	21.00 / 29
kirtiNagdeve	kirtinagdeve095@gmail.comcom	13.00 / 29
AnamSayyad	syedanam510@gmail.com	21.00 / 29
ShantanuKapse	shantanu.sk05@gmail.com	19.00 / 29
JAVED SALMAN NOORMOHAMMAD SHEIKH	jsssheikh7@gmail.com	24.00 / 29
Ritikasondhiya	ritikarsondhiya@gmail.com	15.00 / 29
PritamSurendraKatwe	pritamkatwe655@gmail.com	18.00 / 29
KhushbuPali	palikhushbu59@gmail.com	17.00 / 29
Aayushivikramsingh	singhpri74096@gmail.com	16.00 / 29
AnanyaMotghare	ananyamotghare1802@gmail.com	15.00 / 29
IshitaKhare	ishitakhare18@gmail.com	17.00 / 29
Akshaypandurangmendhe	akshay.mendhe7777@Gmail.com	19.00 / 29
Manikkhisti	manik_khisti@yahoo.com	11.00 / 29
AvishkarBansod	avishkarbansod02@gmail.com	22.00 / 29
VaidehiChinchkhede	vaidehichinchkhede@gmail.com	8.00 / 29
Alisha Mehere	alisha.mehere@gmail.com	18.00 / 29
PawarYashashree Ashok	yashashreepawar37@gmail.com	17.00 / 29
PrachisunilGaikwad	prachigaikawad2705@gmail.com	13.00 / 29
RashiSatpute	rashisatpute77@gmail.com	18.00 / 29
AartiKhanhaiyalalkharole	aartikharole@gmail.com	19.00 / 29
RutikaYadav	yadavrutika434@gmail.com	16.00 / 29
SandhyaSahu	nehasahu15404@gmail.com	19.00 / 29
ArchitKotwala	kotwalaarchit@gmail.com	21.00 / 29
Archita	archikotwala@gmail.com	21.00 / 29
PranjalKulkarni	pranjal.kulkarni80@gmail.com	17.00 / 29
Trushabhsaha	trushabhsaha2004@gmail.com	9.00 / 29
SanchitaPatil	sanchitapatil2003@gmail.com	18.00 / 29
Jyoti Sharma	jyotis8390@gmail.com	13.00 / 29
NutanSurjuse	nutansurjuse2@gmail.com	19.00 / 29
BhagyashreeThakare	thakrebhagyashree2003@gmail.com	19.00 / 29
ISHAN ANKIT	ishanankit5@gmail.com	21.00 / 29
DaminiKatre	daminikatre31@gmail.com	22.00 / 29
Purushottamparashar	parasharpurushottam807@gmail.com	6.00 / 29

Dr. Mrs. Shraddha Deshpande
 Teacher In-charge



DHARAMPETH M. P. DEO MEMORIAL SCIENCE COLLEGE, NAGPUR

INTERNAL QUALITY ASSURANCE CELL (IQAC)

Activity Report

Date: 01/10/2022

Name of Organizing Department or Committee: Department of Physics

Name of the activity: NEP based Demonstration Activity for B.Sc. Semester-III

Suggested CRITERION point if any: Restricted to RTMNU B.Sc. physics syllabus.

Date of Activity: 01/10/2022

Place of Activity: Room no. 003

Name of Guest Speaker/s or Judge/s or Chief Guest/s if any: NA

Title of the Activity: Demonstration on refraction using coin & cup.

Activity with newspaper coverage if any: No

Number of Participants: B.Sc. Semester-III Students - 54

Name of the Teacher In-charge / Convener: Ms. Amrapali K. Meshram

Names of other Committee Members / Staff: N.A.

OUTCOME of the Activity with respect to academics:

B.Sc. Semester-III students to learn the phenomenon of refraction. In this activity, coin kept in a cup & move away from it, coin could not be seen because light not bent at the rim of the cup. But, when water added in the cup & incident light fall on it, light enters water through air, it bent & refracts. This demonstration helped students to understand the concept of optical phenomenon of refraction.

DVV: Enclosed.

Activity data save in PC of: Lt. Dr. P. W. Ambekar

Prof. Pitambar Humane
IQAC Coordinator

CO ORDINATOR
INTERNAL QUALITY ASSURANCE CELL
DHARAMPETH, M. P. DEO MEMORIAL &
SCIENCE COLLEGE, NAGPUR

Name & Signature of Teacher In-charge

Dr. Akhilesh Peshwe
Principal

Dharampeth M.P. Deo Memorial
Science College, Nagpur.



DHARAMPETH M. P. DEO MEMORIAL SCIENCE COLLEGE NAGPUR

Department of Physics

NEP ACTIVITY

Paper- 2

Unit- I

Class: B.Sc. Sem.- III

Name of the Teacher: Arapali MochramDate: 01/10/2022Title of Activity: Demonstration of refractive index using coin and cup

Sr. No.	Name of Student	Batch	Mobile No.	Email ID	Signature
---------	-----------------	-------	------------	----------	-----------

1	Mansi Ashok Badole	S-8	7196308467	mansibadole@gmail.com	<u>Badole</u>
2	Kajal P. Maladhar Prasad	S-8	7410763138	prasadkaj@gmail.com	<u>Prasad</u>
3	Jasraj Devital Patil	S-8	9320820325	jasrajpatil147@gmail.com	<u>Jasraj</u>
4	Atharva Vinod Ingle	S-7	9022468636	atharva.ingle73@gmail.com	<u>Ingle</u>
5	Amish R. Basilkar	S-5	9579645072	amishbasilkar63@gmail.com	<u>Basilkar</u>
6	Ritul K. Bisen	S-5	7028810840	ritulbisen08@gmail.com	<u>Bisen</u>
7	Shweta Bedwal	S-5	8080940984	shwetabedwal26@gmail.com	<u>Bedwal</u>
8	Kajal P. Nijhot	S-8	9373250623	kajurnijhot2000@gmail.com	<u>Nijhot</u>
9	Mansi S. Fatimng	S-8	8767154686	mansifatimng2110@gmail.com	<u>Fatimng</u>
10	Aasmin K. Sheikh	S-3	8668323578	aasmin5029@gmail.com	<u>Sheikh</u>
11	Rajyanka S. Shah	S-3	7385197365	rs3347311@gmail.com	<u>Rajyanka</u>
12	Shraddha B. Rajje	S-10	7776804083	shraddharaaje66@gmail.com	<u>Rajje</u>
13	Simran Taimare	S-10	7972530338	simranur@gmail.com	<u>Taimare</u>
14	Anuj Mishra	S-5	8103656208	anujmishra251202@gmail.com	<u>Mishra</u>
15	Atharva P. Umate	S-5	9284641511	atharva.umate@gmail.com	<u>Umate</u>
16	Sakshi M. Ingle	S-9	9087871694	inglesakshi703@gmail.com	<u>Ingle</u>
17	Ananya B. Mohghare	S-7	5219218355	ananya.mohghare@gmail.com	<u>Mohghare</u>
18	Aditi J. Jute	S-5	7820812303	aditijute10@gmail.com	<u>Jute</u>
19	Apurva S. Venulkar	S-7	9623613911	apurva.venulkar@gmail.com	<u>Venulkar</u>
20	Komal S. Patil	S-8	9881748506	komalpatil27@gmail.com	<u>Patil</u>
21	Nupur Sharma	S-8	9822042259	nupursharma59@gmail.com	<u>Sharma</u>
22	Prakhar B. Badkar	S-3	8329760858	Prakhar.Badkar@gmail.com	<u>Badkar</u>
23	Shravya Anjee Thakare	S-5	8766925275	thakareshravya2002@gmail.com	<u>Thakare</u>
24	Damini Katre	S-5	8208255685	damini.katre@gmail.com	<u>Katre</u>
25	Sandhya Patil	S-5	7218079074	sandhyapatil1209@gmail.com	<u>Patil</u>
26	Nutan Suruse	S-5	8805570279	nutansuruse2@gmail.com	<u>Suruse</u>

Signature of Teacher

Head of Department

- 27] Adityakumar Shukla S-5 9518994638 adityashukla0028@gmail.com
- 28] Nitin Kushwaha S-5 9693929005 nitinkushwaha706@gmail.com
- 29] Divya Hanote S-8 8605422901 divyahanote0406@gmail.com Divya
- 30] ~~Nupur Sharma~~
- 31] Chetan Bapche S-3 972484628 chetanbapche27@gmail.com Chetan
- 32] Prachin K. Kottalwar S-9 7498102077 PrachinKottalwar@gmail.com Prachin
- 33] Vrushali shahare S-1 9307516332 Vrushalishahare25@gmail.com Vrushali
- 34] Bhumika U. Thakre S-7 7212247917 Bhumika-thakre-55@gmail.com Bhumika
- 35] Kunal Digraje S-5 8010274303 kunaldigraje@gmail.com Kunal
- 36] Dhammapuraji Lale S-7 9975037356 dhammapurajilale@gmail.com Dhammapuraji
- 37] Rushali D. Bhaskar S-9 9579485597 bhaskar.rushali@gmail.com Rushali
- 38] Ashmit J. Juvan S-7 8080835161 ashmitjuvan@gmail.com Ashmit
- 39] Pawan S. Vishwakarma S-3 7058408869 pawansvishwakarma@gmail.com Pawan
- 40] Swanandi Dhawan S-10 7420880982 swanandidhawan9@gmail.com Swanandi
- 41] Suchika Patle S-9 8669335907 suchikapatle4@gmail.com Suchika
- 42] Dhammapuraji Lale S-7 9975037356 dhammapurajilale@gmail.com Dhammapuraji
- 43] Hitesh G. Kaware S-5 7058827112 hiteshkaware73@gmail.com Hitesh
- 44] Hemant C. Mishra S-5 9067445755 hemantmishra10@gmail.com Hemant
- 45] Akshay P. Khondare S-5 7350956808 akshaykhondare79@gmail.com Akshay
- 46] Omkumar D. Devanjan S-5 9763624588 omkumarddevanjan@gmail.com Omkumar
- 47] Aditya Kumar Singh S-5 7350543901 adityasingh288180@gmail.com Aditya
- 48] Dinesh Partoli S-7 9623389676 dineshp11@gmail.com Dinesh
- 49] Rohit S. Wanjari S-9 7741061907 rohitwanjari1@gmail.com Rohit
- 50] Pratik O. Lihare S-9 9307480168 pratiklihare30@gmail.com Pratik
- 51] Mithilam Prasad S-8 7552719534 mithilamprasad45@gmail.com Mithilam
- 52] Ayaz Sheikh S-7 8767355583 ayazsheikh259068@gmail.com Ayaz
- 53] Vaishali S. Nimje S-9 9579995069 vaishalinimje007@gmail.com Vaishali
- 54] Vatan S. Sonwane S-9 9975410765 vatansonwane@gmail.com Vatan



DHARAMPETH M. P. DEO MEMORIAL SCIENCE COLLEGE, NAGPUR

**INTERNAL QUALITY ASSURANCE CELL (IQAC)
Activity Report**

Date: 01/10/2022

Name of Organizing Department or Committee: Department of Physics

Name of the activity: NEP based Demonstration Activity for B.Sc. Sem-I

Suggested CRITERION point if any: Restricted to RTMNU BSc physics syll.

Date of Activity: 01/10/2022

Place of Activity: Room No. 004

Name of Guest Speaker/s or Judge/s or Chief Guest/s if any: NA

Title of the Activity: Demonstration of elasticity of a glass bottle using surface tension

Activity with newspaper coverage if any: No

Number of Participants: BSc Sem-I Students- 10

Name of the Teacher In-charge / Convener: Mr. Nikhil Somkule

Names of other Committee Members / Staff: N.A.

OUTCOME of the Activity with respect to academics:

This demonstration provided a unique opportunity to BSc Sem-I students to learn the phenomenon of surface tension and elasticity. In this activity a glass bottle was fitted with a capillary tube and when the bottle was pressed the water level was seen increased in the capillary. This demonstration helped students to understand the concept of elasticity of a glass like material clearly.

DVV: Enclosed.

Activity data save in PC of: Lt. Dr. P. W. Ambekar

Prof. P. W. Ambekar
IQAC Coordinator
DHARAMPETH, M. P. DEO MEMORIAL &
SCIENCE COLLEGE, NAGPUR

Name & Signature of Teacher in-charge
HEAD
DEPARTMENT OF PHYSICS
Dharampeth M. P. Deo Memorial
Science College, Nagpur

Dr. Akhilesh Peshwe
Principal

Principal
Dharampeth M.P. Deo Memorial
Science College, Nagpur.



DHARAMPETH M. P. DEO MEMORIAL SCIENCE COLLEGE, NAGPUR
INTERNAL QUALITY ASSURANCE CELL (IQAC)

Activity Report

Date: 30/10/2022

Name of Organizing Department or Committee: Home Science Department

Name of the activity: Workshop on Garment making (Apron/Frock)

Suggested CRITERION point if any: Criteria II & V

Date of Activity: 03/10/2022 to 04/10/2022

Place of Activity: Classroom

Name of Guest Speaker/s or Judge/s Resource Person if any: Miss. Sonam Mishra

Title of the Activity: Workshop on Garment making (Apron/Frock)

Number of Participants: 13 students of Semester I

Name of the Teacher In-charge / Convener: Ms. Ankita Wankhede

Names of other Committee Members / Staff: Mrs. Manju Deshpande

OUTCOME of the Activity with respect to mission vision of the institute and or academics:

1. Students learn about parts of sewing machine, and how time to time oiling, maintenance, cleaning of sewing machine.
2. They learn how to take body measurement.
3. Students gain knowledge of different types of cloth used for making apron and baby frock.

Activity with newspaper coverage if any: _____

Activity data save in PC of: Home Science Staff Room Desktop

Note: Kindly share geotag photographs separately along with report on iqacdsc2022@gmail.com



[Handwritten Signature]

Prof. Pitambar Humane
 CO-ORDINATOR
 INTERNAL QUALITY ASSURANCE CELL
 DHARAMPETH, M. P. DEO MEMORIAL &
 SCIENCE COLLEGE, NAGPUR

[Handwritten Signature]

[Handwritten Signature]

Name & Signature of Teacher In-charge

[Handwritten Signature]

Dr. Akhilesh Peshwe
 Principal
 PRINCIPAL

Dharampeth M. P. Deo Memorial
 Science College, Nagpur-440033

DHARAMPETH M P DEO MEMORIAL SCIENCE

DEPARTMENT OF HOME SCIENCE

NOTICE

All the Students are informed that organizing Two day Workshop on Garment making (Apron/Frock) for B.Sc Home Science Semester Ist. Workshop is arranged in Home Science Department on 03/10/2022 to 04/10/2022. Attendance is mandatory. Mode of programme is offline/online.



Name of Teacher Incharge



Head of the Department

To,
The Head of the Department,
Dharampeth M.P. Deo Memorial
Science College Nagpur.
Date :-

Subject: Request for conducting Garment making (Textile) workshop for B.Sc Home Science Semester I students.

Respected Madam,

This is to request you to please grant us permission for conducting workshop on textile garment making which is mention in the syllabus for B.Sc Home Science Semester I students on 03/10/2022 to 04/10/2022.

Hope you will grant us permission for the above.

Thanking You,

M. Deshpande
1.10.22

Yours Faithfully,

Ankita
Ms. Ankita Wankhede

[Signature]
PRINCIPAL
Dharampeth M.P. Deo Memorial
Science College, Nagpur-440033

Workshop on Garment Making

03/10/22
04/10/22



DHARAMPETH M. P. DEO MEMORIAL SCIENCE COLLEGE,
North Ambazari Road, Near Ambazari Lake, Nagpur- 440033

DATA VALIDATION & VERIFICATION (DVV) 1st Sem

Name	MOBILE NO	E-mail	Signature
1) Aditi . R. Vaidya	9075714591	aditivaidya619@gmail.com	
2) Astha . P. Bhowray	9156003906	asthabhowray2002@gmail.com	
3) Gayatri N. Varma	9763287531	gayatriveerma60@gmail.com	
4) Anshikha U. Jaiswariker	9021391207	anshikhajaiswariker@gmail.com	
5) Parna J. Chaudhari	1620304149	parnishchaudhari07@gmail.com	
6) Shubhangi R. Nishad	9518534076	shubhishateshi@gmail.com	
7) Hemlata D. Verma	7517058379	varmahemlata957@gmail.com	
8) Bhavna . A. Gaudasani	8888937303	bhavnaofaudasani@gmail.com	
9) SAKSHI . R. CHAKURDE	7843018801	sakshi.chakurde@gmail.com	
10) Neha L. Suresant	9057167842	Nehasuresant@gmail.com	
11. Neha . R. Vishwakarma	9975846970		
12. Shalu P. Paridhi	8329115380	shaluparidhi@squail.com	
13. Minal Jalle	7350730164		

Signature of:

Programme In-charge

Ms. Ankita Wankhede

IQAC Coordinator

DHARAMPETH M. P. DEO MEMORIAL SCIENCE COLLEGE, NAGPUR-440033

PRINCIPAL

Dharampeth M. P. Deo Memorial Science College, Nagpur-440033



DHARAMPETH M. P. DEO MEMORIAL SCIENCE COLLEGE, NAGPUR

INTERNAL QUALITY ASSURANCE CELL (IQAC)

Activity Report

Date: 3rd October 2022

Name of Organizing Department or Committee : Electronics Department

Name of the Activity : Simple Programs using Data transfer and logical instructions using Simulator(NEP)

Suggested CRITERION point if any : Suggested criteria II

Date of Activity : 3rd October 2022

Place of Activity : Electronics Lab

Name of Guest Speaker/s or Judge/s or Chief Guest/s if any : Not applicable

Title of the Activity: Simple Programs using Data transfer and logical instructions using Simulator

Based on Unit : 2(Paper II)

Class : Semester V

Number of Participants : 30

Name of the Teacher In-charge / Convener: Prof. V. V. Rangari

OUTCOME of the Activity with respect to mission vision of the institute and or academics:

Students learn how to use the Simulator for 8085 Microprocessor Programming and done simple programs using data transfer and logical instructions.

Prof. Varsha V. Rangari

Head of the Department



Prof. Pitambar Humane

IQAC Coordinator

CO ORDINATOR

INTERNAL QUALITY ASSURANCE CELL
DHARAMPETH, M. P. DEO MEMORIAL &
SCIENCE COLLEGE, NAGPUR

Dr. Akhilesh Peshwe

Principal
Dharampeth M.P. Deo Memorial
Science College, Nagpur.



Dharampeth M. P. Deo Memorial Science College,
Nagpur

Electronics Department

Semester V - (2022-23)

Activity 2

Based on Paper II -Unit 2

Date: 3/10/22

Activity: Simple Programs using Data transfer and Logical instructions using Simulator

Objective:

- To Know the use of instructions.

Sr. No.	Students Name	Signature
1.	Aadesh Kamal Kishan Dubey	
2.	Aavli. B. Singh	
3.	Megha T. Bisen	
4.	AGHIS BETS. MANHAR	
5.	Bhavesh R. Maske	Bhavesh R.
6.	Ankita Sonawane	
7.	Ankit Singh	
8.	MUKUND HOOD	
9.	Nikhil K. Jankar	
10.	Pranav Mahajan	Pranav.
11.	Kaustik. K. P. Tiwari	
12.	Ankur D. Singh	
13.	Karan R. Waghade	
14.	Mahesh. P. Maske	
15.	Prakash Khandal	
16.	Shannak Balkundi	
17.	Soukabh. P. Sharma.	
18.	Tanmay. S. Gadam	T.S Gadam



DHARAMPETH M. P. DEO MEMORIAL SCIENCE COLLEGE, NAGPUR

Department of Electronics

Semester V- (2022-23)

ACTIVITY 2 (Paper II- Unit- 2)

Sr. No.	Student Name	Mobile Number	Email ID
1	Adesh Kamalkishor Dubey	9527898267	Adesh222@gmail.com
2	Aarti Brijkishor Singh	7709208740	aartibsingh222@gmail.com
3	Megha Tribhuwan Bisen	9637770341	bisenmegha320@gmail.com
4	Abhijeet Shrikant Mankar	8309664405	abhijeetmankar5@gmail.com
5	Bhavesh Rameshwar Maske	7489951631	bhaveshmaske2002@gmail.com
6	Ankita Laxman Sonwane	9284801790	ankitasonwane10@gmail.com
7	Ankit Dilip Singh	9307189124	as4212892@gmail.com
8	Mukund Sanjay Hood	9604785822	mukundahood2003@gmail.com
9	Nikhil Kiran Ijankar	8530960407	nikhilijankar@gmail.com
10	Pranay Santosh Mahajan	9158377419	pranaymahajan413@gmail.com
11	Kartik Kamal Parasad Tiwari	9156498206	tiwarikartik292@gmail.com
12	Ankur Singh	7507990175	akashdsingh059@gmail.com
13	Kiran Ramesh Waghade	9860218676	rameshwaghade20@gmail.com
14	Mahesh Prabhakarrao Maske	9021951173	maheshmaske48@gmail.com
15	Prakash Madhuvilas Khanal	7796875388	Khanalprakash151@gmail.com
16	Shaunak Subodh Balkundi	8446629345	
17	Saurabh Pratap Sharma	9130964601	saurabhs44002@gmail.com
18	Tanmay Sunil Gadam	7262034396	tanmaygadaml@gmail.com
19	Riddhi Abhay Rajkarne	8669809201	riddhirajkarne@gmail.com
20	Rani Devidas Kokate	7998945148	ranikokate1009@gmail.com
21	Soniya Bhishamber Chaniya	7028563411	rvchaniya@gmail.com
22	Samiksha Vasant Tabhane	9307133863	samikshavtabhane@gmail.com

23	Pratiksha Shamrao Umare	8806402970	pratiksha2019uu@gmail.com
24	Sakshi Sanjay Huddar	9405142450	huddarmahi@gmail.com
25	Prathmesh Sanju Badhiye	9765262138	nikita24badhiye@gmail.com
26	Sakshi Satish Hiwarkar	9356651344	Sakshihiwarkar1831@gmail.com
27	Pratik Deepak Ingle	7057937510	inglepratik92@gmail.com
28	Sagar Omprakash Sonwane	9356591564	sagarsonwane706@gmail.com
29	Pratham Manbahadur Sonar	7558464862	manbhaisonar@gmail.com
30	Rajat Laxman Rohad	9175635273	

Name & Signature of Teacher In-Charge

[Signature]

Prof. Pitambar Humane
IQAC Coordinator
CO ORDINATOR
INTERNAL QUALITY ASSURANCE CELL
DHARAMPETH, M. P. DEO MEMORIAL &
SCIENCE COLLEGE, NAGPUR

Name & Signature of Head of the Department

[Signature]

Dr. Varsha V. Rangari
Professor & Head
Department of Electronics
Dharampeth M.P. Deo Memorial
Science College, Nagpur

[Signature]

Dr. Akhilesh Peshwe
Principal
Principal
Dharampeth M.P. Deo Memorial
Science College, Nagpur.



DHARAMPETH M. P. DEO MEMORIAL SCIENCE COLLEGE, NAGPUR
INTERNAL QUALITY ASSURANCE CELL (IQAC)
Activity Report

Date: 3-10-2022

Name of Organizing Department or Committee: Department of Statistics.

Name of the activity: Finding probability mass function by using graph.

Suggested CRITERION point if any:

Date of Activity: 3 october 2022

Place of Activity: Statistics lab

Name of Guest Speaker/s or Judge/s or Chief Guest/s if any:

Title of the Activity: Finding probability mass function by using graph.

Number of Participants: 23

Name of the Teacher: Durga hingwe

Names of other Committee Members / Staff: N.A.

OUTCOME of the Activity with respect to mission vision of the institute and or academics:

In this activity students know , A probability mass function is a function that assigns a probability to each possible outcome of an even and it is a way of computing the probability. Some application like comparing the probabilities of different events.

Activity with newspaper coverage if any: No

Activity data save in PC of: Department of Statistics

Prof. Pitambar Humane
IQAC Coordinator

CO ORDINATOR
INTERNAL QUALITY ASSURANCE CELL
DHARAMPETH, M. P. DEO MEMORIAL &
SCIENCE COLLEGE, NAGPUR

Name & Signature of Teacher In-charge

Dr. Akhilesh Peshwe
Principal
Principal

Dharampeth M.P. Deo Memorial
Science College, Nagpur.



DHARAMPETH M. P. DEO MEMORIAL SCIENCE COLLEGE NAGPUR

Department of Statistics

Class: B.Sc. Sem.-I

NEP ACTIVITY

Paper-1

Unit III

Name of the Teacher: Durga C. Hingwe

Date: 3-10-2022

Title of Activity: finding probability mass functⁿ by using graph.

Sr. No.	Name of Student	Batch	Mobile No	Email ID	Signature
1.	Dinyani V. Zagade	F2	9022866318	dinyanizagade@gmail.com	<u>DZ</u>
2.	Jasmi. V. Khode	F2	7385066634	JasmiKhode892@gmail.com	<u>Jasmi</u>
3.	Pranali R. Dehankar	F2	8267581278	Pdehna@gmail.com	<u>Pranali</u>
4.	Nisha S. Kewalkar	F2	9090996645	nishakewalkar23@gmail.com	<u>Nisha</u>
5.	Utkarsha S. Trigale	F2	7499159178	utkarshaingale9@gmail.com	<u>Utkarsha</u>
6.	Vidya Lohi	F2	7020963219	Vidyalohi8@gmail.com	<u>Vidya</u>
7.	Sakshi Mishra	F2	9529889315	Smishra439683@gmail.com	<u>Sakshi</u>
8.	Janhvi Laibey	F2	8446510539	Janhvilaihey@gmail.com	<u>Janhvi</u>
9.	Rutika Yadav	F2	8046085943	yadavarutika434@gmail.com	<u>Rutika</u>
10.	Mohit Khindekar	F2	8655328357	mohitkhindekar@gmail.com	<u>Mohit</u>
11.	Veena Borikar	F2	9322010921	veenaborikar14@gmail.com	<u>Veena</u>
12.	Janhvi Joge	F2	7385060871	JanhviJoge08@gmail.com	<u>Janhvi</u>
13.	Pranali Gupta	F2	9020069377	29991537@gmail.com	<u>Pranali</u>
14.	Jagruati Fullkawkar	F2	8767911307	Jagruatifullkawkar@gmail.com	<u>Jagruati</u>
15.	Shruti Niwal	F2	7088425021	niwalshruti970@gmail.com	<u>Shruti</u>
16.	Chetna Buije	F2	8010342968	buijetchetna@gmail.com	<u>Chetna</u>
17.	Devashree Kakale	F2	9021344265	kakaledevashree@gmail.com	<u>D.P. Kakale</u>
18.	Janhvi Kinnappa	F2	7058235243	janhvikinnappa@gmail.com	<u>Kinnappa</u>
19.	Pradnya Tripathi	F2	8010362232	pradnyatripathi9145@gmail.com	<u>Pradnya</u>
20.	Vivek S. Sah	F1	9923763071	vivek.sah1878@gmail.com	<u>Vivek</u>
21.	Nayan N. Matthare	F1	7841870947	nayanmatthare9@gmail.com	<u>Nayan</u>
22.	Shruti N. Deshpande	F2	930091540	shrutideshpande21004.com	<u>Shruti</u>
23.	Varsha L. Turkar	F2	9373650950	vashaturkar488@gmail.com	<u>Varsha</u>

D. Hingwe
Signature of Teacher

D. Hingwe
Teacher Incharge



Activity Report

Date: 5/10/2022

Name of Organizing Department or Committee: Chemistry

Name of the activity: Display of Model and chart based on NEP & B.Sc. Chemistry syllabus

Suggested CRITERION point if any: Criteria II

Date of Activity: 4/10/ 2022

Place of Activity: Chemistry Department

Name of Guest Speaker/s or Judge/s or Chief Guest/s if any: Prof. Pitambar Humne

Title of the Activity: Chemistry Syllabus based poster and Models

Number of Participants: 154

Name of the Teacher In-charge / Convener: Dr. vaishali ,Meshram

Names of other Committee Members / Staff: Dr. Pranita Gawande & Dr. Yogita Dahire

OUTCOME of the Activity with respect to mission vision of the institute and or academics:

Student prepared the poster model which were based on syllabus of chemistry so they understood experience learning though the poster and model they have got the very clear idea about concept in chemistry.

Activity with newspaper coverage if any: No

Activity data save in PC of: Chemistry

Note: Kindly share geotag photographs separately along with report on iqacds2022@gmail.com



Prof. Pitambar Humane
IQAC Coordinator

Name & Signature of Teacher In-charge

Dr. Akhilesh Peshwe
Principal

CO ORDINATOR
INTERNAL QUALITY ASSURANCE CELL
DHARAMPETH, M. P. DEO MEMORIAL &
SCIENCE COLLEGE, NAGPUR

PRINCIPAL
Dharampeth M.P. Deo Memorial
Science College, Nagpur-440033



DHARAMPETH M. P. DEO MEMORIAL SCIENCE COLLEGE,
North Ambazari Road, Near Ambazari Lake, Nagpur- 440033

DATA VALIDATION & VERIFICATION (DVV)

Name of the Programme : Chemistry exhibition Sem I (PCM)
Date of the Programme : 4-10-22 (Dr. Parvita Gawande)
Name of Chief Guest if any : -
Name of Guest Speaker if any : -

Sr. No.	Name of the Participant	Mobile Number	E-mail Id	Signature
1.	Shivam U. Patel	7038889083	Spur0263@gmail.com	Shivam
2.	Ankit Patel	9970905638	Ankitpatel197275@gmail.com	Ankit
3.	Durgesh Ghodmare	9075318618	Durgeshghodmare00@gmail.com	Durgesh
4.	Ruchi Dwivedi	8080776893	Ruchidwivedi230@gmail.com	Ruchi
5.	Abul D. Bisen	8446448100	abulbisen7049@gmail.com	Abul
6.	Pravin Thakre	8262969713	Lhakarepravin783@gmail.com	Pravin
7.	Nihel V. Meshram	8767792960	nihelmeshram73@gmail.com	Nihel
8.	Nikhil R. Kumbhar	8999040961	kumbharnikhil17@gmail.com	Nikhil
9.	Ankit R. Patel	9970905638	anankitpatel703@gmail.com	Ankit
10.	Monika I. Patel	9399225668	monika patel703@gmail.com	Monika

Signature of:

Programme In-charge

IQAC Coordinator

CO ORDINATOR
INTERNAL QUALITY ASSURANCE CELL
DHARAMPETH, M. P. DEO MEMORIAL &
SCIENCE COLLEGE, NAGPUR

Principal

Dharampeth M. P. Deo Memorial
Science College, Nagpur-440033



DHARAMPETH M. P. DEO MEMORIAL SCIENCE COLLEGE,
North Ambazari Road, Near Ambazari Lake, Nagpur- 440033

DATA VALIDATION & VERIFICATION (DVV)

(SEM 8) (PCMC)

Name of the Programme : CHEMISTRY MODEL AND CHART EXHIBITION (Dr. Mrs. Manodhi R. Kerkar)
Date of the Programme : 04-10-2022
Name of Chief Guest if any : -
Name of Guest Speaker if any : -

Sr. No.	Name of the Participant	Mobile Number	E-mail Id	Signature
1.	Chaitali M. Burhade	9359540394	chaitali20206@gmail.com	Chaitali
2.	Vishal Kumar Singh	9610187223	singhulshal9602@gmail.com	Vishal
3.	Abhishek D. Das	7058933157	ad04092001@gmail.com	Abhishek
4.	Khushi D. Sundhakar	8767279513	khushisundhakar682@gmail.com	Khushi
5.	Akansha Yeluri	8767935524		Akansha
6.	Prityanshi Singh	7219259020	prityanshisingh1804@gmail.com	Prityanshi
7.	Valika P. Karantkar	9145149787	valika.karantkar@gmail.com	Valika
8.	Priyanka D. Bohane	7620740373	priyankabohane76@gmail.com	Priyanka
9.	Pallavi Y. Bhagat	9022654940	Pallavi.m2208@gmail.com	Bhagat
10.	Raksha D. Dhote	7498511875	Rakshadhote3@gmail.com	R. Dhote

Signature of:

Programme In-charge

IQAC Coordinator
CO ORDINATOR
INTERNAL QUALITY ASSURANCE CELL
DHARAMPETH, M. P. DEO MEMORIAL &
SCIENCE COLLEGE, NAGPUR

Principal
PRINCIPAL
Dharampeth M.P. Deo Memorial
Science College, Nagpur-440033



DHARAMPETH M. P. DEO MEMORIAL SCIENCE COLLEGE,
North Ambazari Road, Near Ambazari Lake, Nagpur- 440033

DATA VALIDATION & VERIFICATION (DVV)

Name of the Programme : Chemistry Model & chart exhibition
Date of the Programme : 4/10/2022
Name of Chief Guest if any : -
Name of Guest Speaker if any : -

Sr. No.	Name of the Participant	Mobile Number	E-mail Id	Signature
11	Megha S. Julwar	8605389606	Mjulwar@gmail.com	Mjulwar
12	Tanushree Date	9446927406	tanushree2002@gmail.com	Tanushree
13	Aditi Dhobte	8847709571	aditidhobte4@gmail.com	Aditi
14	Tanmay Bhute	7697250831	tanmaybhute900@gmail.com	Tanmay
15	Shivam Maurya	9607873702	ShivamMaurya12911@gmail.com	Shivam
16	Ishwanth. Suryawanshi	8087217297	SuryawanshiIshwanth@gmail.com	Ishwanth
17	Nikita R. Rahangdale	9307723308	nikitarahangdale2005@gmail.com	Nikita
18	Aachal Wagh	8519643389	aachalwagh2003@gmail.com	Aachal
19	Nikita D. Shebe	9021019101	nikita.shebe2009@gmail.com	Nikita
20	Divya Bondre	8668454925	divyabondre3@gmail.com	Divya

Signature of:

Programme In-charge

IQAC Coordinator
COORDINATOR
INTERNAL QUALITY ASSURANCE CELL
DHARAMPETH, M. P. DEO MEMORIAL &
SCIENCE COLLEGE, NAGPUR

Principal
Dharampeth M. P. Deo Memorial
Science College, Nagpur-440033



DHARAMPETH M. P. DEO MEMORIAL SCIENCE COLLEGE,
North Ambazari Road, Near Ambazari Lake, Nagpur- 440033

DATA VALIDATION & VERIFICATION (DVV)

21	Rani D. Patel	788824794	ranipatel5515@gmail.com	Rani
22	Roji N. Pathan	8669595198	Rojilnhan@gmail.com	R. Pathan
23	Khushi Sundhkar	8767279513	khushisundhkar@gmail.com	Khushi
24	Sakshi Moon	7745827136	sakshim3030@gmail.com	S.Moon
25	Anjali Namdev Charde	8261964188	anjalicharde20@gmail.com	A.Charde
26	Nikita Ekse	7972140515	eksenilita314@gmail.com	ek
27	Shivani Bhute	9302500209	bhushivani899@gmail.com	Shivani
28	Anshuman Sharma	9370892462	sharmaanshuman@gmail.com	Anshuman
29	Chetan Kamthe	9637271601	kamthechetan6@gmail.com	Chetan Kamthe
30	Vedika Karunkar	9145149787	vedikakarunkar@gmail.com	Vedika
31	Priyanka Acharya	7620740373	priyankabhatnagar@gmail.com	Priyanka
32	Ashu Patil	7887934824	ashupatil2002@gmail.com	Ashu
33	Adesh Hattarwar	7517431162	adeshhattarwar2000@gmail.com	A.Hattarwar
34	Damini Bandbuche	8275105785	daminibandbuche@gmail.com	Damini
35	Sneha R. Gurnule	9446166500	snehagurnule2000@gmail.com	Sneha

Signature of:

Programme In-charge

CO ORDINATOR
INTERNAL QUALITY ASSURANCE CELL
DHARAMPETH, M. P. DEO MEMORIAL &
SCIENCE COLLEGE

Principal
Dharampeth M. P. Deo Memorial
Science College, Nagpur-440033



DHARAMPETH M. P. DEO MEMORIAL SCIENCE COLLEGE,
North Ambazari Road, Near Ambazari Lake, Nagpur- 440033

DATA VALIDATION & VERIFICATION (DVV)

(Sem V) (Biology)

Name of the Programme : CHEMISTRY MODEL AND CHART EXHIBITION (Dr. Mrs. Maulvi R. Keskar)
Date of the Programme : 04-10-2022
Name of Chief Guest if any : _____
Name of Guest Speaker if any : _____

Sr. No.	Name of the Participant	Mobile Number	E-mail Id	Signature
36	Anjali R. Pali	7498102109	pali.anjali446@gmail.com	
37	Asha Shamara W Ladge	9322231581	ashaladge0601@gmail.com	
38	Vaishnavi R. Chandekar.	7249882964	—	
39	Neha Ravindra Kharuse	8766738840	neha2002kk@gmail.com	

Signature of:
Programme In-charge

COORDINATOR
INTERNAL QUALITY ASSURANCE CELL
DHARAMPETH, M. P. DEO MEMORIAL &
SCIENCE COLLEGE, NAGPUR

PRINCIPAL
Dharampeth M.P. Deo Memorial
Science College, Nagpur-440033.



DHARAMPETH M. P. DEO MEMORIAL SCIENCE COLLEGE,
North Ambazari Road, Near Ambazari Lake, Nagpur- 440033

DATA VALIDATION & VERIFICATION (DVV)

Name of the Programme : Chemistry Model and Chart exhibition
Date of the Programme : 4/10/2022
Name of Chief Guest if any : -
Name of Guest Speaker if any : -

Sr. No.	Name of the Participant	Mobile Number	E-mail Id	Signature
1	Aditi U. Kaloo	9623739760	aditikaloo2002@ gmail.com	Kaloo
2	Vijaya R. Yele	2668731173	Vijaya.katie@52@ gmail.com	Yele
3	Manju A. Prajapati	7758002551	Prajapati.manju90@ gmail.com	Manju
4	Gayatri G. Funder	8669311098	gayatrifunder1@ gmail.com	Funder
5	Supriya N. Telang	9970896748	supriyatelang01@ gmail.com	Supriya
6	Diksha K. Tomgarde	7798062845	dikshatomgarde2162@ gmail.com	Tomgarde
7)	Vaibhav N. Sawkar	7040642840	Vaibhav.sawkar.03@ gmail.com	Sawkar
8)	Shashank I. Hanware	8669204496	shashankhanware@ gmail.com	Hanware
9)	Akonksha V. Badade	9145226326	akankshabadade90@ gmail.com	Badade
10)	Pallavi M. Patle	9673986807	pallavipatle2405@ gmail.com	Patle

Signature of:

Programme In-charge

IQAC Coordinator
CO ORDINATOR
INTERNAL QUALITY ASSURANCE CELL
DHARAMPETH, M. P. DEO MEMORIAL &
SCIENCE COLLEGE, NAGPUR

Principal
PRINCIPAL
Dharampeth M. P. Deo Memorial
Science College, Nagpur-440033



DHARAMPETH M. P. DEO MEMORIAL SCIENCE COLLEGE,
North Ambazari Road, Near Ambazari Lake, Nagpur- 440033

DATA VALIDATION & VERIFICATION (DVV)

Name of the Programme : Chemistry Model & Chart Exhibition
Date of the Programme : 4/10/2022
Name of Chief Guest if any : Prof. Pitamber Humane
Name of Guest Speaker if any : -

Sr. No.	Name of the Participant	Mobile Number	E-mail Id	Signature
1	Utkarsh Nandeshwar	8983787258		
2	Rishu Bagde	9511654238		
3	Sumit Achare	9356293570		
4	Khumesht Sidam	9307391945		
5	Shraddha Bhakre	9356944630		
6	Yukti Dhurwadhapade	7058249794		
7	Harsh Nagpure	8459498693		
8	Chaitanya Rahangdale	9764466032		
9	Chaitali Wasniker	9021355857		
10	Raghu Bohane	9359825302		

Signature of:

Programme In-charge

IQAC Coordinator
CO ORDINATOR
INTERNAL QUALITY ASSURANCE CELL
DHARAMPETH, M. P. DEO MEMORIAL &
SCIENCE COLLEGE, NAGPUR

Principal
PRINCIPAL
Dharampeth M.P. Deo Memorial
Science College, Nagpur-440033



DHARAMPETH M. P. DEO MEMORIAL SCIENCE COLLEGE,
North Ambazari Road, Near Ambazari Lake, Nagpur- 440033

DATA VALIDATION & VERIFICATION (DVV)

11	Trachi waghale	8767914118	<u>Waghale</u>	
12	Sufriya Patle	7757871925	<u>Patle</u>	
13	Atul Thakre	9881956597	<u>Thakre</u>	
14	Shreyash Chatter	8446350089	<u>Chatter</u>	
15	Tejas Chelmalwar	9604662119	<u>Chelmalwar</u>	
16	Bitam S. Khatke	8010793209	<u>Khatke</u>	
17	Surej M. Muthra	9730637023	<u>Muthra</u>	
18	Aniket J Bawankar	9767219301	<u>Bawankar</u>	
19	Madhura Bhondure	8767484914	<u>Bhondure</u>	
20	Rinam C Wankhede	8010966529	<u>Wankhede</u>	
21	Sejal D. Wankhede	7387990077	<u>Wankhede</u>	
22	Riya P. Raut	954698956	<u>Raut</u>	
23	Mansi Baghele	7703764468	<u>Baghele</u>	
24	Puneshwari F. Solwane	7249375539	<u>Solwane</u>	
25				

Signature of:

Programme In-charge

IQAC Coordinator

COORDINATOR

INTERNAL QUALITY ASSURANCE CELL
DHARAMPETH, M. P. DEO MEMORIAL &
SCIENCE COLLEGE, NAGPUR

Principal
PRINCIPAL

Dharampeth M.P. Deo Memorial
Science College, Nagpur-440033



DHARAMPETH M. P. DEO MEMORIAL SCIENCE COLLEGE,
North Ambazari Road, Near Ambazari Lake, Nagpur- 440033

DATA VALIDATION & VERIFICATION (DVV)

11	Kushal. M. Barapate	9175444778		
12	Aanya Kamgari	9890889506		
13	Ruunak Pashine	9309001343		RB
14	Somiksha Dengre	9096082939		
15	Shreyya Singh	7058423744		
16)	Sanchit S. Dengare	8657341501		Sanchit
17)	Jasraj D. Paliwal	9370820325		Jasraj
18)	Sameer V. Wagh	8830796088		
19)	Shrushti R. Nikule	7391881613		Srinule
20)	Shreshtha M. Bahuparkhi	8010248660		
21)	Neha V. Yadav	9011655444		Nyadav
22)	Aditya R. Yadav	7447744955		
24)	Abhijit S. Pant	9607185579		

Signature of:

Programme In-charge

CO ORDINATOR

ICAC COORDINATOR
DHARAMPETH, M. P. DEO MEMORIAL &
SCIENCE COLLEGE, NAGPUR

Principal
PRINCIPAL

Dharampeth M.P. Deo Memorial
Science College, Nagpur-440033



DHARAMPETH M. P. DEO MEMORIAL SCIENCE COLLEGE,
North Ambazari Road, Near Ambazari Lake, Nagpur- 440033

DATA VALIDATION & VERIFICATION (DVV)

25	Bhumika chedye	8830391103		
26	Shreyash Chatte	8446354089		
27	Atul Thakre	3881956597		
28	Paras chopade	785037689		
29	Rohan Shiravkar	8329359221		
20	Ayush Wakhare	8767695911		

Signature of:

Programme In-charge

COORDINATOR
IQAC Coordinator
INTERNAL QUALITY ASSURANCE CELL
DHARAMPETH, M. P. DEO MEMORIAL &
SCIENCE COLLEGE, NAGPUR

PRINCIPAL

Dharampeth M.P. Deo Memorial
Science College, Nagpur-440033



DHARAMPETH M. P. DEO MEMORIAL SCIENCE COLLEGE,
North Ambazari Road, Near Ambazari Lake, Nagpur- 440033

DATA VALIDATION & VERIFICATION (DVV)

Name of the Programme : Chemistry Model & Chart exhibition
 Date of the Programme : 4/10/2022
 Name of Chief Guest if any : -
 Name of Guest Speaker if any : -

Sr. No.	Name of the Participant	Mobile Number	E-mail Id	Signature
1)	Ishwan Suryawarshi	8087317297	suryawarshiishwan@gmail.com	<u>Ishwan</u>
2)	Vishal Kumar Singh	9610187223	singhvisal9601@gmail.com	<u>Vishal</u>
3)	Saurabh K. Shukla	7721802705	shukra_saurabh77@gmail.com	Saurabh
4)	Akash Shikole	9175422051	akash.akash15@gmail.com	<u>Akash</u>
5)	Ashuman Sharma	9370892462	ashuman.sharma314@gmail.com	<u>Ashuman</u>
6)	Chetan T Kanthe	9637271601	kanthechetan06@gmail.com	<u>Chetan</u>
7)	Mranali Sen Sore	9850163812	senanuranali16@gmail.com	<u>Mranali</u>
8)	Neha Waghade	7249895144	nehawaghade16022003@gmail.com	<u>Neha</u>
9)	Nikhil Hainkhede	9561179324	hainkhedevijay@gmail.com	<u>Nikhil</u>
10)	Vaishnavi Chandekar	7249882964	Vaishnavi.Chandekar.000@gmail.com	<u>Chandekar</u>

Signature of:

[Signature]

Programme In-charge

IQAC Coordinator

CO ORDINATOR

**INTERNAL QUALITY ASSURANCE CELL
DHARAMPETH, M. P. DEO MEMORIAL &
SCIENCE COLLEGE, NAGPUR**

Principal

PRINCIPAL
Dharampeth M.P. Deo Memorial
Science College, Nagpur-440035



DHARAMPETH M. P. DEO MEMORIAL SCIENCE COLLEGE,
North Ambazari Road, Near Ambazari Lake, Nagpur- 440033

DATA VALIDATION & VERIFICATION (DVV)

10]	Megha Fulwar	8605339608	meghafulwar@gmail.com	@Fulwar
11]	Suhriya Patle	7757871925	PatleSuhriya012@gmail.com	Patle
12]	Rakhi. P. Gadam	7378312504	gedamrakhi2000@gmail.com	Rakhi
13]	Rani. Kartcoale	9011247098	hkarani8112@gmail.com	Rani
14]	Pranjali N. Galkwad	9130893362	galkwadpranjali89@gmail.com	@galkwad
15]	Nidhi R. Bhatnagar	7972613061	nidhibhatnagar2020@gmail.com	Nidhi
16]	Janvika R. Dadi	376692740	janvikadadi12@gmail.com	Radi
17]	Anjali N. Chavde	8261964188	anjalicavde2001@gmail.com	Alhande
18]				

Signature of:

Programme In-charge

CO ORDINATOR

INTERNAL QUALITY ASSURANCE CELL
DHARAMPETH, M. P. DEO MEMORIAL &
SCIENCE COLLEGE, NAGPUR

PRINCIPAL

Dharampeth M. P. Deo Memorial
Science College, Nagpur-440033



DHARAMPETH M. P. DEO MEMORIAL SCIENCE COLLEGE,
North Ambazari Road, Near Ambazari Lake, Nagpur- 440013

DATA VALIDATION & VERIFICATION (DVV)

Name of the Programme : Chemistry Model & Chart exhibition
Date of the Programme : 4/10/2022
Name of Chief Guest if any : -
Name of Guest Speaker If any : -

Sr. No.	Name of the Participant	Mobile Number	E-mail Id	Signature
21.	Subbu R.K. Mishra	9860436418	subbumishra03234@gmail.com	<u>Subbu</u>
22	Vaishali S. Patil	9322600647	vaishalipatil179@gmail.com	<u>Patil</u>
23	Asmita D. Charijan	7387005732	asmitacharijan25@gmail.com	<u>Charijan</u>
24	Ashlesha Sangole	9509998469	Ashlesha.sangole99@gmail.com	<u>Sangole</u>
25	Janani Raghoe	7263819173	jananiraghoe@gmail.com	<u>Raghoe</u>
26	Nikhil R. Raut	9022680159	rautn.r.551@gmail.com	<u>Raut</u>
27	Milsh D. Hulke	8624091652	hulkenilosh@gmail.com	<u>Hulke</u>
28	Aditya C. Dewlkar	9028915776	adityadewlkar27@gmail.com	<u>Dewlkar</u>
29	Harshad. Warethi	86595124056	harshadwarethi@gmail.com	<u>Warethi</u>
30	Dinesh. Parlethi	9623389676	Parlethidinesh51@gmail.com	<u>Parlethi</u>

Signature of:

[Signature]
Programme In-charge

[Signature]
CO ORDINATOR
INTERNAL QUALITY ASSURANCE CELL
DHARAMPETH M. P. DEO MEMORIAL
SCIENCE COLLEGE, NAGPUR

[Signature]
Principal
DHARAMPETH M. P. DEO MEMORIAL
SCIENCE COLLEGE, NAGPUR-440037



DHARAMPETH M. P. DEO MEMORIAL SCIENCE COLLEGE,
North Ambazari Road, Near Ambazari Lake, Nagpur- 440033

DATA VALIDATION & VERIFICATION (DVV)

Name of the Programme : Chemistry Model & Chart exhibition.
Date of the Programme : 04/10/22
Name of Chief Guest if any : _____
Name of Guest Speaker if any : _____

Sr. No.	Name of the Participant	Mobile Number	E-mail Id	Signature
31.	Jagruiti A. Rawat	9265818046	Jagruiti.jitrawat55@gmail.com	
32.	Devashri. D. Ben.	8698119078	DevBen24@gmail.com	
33	Nikita .S. Barapatre	7058625053	nikitabarapatre25@gmail.com	
34	Shreyash Chatter	8446354089	Chatteshreyash2001@gmail.com	
35	Payanshu Chandra	9579257295	payanshuchandra00@gmail.com	
36	Muskan Yadav	9579492617	muskanyadav1225@gmail.com	
37	Abhishek Dalibhatore.	8208302902	abhishek.dalibhatore26@gmail.com	
38	AJUSH A. RADAM	9763013263	AK2855036@gmail.com	
39.	Sakshi Meshram	9145355733.	Sakshimeshram210@gmail.com	
40.	Mansi Mate	8468891807	mansim182@gmail.com	

Signature of:

Programme in-charge

CO ORDINATOR
IQAC Co-ordinator
INTERNAL QUALITY ASSURANCE CELL,
DHARAMPETH, M. P. DEO MEMORIAL &
SCIENCE COLLEGE, NAGPUR.

PRINCIPAL
Principal
Dharampeth M.P. Deo Memorial
Science College, Nagpur-440033



DHARAMPE H. M. P. DEO MEMORIAL SCIENCE COLLEGE,
North Ambazari Road, Near Ambazari Lake, Nagpur - 440033

DATA VALIDATION & VERIFICATION (DV)

Name of the Programme : Chemistry Model & chart exhibition
Date of the Programme : 4/10/2022
Name of Chief Guest if any : _____
Name of Guest Speaker if any : _____

Sr. No.	Name of the Participant	Mobile Number	E-mail Id	Signature
41.	Jyoti J. Sharma	8669736880	jyotise290@gmail.com	T. Sharma
42.	Siddharth G. Hiskane	9579092031	siddharthhiskane@gmail.com	Siddharth
43.	Sania Midhat A. Kaya	8775726700	midhatsania@gmail.com	Olase
44.	Vaishnavi Jansada Bedade	8657188093	vaishnavibedade@gmail.com	Bedade
45.	AMAN ANIL DONGRE	7709217312	amandongre2003@gmail.com	Dongre
46.	Shyamal D. Nasre	9765923998	shyamalnare@gmail.com	Nasre
47.	Vaibhav A. Malewar	8767838219	Vaibhavamalewar@gmail.com	Malewar
48.	Pradumn A. Singh	7666939990	hardhsingh.pillayevu	Singh
49.	Kaushik Mishra	9657199261		Mishra
50.	Surebhi Pradhe	7887076628	Surebhipradhe@gmail.com	Pradhe

Signature of:

Programme In-charge

CO ORDINATOR
IQAC COORDINATOR
INTERNAL QUALITY ASSURANCE CELL
DHARAMPE, M. P. DEO MEMORIAL

PRINCIPAL
Dharampe H. M. P. Deo Memorial
Science College, Nagpur-440033



NEP Activity Report

Date: 11/10/ 2022

Name of Organizing Department or Committee: Chemistry

Name of the activity: NEP Activity (SEM III -PAPER-2-UNIT-3)

Suggested CRITERION point if any: Criteria -II

Date of Activity: 04/10/2022

Place of Activity: Chemistry Department

Name of Guest Speaker/s or Judge/s or Chief Guest/s if any: Nil

Title of the Activity: Preparation of Tollens reagents /Uses of Chloroform in day today life-
(Chart preparation)

Number of Participants: 44

Name of the Teacher In-charge / Convener - Dr Tanishq Chaudhari

Names of other Committee Members / Staff:- Dr. V.P. Meshram

OUTCOME of the Activity with respect to mission vision of the institute and or academics:

Students came to know the uses of chloroform as anaesthesia, drug, solvent for floor polish laboratory reagent etc

Activity with newspaper coverage if any: Nil

Activity data save in PC of: Department of Chemistry

Note: Kindly share geotag photographs separately along with report on igacdsc2022@gmail.com



Prof. Pitambar Humane
CO-ORDINATOR
INTERNAL QUALITY ASSURANCE CELL
DHARAMPETH, M. P. DEO MEMORIAL &
SCIENCE COLLEGE, NAGPUR

Name & Signature of Teacher In-charge
(Dr. T. Chaudhari)

Dr. Akhlesh Peshwe
Principal
PRINCIPAL

Dharampeth M.P. Deo Memorial
Science College, Nagpur-440033



DHARAMPETH M. P. DEO MEMORIAL SCIENCE COLLEGE,
North Ambazari Road, Near Ambazari Lake, Nagpur- 440033

DATA VALIDATION & VERIFICATION (DVV)

Activity - 2 on Unit - 2
Name of the Programme : Preparation of Tollen's reagent/Uses of Chloroform
Date of the Programme : 4/10/2022
Name of Chief Guest if any : -
Name of Guest Speaker if any : -

Sr. No.	Name of the Participant	Mobile Number	E-mail Id	Signature
1	Shikha J. Yadav	7263881320	Shikhayadav@gmail.com	S J Yadav
2	Vaishali S. Pathe	9522600647	Vaishalipathe179@gmail.com	Pathe..
3	Varsha R. Tiwari	8408037438	varshatiwari@gmail.com	Varsha
4	Sushma G. Gurnale	9156235147	Sushmagurnale2@gmail.com	Gurnale
5	Siddhanta G. Niskanc	9579092931	hiderasankhantw1234@gmail.com	Siddhanta
6	Kalpna D. Sahagpure	9579236712	kalpanasahagpure@gmail.com	K Sahagpure
7	Sudhanshu Vitkey	7028429173	sudhanshuganali@gmail.com	Sudhanshu
8	Tejas Rewade	7796027056	Tejasrewade86@gmail.com	Tejas
9	Jagruiti Rawat	9265818046	JagruitiRawat@gmail.com	J Rawat
10	Ankita Mishra	8421295176	mishraankita9468@gmail.com	A Mishra

Signature of:

Programme In-charge

COORDINATOR
INTERNAL QUALITY ASSURANCE CELL
DHARAMPETH, M. P. DEO MEMORIAL &
SCIENCE COLLEGE, NAGPUR

Principal
PRINCIPAL
Dharampeth M.P. Deo Memorial
Science College, Nagpur-440033



DHARAMPETH M. P. DEO MEMORIAL SCIENCE COLLEGE,
North Ambazari Road, Near Ambazari Lake, Nagpur- 440033

DATA VALIDATION & VERIFICATION (DVV)

Sl. No.	Name	Mobile No.	Email id	Signature
11	Chhakuli G. Wadikar	9325047907	chhkuwadikar@gmail.com	
12	Vaishnavi .R. Lakhe	8669594864	chhakuli.lakhe36@gmail.com	
13	Mansi D. Raut	7385114931	Mansiraut451@gmail.com	
14	Twinkal G. Lokhande	8149176609	twinkalokhande@14@gmail.com	
15	Tina G. Rahangdale	9921776769	tinarahangdale@gmail.com	
16	Uamila V. Bhande	9370673867	bhandesumila.2000@gmail.com	
17	Vaibhavi A. Shande	8080640782	vaibhavisshandes9@gmail.com	
18	Vaishnavi Nandhure	9922489316	VaishnaviNandhure@gmail.com	
19	Prajwal S. Bhojare	8010434634	Prajwalb738@gmail.com	
20	Niket Thatre	7328899087	niketthatre92	
21	Rupesh Bholare	9834184621	rupeshbholare	

Signature of:

Programme In-charge

COORDINATOR
INTERNAL QUALITY ASSURANCE CELL
DHARAMPETH, M. P. DEO MEMORIAL &
SCIENCE COLLEGE, NAGPUR

PRINCIPAL
Dharampeth M.P. Deo Memorial
Science College, Nagpur-440033



DHARAMPETH M. P. DEO MEMORIAL SCIENCE COLLEGE,
North Ambazari Road, Near Ambazari Lake, Nagpur- 440033

DATA VALIDATION & VERIFICATION (DVV)

Name of the Programme : Preparation of Tollen's Reagent / uses of Chloroform
Date of the Programme : 4/10/2022
Name of Chief Guest if any : -
Name of Guest Speaker if any : -

Sr. No.	Name of the Participant	Mobile Number	E-mail Id	Signature
22	Apurva S. Verulkar	9623613911	apurva.verulkar@gmail.com	
23	Ruchika N. Patle	8669335907	ruchikapatle4@gmail.com	
24	Ashmit V. Juvon	8080238101	ashmitjuvone@gmail.com	
25	Bhumika V. Thakre	7218247917	Bhumikatthakre@gmail.com	
26	Varsha R. Tilhari	8408037938	Varshatilhari@gmail.com	
27	Sushma G. Gurnule	9156238747	sushmagurnule@gmail.com	
28	Pragwal B. Bhoyar	8010434634	Pragwalb738@gmail.com	
29	Niket Thakre	7373399072	niketthakre	
30	Rupesh Bhukre	9934184511	bhukre.rupesh	

Signature of:

Programme In-charge

COORDINATOR
INTERNAL QUALITY ASSURANCE CELL
DHARAMPETH, M. P. DEO MEMORIAL &
SCIENCE COLLEGE, NAGPUR

Principal

PRINCIPAL

Dharampeth M.P. Deo Memorial
Science College, Nagpur-440033



DHARAMPETH M. P. DEO MEMORIAL SCIENCE COLLEGE,
North Ambazari Road, Near Ambazari Lake, Nagpur- 440033

DATA VALIDATION & VERIFICATION (DVV)

Name of the Programme : Preparation of Tollen's reagent / uses of chloroform
Date of the Programme : 4/10/2022
Name of Chief Guest if any : -
Name of Guest Speaker if any : -

Sr. No.	Name of the Participant	Mobile Number	E-mail Id	Signature
1.	Siddhanta G. Huskane	9579092931	hbkansidhanta1234@gmail.com	
2.	Niket Y. Thakre	7378899087	niketthakre82@a---	
3.	Rupesh. Bhokse	9834184621	bhokserupesh5@a---	
4.	Prayansh S. Bhojra	8010424634	Prayanshb738@gmail.com	
5.	Tina G. Rahangdale	9921776769	tinahangdale@gmail.com	
6.	Chhakuli G. Wadikar	9325047907	chhakuwadikar@gmail.com	
7.	Vaishnavi. R. Lakhe	8669594864	chhakuwadikar@gmail.com	
8.	Mansi. D. Raut	7385114931	mansiraut@gmail.com	
9.	Twinkal G. Lohhande	8149176609	twinkallohhande314@gmail.com	
10.	Urmila V. Bondre	9870673867	bondreurmila2000@gmail.com	
11.	Vaishnavi Nandpure	9834184621	vaishnavi6a---	
12.	Valbhavi Shende	8080640782	Valbhavishende37@gmail	
13.	Niket Thakre	7372899087	niketthakre92a---	
14.	Rupesh Bhokse	9834184621		

Signature of:
Programme in-charge

IQAC Coordinator
CO ORDINATOR
INTERNAL QUALITY ASSURANCE CELL
DHARAMPETH, M. P. DEO MEMORIAL &
SCIENCE COLLEGE, NAGPUR

Principal
PRINCIPAL
Dharampeth M.P. Deo Memorial
Science College, Nagpur-440033



DHARAMPETH M. P. DEO MEMORIAL SCIENCE COLLEGE, NAGPUR
INTERNAL QUALITY ASSURANCE CELL (IQAC)

NEP Activity Report

Date: 11/10/2022

Name of Organizing Department or Committee: Chemistry

Name of the activity: NEP Activity (SEM III -PAPER-I:-UNIT-II)

Suggested CRITERION point if any: Criteria -II

Date of Activity: 04/10/2022

Place of Activity: Chemistry Department-

Name of Guest Speaker/s or Judge/s or Chief Guest/s if any- Nil

Title of the Activity: Poster of Periodic table

Number of Participants: 31

Name of the Teacher In-charge / Convener -Dr. Tanishq Chaudhari

Names of other Committee Members / Staff: - Dr. V.P. Meshram

OUTCOME of the Activity with respect to mission vision of the institute and or academics:

This is a student's centric activity. Students can visually understand the position of elements and properties of different periods and groups. This chart visually clears the concept of students about different elements.

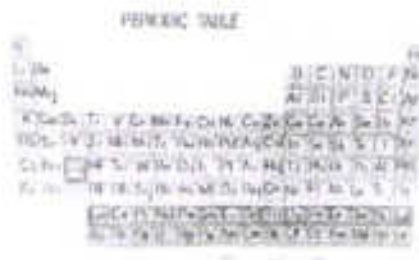

Activity with newspaper coverage if any: Nil

Activity data save in PC of: Department of Chemistry

Note: Kindly share geotag photographs separately along with report on iqacds2022@gmail.com

Prof. Pitambar Humane

IQAC Coordinator

COORDINATOR
INTERNAL QUALITY ASSURANCE CELL
DHARAMPETH, M. P. DEO MEMORIAL &
SCIENCE COLLEGE, NAGPUR

Name & Signature of Teacher In-charge
(Dr. T. Chaudhari).

Dr. Akhilesh Peshwe
Principal



DHARAMPETH M. P. DEO MEMORIAL SCIENCE COLLEGE,
North Ambazari Road, Near Ambazari Lake, Nagpur- 440033

DATA VALIDATION & VERIFICATION (DVV)

Name of the Programme : NEP (Poster of periodic table) (sem-III, paper I, unit-II)
Date of the Programme : 4/10/2022
Name of Chief Guest if any : _____
Name of Guest Speaker if any : _____

Sr. No.	Name of the Participant	Mobile Number	E-mail Id	Signature
1.	Surbhi Pardhe	77 845 67 891	surbhipardhe@gmail.com	
2.	Teja Rewade	92 644 58 781	tejarrewade@gmail.com	
3.	Chhakuli Kadikar	911 511 7117	chhakulikadikar@gmail.com	
4.	Vaishnavi R. Manpure	813 45 76 891	vaishnavi36@gmail.com	
5.	Shreyas Dhawale	866 9777 890	sdhawale@gmail.com	
6.	Rupesh Bhoke	97 245 78 901	rupeshbhoke@gmail.com	
7.	Pooja Itankar	921 345 78 91	poojai@gmail.com	
8.	Manvi Raut	812 14 57 890	manvi@gmail.com	
9.	Dhanashree Nawalkar	9024 57 9011	dhana@gmail.com	
10.	Rohit Parate	81 345 76 891	rohitparate@gmail.com	

Signature of

Programme In-charge

IQAC Coordinator
CO ORDINATOR
INTERNAL QUALITY ASSURANCE CELL
DHARAMPETH, M. P. DEO MEMORIAL &
SCIENCE COLLEGE, NAGPUR

Principal
PRINCIPAL
Dharampeth M.P. Deo Memorial
Science College, Nagpur-440033



DHARAMPETH M. P. DEO MEMORIAL SCIENCE COLLEGE,
North Ambazari Road, Near Ambazari Lake, Nagpur- 440033

DATA VALIDATION & VERIFICATION (DVV)

11	Jasraj Detral Patil	9370820325	jasrajpatil47@gmail.com	Jasraj Patil
12	Kalpna D. Suhagpure	9579236712	kalpnasuhagpure@gmail.com	Kalpna Suhagpure
13	Tina. G. Rahangdale	9991776769	tinarahangdale@gmail.com	Tinarahangdale
14	Siddharth G. Hiskane	9579092931	hiskane.siddharth1234@gmail.com	Siddharth Hiskane
15	Vaishnavi R. Lakhe	8669594864	chhakuli.lakhe56@gmail.com	Vaishnavi Lakhe
16	Chhakuli G. Wadikar	9325047907	chhakuli.wadikar@gmail.com	Chhakuli Wadikar
17	Prajwal S. Bhojare	8010434634	Prajwalb738@gmail.com	Prajwal Bhojare
18	Jyoti J. Sharma	8669736380	jyoti's 5390@gmail.com	Jyoti Sharma
19	Nrupesh M. Sharma	9322042259	nrupeshsharma255@gmail.com	Nrupesh Sharma
20	AMAN ANIL DONGRE	7709217312	amandongre2000@gmail.com	Amang Dongre
21	Sania A. Roy	8975726700	midhaternia@gmail.com	Sania Roy
22	Nikita J. Kallo	9067324988	kallanikita54@gmail.com	Nikita Kallo
23	Sakshi S. Meshram	9145855483	sakshimeshram210@gmail.com	Sakshi Meshram
24	Kajal P. Nighat	9373250629	kajalnighat2000@gmail.com	Kajal Nighat
25	Juhi S. Chaudhari	8669248944	chaudharijuhi110@gmail.com	Juhi Chaudhari
26	Mansi I. Mall	9468891807	mansi19182@gmail.com	Mansi Mall
27	Urnita V. Bondre	9370673867	bondrevrnita_2000@gmail.com	Urnita Bondre
28	Shravya Athawade	8888264004	shrayathawade_124@gmail.com	Shravya Athawade
29	Vaibhavi Shende	9080840782	vaibhavisshende87@gmail.com	Vaibhavi Shende
30	Gargi I. Wadge	7972076671	gargiwadge@gmail.com	Gargi Wadge
31	Kajal P. Wadad	8765421911	kajalw@gmail.com	Kajal Wadad

Signature of:
Programme In-charge
Tamisk

INTERNAL QUALITY ASSURANCE CELL
DHARAMPETH, M. P. DEO MEMORIAL &
SCIENCE COLLEGE, NAGPUR

Principal
[Signature]
PRINCIPAL
Dharampeth M.P. Deo Memorial
Science College, Nagpur-440033



DHARAMPETH M. P. DEO MEMORIAL SCIENCE COLLEGE, NAGPUR
INTERNAL QUALITY ASSURANCE CELL (IQAC)
NEP Activity Report

Date: 8/10/23

Name of Organizing Department or Committee: Department of Chemistry

Name of the activity: NEP Activity B.Sc. Sem V Unit 1

Suggested CRITERION point if any: Criteria II

Date of Activity: 04/10/22

Place of Activity: Chemistry lab. 3rd floor

Name of Guest Speaker/s or Judge/s or Chief Guest/s if any: Nil

Title of the Activity: Demonstration of different derivatives of different compounds and its applications.

Number of Participants: 47

Name of the Teacher In-charge / Convener: Dr. Sandip Madhukar Bhiwagade

Names of other Committee Members / Staff: Dr. Vaishali P. Meshram

OUTCOME of the Activity with respect to mission vision of the institute and or academics:

This is student centric activity. This activity helps to understand students how to synthesize derivative of given organic compound. In this activity student learn and synthesize benzene diazonium salt derivative of amine compound which is then converted into dye. In this activity student learns about the derivative preparation of organic compound and its uses.

Activity with newspaper coverage if any : Nil

Activity data save in PC of: Department of Chemistry



Prof. Pitambar Humane

IQAC Coordinator

CO ORDINATOR

INTERNAL QUALITY ASSURANCE CELL
DHARAMPETH, M. P. DEO MEMORIAL &
SCIENCE COLLEGE, NAGPUR

Dr. Sandip Bhiwagade
Bhiwagade

Name & Signature of Teacher In-charge

Dr. Akhilesh Peshwe

Principal

PRINCIPAL

Dharampeth M.P. Deo Memorial
Science College, Nagpur-440023



DHARAMPETH M. P. DEO MEMORIAL SCIENCE COLLEGE,
North Ambazari Road, Near Ambazari Lake, Nagpur- 440033

Date: 4/10/22

DATA VALIDATION & VERIFICATION (DVV)

Name of the Programme : NEP Activity (Preparation of AZO dye) / demonstration of different derivatives of different comp. & its application.

Date of the Programme : 4/10/22

Name of Chief Guest if any : _____

Name of Guest Speaker if any : _____

Sr. No.	Name of the Participant	Mobile Number	E-mail Id	Signature
1	Amit warde	9302900209	walde.102202@gmail.com	
2	Ashish Nandedo warde	7972190515	ashishnandedo@gmail.com	
3	Damini Bhandbuche	9356413802	bhandbuche200@gmail.com	D. Bhandbuche
4	HARSHAD KHARDE	9021019101	harshadkharde@gmail.com	Harshad
5	Nikita Pund	9579643389	vandnikita5@gmail.com	
6	Prachi Warbhadhe	7517090406	warbhadhe2020@gmail.com	Prachi Warbhadhe
7	Aarati Bisen	8605399606	BisenA87@gmail.com	Aarati Bisen
8	Aditi Tike	9850163812	adititike123@gmail.com	
9	Shruti Pawar	8275105785	pawarshruti9877@gmail.com	Shruti
10	Suhani Indurkar	7378812502	suhaniindurkar@gmail.com	Indurkar

Signature of:
Programme In-charge

IAC COORDINATOR
INTERNAL QUALITY ASSURANCE CELL
DHARAMPETH, M. P. DEO MEMORIAL &
SCIENCE COLLEGE, NAGPUR

Principal
PRINCIPAL
Dharampeth M.P. Deo Memorial
Science Coll. Nagpur-440033



DHARAMPETH M. P. DEO MEMORIAL SCIENCE COLLEGE,
North Ambazari Road, Near Ambazari Lake, Nagpur- 440033

DATA VALIDATION & VERIFICATION (DVV)

11.	Krushnali Sanjay Kadam	8625854995	krushnalikadam67@gmail.com	Kadam
12.	Bhumnika Devendra Chedde	8830891103	bhumnikachedde@gmail.com	Chedde
13.	Poojari Laxmikant Dandekar	9325673318	dandekarpoorjari16@gmail.com	Dandekar
14.	Astha Abhay Sakharwade	9405197842	asthasakhar@gmail.com	Sakharwade
15.	Avanti Ashish Chaphekar	7825173847	avanti1011@gmail.com	Avanti
16.	Anjali Namdeo Chasde	8261964188	anjalicbasde20@gmail.com	Chasde
17.	Ayushi D. Shukla	9373668043	ayushishukla28112002@gmail.com	Shukla
18.	Krushika D. Aundhkar	8767279513	krushikaundhkar652@gmail.com	Krushika
19.	Raksha Dhote	7498511875	rakshadhote3@gmail.com	Dhote
20.	Pallavi Bhagat	9022654940	pallavi2208@gmail.com	Bhagat
21.	Priyanshi Singh	7219259020	priyanshisingh18040@gmail.com	Singh
22.	Chaitali M. Burebade	9359540394	chaitali20206@gmail.com	Chaitali
23.	Anushka D. Desai	7058933157	ad04092001@gmail.com	Desai
24.	Tanushree R. Dadi	9766927406	tanushreedadi@gmail.com	Dadi
25.	Sakshi Surendra Moon	7745827736	sakshim3030@gmail.com	Moon
26.	Muskan H. Sheikh	8055474633	Muskan2019sss@gmail.com	Sheikh

Signature of:

Programme In-charge

CO-ORDINATOR
IQAC COORDINATOR, QUALITY ASSURANCE CELL
DHARAMPETH, M. P. DEO MEMORIAL &
SCIENCE COLLEGE, NAGPUR

Principal
PRINCIPAL
Dharampeth M.P. Deo Memorial
Science College, Nagpur-440033

27.	SHIVANI BHUTE	9302900209	Bhuteshivani@gmail.com	<u>Shivani</u>
28.	VIKITA EKRE	7972190515	EksaVikita02@gmail.com	<u>Nikita</u>
29.	Sayli S. Lokhande	9356413804	Sayalilokhande@gmail.com	<u>Lokhande</u>
30.	Nikita D. Shebe	9021019101	nikita.shebe2019@gmail.com	<u>Shebe</u>
31.	Aachal S. Wagh	9574643389	aachalwagh2003@gmail.com	<u>Wagh</u>
32.	Saumiksha Choudhary	7517090406	choudharysaumiksha26@gmail.com	<u>Stry</u>
33.	Vaishnavi Chandekar	7249882964	Vaishnavichandekar000@gmail.com	<u>Chandekar</u>
34.	Megha S. Fulwar	8605399606	Mfulwar@gmail.com	
35.	Meunali R. Songare	9850163812	songaremeunali16@gmail.com	<u>RSongare</u>
36.	Neha A. Waghade	7249895144	nehawaghade16082002@gmail.com	<u>Waghade</u>
37.	Damini M. Bardbuche	8275105785	bardbuchedamini@gmail.com	<u>D. Bardbuche</u>
38.	Rakhi Gedam	7378312505	gedamrakhi2000@gmail.com	<u>R. Gedam</u>
39.	Prachi S. Waghale	8767914118	Prachiwaghale11@gmail.com	<u>Waghale</u>
40.	Pragya R. Jha	9665852975	pragya1687687@gmail.com	<u>Jha</u>
41.	Akanksha R. Yeluge	8767935524	akankshayeluge@gmail.com	<u>Akanksha</u>
42.	Vedika P. Karankar	9145149787	vedikakarankar@gmail.com	<u>VK</u>
43.	Roji N. Pathan	8669398198	Rojikhan66024@gmail.com	<u>R. Pathan</u>
44.	Nikita R. Rahangdale	9307723308	nikitastahangdale2005@gmail.com	<u>Rahangdale</u>
45.	Divya T. Bondre	8668454925	divyabondre2@gmail.com	<u>Divya</u>
46.	Suhanya Patle	7757871925	PatleSuhanya123@gmail.com	<u>Patle</u>
47.	Snehal A. Bute	7058756570	snehalbute7218@gmail.com	<u>Sbute</u>



DHARAMPETH M. P. DEO MEMORIAL SCIENCE COLLEGE, NAGPUR
INTERNAL QUALITY ASSURANCE CELL (IQAC)

Activity Report

Date: 07/10/2022

Name of Organizing Department or Committee: Microbiology Department

Name of the activity: Visit to Indira Gandhi Rugnalaya and Arpan Blood Bank

Suggested CRITERION point if any: Criterion II

Date of Activity: 7th October 2022 and 8th Oct 2022

Place of Activity: Indira Gandhi Rugnalaya and Arpan Blood Bank

Name of Guest Speaker/s or Judge/s or Chief Guest/s if any: Guest Speaker- Nil

Title of the Activity: Demonstration of Acid-Fast Staining and PCR Technique for diagnosis of TB

Number of Participants: 37 students of Sem V

Name of the Teacher In-charge / Convener: Dr. Vidya R. Kathoke

Names of other Committee Members / Staff: Dr. Pratiksha Pohekar and Diksha Zade

OUTCOME of the Activity with respect to mission vision of the institute and or academics:

1. It helps to create interest in the subject, also enhances practical knowledge about various communicable diseases like TB and its necessity of control in the society.
2. To enhance research aptitude and to address the queries of curious minds through communication with the medical officers.
3. They come to know about the importance of blood donation, and importance of various blood components, its separation methods and storage methods, through live demonstration.



Activity with newspaper coverage any:

Prof. Pitambar Humane
IQAC Coordinator

Dr. Vidya R. Kathoke
Name & Signature of Teacher In-charge

Dr. Akhilesh Peshwe
Principal

VISIT TO INDIRA GANDHI HOSPITAL FOR ACID FAST STAINING

PLACE:- INDIRA GANDHI HOSPITAL
DATE:-8TH OCTOBER 2022

Hospital visit was organized by Dr. Vidya kathoke Mam. The hospital visit started on time 10pm. We visited a hospital for acid fast staining and a blood bank room. First of all we saw the blood bank room. On the first floor we got the information about blood donation.

Hospitals offered their valuable services for blood donation. In blood Bank room Mam told that how the separate blood components like as plasma, WBCs, RBCs, platelets in Quality control room. we also got the information about blood donor and Recipient (patient). Blood donor Person should be age above 18+ and blood donor person should not be infected for the donation of blood. Before blood donation first of donor should be check B.P and diabetes and sugar test. Blood donor person (Girl) should have hemoglobin 15.

In the blood bank room we saw some machines such as Laminar flow in the refreshment room for patients. After visiting the blood bank room we visited a lab for Acid fast staining. We got information about Acid fast staining occurred in such type of microorganism which have waxy covering in bacterial cell. Due to this covering in bacterial cell Acid fast staining done.

This type of organism do not get decolorized By strong agent. In Acid fast staining some strong reagents into the bacterial cell First of all taken sputum of T.B. patient and made a smear on the slide. Reagents are used such as carbol fushion, H₂SO₄ acid, Methylene blue. In Acid fast staining

Mycobacterium colonies detected which is red coloured rod shape.

After that we visited the PCR Room where CBNAAT machines were available and in that machine cartridges contained sputum samples and were then placed in CBNAAT machines. CBNAAT machine connected with monitor

and shown the report about T.B. the patient. Machine required a high temperature in a cold room. Monitor displayed report of T.B. patient Negative then Rifampicin drug not given to the patient. If the report of

T.B. is positive i.e. person was infected with T.B. disease. this patient is diagnosed that the body resist Rifampicin or it was sensitized to it. If it resist Rifampicin then second line drugs was given for treatment. If it sensitized Rifampicin then 1st line drugs was given for treatment. Two types of patient T.B. patient. 1- pulmonary tract T.B. 2- Extra pulmonary tract TB for diagnosis, x-ray, gene -Expert PCR, True north and is Acid fast Staining is done. Two machines was used for diagnosis CABINET, True nert.

ADVANTAGES OF CABINET OVER TRUE NERT

- 1- There was no manual work carried out in CABINET. Whole process of testing is machine based.
- 2- It had good result accuracy as compared to True nert.

ADVANTAGE OF TRUE NERT OVER CABINET

- 1- CABINET required high temperature AC- Room and true nert was flexible in any temperature it can be shifted to any place for diagnosis and testing
- 2- CABINET was more expensive and true-nert was cheaped but less accuracy to result.

Reported by
Sadaf A. Sheikh
Suhani P. Indurkar
Manali S. Shinde
Nandini P. Pounikar

W. R. Kothake

P. U. R. Kothake
Head
DEPT. of Microbiology
M. S. S. Hospital
M. S. S. Hospital

DHARAMPETH EDUCATION SOCIETY'S
**DHARAMPETH M. P. DEO MEMORIAL
SCIENCE COLLEGE**

South Ambazari Road, Near Ambazari Lake, Nagpur-440033 (M.S.)
Ph. No. 0712-2241312/2241400 Fax: 2241125
Email: principal_dmpde@mail.com www.dharampethscience.com



Ref:

Date: 27/09/2022

To,
Medical Officer,
Indira Gandhi Rughalaya,
Nagpur

07/10/22 and 08/10/22

Subject: Visit to Indira Gandhi Hospital on dated 30/09/2022 and 01/10/2022.

Respected Sir,

As a part of curriculum for undergraduate students a visit to **Indira Gandhi hospital** is to be arranged at your institute for B.Sc. Part - III students on 30/09/2022 and 01/10/2022 at 12.30 pm. Total no. of students were 70 along with one teacher.

Therefore I request you to permit me for the same.

Thanking you

V. R. Kathoke
(Dr. Mrs. V. R. Kathoke)

Head
V. R. Kathoke
Head
Deptt. of Microbiology
Dharampeth MP Deo Memorial
Science College, Nagpur

Akhilesh Peshwe
Dr. Akhilesh Peshwe

Principal
Principal
Dharampeth M. P. Deo Memorial
Science College, Nagpur.

Slawh
28/9/22
Arpan Blood Center
Nagpur

MS MGR
28/9/22

PB staff available

on wards 5 meet. after 7h. Oct. so pls come at 10 am.



DHARAMPETH M. P. DEO MEMORIAL SCIENCE COLLEGE,
North Ambazari Road, Near Ambazari Lake, Nagpur- 440033

DATA VALIDATION & VERIFICATION (DVV)

Name of the Programme

: Visit to Hospital & Blood Bank

Date of the Programme

: 7th Oct 2022 & 8th Oct 2022

Name of Chief Guest if any

: _____

Name of Guest Speaker if any

: _____

Sr. No.	Name of the Participant	Mobile Number	E-mail Id	Signature
	Ayushi Shukla	9373668043	ayusheshukla28112002	
	Sagli S. Lokhande	9356413804	sagyalokhande2910@gmail.com	
	Samiksha N. Kundekar	9145253759	samikshakundekar@gmail.com	
	Rashmi M. Bambal	9325853408	Rashmi201816@gmail.com	
	Shiwani P.R. Dwivedi	8855900546	Shiwaniidwivedi@gmail.com	
	Krushnali S. Kade	8625854995	krushnalikade67@gmail.com	
	Bhumika D. Chedga	8830391103	bhumikachedga@gmail.com	

Signature of:

Programme In-charge

IQAC Coordinator

Principal
Principal, P. Deo Memorial
Science College, Nagpur



DATA VALIDATION & VERIFICATION (DVV)

	Amishi. S. Wele	8530778433	amshiswele@gmail.com	
	Madhura U. Bhandure	8767484914	madhuraubhandure@gmail.com	
	Anjali R. Pali	7498102109	palianjali46@gmail.com	
	Shreyansh S. Naikwar	7447844189	shreyanshnaikwar7@gmail.com	
	Rupesh W. Wadde	8329676611	Rupeshwadde780@gmail.com	
	Balraj M. Wadgaonkar	7420896682	Balrajwadgaonkar@gmail.com	
	Rishabh C. Wankhede	8010966523	wankhede.rishabh@gmail.com	

Signature of:

Programme In-charge

IQAC Coordinator

Principal



DHARAMPETH M. P. DEO MEMORIAL SCIENCE COLLEGE,
North Ambazari Road, Near Ambazari Lake, Nagpur- 440033

DATA VALIDATION & VERIFICATION (DVV)

1)	Laxmi Gaule	7758058514	laxmigaule2902@gmail.com	Laxmi Gaule
2)	Nandini Hodge	9370301679	nandinihodge17@gmail.com	Nandini
3)	Bhargavi Sambare	7709403806	bhargavisambare05@gmail.com	Bh.
4)	Shikha Thakre	8010907069	ishithakre22@gmail.com	Shikha
5)	Aishwarya Joshi	7498328662	aishwaryajoshi2005@gmail.com	Aishi
6)	Shruti Pawar	9521988107	shrutipawar0707@gmail.com	Shruti Pawar
7)	Tammy Chaudhary	8600102341	tammychaudhary3@gmail.com	Tammy
8)	Neha Chandratne	9156873192	nehachandratne346@gmail.com	Neha Chandratne
9)	Sadat Purven Sheikh	9673410401	sheikhsadat934@gmail.com	Sadat
10)	Suhani Indurkar	9370419064	suhaniindurkar990@gmail.com	Suhani
11)	Manali Shinde	7249637434	manalishinde002@gmail.com	Manali
12)	Asmiti Baboolal Bisen	8767549078	asmitibisen129@gmail.com	Asmiti
13)	Smriti M. Gaikwad	7385532705	smritigaikwad86935@gmail.com	Smriti Gaikwad
14)	Arkita R. Bhoyar	8788031173	arkitabhoyar06@gmail.com	Arkita
15)	Richelle N. Baradwaj	7972613061	richellebaradwaj@gmail.com	Richelle
16)	Manish S. Gunde	9370329857	manishgunde79@gmail.com	Manish

Signature of:

Kathake
Programme In-charge

IQAC Coordinator

Principal
Dharampeth M. P. Deo Memorial
Science College, Nagpur



NEP Activity Report

Date: 11/10/ 2022

Name of Organizing Department or Committee: Chemistry

Name of the activity: NEP Activity (SEM III -PAPER-2-UNIT-3)

Suggested CRITERION point if any: Criteria -II

Date of Activity: 04/10/2022

Place of Activity: Chemistry Department

Name of Guest Speaker/s or Judge/s or Chief Guest/s if any: Nil

Title of the Activity: Preparation of Tollens reagents /Uses of Chloroform in day today life-
(Chart preparation)

Number of Participants: 44

Name of the Teacher In-charge / Convener - Dr Tanishq Chaudhari

Names of other Committee Members / Staff:- Dr. V.P. Meshram

OUTCOME of the Activity with respect to mission vision of the institute and or academics:

Students came to know the uses of chloroform as anaesthesia, drug, solvent for floor polish laboratory reagent etc

Activity with newspaper coverage if any: Nil

Activity data save in PC of: Department of Chemistry

Note: Kindly share geotag photographs separately along with report on igacdsc2022@gmail.com



Prof. Pitambar Humane
CO-ORDINATOR
INTERNAL QUALITY ASSURANCE CELL
DHARAMPETH, M. P. DEO MEMORIAL &
SCIENCE COLLEGE, NAGPUR

Name & Signature of Teacher In-charge
(Dr. T. Chaudhari)

Dr. Akhilesh Peshwe
Principal
PRINCIPAL

Dharampeth M.P. Deo Memorial
Science College, Nagpur-440033



DHARAMPETH M. P. DEO MEMORIAL SCIENCE COLLEGE,
North Ambazari Road, Near Ambazari Lake, Nagpur- 440033

DATA VALIDATION & VERIFICATION (DVV)

Activity - 2 on Unit - 2
Name of the Programme : Preparation of Tollen's reagent/Uses of Chloroform
Date of the Programme : 4/10/2022
Name of Chief Guest if any : -
Name of Guest Speaker if any : -

Sr. No.	Name of the Participant	Mobile Number	E-mail Id	Signature
1	Shikha J. Yadav	7263881320	Shikhayadav@gmail.com	S J Yadav
2	Vaishali S. Pathe	9522600647	Vaishalipathe179@gmail.com	Pathe..
3	Varsha R. Tiwari	8408037438	varshatiwari@gmail.com	Varsha
4	Sushma G. Gurnale	9156235147	sushmagurnale2@gmail.com	Sushma
5	Siddhanta G. Niskanc	9579092931	hiderasankhantw1234@gmail.com	Siddhanta
6	Kalpna D. Sahagpure	9579236712	kalpanasahagpure@gmail.com	Kalpna
7	Sudhanshu Vitkey	7028429173	sudhanshuganali@gmail.com	Sudhanshu
8	Tejas Rewade	7796027056	Tejasrewade86@gmail.com	Tejas
9	Jagruiti Rawat	9265818046	JagruitiRawat@gmail.com	Jagruiti
10	Ankita Mishra	8421295176	mishraankita9468@gmail.com	Ankita

Signature of:

Programme In-charge

COORDINATOR
INTERNAL QUALITY ASSURANCE CELL
DHARAMPETH, M. P. DEO MEMORIAL &
SCIENCE COLLEGE, NAGPUR

Principal
PRINCIPAL
Dharampeth M.P. Deo Memorial
Science College, Nagpur-440033



DHARAMPETH M. P. DEO MEMORIAL SCIENCE COLLEGE,
North Ambazari Road, Near Ambazari Lake, Nagpur- 440033

DATA VALIDATION & VERIFICATION (DVV)

Sl. No.	Name	Mobile No.	Email id	Signature
11	Chhakuli G. Wadikar	9325047907	chhkuwadikar@gmail.com	
12	Vaishnavi .R. Lakhe	8669594864	chhakuli.lakhe36@gmail.com	
13	Mansi D. Raut	7385114931	Mansiraut451@gmail.com	
14	Twinkal G. Lokhande	8149176609	twinkalokhande@14@gmail.com	
15	Tina G. Rahangdale	9921776769	tinarahangdale@gmail.com	
16	Uamila V. Bhande	9370673867	bhandesumila.2000@gmail.com	
17	Vaibhavi A. Shande	8080640782	vaibhavisshandes9@gmail.com	
18	Vaishnavi Nandhure	9922489316	VaishnaviNandhure@gmail.com	
19	Poojaal .S. Bhojare	8010434634	Poojaalb738@gmail.com	
20	Niket Thatre	7328899087	niketthatre92	
21	Rupesh Bholare	9834184621	rupeshbholare	

Signature of:

Programme In-charge

COORDINATOR
INTERNAL QUALITY ASSURANCE CELL
DHARAMPETH, M. P. DEO MEMORIAL &
SCIENCE COLLEGE, NAGPUR

PRINCIPAL
Dharampeth M.P. Deo Memorial
Science College, Nagpur-440033



DHARAMPETH M. P. DEO MEMORIAL SCIENCE COLLEGE,
North Ambazari Road, Near Ambazari Lake, Nagpur- 440033

DATA VALIDATION & VERIFICATION (DVV)

Name of the Programme : Preparation of Tollen's Reagent / uses of Chloroform
Date of the Programme : 4/10/2022
Name of Chief Guest if any : -
Name of Guest Speaker if any : -

Sr. No.	Name of the Participant	Mobile Number	E-mail Id	Signature
22	Apurva S. Verulkar	9623613911	apurva.verulkar@gmail.com	
23	Ruchika N. Patle	8669335907	ruchikapatle4@gmail.com	
24	Ashmit V. Juvon	8080238101	ashmitjuvone@gmail.com	
25	Bhumika V. Thakre	7218247917	Bhumikathakre@gmail.com	
26	Varsha R. Tilhari	8408037938	Varshatilhari@gmail.com	
27	Sushma G. Gurusule	9156238747	sushmagurusule@gmail.com	
28	Pragwal B. Bhoyar	8010434634	Pragwalb738@gmail.com	
29	Niket Thakre	7373399072	niketthakre	
30	Rupesh Bhukre	9934184511	bhukre.rupesh	

Signature of:

Programme In-charge

COORDINATOR

INTERNAL QUALITY ASSURANCE CELL
DHARAMPETH, M. P. DEO MEMORIAL &
SCIENCE COLLEGE, NAGPUR

Principal

PRINCIPAL

Dharampeth M.P. Deo Memorial
Science College, Nagpur-440033



DHARAMPETH M. P. DEO MEMORIAL SCIENCE COLLEGE,
North Ambazari Road, Near Ambazari Lake, Nagpur- 440033

DATA VALIDATION & VERIFICATION (DVV)

Name of the Programme : Preparation of Tollen's reagent / uses of chloroform
Date of the Programme : 4/10/2022
Name of Chief Guest if any : -
Name of Guest Speaker if any : -

Sr. No.	Name of the Participant	Mobile Number	E-mail Id	Signature
1.	Siddhanta G. Huskane	9579092931	hbkansidhanta1234@gmail.com	
2.	Niket Y. Thakre	7378899087	niketthakre82@a---	
3.	Rupesh. Bhokse	9834184621	bhokserupesh5@a---	
4.	Prayansh S. Bhojra	9010424634	Prayanshb738@gmail.com	
5.	Tina G. Rahangdale	9921776769	tinahangdale@gmail.com	
6.	Chhakuli G. Wadikar	9325047907	chhakuwadikar@gmail.com	
7.	Vaishnavi. R. Lakhe	8669594864	chhakuwadikar@gmail.com	
8.	Mansi. D. Raut	7385114931	mansiraut@gmail.com	
9.	Twinkal G. Lohhande	8149176609	twinkalbhhande314@gmail.com	
10.	Urmila V. Bondre	9870673867	bondreurmila2000@gmail.com	
11.	Vaishnavi Nandpure	9834184621	vaishnavi6a---	
12.	Valbhavi Shende	8080640782	Valbhavishende37@gmail	
13.	Niket Thakre	7372899087	niketthakre92a---	
14.	Rupesh Bhokse	9834184621		

Signature of:
Programme in-charge

IQAC Coordinator
CO ORDINATOR

INTERNAL QUALITY ASSURANCE CELL
DHARAMPETH, M. P. DEO MEMORIAL &
SCIENCE COLLEGE, NAGPUR

Principal

PRINCIPAL

Dharampeth M.P. Deo Memorial
Science College, Nagpur-440033



DHARAMPETH M. P. DEO MEMORIAL SCIENCE COLLEGE, NAGPUR
INTERNAL QUALITY ASSURANCE CELL (IQAC)

NEP Activity Report

Date: 11/10/2022

Name of Organizing Department or Committee: Chemistry

Name of the activity: NEP Activity (SEM III -PAPER-I:-UNIT-II)

Suggested CRITERION point if any: Criteria -II

Date of Activity: 04/10/2022

Place of Activity: Chemistry Department-

Name of Guest Speaker/s or Judge/s or Chief Guest/s if any- Nil

Title of the Activity: Poster of Periodic table

Number of Participants: 31

Name of the Teacher In-charge / Convener -Dr. Tanishq Chaudhari

Names of other Committee Members / Staff: - Dr. V.P. Meshram

OUTCOME of the Activity with respect to mission vision of the institute and or academics:

This is a student's centric activity. Students can visually understand the position of elements and properties of different periods and groups. This chart visually clears the concept of students about different elements.

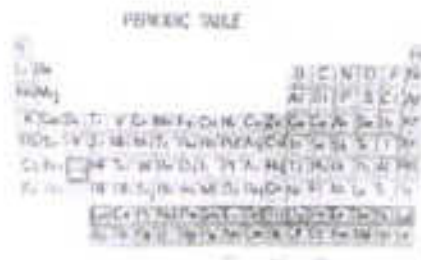

Activity with newspaper coverage if any: Nil

Activity data save in PC of: Department of Chemistry

Note: Kindly share geotag photographs separately along with report on iqacds2022@gmail.com

Prof. Pitambar Humane

IQAC Coordinator

COORDINATOR
INTERNAL QUALITY ASSURANCE CELL
DHARAMPETH, M. P. DEO MEMORIAL &
SCIENCE COLLEGE, NAGPUR

Name & Signature of Teacher, In-charge
(Dr. T. Chaudhari).

Dr. Akhilesh Peshwe
Principal



DHARAMPETH M. P. DEO MEMORIAL SCIENCE COLLEGE,
North Ambazari Road, Near Ambazari Lake, Nagpur- 440033

DATA VALIDATION & VERIFICATION (DVV)

Name of the Programme : NEP (Poster of periodic table) (sem-III, paper I, unit-II)
Date of the Programme : 4/10/2022
Name of Chief Guest if any : _____
Name of Guest Speaker if any : _____

Sr. No.	Name of the Participant	Mobile Number	E-mail Id	Signature
1.	Surbhi Pardhe	77 845 67 891	surbhipardhe@gmail.com	
2.	Teja Rewade	92 644 58 781	tejarrewade@gmail.com	
3.	Chhakul Madikar	911 511 7117	chhakulmadikar@gmail.com	
4.	Vaishnavi R. Manpure	813 45 76 891	vaishnavi36@gmail.com	
5.	Shrey Dhawale	866 9777 890	sdhawale@gmail.com	
6.	Rupesh Bhole	97 245 78 901	rupeshbhole@gmail.com	
7.	Pooja Itankar	921 345 78 91	poojai@gmail.com	
8.	Manvi Raut	812 14 57 890	manvi@gmail.com	
9.	Dhanashree Nawalkar	9024 57 9011	dhana@gmail.com	
10.	Rohit Parate	81 345 76 891	rohitparate@gmail.com	

Signature of

Programme In-charge

IQAC Coordinator
CO ORDINATOR
INTERNAL QUALITY ASSURANCE CELL
DHARAMPETH, M. P. DEO MEMORIAL &
SCIENCE COLLEGE, NAGPUR

Principal
PRINCIPAL
Dharampeth M.P. Deo Memorial
Science College, Nagpur-440033



DHARAMPETH M. P. DEO MEMORIAL SCIENCE COLLEGE,
North Ambazari Road, Near Ambazari Lake, Nagpur- 440033

DATA VALIDATION & VERIFICATION (DVV)

11	Jasraj Detral Patil	9370820325	jasrajpatil47@gmail.com	Jasraj Patil
12	Kalpna D. Suhagpure	9579236712	kalpnasuhagpure@gmail.com	Kalpna Suhagpure
13	Tina. G. Rahangdale	9991776769	tinarahangdale@gmail.com	Tinarahangdale
14	Siddharth G. Hiskane	9579092931	hiskane.siddharth1234@gmail.com	Siddharth Hiskane
15	Vaishnavi R. Lakhe	8669594864	chhakuli.lakhe56@gmail.com	Vaishnavi Lakhe
16	Chhakuli G. Wadikar	9325047907	chhakuli.wadikar@gmail.com	Chhakuli Wadikar
17	Prajwal S. Bhoyar	8010434634	Prajwalb738@gmail.com	Prajwal Bhoyar
18	Jyoti J. Sharma	8669736380	jyoti's 5390@gmail.com	Jyoti Sharma
19	Nrupesh M. Sharma	9322042259	nrupeshsharma255@gmail.com	Nrupesh Sharma
20	AMAN ANIL DONGRE	7709217312	amandongre2000@gmail.com	Amang Dongre
21	Sania A. Roy	8975726700	midhaternia@gmail.com	Sania Roy
22	Nikita J. Kallo	9067324988	kaltonikita54@gmail.com	Nikita Kallo
23	Sakshi S. Meshram	9145855483	sakshimeshram210@gmail.com	Sakshi Meshram
24	Kajal P. Nigot	9373250629	kajalnigot2000@gmail.com	Kajal Nigot
25	Juhi S. Chaudhari	8669248944	chaudharyjuhi110@gmail.com	Juhi Chaudhari
26	Mansi K. Mall	9468891807	mansi19182@gmail.com	Mansi Mall
27	Urnita V. Bondre	9370673867	bondrevurnita2000@gmail.com	Urnita Bondre
28	Shravya Athawade	8888264004	shravyathawade124@gmail.com	Shravya Athawade
29	Vaibhavi Shende	9080840782	vaibhavishende87@gmail.com	Vaibhavi Shende
30	Gargi L. Wadga	7972076671	gargiwadga@gmail.com	Gargi Wadga
31	Kajal P. Wadga	8765421911	kajalw@gmail.com	Kajal Wadga

Signature of:
Programme In-charge
Tamisk

INTERNAL QUALITY ASSURANCE CELL
DHARAMPETH, M. P. DEO MEMORIAL &
SCIENCE COLLEGE, NAGPUR

Principal
[Signature]
PRINCIPAL
Dharampeth M.P. Deo Memorial
Science College, Nagpur-440033



DHARAMPETH M. P. DEO MEMORIAL SCIENCE COLLEGE, NAGPUR
INTERNAL QUALITY ASSURANCE CELL (IQAC)
NEP Activity Report

Date: 8/10/23

Name of Organizing Department or Committee: Department of Chemistry

Name of the activity: NEP Activity B.Sc. Sem V Unit 1

Suggested CRITERION point if any: Criteria II

Date of Activity: 04/10/22

Place of Activity: Chemistry lab. 3rd floor

Name of Guest Speaker/s or Judge/s or Chief Guest/s if any: Nil

Title of the Activity: Demonstration of different derivatives of different compounds and its applications.

Number of Participants: 47

Name of the Teacher In-charge / Convener: Dr. Sandip Madhukar Bhiwagade

Names of other Committee Members / Staff: Dr. Vaishali P. Meshram

OUTCOME of the Activity with respect to mission vision of the institute and or academics:

This is student centric activity. This activity helps to understand students how to synthesize derivative of given organic compound. In this activity student learn and synthesize benzene diazonium salt derivative of amine compound which is then converted into dye. In this activity student learns about the derivative preparation of organic compound and its uses.

Activity with newspaper coverage if any : Nil

Activity data save in PC of: Department of Chemistry



Prof. Pitambar Humane

IQAC Coordinator

CO ORDINATOR

INTERNAL QUALITY ASSURANCE CELL
DHARAMPETH, M. P. DEO MEMORIAL &
SCIENCE COLLEGE, NAGPUR

Dr. Sandip Bhiwagade
Bhiwagade

Name & Signature of Teacher In-charge

Principal

PRINCIPAL

Dharampeth M.P. Deo Memorial
Science College, Nagpur-440033



DHARAMPETH M. P. DEO MEMORIAL SCIENCE COLLEGE,
North Ambazari Road, Near Ambazari Lake, Nagpur- 440033

Date: 4/10/22

DATA VALIDATION & VERIFICATION (DVV)

Name of the Programme : NEP Activity (Preparation of AZO dye) / demonstration of different derivatives of different comp. & its application.

Date of the Programme : 4/10/22

Name of Chief Guest if any : _____

Name of Guest Speaker if any : _____

Sr. No.	Name of the Participant	Mobile Number	E-mail Id	Signature
1	Amit warde	9302900209	walde202002@gmail.com	
2	Ashish Nandedo warde	7972190515	ashishnandedo@gmail.com	
3	Damini Bhandbuche	9356413802	bhandbuche2002@gmail.com	D. Bhandbuche
4	HARSHAD KARTHIK	9021019101	harshadk2002@gmail.com	Harshad
5	Nikita Pund	9579643389	vandnikita5@gmail.com	
6	Prachi Warbhadre	7517090406	warbhadre2002@gmail.com	Prachi Warbhadre
7	Aarati Bisen	8605399606	BisenA87@gmail.com	Aarati Bisen
8	Aditi Tike	9850163812	adititike2002@gmail.com	
9	Shruti Pawar	8275105785	pawarshruti9877@gmail.com	
10	Suhani Indurkar	7378512502	indurkar2002@gmail.com	

Signature of:
Programme In-charge

IAC COORDINATOR
INTERNAL QUALITY ASSURANCE CELL
DHARAMPETH, M. P. DEO MEMORIAL &
SCIENCE COLLEGE, NAGPUR

Principal
PRINCIPAL
Dharampeth M.P. Deo Memorial
Science Coll. Nagpur-440033



DHARAMPETH M. P. DEO MEMORIAL SCIENCE COLLEGE,
North Ambazari Road, Near Ambazari Lake, Nagpur- 440033

DATA VALIDATION & VERIFICATION (DVV)

11.	Krushnali Sanjay Kadam	8625854995	krushnalikadam67@gmail.com	Kadam
12.	Bhumnika Devendra Chedde	8830891103	bhumnikachedde@gmail.com	Chedde
13.	Poojari Laxmikant Dandale	9325673318	dandalepoojari16@gmail.com	Dandale
14.	Astha Abhay Sakharwade	9405197842	asthasastha@gmail.com	Sakharwade
15.	Avanti Ashish Chaphekar	7825173847	avanti1011@gmail.com	Avanti
16.	Anjali Namdeo Chasde	8261964188	anjalicbasde20@gmail.com	Chasde
17.	Ayushi D. Shukla	9373668043	ayushishukla28112002@gmail.com	Shukla
18.	Krushika D. Aundhkar	8767279513	krushikaundhkar652@gmail.com	Krushika
19.	Raksha Dhote	7498511875	rakshadhote3@gmail.com	Dhote
20.	Pallavi Bhagat	9022654940	pallavi2208@gmail.com	Bhagat
21.	Priyanshi Singh	7219259020	priyanshisingh18040@gmail.com	Singh
22.	Chaitali M. Burebade	9359540394	chaitali20206@gmail.com	Chaitali
23.	Anushka D. Desai	7058933157	ad04092001@gmail.com	Desai
24.	Tanushree R. Dadi	9766927406	tanushreedadi@gmail.com	Dadi
25.	Sakshi Surendra Moon	7745827736	sakshim3030@gmail.com	Moon
26.	Muskan H. Sheikh	8055474633	Muskan2019sss@gmail.com	Sheikh

Signature of:

Programme In-charge

CO-ORDINATOR
IQAC COORDINATOR, QUALITY ASSURANCE CELL
DHARAMPETH, M. P. DEO MEMORIAL &
SCIENCE COLLEGE, NAGPUR

Principal
PRINCIPAL
Dharampeth M.P. Deo Memorial
Science College, Nagpur-440033

27.	SHIVANI BHUTE	9302900209	Bhuteshivani@gmail.com	<u>Shivani</u>
28.	VIKITA EKRE	7972190515	EksaVikita02@gmail.com	<u>Nikita</u>
29.	Sayli S. Lokhande	9356413804	Sayalilokhande@gmail.com	<u>Lokhande</u>
30.	Nikita D. Shebe	9021019101	nikita.shebe2019@gmail.com	<u>Shebe</u>
31.	Aachal S. Wagh	9574643389	aachalwagh2003@gmail.com	<u>Wagh</u>
32.	Saumiksha Choudhary	7517090406	choudharysaumiksha26@gmail.com	<u>Stry.</u>
33.	Vaishnavi Chandekar	7249882964	Vaishnavichandekar000@gmail.com	<u>Chandekar</u>
34.	Megha S. Fulwar	8605399606	Mfulwar@gmail.com	
35.	Meuruli R. Songare	9850163812	songaremeuruli16@gmail.com	<u>RSongare</u>
36.	Neha A. Waghade	7249895144	nehawaghade16082002@gmail.com	<u>Waghade</u>
37.	Damini M. Bardbuche	8275105785	bardbuchedamini@gmail.com	<u>D. Bardbuche</u>
38.	Rakhi Gedam	7378312505	gedamrakhi2000@gmail.com	<u>Rpledem</u>
39.	Prachi S. Waghale	8767914118	Prachiwaghale11@gmail.com	<u>Waghale</u>
40.	Pragya R. Jha	9665852975	pragya1687687@gmail.com	<u>Jha</u>
41.	Akanksha R. Yeluge	8767935524	akankshayeluge@gmail.com	<u>Akanksha</u>
42.	Vedika P. Karankar	9145149787	vedikakarankar@gmail.com	<u>VK</u>
43.	Roji N. Pathan	8669398198	Rojikhan66024@gmail.com	<u>R Pathan</u>
44.	Nikita R. Rahangdale	9307723308	nikitastahangdale2005@gmail.com	<u>Rahangdale</u>
45.	Divya T. Bondre	8668454925	divyabondre2@gmail.com	<u>Divya</u>
46.	Sufriya Patle	7757871925	Patlesufriya123@gmail.com	<u>Patle</u>
47.	Snehal A. Bute	7058756570	snehalbute7218@gmail.com	<u>Sbute</u>



DHARAMPETH M. P. DEO MEMORIAL SCIENCE COLLEGE, NAGPUR
INTERNAL QUALITY ASSURANCE CELL (IQAC)

Activity Report

Date: 07/10/2022

Name of Organizing Department or Committee: Microbiology Department

Name of the activity: Visit to Indira Gandhi Rugnalaya and Arpan Blood Bank

Suggested CRITERION point if any: Criterion II

Date of Activity: 7th October 2022 and 8th Oct 2022

Place of Activity: Indira Gandhi Rugnalaya and Arpan Blood Bank

Name of Guest Speaker/s or Judge/s or Chief Guest/s if any: Guest Speaker- Nil

Title of the Activity: Demonstration of Acid-Fast Staining and PCR Technique for diagnosis of TB

Number of Participants: 37 students of Sem V

Name of the Teacher In-charge / Convener: Dr. Vidya R. Kathoke

Names of other Committee Members / Staff: Dr. Pratiksha Pohekar and Diksha Zade

OUTCOME of the Activity with respect to mission vision of the institute and or academics:

1. It helps to create interest in the subject, also enhances practical knowledge about various communicable diseases like TB and its necessity of control in the society.
2. To enhance research aptitude and to address the queries of curious minds through communication with the medical officers.
3. They come to know about the importance of blood donation, and importance of various blood components, its separation methods and storage methods, through live demonstration.



Activity with newspaper coverage any:

Prof. Pitambar Humane
IQAC Coordinator

Dr. Vidya R. Kathoke
Name & Signature of Teacher In-charge

Dr. Akhilesh Peshwe
Principal

VISIT TO INDIRA GANDHI HOSPITAL FOR ACID FAST STAINING

PLACE:- INDIRA GANDHI HOSPITAL
DATE:-8TH OCTOBER 2022

Hospital visit was organized by Dr. Vidya kathoke Mam. The hospital visit started on time 10pm. We visited a hospital for acid fast staining and a blood bank room. First of all we saw the blood bank room. On the first floor we got the information about blood donation.

Hospitals offered their valuable services for blood donation. In blood Bank room Mam told that how the separate blood components like as plasma, WBCs, RBCs, platelets in Quality control room. we also got the information about blood donor and Recipient (patient). Blood donor Person should be age above 18+ and blood donor person should not be infected for the donation of blood. Before blood donation first of donor should be check B.P and diabetes and sugar test. Blood donor person (Girl) should have hemoglobin 15.

In the blood bank room we saw some machines such as Laminar flow in the refreshment room for patients. After visiting the blood bank room we visited a lab for Acid fast staining. We got information about Acid fast staining occurred in such type of microorganism which have waxy covering in bacterial cell. Due to this covering in bacterial cell Acid fast staining done.

This type of organism do not get decolorized By strong agent. In Acid fast staining some strong reagents into the bacterial cell First of all taken sputum of T.B. patient and made a smear on the slide. Reagents are used such as carbol fushion, H₂SO₄ acid, Methylene blue. In Acid fast staining

Mycobacterium colonies detected which is red coloured rod shape.

After that we visited the PCR Room where CBNAAT machines were available and in that machine cartridges contained sputum samples and were then placed in CBNAAT machines. CBNAAT machine connected with monitor

and shown the report about T.B. the patient. Machine required a high temperature in a cold room. Monitor displayed report of T.B. patient Negative then Rifampicin drug not given to the patient. If the report of

T.B. is positive i.e. person was infected with T.B. disease. this patient is diagnosed that the body resist Rifampicin or it was sensitized to it. If it resist Rifampicin then second line drugs was given for treatment. If it sensitized Rifampicin then 1st line drugs was given for treatment. Two types of patient T.B. patient. 1- pulmonary tract T.B. 2- Extra pulmonary tract TB for diagnosis, x-ray, gene -Expert PCR, True north and is Acid fast Staining is done. Two machines was used for diagnosis CABINET, True nert.

ADVANTAGES OF CABINET OVER TRUE NERT

- 1- There was no manual work carried out in CABINET. Whole process of testing is machine based.
- 2- It had good result accuracy as compared to True nert.

ADVANTAGE OF TRUE NERT OVER CABINET

- 1- CABINET required high temperature AC- Room and true nert was flexible in any temperature it can be shifted to any place for diagnosis and testing
- 2- CABINET was more expensive and true-nert was cheaped but less accuracy to result.

Reported by
Sadaf A. Sheikh
Suhani P. Indurkar
Manali S. Shinde
Nandini P. Pounikar

W. R. Kothhoke

P. U. R. Kothhoke
Head
DEPT. of Microbiology
M. S. S. Hospital
M. S. S. Hospital

[Signature]

DHARAMPETH EDUCATION SOCIETY'S
**DHARAMPETH M. P. DEO MEMORIAL
SCIENCE COLLEGE**

North Ambazari Road, Near Ambazari Lake, Nagpur-440033 (M.S.)
Ph. No. 0712-2241312/2241400 Fax: 2241125
Email: principal_dmpde@mail.com www.dharampethscience.com



Ref:

Date: 27/09/2022

To,
Medical Officer,
Indira Gandhi Rughalaya,
Nagpur

07/10/22 and 08/10/22

Subject: Visit to Indira Gandhi Hospital on dated 30/09/2022 and 01/10/2022.

Respected Sir,

As a part of curriculum for undergraduate students a visit to **Indira Gandhi hospital** is to be arranged at your institute for B.Sc. Part - III students on 30/09/2022 and 01/10/2022 at 12.30 pm. Total no. of students were 70 along with one teacher.

Therefore I request you to permit me for the same.

Thanking you

V. R. Kathoke
(Dr. Mrs. V. R. Kathoke)

Head
V. R. Kathoke
Head
Deptt. of Microbiology
Dharampeth MP Deo Memorial
Science College, Nagpur

Akhilesh Peshwe
Dr. Akhilesh Peshwe

Principal
Principal
Dharampeth M. P. Deo Memorial
Science College, Nagpur.

Slawh
28/9/22
Arpan Blood Center
Nagpur

MS MGR
28/9/22

TB Staff
available

so pls on wards 5 meet.
come after 7A.
at 10 am. Oct.



DHARAMPETH M. P. DEO MEMORIAL SCIENCE COLLEGE,
North Ambazari Road, Near Ambazari Lake, Nagpur- 440033

DATA VALIDATION & VERIFICATION (DVV)

Name of the Programme

: Visit to Hospital & Blood Bank

Date of the Programme

: 7th Oct 2022 & 8th Oct 2022

Name of Chief Guest if any

: _____

Name of Guest Speaker if any

: _____

Sr. No.	Name of the Participant	Mobile Number	E-mail Id	Signature
	Ayushi Shukla	9373668043	ayusheshukla28112002	
	Sagli S. Lokhande	9356413804	sagyalokhande2910@gmail.com	
	Samiksha N. Kundekar	9145253759	samikshakundekar@gmail.com	
	Rashmi M. Bambal	9325853408	Rashmi201816@gmail.com	
	Shiwani P.R. Dwivedi	8855900546	Shiwaniidwivedi@gmail.com	
	Krushnali S. Kade	8625854995	krushnalikade67@gmail.com	
	Bhumika D. Chedga	8830391103	bhumikachedga@gmail.com	

Signature of:

Programme In-charge

IQAC Coordinator

Principal
Principal, P. Deo Memorial
Science College, Nagpur



DHARAMPETH M. P. DEO MEMORIAL SCIENCE COLLEGE,
North Ambazari Road, Near Ambazari Lake, Nagpur- 440033

DATA VALIDATION & VERIFICATION (DVV)

	Amishi. S. Wele	8530778433	amshicwele@gmail.com	
	Madhura U. Bhandare	8767484914	madhuraubhandare@gmail.com	
	Anjali R. Pali	7498102109	palianjali46@gmail.com	
	Shreyansh S. Naikwar	7447844189	shreyanshnaikwar7@gmail.com	
	Rupesh W. Wadde	8329676611	Rupeshwadde780@gmail.com	
	Balraj M. Wadgaonkar	7420896682	Balrajwadgaonkar@gmail.com	
	Rishabh C. Wankhede	8010966523	wankhede.rishabh@gmail.com	

Signature of:

Programme In-charge

IQAC Coordinator

Principal



DHARAMPETH M. P. DEO MEMORIAL SCIENCE COLLEGE,
North Ambazari Road, Near Ambazari Lake, Nagpur- 440033

DATA VALIDATION & VERIFICATION (DVV)

1)	Laxmi Gaule	7758058514	laxmigaule2902@gmail.com	Laxmi Gaule
2)	Nandini Hodge	9370301679	nandinihodge17@gmail.com	Nandini
3)	Bhargavi Sambare	7709403806	bhargavisambare05@gmail.com	Bh.
4)	Shikha Thakre	8010907069	ishithakre22@gmail.com	Shikha
5)	Aishwarya Joshi	7498328662	aishwaryajoshi2005@gmail.com	Aishi
6)	Shruti Pawar	9521988107	shrutipawar0707@gmail.com	Shruti Pawar
7)	Tammy Chaudhary	8600102341	tammychaudhary3@gmail.com	Tammy
8)	Neha Chandratne	9156873192	nehachandratne346@gmail.com	Neha Chandratne
9)	Sadat Purven Sheikh	9673410401	sheikhsadat934@gmail.com	Sadat
10)	Suhani Indurkar	9370419064	suhaniindurkar990@gmail.com	Suhani
11)	Manali Shinde	7249637434	manalishinde002@gmail.com	Manali
12)	Ashti Baboolal Bisen	8767549078	ashtibisen129@gmail.com	Ashti
13)	Smriti M. Gaikwad	7385532705	smritigaikwad86935@gmail.com	Smriti Gaikwad
14)	Arkita R. Bhoyar	8788031173	arkitabhoyar06@gmail.com	Arkita
15)	Richa N. Baradwaj	7972613061	richanbaradwaj@gmail.com	Richa
16)	Manish S. Grade	9370329857	manishgrade79@gmail.com	Manish

Signature of:

Kathake
Programme In-charge

IQAC Coordinator

Principal
Dharampeth M. P. Deo Memorial
Science College, Nagpur



DHARAMPETH M. P. DEO MEMORIAL SCIENCE COLLEGE,
North Ambazari Road, Near Ambazari Lake, Nagpur- 440033

DATA VALIDATION & VERIFICATION (DVV)

17	Sanket .K. Lode	7972085380	sanketlode123@gmail.com	<u>Sanket</u>
18	Suraj Yadav	8767635158	Surajshyam Yadav82@gmail.com	<u>Suraj</u>

Signature of:

Programme In-charge

IQAC Coordinator

Principal
Dharampeth M. P. Deo Memorial
Science College
Nagpur



DHARAMPETH M. P. DEO MEMORIAL SCIENCE COLLEGE, NAGPUR
DEPARTMENT OF COMPUTER SCIENCE
ACADEMIC SESSION: 2022-23

NOTICE

25th September 2022

All the students are hereby informed that the Department of Computer Science, Dharampeth M.P.Deo Memorial Science College, Nagpur is going to organize Intercollegiate Poster Presentation Competition "Stroke -O-Create" on 7th October 2022. All the interested students can register themselves on or before 5th October 2022. The details of the completion are as given below

Registration Link :

<https://forms.gle/MyFUzzhG8YefRKZX9>

Registration Fees :- 50 Rs. Only.*

Date: 7th October 2022

Time: 11.00am to 3.00pm

Venue: - Vinayakrao Phatak Hall, Dharampeth science college.

Topics :

- 1) AI Applications in real life.
- 2) Evolution and improvement of wireless communication.
- 3) Modern Applications of Nanoscience and Nanotechnology.
- 4) Data Structures and its applications.
- 5) Role of technology in healthcare system.

Co-ordinator /Convener

Dr. Snehal Narale

Principal

Dr. Akhilesh V. Peshwe

For more queries Contact:-

- 1) Rishikesh Delhe :- +91 8788199260
- 2) Aditi Lute :- +91 78208 12303
- 3) Sanchita Patil :- +91 72180 79074
- 4) Pranay Dhore :- +91 88306 29245

Head , Department of Computer Science
Head,
Department of Computer Science
Dharampeth M. P. Deo Memorial
Science College, Nagpur



DIHARAMPETH M. P. DEO MEMORIAL SCIENCE COLLEGE, NAGPUR
INTERNAL QUALITY ASSURANCE CELL (IQAC)

Activity Report

Date: 30th October 2022

Name of Organizing Department or Committee: Computer Science Department

Name of the activity: Intercollegiate Poster Presentation Competition

Suggested CRITERION point if any: Criteria II,V

Date of Activity: 7th October 2022

Place of Activity: College Campus

Name of Chief Guest/s if any: Prof.Dr.Satish Sharma, Head Department of Electronics and Computer Science, RTMNU Campus

Name of Guest Speaker/s or Judge/s or Chief Guest/s if any: Dr.Shweta Barhate, Department of Electronics and Computer Science ,RTMNU Campus , and Dr.Mamta Baheti (Head, Department of Computer Science ,Hislop College,Nagpur)

Title of the Activity: Stroke-O-Create

Number of Participants: 48

Name of the Teacher In-charge / Convener: Dr.Mrs.Snehal Narale

Names of other Committee Members / Staff: Mrs. Shraddha Ozarkar

OUTCOME of the Activity with respect to mission vision of the institute and or academics:

- The basic objective of this inter collegiate poster presentation competition was to prepare the students about the recent technology use in the market and explore their ideas in the form of poster.
- To provide a platform where the students can share their views and thoughts on the various topics for the competition in the form of the poster
- To allow Student to express themselves, through their personal vision, on the topic of their poster.
- To inculcate the habit of Learning's through different aids.
- This Activity helped the students to showcase their talent and creativity through the poster prepared by them.
- Such Competitions offer an excellent opportunity and platform to the students of UG and PG to present their ideas and research to a broad technical audience.
- This will also help them how to work in group which help them to enhance the team work.
- Students will be able to learn and gain insight on their research, basic and core knowledge on the topic and to receive live feedback and encouragement from others

Activity with newspaper coverage if any: Yes, Times of India

Live Nagpur Link

<https://thelivenagpur.com/2022/10/10/intercollegiate-poster-competition-held-at-dharampeth-m-p-deo-memorial-science-college/>

Registration Form Response Link:

<https://forms.gle/MvFUzzbG8YeFRKZX9>

Feedback Form Link

<https://forms.gle/5pe59wts7La56kja9>

Activity data save in PC of: Dr. Mrs. Snehal Narale's Laptop



Prof. Pitambar Humane
IQAC Coordinator
IQAC Co-ordinator
Dharampeth M.P. Deo Memorial
Science College, Nagpur-440033

Dr. Mrs. Snehal Narale
Name & Signature of Teacher In-charge

Dr. Akhilesh Peshwe
Principal
Principal
Dharampeth M.P. Deo Memorial
Science College, Nagpur.



DHARAMPETH M. P. DEO MEMORIAL SCIENCE COLLEGE,
North Ambazari Road, Near Ambazari Lake, Nagpur- 440033

Poster received

DATA VALIDATION & VERIFICATION (DVV)

Name of the Programme : Stoke-D-Create (Inter colligate Poster Competition)
 Date of the Programme : 07-10-22
 Name of Chief Guest if any : Dr Prof. Satish Sharma, Head dept of Electronics & comp sci, RTMNU
 Name of Guest Speaker if any : _____

Sr. No.	Name of the Participant	Mobile Number	E-mail Id	Signature
1	Chaitanya P. Sahu VMV College.	7719971239	Chaitanyasahu1110@gmail.com	
2	Ayushi B. Wankhede Kamla Nehru Mahavidyalaya college	8999883459	ayushibwankhede@gmail.com	
3.	Sushli - M. fulekar Shri Mathuradas mahata college of science	9975926543	Sushlifulekar2@gmail.com	
4.	Mansi. M. Bahare St. Francis De sales college.	7666401023	sahumansik@gmail.com	

Signature of:

Programme In-Charge
 Department of Computer Science
 Dharampeth M. P. Deo Memorial
 Science College, Nagpur

CO-ORDINATOR
 INTERNAL QUALITY ASSURANCE CELL
 DHARAMPETH, M. P. DEO MEMORIAL &
 SCIENCE COLLEGE, NAGPUR

Principal
 Dharampeth M. P. Deo Memorial
 Science College, Nagpur



DHARAMPETH M. P. DEO MEMORIAL SCIENCE COLLEGE,
North Ambazari Road, Near Ambazari Lake, Nagpur-440033

DATA VALIDATION & VERIFICATION (DVV)

5	Shenil Ahmed St. Francis De Sales College	9343499373	shenilahrped1206@gmail.com	Shenil
6	Somesh B. Tupte RTMNU, Campus	8982701073	someshupte@gmail.com	Supte
7	Gaurav S. Sharma RTMNU, Campus	9321897141	gs7616004@gmail.com	Grae
8	Pooja J. Manje RTMNU, Campus	9921824883	manjepooja05@gmail.com	Manje
9	Sandesh R. Damube RTMNU, Campus	8767005107	sandeshdamube96@gmail.com	Damube
10	Khushi Pali DSC	8767607224	khushi4@gmail.com	Khushi
11	Srinandhimak DSC	7666330683	sirinandhimak9@gmail.com	Srinandhimak
12	Aarti Singh DSC Sakshi Huddar DSC	7709202740 9405112450	aartisingh222@gmail.com sakshihuddar@gmail.com	Aarti Singh Sakshidast
13	Khushi Dinesh Waghade	9156520785	khushidineshwaghade@gmail.com	Khushi D. Waghade
14	Priyanka Rajesh Ghumade	7744031278	priyankaghumade@gmail.com	Ghumade

Signature of:

Program In-charge
Department of Computer Science
Dharampeth M. P. Deo Memorial
Science College, Nagpur

COORDINATOR
INTERNAL QUALITY ASSURANCE CELL
DHARAMPETH M. P. DEO MEMORIAL &
SCIENCE COLLEGE, NAGPUR

Principal
Dharampeth M.P. Deo Memorial
Science College, Nagpur.



DHARAMPETH M. P. DEO MEMORIAL SCIENCE COLLEGE,
North Ambazari Road, Near Ambazari Lake, Nagpur - 440033

DATA VALIDATION & VERIFICATION (DVV)

15	Suman . R. Singh	9322018536	sumanrsingh123456789@gmail.com	Suman
16	Tanmay . S. Gadgil	7762034396	tanmaygadgil@gmail.com	Tanmay
17	Jasany . P. Patke	94211289044	Jasany.p@nptel.com	Jasany
18	Chetana . R. Sawalkar	7499489649	chetana.sawalkar@nptel.com	Chetana
19	Vishal . Y. Rishikesh	9673691472	vishal.y.rishikesh@gmail.com	Vishal
20	Arushi . K. Ashwini	8329981958	Arushisambare@gmail.com	Arushi
21	vicky A. Singh	9834782931	vicky.singh11032000@gmail.com	Vicky
22	Vaiharavi Jadhav	9156916355		Vaiharavi
23	Sankalp Bisan	7442662009	sankalpbisan@gmail.com	Sankalp
24	Seema Lalada	7058728070	Seemalakda073@gmail.com	Seema
25	Isha Nemade	7028494761	ishanemada33@gmail.com	Ishane
26	Ved . S. Choudhary	7498672766	vedkoudhary.cs.24@gmail.com	Ved
27	Ragini E. Farkade	9049345670	ragini.farkade36@gmail.com	Ragini
28	Priyanka Birish Jashi	8530404718	peeha31217@gmail.com	Priyanka
29	Sarthak Sanjay Chatur	7588741574	Sarthakchatur2002@gmail.com	Sarthak
30	Anuj B Kamble	7972614457	Anujkamble07@gmail.com	Anuj

Signature of: Department of Computer Science & Electronics, P.T.M. Nagpur University.

(Signature)

(Signature)

Programme Incharge
Department of Computer Science
Dharampeth M. P. Deo Memorial
Science College, Nagpur

CCQA Coordinator
INTERNAL QUALITY ASSURANCE CELL
DHARAMPETH M. P. DEO MEMORIAL
SCIENCE COLLEGE, NAGPUR

Principal
Dharampeth M. P. Deo Memorial
Science College, Nagpur



DHARAMPETH M. P. DEO MEMORIAL SCIENCE COLLEGE,
North Ambazari Road, Near Ambazari Lake, Nagpur- 440033

DATA VALIDATION & VERIFICATION (DVV)

31.	Khushi Gupta	9022997235	kg098920@gmail.com	<u>Khushi</u>
32	Pratham Sonare (Dharampeth Sci. Clg)	5295651974	Sonam.p5at@gmail.com	<u>Pratham</u>
33	Haritik Mishra	9067445755	Kamari Anishtha Mishra 1018@gmail.com	<u>Haritik</u>
34	Saundhan Khande, Harsha Mankan VMV Collage	8411070120	harshamankan53@gmail.com	<u>Harsha</u>
35	Pallavi B. Katre [2 nd year]	8459 277408	Pkatre573@gmail.com	<u>Pallavi</u>
36	Sujata Kaware [2 nd year] Dharampeth College.	9175051202	Sujatakaware5@gmail.com	<u>Sujata</u>
37	Hitesh Kaware & Ankur Kuspari (Dharampeth science college '2nd year')	7058427112	hiteshkaware73@gmail.com	<u>Hitesh</u>
38	Ankumar D. Devangan, Dharampeth M.P. Deo Memorial Science College Harsha Mankan	9763624388	Ammani13@gmail.com	<u>Ankumar</u>

Signature of:

Ranale

Programme Incharge

Department of Computer Science
Dharampeth M. P. Deo Memorial
Science College, Nagpur

[Signature]

COORDINATOR
IQAC Coordinator

DEPARTMENT OF COMPUTER SCIENCE
DHARAMPETH M. P. DEO MEMORIAL
SCIENCE COLLEGE, NAGPUR

[Signature]

Principal
Dharampeth M. P. Deo Memorial
Science College, Nagpur



DHARAMPETH M. P. DEO MEMORIAL SCIENCE COLLEGE,
North Ambazari Road, Near Ambazari Lake, Nagpur-440033

DATA VALIDATION & VERIFICATION (DVV)

39	Mohit Khadkekar and Jagan Singh 1 st year Dharampeth college	9055328357	mohitkhadkekar@gmail.com	Mohadkekar
40	Chetan Shankar Sonawkar Poo.S.K. Wankhede college of education. Priti Sunesh Kerkhade - JG-MB, Mayo, Nagpur	9579939051	chetan_sonawkar09@gmail.com	
41	Priti. Devraj. Motghare. VMV college. Karti. Barapatre.	9356406440	pritimotghare4032@gmail.com	Priti
42.	Khushboo Ganesh Walmik	8983700782	khushboowalmik14@	Khushboowalmik
43.	Mahi madne	9465688291	mahimadne@gmail.com	Mahimadne
44.	Mayuri Chinchulkar.	9156921320		Mayuri

Signature of:

Program In-charge

COORDINATOR
INTERNAL QUALITY ASSURANCE CELL
DHARAMPETH M. P. DEO MEMORIAL &
SCIENCE COLLEGE, NAGPUR

Principal
Dharampeth M. P. Deo Memorial
Science College, Nagpur.



DHARAMPETH M. P. DEO MEMORIAL SCIENCE COLLEGE, NAGPUR
INTERNAL QUALITY ASSURANCE CELL (IQAC)

Activity Report

Date: 30/10/22

Name of Organizing Department or Committee: Zoology

Name of the activity: Guest lecture and workshop on Insect photography

Suggested CRITERION point if any: Criteria II

Date of Activity: 7/10/2022

Place of Activity: Abdul Kalam Hall

Name of Guest Speaker judge/s or Chief Guest/s if any: Mr Alok Sheode

Title of the Activity: Guest lecture and workshop on Insect photography.

Number of Participants: 100

Name of the Teacher In-charge / Convener: Dr. K. M. Paturkar

Names of other Committee Members / Staff: Dr. K. M. Paturkar

OUTCOME of the Activity with respect to mission vision of the institute and or academics:

Students explore various way of photography with proper explanation on do's and dont's

Student enjoyed videos and presentation showing emotions of various insects

Students can now explore their surrounding and develop photography skills

Activity with newspaper coverage if any: NIL

Activity data save in PC of: Zoology Department/personal laptop



Prof. Pitambar Humane
IQAC Coordinator

Dr. Kirti Paturkar

Name & Signature of Teacher In-charge

Dr. Anil Peshwe
Principal

CO ORDINATOR
 INTERNAL QUALITY ASSURANCE CELL
 DHARAMPETH, M. P. DEO MEMORIAL
 SCIENCE COLLEGE, NAGPUR

Principal
 Dharampeth M. P. Deo Memorial
 Science College, Nagpur



DHARAMPETH M. P. DEO MEMORIAL SCIENCE COLLEGE,
North Ambazari Road, Near Ambazari Lake, Nagpur- 440033

DATA VALIDATION & VERIFICATION (DVV)

Name of the Programme : Guest lecture and Workshop on "Inset Photography"
Date of the Programme : 7/10/2022
Name of Chief Guest if any : Mr. Alok Shinde
Name of Guest Speaker if any : Mr. Alok Shinde

Sr. No.	Name of the Participant	Mobile Number	E-mail Id	Signature
1.	sakshi sunil Gisi	9529660277	sakshigisi2004@gmail.com	
2.	Muskan R. Yadav	9579492617	muskan.yadav1225@gmail.com	
3.	Akansha sanjay Bhute	9356964121	akansha2020@gmail.com	
4.	Asmita Dhannaj Chavhan	7387005732	asmitachavhan25@gmail.com	
5.	Nikhil R. Raut	9022680159	nautn654@gmail.com	
6.	Nikita S. Bapatkar	7058625053	peachikarapate05@gmail.com	
7.	Devashish D. Bisen	7767861231	Devashishbisen3@gmail.com	
8.	Devashri Devashri Bisen	8698119078	Dibisen74@gmail.com	
9.	Chirayu Bhagwant Dolat	8010135012	chirayudolat22@gmail.com	CB Dolat
10.	Sagar Shrikant Bawane	9975460979	sagarbawane7@gmail.com	
11.	Kalyani C. Ghahare	9307046378	ghaharekalyani5@gmail.com	
12.	Manali S. Shinde	7249637434	manalishinde062@gmail.com	
13.	Haresh S. Kodape	9604677672	hareshkodape008@gmail.com	
14.	Vedant V Baxy	8530155796	vedantbaxy2003@gmail.com	

Signature of:
Programme in-charge

IQAC Coordinator
IQAC Co-ordinator

Dharampeth M.P. Deo Memorial
Science College, Nagpur-440033

Principal
Principal

Dharampeth M.P. Deo Memorial
Science College, Nagpur.



DHARAMPETH M. P. DEO MEMORIAL SCIENCE COLLEGE,
North Ambazari Road, Near Ambazari Lake, Nagpur- 440033

DATA VALIDATION & VERIFICATION (DVV)

Sr. No.	Name of the Participant	Mobile Number	E-mail Id	Signature
01	Arush A. Kadam	9763013263	ak2855036@gmail	
2)	Sumit S. Bandebuche	8788212339	sumitbandebuchelan@gmail.com	
3)	Sanket K. Lode	7772085380	sanketlode123@gmail.com	
4)	Suraj Yadav	8767435158	suraj84yadav123@gmail.com	
5)	Prajwal Mungde	9834234902	prajwalmungde123@gmail.com	
6)	Shubham Bisen	744828 95 44	shubham01bisen@gmail.com	
7)	Kalpna Suhagpure	9579236412	kalpanasuhagpure@gmail.com	
8)	Vishakha Baswant	8329639834	vishakhabaswante@gmail.com	
9)	Vaibhav A. Malewar	8767838219	vaibhavmalewar1994@gmail.com	
10)	Giddheram Hiskane	9579092931	hiskane8ididhuden1234@gmail.com	
11)	Rupesh Bhakre	8805887370	bhakraerupesh@gmail.com	
12)	Tejas Rewade	7796027056	rewadetejas@gmail.com	
13)	Shreyas Dhanule	8888264004	shreyasdhanule@gmail.com	
14)	Vaibhavi Shende	8080640782	vaibhavishende.2001@gmail.com	
15)	Urmila Bondre	9370673867	bondreurmila.2000@gmail.com	
16)	Bhargavi Sambare	7709403806	bhargavisambare05@gmail.com	
17)	Laxmi Gaule	7758058514	laxmigaule2508@gmail.com	

Signature of:
Programme in-charge

IQAC Co-ordinator
Dharampeth M.P. Deo Memorial
Science College, Nagpur-440033

Principal
Dharampeth M.P. Deo Memorial
Science College, Nagpur.



DHARAMPETH M. P. DEO MEMORIAL SCIENCE COLLEGE,
North Ambazari Road, Near Ambazari Lake, Nagpur- 440033
DATA VALIDATION & VERIFICATION (DVV)

Sr. No.	Name of the Participant	Mobile Number	E-mail Id	Signature
1	Dhanshree Y. Newalkar	9356516280	newalkardhanshree@gmail.com	
2	Vaishnavi R. Lakhe	8669594864	chhakuli.lakhe536@gmail.com	
3	Mansi D. Raut	7385114931	Mansiraut451@gmail.com	
4	Chhakuli. G. Wadikar	9325047907	chhkuwadikar19@gmail.com	
5	Tina. G. Rahangdale	9921776769	tinarahangdale@gmail.com	
6	Twinkal G. Lokhande	8149176609	twenkallokhande14@gmail.com	
7	Pooja. S. Itankar	9156973252	poojaitankar987@gmail.com	
8	Vaishnavi R. Nandhure	9322439316	Vaishnavinandhure8@gmail.com	
9	Niket Thakre	7378899087	niketthakre@gmail.com	
10	Abhishek. D. Deshbhretar	8208302902	abhishekdeshbhretar56@gmail.com	
11	Nikita shyam Bayapathe	7058625053	ruachibayapathe05@gmail.com	
12	Mrunali Raghunath Somsare	9850163812	Somsaremrunali16@gmail.com	
13	Neha Arvind. Waghade	7249895144	nshawaghade16082002@gmail.com	
14	Aapita. Tejaso. Dakhale	8010866758	aspitadakhale02@gmail.com	
15	Rakhi Prabhakar Gjedum	7378312504	gedumrakhis000@gmail.com	
16	Anjali Anil Mishra	9325604513	anjalmishra4954@gmail.com	
17	Shrawanani Rajkumar Warkhede	8806636133	shrawananiwarkhede11@gmail.com	

Signature of:
Programme In-charge

IQAC Coordinator

Dharampeth M.P. Deo Memorial
Science College, Nagpur-440033

Principal

Dharampeth M.P. Deo Memorial
Science College, Nagpur.



DHARAMPETH M. P. DEO MEMORIAL SCIENCE COLLEGE,
North Ambazari Road, Near Ambazari Lake, Nagpur- 440033

DATA VALIDATION & VERIFICATION (DVV)

Sr. No.	Name of the Participant	Mobile Number	E-mail Id	Signature
1)	Rohan Meshram	7499956761	rohanmeshram49@gmail.com	
2)	Somyak Hadke	7020191304	somyakhadke30@gmail.com	
3)	Jeet Pardhi	7020215431	jeetspardhi111@gmail.com	
4)	Manthan Tadage	8080870420	manthantadage@gmail.com	
5)	Sajal Kothé	8483045985	kothesajal04@gmail.com	
6)	Akanksha Mairal	8010923662	akankshamairal2004@gmail.com	
7)	Khushi K. Rewade	9588445994	khushikrewade@gmail.com	
8)	Chanchal K. Waghwaní	7796016894	waghwanichanchal@gmail.com	
9)	Dhanashri Neware	9359909913	dhanashrineware@gmail.com	
10)	Gunjan Bhojare	8668335876	gunjanbhojare34@gmail.com	
11)	Yashashree Pramod Charde	9764008924	yashashreecharde@gmail.com	
12)	Pranali - Y. Chavhake	9699654562	pranalicavhake69@gmail.com	
13)	Nandini Hodge	9370301679	nandinihodge17@gmail.com	
14)	Ishika Thome	8010907069	ishithakore22@gmail.com	
15)	Poojaal bhajare	8010434634	poojaalbhajare@gmail.com	
16)	Shruti Pawar	8208725942	shrutipawar4@gmail.com	
17)	Aishwaryee Joshi		aishwaryeejoshi1@gmail.com	

Signature of:
Programme In-charge

IQAC Co-ordinator
Dharampeth M.P. Deo Memorial

Principal
Dharampeth M.P. Deo Memorial
Science College, Nagpur.



DHARAMPETH M. P. DEO MEMORIAL SCIENCE COLLEGE,
North Ambazari Road, Near Ambazari Lake, Nagpur- 440033

DATA VALIDATION & VERIFICATION (DVV)

Sr. No.	Name of the Participant	Mobile Number	E-mail Id	Signature
18	Anushree Chandel	9145631751	anuchandel2001@gmail.com	
19	Ketaki Karpal	9112759066	ketakikarpal13@gmail.com	
20	Smruti Vaidya	8856908764	SmrutiV36@gmail.com	
21	Khushabu Chaudhary	7262074960	khushabu.chaudhary98@...	
22	Akhina Sheikh	8080083981	abinasheikh973@gmail.com	
23	Gauri Raut	9767873447	ankuraaut2003@gmail.com	
24	Ashalesha Khadgi	8830414264	RupaliKhadgi25@gmail.com	
25	Sunaina Chichonde	8530970132	Sunainachichonde@gmail.com	
26	Shital Bankar	7758055139	shitalbankar122@gmail.com	
27	Nikita S. Bhawe	8860159628	NikitaBhawe98@gmail.com	
2	Vaishnavi T. Kapse	8983751089	vaishnavikapse05@gmail.com	
	Pratiksha Naughere	8623033760	naughere.pratiksha@gmail.com	
	Mansi. I. Mate	8468891807	Mansi19182@gmail.com	
	Juhi S. Chaudhari	8669248944	chaudharijuhi120@gmail.com	
	Sakshi Meshram	9145355733	sakshimeshram210@gmail.com	
	Jagruati Warkar	7447366023	jagruatiwarkar09@gmail.com	
	Tisha Kature	8208725992	tishakature@gmail.com	
	Tanmay Chaudhary	860010234	tchudhary8600@gmail.com	

Signature of:
Programme In-charge

IQAC Coordinator
IQAC Co-ordinator
Dharampeth M.P. Deo Memorial
Science College, Nagpur

Principal
Dharampeth M.P. Deo Memorial
Science College, Nagpur



INTERNAL QUALITY ASSURANCE CELL (IQAC)

Activity Report

Date: 07/10/2022

Name of Organizing Department or Committee: Department of Physics

Name of the activity: NEP based Demonstration Activity for B.Sc. Sem-V

Suggested CRITERION point if any: Restricted to RTMNU BSc physics syllabus.

Date of Activity: 07/10/2022

Place of Activity: Room no. 004

Name of Guest Speaker/s or Judge/s or Chief Guest/s if any: NA

Title of the Activity: Demonstration Comparison among MB, BE and FD statistics

Activity with newspaper coverage if any: No

Number of Participants: BSc Sem-V Students - 21

Name of the Teacher In-charge / Convener: Mr. Nishant Zode

Names of other Committee Members / Staff: N.A.

OUTCOME of the Activity with respect to academics:

This demonstration provided a unique opportunity to BSc Sem-V students to learn the comparison among MB, BE and FD statistics. These three statistics concern when how particles occupy a system which consists of several energy levels (and each energy level could also have several energy states). A particle in this system can be in one of those energy levels depending on the energy particle has. It's impossible to have just one particle in a system since in real life it needs various particles to constitute a system. They occupy the levels under a statistics rule

DVV: Enclosed.

Activity data save in PC of: Lt. Dr. P. W. Ambekar

Prof. Pitambar Humane
IQAC Coordinator

CO ORDINATOR
INTERNAL QUALITY ASSURANCE CELL
DHARAMPETH, M. P. DEO MEMORIAL &
SCIENCE COLLEGE, NAGPUR

HEAD
PHYSICS
Dharampeth M. P. Deo Memorial
Science College, Nagpur

Dr. Akhilesh Peshwe
Principal
Principal
Dharampeth M.P. Deo Memorial
Science College, Nagpur.

**DHARAMPETH M. P. DEO MEMORIAL SCIENCE COLLEGE NAGPUR****Department of Physics**

Class: B.Sc. Sem.-V

NEP ACTIVITY

Paper- I

Unit- IV

Name of the Teacher: Nishant ZodeDate: 07/10/2022Title of Activity: Comparison of MB, BE, and FD statistics

Sr. No.	Name of Student	Batch	Mobile No.	Email ID	Signature
1	Nikita R. Rahangdale	T9	9307723308	nikitarahangdale2009@gmail.com	<u>Nikita</u>
2	Nikita G. Gore	T10	7972190515	ernikita34@gmail.com	<u>Nikita</u>
3	Nikita D. Shebe	T8	9021019101	nikita.shebe2019@gmail.com	<u>Nikita</u>
4	Divya B. Bondre	T9	9850176023	divya.bondre03@gmail.com	<u>Divya</u>
5	Aarhal Wagh	T8	9579643381	aarhal.wagh2003@gmail.com	<u>Aarhal</u>
6	Sakshi Moon	T10	7745827736		<u>Sakshi</u>
7	Muskan Sheikh	T9	8055474633	muskan2019555@gmail.com	<u>Muskan</u>
8	Shivani Bhute	T-10	9302500209	shivani83@gmail.com	<u>Shivani</u>
9	Pratiksha S. Umare	T-3	9359175606	pratikshasumare50@gmail.com	<u>Pratiksha</u>
10	Pragya R. Jha	T-8	9605852975	pragya0@gmail.com	<u>Pragya</u>
11	Chaitali M. Ambade	T-8	8359540394	chaitali200@gmail.com	<u>Chaitali</u>
12	Priyanshi Singh	T-8	7219259020	priyanshisingh2001@gmail.com	<u>Priyanshi</u>
13	Raksha D. Hote	T-8	744288431	raksha123@gmail.com	<u>Raksha</u>
14	Soni A. Rai	T-5	8855919502	soniamailid@gmail.com	<u>Soni</u>
15	Seema Lakda	T-5	7058728070	seemalakda073@gmail.com	<u>Seema</u>
16	Pratiksha Chandhoni	T-5	7807317699	pratikshachandhoni@gmail.com	<u>Pratiksha</u>
17	Samiksha R. Khavare	T-5	9604473539	retrakhavare@gmail.com	<u>Samiksha</u>
18	Anjali N. Chavde	T-7	8261964188	anjalicavde20@gmail.com	<u>Anjali</u>
19	Tarunika R. Patil	T-9	9966927006	tarunikapatil@gmail.com	<u>Tarunika</u>
20	Rani N. Patil	T-9	8669575129	Ranipatil575@gmail.com	<u>Rani</u>
21	Rani D. Patil	T-9	8669595738	ranidpatil60@gmail.com	<u>Rani</u>

NZode

Signature of Teacher

W.S.

HEAD

HEAD OF DEPARTMENT
Dharampeth M. P. Deo Memorial
Science College, Nagpur



DHARAMPETH M. P. DEO MEMORIAL SCIENCE COLLEGE, NAGPUR

INTERNAL QUALITY ASSURANCE CELL (IQAC)

Activity Report

Date: 8th October 2022

Name of Organizing Department or Committee: Electronics Department

Name of the Activity : Analyzing the signals using CRO

Suggested CRITERION point if any: Suggested criteria II

Date of Activity: 8th October 2022

Place of Activity : Electronics Lab

Name of Guest Speaker/s or Judge/s or Chief Guest/s if any : Not applicable

Title of the Activity: Analyzing the signals using CRO

Based on Unit : 3(Paper 1)

Class : Semester I

Number of Participants: 16

Name of the Teacher In-charge / Convener: Mrs. Leena P. Thakare

OUTCOME of the Activity with respect to mission vision of the institute and or academics:

Students know how to see the signals on CRO. Students know how to measure the frequency and time of the signals on CRO

Prof. Varsha V. Rangari

Head of the Department



Prof. Pitambar Humane

IQAC Coordinator

CO ORDINATOR

**INTERNAL QUALITY ASSURANCE CELL
DHARAMPETH, M. P. DEO MEMORIAL &
SCIENCE COLLEGE, NAGPUR**



Dr. Akhilesh Peshwe

Principal

**Dharampeth M.P. Deo Memorial
Science College, Nagpur.**



DHARAMPETH M. P. DEO MEMORIAL SCIENCE COLLEGE, NAGPUR
Department of Electronics
Semester I- (2022-23)
Activity (Paper I- Unit- 3)

Sr. No.	StudentName	MobileNumber	Emailid
1	Sandeep Rakesh Kumar Kumar	8081144948	sandeepk27900@gmail.com
2	Ved Sudhir Choudhary	7498572766	vedchoudhary.cs.749@gmail.com
3	Vedant Onkar Umretkar	9049932753	umretkarvedant@gmail.com
4	Tushal Rupkumar Achare	9075995617	acharetushal5@gmail.com
5	Abhishek Ravindra Singh	8208948107	abhi0882005@gmail.com
6	Khushbu Rajiv Pali	8459565214	palikhushbu59@gmail.com
7	Khushi Rajiv Pali	8767607224	palikhushi4@gmail.com
8	Harshata Gunderao Warkhede	9860432428	bandukeshao20@gmail.com
9	Vaidhavi Baburao Gongal	7507907278	gayatrigongal787@gmail.com
10	Simran Narendra Dhimole	8390347026	mishralaxmi210@gmail.com
11	Tanu Ajay Singh	8806355808	tanusingh63492@gmail.com
12	Tejas Rajesh Chelmeelwar	9604662119	tejaschelmeelwar@gmail.com
13	Aayushi Vikram Singh	9595119942	senxerox04@gmail.com
14	Isha Ishwar Waghmare	8855919474	ishawaghmare9474@gmail.com
15	Bhagyashali Dadarao Neware	7796434177	sakshineware2017@gmail.com
16	Uday Chandrashekhar Baghele	8459549609	bagheleuday@gmail.com

Name & Signature of Teacher In-Charge

Prof. Pitambar Humane
IQAC Coordinator

CO ORDINATOR
INTERNAL QUALITY ASSURANCE CELL
DHARAMPETH, M. P. DEO MEMORIAL &
SCIENCE COLLEGE, NAGPUR

Name & Signature of Head of the Department

Dr. Varsha V. Ranbari
Professor & Head
Department of Electr. Dr. Akhilesh Peshwe
Dharampeth M.P. Deo Memorial Science College, Nagpur Principal

Principal
Dharampeth M.P. Deo Memorial
Science College, Nagpur.



DHARAMPETH M. P. DEO MEMORIAL SCIENCE COLLEGE, NAGPUR

**INTERNAL QUALITY ASSURANCE CELL (IQAC)
Activity Report**

Date: 08/10/2022

Name of Organizing Department or Committee: Department of Physics
Name of the activity: NEP based Demonstration Activity for B.Sc. Sem-I
Suggested CRITERION point if any: Restricted to RTMNU BSc physics syllabus.
Date of Activity: 08/10/2022
Place of Activity: Room No. 004
Name of Guest Speaker/s or Judge/s or Chief Guest/s if any: NA
Title of the Activity: Designing and construction of atomizer spray
Activity with newspaper coverage if any: No
Number of Participants: BSc Sem-I Students - 10
Name of the Teacher In-charge / Convener: Mr. Nikhil Somkule
Names of other Committee Members / Staff: N.A.

OUTCOME of the Activity with respect to academics:

This demonstration provided a unique opportunity to BSc Sem-I students to learn the application of Bernoulli's principle. In this activity a perfume bottle was dismantled and various parts of atomizer were viewed. In the atomizer a capillary tube is dipped in a liquid and air is blown at high speed over the tip of the tube. This high-speed air creates a low pressure over the vertical tube, due to which the liquid rises in it and is then blown off in very small droplets with expelled air.

DVV: Enclosed.

Activity data save in PC of: Lt. Dr. P. W. Ambekar

Prof. Pitambar Humane
IQAC Coordinator

COORDINATOR
INTERNAL QUALITY ASSURANCE CELL
DHARAMPETH, M. P. DEO MEMORIAL &
SCIENCE COLLEGE, NAGPUR

Name & Signature of Teacher in-charge

HEAD
Dharampeth M. P. Deo Memorial
Science College, Nagpur

Dr. Akhilesh Peshwe
Principal

Principal
Dharampeth M.P. Deo Memorial
Science College, Nagpur.



**DHARAMPETH M. P. DEO MEMORIAL SCIENCE COLLEGE, NAGPUR
ROTARACT CLUB OF DMPDSVM**

Activity Report

Date: 30 /10/2022

Name of Organizing Department or Committee: ROTARACT CLUB OF DMPDSVM

Name of the activity: Mental Health Day

Suggested CRITERION point if any: Criterion III & Criterion V

Date of Activity: 10th October 2022

Place of Activity: College

Name of Guest Speaker/s or Judge/s or Chief Guest/s if any: NIL

Title of the Activity: Mental Health Day

Number of Participants: 24

Name of the Teacher In-charge / Convener: Dr.Mrs.Shraddha Deshpande

Names of other Committee Members / Staff: Rotaract Club Members

OUTCOME of the Activity with respect to mission vision of the institute and or academics:

The overall objective of World Mental Health Day is to raise awareness of mental health issues among people and to mobilize efforts in support of mental health. Rotaractors spoke on these issues in which they emphasized the role of recreational activities in one's life to maintain mental health.

Activity with newspaper coverage if any: NIL

Activity data save in PC of: Department of English



Prof. Pitambar Humane
IQAC Coordinator

CO ORDINATOR
INTERNAL QUALITY ASSURANCE CELL
DHARAMPETH, M. P. DEO MEMORIAL &
SCIENCE COLLEGE, NAGPUR

Dr. Mrs. Shraddha Deshpande
Teacher In-charge

Dr. Akhilesh Peshwe
Principal

Dharampeth M.P. Deo Memorial
Science College, Nagpur.



DHARAMPETH M.P.DEO MEMORIAL SCIENCE COLLEGE, NAGPUR

ROTARACT CLUB 22-23

Mental Health Day

10th October 2022

Rotary.org Link





DHARAMPETH M. P. DEO MEMORIAL SCIENCE COLLEGE,
North Ambazari Road, Near Ambazari Lake, Nagpur- 440033

DATA VALIDATION & VERIFICATION (DVV)

Name of the Programme : World Mental Health Day (Fun Activities)
Date of the Programme : 10th October 2022
Name of Chief Guest if any : -
Name of ^{Co-ordinators} Guest-Speaker if any : Ananya Motghane (Secretary) Preraj Hodge (Vice President) Nupur Sharma (Joint Secretary)

Sr. No.	Name of the Participant	Mobile Number	E-mail Id	Signature
1.	Asmin .K. Sheikh	8668323568	asmino29@gmail.com	Asmin
2.	Manvi S. Fating	8767139686	manvijating2110@gmail.com	Manvi
3.	Shital R. Kelzarkar	9373329723	shital2020kk@gmail.com	Shital
4.	Kajal P. Nighat	9373250629	Kajalnighat2000@gmail.com	Kajal
5.	Divya .K. Hanote	8605422901	divyahanok0406@gmail.com	Divya
6.	Vineet om Singh	7558426949	SinghVineet75148@gmail.com	Vineet
7.	Simran N. Dhimale	7666330683	simrandhimale20@gmail.com	Simran
8.	Umang Wauthi	9322428500	Umangwauthi@gmail.com	Umang
9.	Ritika .A. Sondhiya	9175581655	ritikasondhiya@gmail.com	Ritika
10.	Mahi .S. Thaware	9960629566	thawaremahif@gmail.com	Mahi

Signature of:

Programme In-charge

CO-ordinator
INTERNAL QUALITY ASSURANCE CELL
DHARAMPETH, M. P. DEO MEMORIAL &
SCIENCE COLLEGE, NAGPUR

Principal
Dharampeth M.P. Deo Memorial
Science College, Nagpur.



DHARAMPETH M. P. DEO MEMORIAL SCIENCE COLLEGE,
North Ambazari Road, Near Ambazari Lake, Nagpur- 440033

DATA VALIDATION & VERIFICATION (DVV)

11.	Siddhi .B. Tiwari	8087143696	siddhitiwari0721@gmail.com	
12.	Muskan V. Kulkarni	9156889239	muskanukulkarni@gmail.com	
13.	Kartika .M. Deshmukh	9699720960	kartika.md20@gmail.com	
14.	Khushi .R. Pali	8767607224	PaliKhushi4@gmail.com	
15.	Nikita Bayapatne	8058625053	bayapatne25@gmail.com	
16.	Ashlesha Songole	9508998469	AshleshaSongole94@gmail.com	
17.	Dhannapathi R. Lale	9975037356	dhannapathiraj@gmail.com	
18.	Poojaal. Bhaya	8010434634	Poojwalb738@gmail.com	
19.	Trishabh Saha	7385310571	TrishabhSaha2004@gmail.com	
20.	Sania Midhat Kaya	8975726700	midhatania@gmail.com	
21.	Gargi Nadge	7972076671	garginadge@gmail.com	
22.	Vedant Baxy	8530455796	vedantbaxy@gmail.com	
23.	Nupur Sharma	9322042269	nupursharma288@gmail.com	
24.	Harshad warthi	7414993575	harshadwarthi0532@gmail.com	

Signature of:

Programme In-charge



IQA COORDINATOR
INTERNAL QUALITY ASSURANCE CELL
DHARAMPETH M. P. DEO MEMORIAL SCIENCE COLLEGE
NAGPUR

Principal
Dharampeth M.P. Deo Memorial
Science College, Nagpur.



Dharampeth M. P. Deo Memorial Science College, Nagpur
Academic Session: 2022-23

Criteria:

1)	Name of the Department	:	SPORTS AND PHYSICAL EDUCATION
2)	Name of the Activity	:	Inter-Collegiate Women Kabaddi tournament A Zone
3)	Date	:	10.10.2022
4)	Class	:	Graduate and Post Graduate
5)	Teacher In charge	:	Dr. Rahul Kalode
6)	Name of Chief Guest	:	Dr.Sanjay Dudhe Pro-VC RTMNU Nagpur and Dr.Sharad Suryavanshi, Director of Sports & Physical Education RTMNU Nagpur
7)	Topic	:	Inter-Collegiate Women Kabaddi tournament A Zone
8)	Venue	:	Dharampeth M. P. Deo Memorial Science College, Nagpur ground
9)	Number of students participated	:	13 teams (156 Students)
10)	DVV Format	:	NA
11)	Outcome	:	Students participated in sports , support their favourite team to create sports enrolment also interaction with famous sports personality
12)	Photos	:	
			



P. Kalode

Dr. Rahul D. Kalode
In-Charge
Deptt. of Physical Education
Dharampeth M.P. Deo Memorial
Science College, Nagpur

Name & Signature of Teacher In-Charge

N.P. Gaikwad

Dr. N.P. Gaikwad
IQAC Coordinator

IQAC Coordinator
Dharampeth M. P. Deo Memorial
Science College, Nagpur-440033

A. L. Peshwe

Dr. Akhilesh Peshwe
Principal
PRINCIPAL

Dharampeth M.P. Deo Memorial
Science College, Nagpur.



Rashtrasant Tukdoji Maharaj Nagpur University Nagpur
Office Of The Director, Sports & Physical Education

Inter Collegiate Kabaddi Women Tournament 2022-2023

DATE :- 10-10-2022 TO 13-10-2022

Zone	Name Teacher Incharge	Venue of Tournament	Mobile No.
A Zone	Dr. Rahul Kalote	Dharampath M. P. Geo Science College, Nagpur	9860552171
B Zone	Dr. Sushil Chavhan	Shri jajoo Giramin Sewa Mv, Pipri Wardha	9370267152
C Zone	Dr. Aruna Thool	S. G. B. Mahila Mahavidyalaya, Tumsar	9960374475
D Zone	Dr. Apurna Choudhari Shri. Palash Joshi	Smt. Binzeni Mahila Mahavidyalaya, Nagpur	7820609095
E Zone	Dr. Saureb Mohod	Shri. M. Wasnik P.W.S. College, Nagpur	9579117650
F Zone	Dr. Tejsingh Jagdale	Nabira Mahavidyalaya, Katol	9623338896
G Zone	Dr. Shashank Nikam	Dr. R. G. Bhoyar College, Seloo	9049932199
H Zone	Dr. Pravin Kumar	N. M. D. College, Gondla	9860367551

-< QUARTER FINAL MATCHS :-				Venue	Time	Date
1 st Quarter Final	Winner of A Zone	v/s	Winner of E Zone	Shri. M. Wasnik P.W.S. College, Nagpur	10.00 a.m.	12.10.2022
2 nd Quarter Final	Winner of B Zone	v/s	Winner of F Zone	Shri. M. Wasnik P.W.S. College, Nagpur	11.00 a.m.	12.10.2022
3 rd Quarter Final	Winner of C Zone	v/s	Winner of G Zone	Shri. M. Wasnik P.W.S. College, Nagpur	10.00 a.m.	12.10.2022
4 th Quarter Final	Winner of D Zone	v/s	Winner of H Zone	Shri. M. Wasnik P.W.S. College, Nagpur	11.00 a.m.	12.10.2022

-< SEMI-FINAL MATCHS :-				Venue	Time	Date
1 st Semi Final	Winner of 1 st Quarter Final	v/s	Winner of 3 rd Quarter Final	Shri. M. Wasnik P.W.S. College, Nagpur	3.00 p.m.	12.10.2022
2 nd Quarter Final	Winner of 2 nd Quarter Final	v/s	Winner of 4 th Quarter Final	Shri. M. Wasnik P.W.S. College, Nagpur	4.00 p.m.	12.10.2022

-< THIRD PLACE MATCHS :-				Venue	Time	Date
Losser of 1 st Semi Final	v/s	Losser of 2 nd Semi Final		Shri. M. Wasnik P.W.S. College, Nagpur	9.00 a.m.	13.10.2022

-< FINAL :-				Venue	Time	Date
Winner of 1 st Semi Final	v/s	Winner of 2 nd Semi Final		Shri. M. Wasnik P.W.S. College, Nagpur	10.00 a.m.	13.10.2022

SELECTION TRAIL KABADDI WOMEN 2022-2023

.Date of Selection Trails : 13-10-2022 to 15-10-2022
Date & Time of Reporting : 13-10-2022 at 02.00 p.m.
Venue of Selection Trails : Rashtrasant Tukdoji Maharaj Nagpur University Play Ground, Amravati Road, Nagpur
Incharge of Selection Trails : Dr. Savita Bhoyar (9890147308)

ZONE - A

VENUE :- DHARAMPETH M. P. DEO SCIENCE COLLEGE, NAGPUR
(TEACHER INCHARGE - DR. RAHUL KALODE)

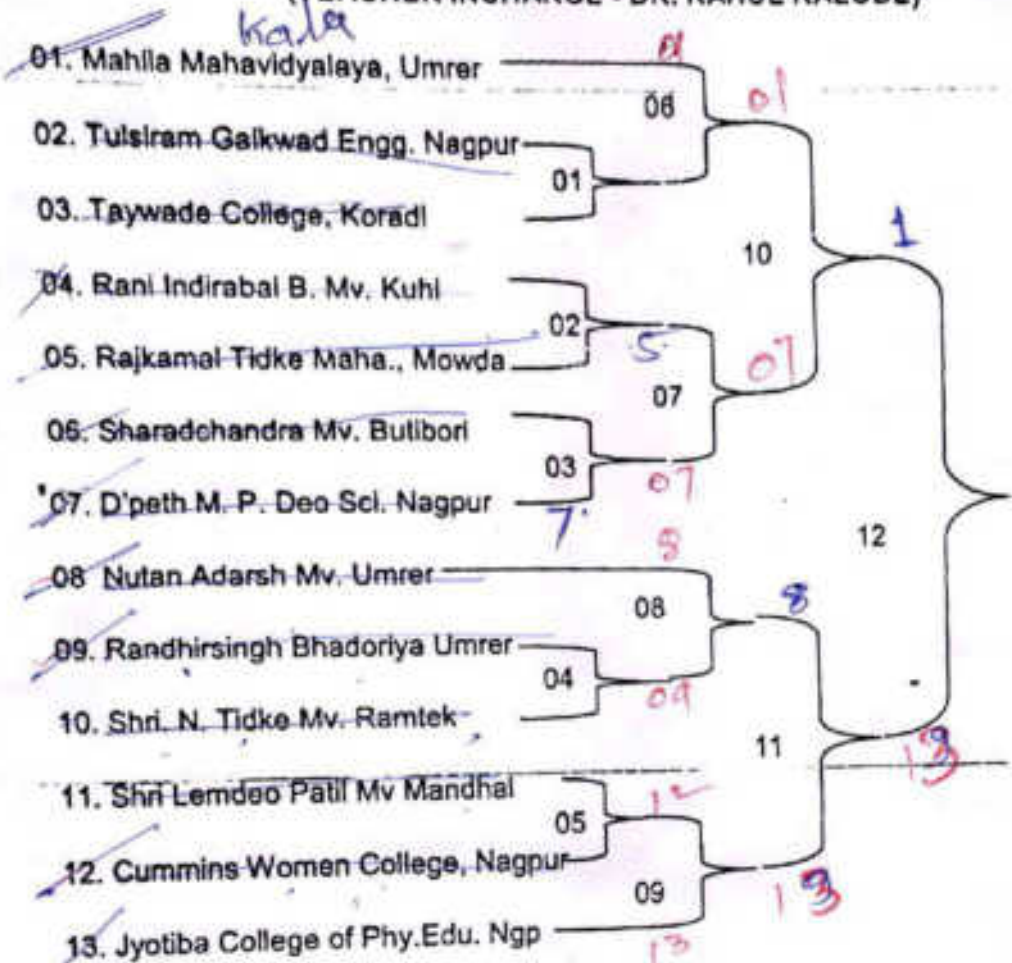

ZONE - B

VENUE :- JAJOO GIRAMIN SAVA MAHAVIDYALAYA, PIPRI
(TEACHER INCHARGE - DR. SUSHIL CHAVHAN)

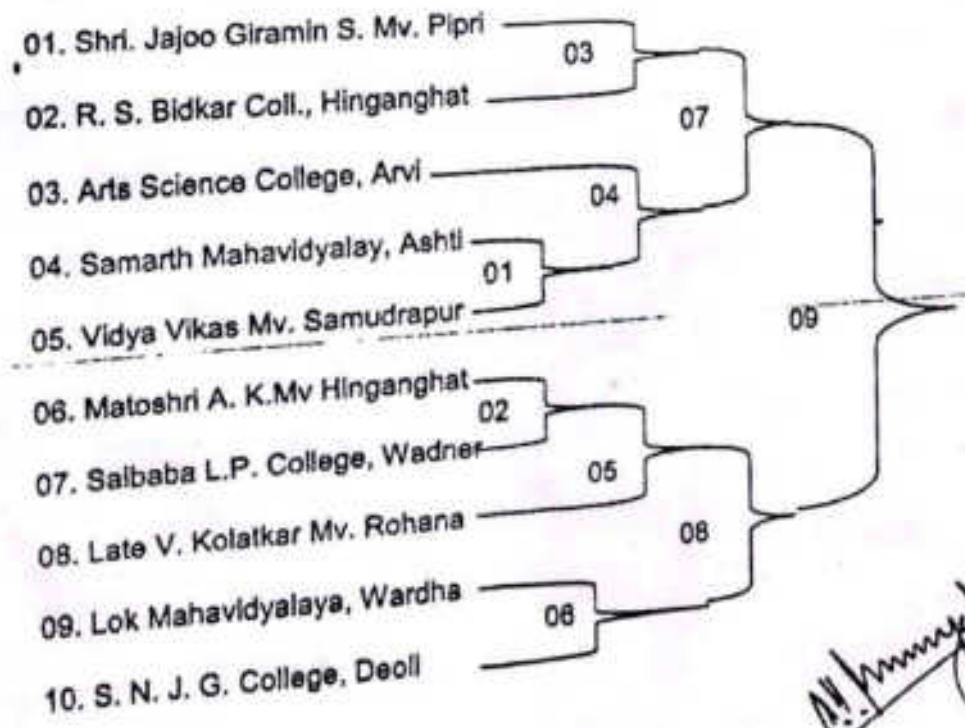

Handwritten signature: A. S. Chavhan

DATE & TIMING OF ZONE A TO H

Zone A		Zone D or E Zone		Zone H	
M.No.	Timing	M.No.	Timing	M. No.	Timing
Date 10.10.22		Date 10.10.22		Date 10.10.22	
01	08.00 a.m.	01	08.00 a.m.	01	08.00 a.m.
02	09.00 a.m.	02	09.00 a.m.	02	09.00 a.m.
03	10.00 a.m.	03	10.00 a.m.	03	10.00 a.m.
04	11.00 a.m.	04	11.00 a.m.	04	11.00 a.m.
05	12.00 noon	05	12.00 noon	05	12.00 noon
06	02.00 p.m.	06	02.00 p.m.	06	02.00 p.m.
07	03.00 p.m.	07	03.00 p.m.	07	03.00 p.m.
08	03.00 p.m.	08	03.00 p.m.	08	03.00 p.m.
09	04.00 p.m.	09	04.00 p.m.	09	04.00 p.m.
Date 11.10.22		Date 11.10.22		Date 11.10.22	
10	08.00 a.m.	10	08.00 a.m.	08	08.00 p.m.
11	09.00 a.m.	11	09.00 a.m.	09	09.00 p.m.
12	03.00 p.m.	12	11.00 a.m.	10	3.00 p.m.
Zone B		Zone F			
Date 11.10.22		Date 10.10.22			
01	08.00 a.m.	01	08.00 a.m.		
02	09.00 a.m.	02	09.00 a.m.		
03	10.00 a.m.	03	10.00 a.m.		
04	11.00 a.m.	04	11.00 a.m.		
05	12.00 noon	05	12.00 noon		
06	01.00 p.m.	06	01.00 p.m.		
Date 12.10.22					
07	08.00 a.m.	07	02.00 p.m.		
08	09.00 a.m.	08	03.00 p.m.		
09	03.00 p.m.				
Zone C		Date 11.10.22			
Date 11.10.22		09	08.00 a.m.		
01	09.00 a.m.	10	09.00 a.m.		
02	09.00 a.m.	11	03.00 p.m.		
03	10.00 a.m.				
		Zone G			
		Date 11.10.22			
04	11.00 a.m.	01	08.00 a.m.		
05	12.00 noon	02	09.00 a.m.		
06	01.00 p.m.	03	10.00 a.m.		
07	02.00 p.m.	04	11.00 a.m.		
08	03.00 p.m.	05	12.00 noon		
09	04.00 p.m.	06	01.00 p.m.		
Date 12.10.22		Date 12.10.22			
10	08.00 a.m.	07	08.00 a.m.		
11	09.00 a.m.	08	09.00 a.m.		
12	10.00 a.m.	09	03.00 p.m.		
13	11.00 a.m.				
14	03.00 p.m.				

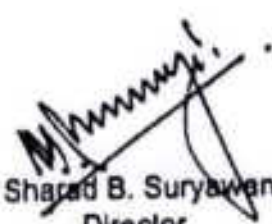
 Dr. Sharad B. Suryawanshi
 Director
 Sports & Physical Education
 Rashtrasant Tukdoji Maharaj
 Nagpur University Nagpur



DHARAMPETH M. P. DEO MEMORIAL SCIENCE COLLEGE, NAGPUR
INTERNAL QUALITY ASSURANCE CELL (IQAC)
Activity Report NEP

Date: 30/10/2022

Name of Organizing Department or Committee: Home science Department

Name of the activity: Preparation of High Protein Recipes

Suggested CRITERION point if any:

Date of Activity: 30/10/2022

Place of Activity: Home Science Department

Name of Guest Speaker/s or Judge/s or Chief Guest/s if any:

Title of the Activity: Preparation of High Protein Recipes

Number of Participants: 16

Name of the Teacher In-charge / Convener: Mrs Pradnya Bagalkote

Names of other Committee Members / Staff: HOD Manju Deshpande ma'am

OUTCOME of the Activity with respect to the mission vision of the institute and or academics:

Preparation of High Protein Recipes is useful of malnourished patients and helps to gain weight.

Activity with newspaper coverage if any:

Activity data save in PC of:

Note: Kindly share geotag photographs separately along with report on iqacdsc2022@gmail.com

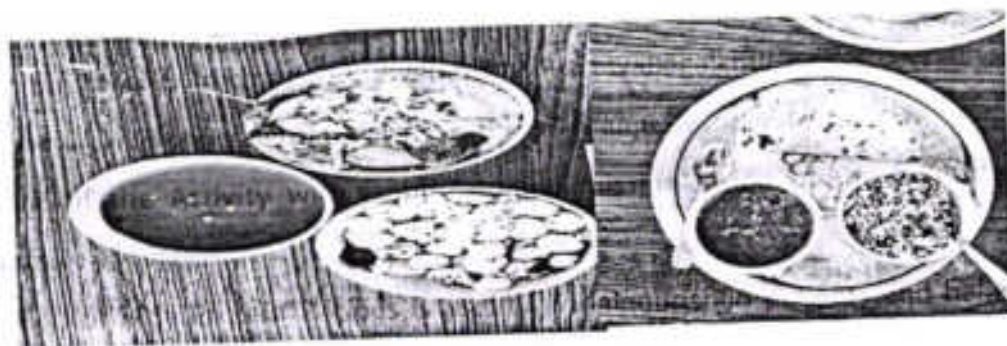

Prof. Pitambar Humane

CO-ORDINATOR

INTERNAL QUALITY ASSURANCE CELL
RAMPETH, M. P. DEO MEMORIAL &
SCIENCE COLLEGE, NAGPUR

Name & Signature of Teacher In-charge

Dr. Akhilesh Peshwe
Principal

Principal

Dharampeth M.P. Deo Memorial
Science College, Nagpur.

10/10/22



DHARAMPETH M. P. DEO MEMORIAL SCIENCE COLLEGE,
North Ambazari Road, Near Ambazari Lake, Nagpur- 440033

DATA VALIDATION & VERIFICATION (DVV)

H. Patekar Recipies.

	Name	Phone	Mail ID	Sign
1)	Shabnam. T. madali	9022302785	shabnammadali5@gmail.com	Shabnam
2)	Archita A Maske	9975034151	architamaskerachita@gmail.com	Archita
3)	Prachi N. Laxkar	9806044419	prachilaxkar159@gmail.com	Prachi
4)	Avani S. Shenwai	9096507459	avanshenwai@gmail.com	Avani
5)	Tamne S. Korde	7841984450	kordetamne13@gmail.com	Tamne
6)	Ojaswi Wankhede	8767699751	wankhedeojaswi@gmail.com	Ojaswi
7)	Kimaya N. Kale	8866073792	kimayakale005@gmail.com	Kimaya
8)	Pranavi Guwagadkar	9309079407	pranavogh@gmail.com	Pranavi
9)	Bhagyashree S Ambule	9359139058	ambulebh.s@gmail.com	Bhagvi
10)	Pallavi B. Patre	8459277408	patre513@gmail.com	Pallavi
11)	Vaishnavi. K. Pradhan	9763169560	pradhnavaisnavi15@gmail.com	Vaish
12)	Shwasti. S. Patekar	7387067403	shwastipatekar@gmail.com	Shwasti
13)	Riya. V. Mhatre	7350980307	mhatreriya23@gmail.com	Riya
14)	Deepika Jeydev	5709972162125	deepika@gmail.com	Deepika
15)	Sujata Kapse	9175451202	sujatakapse@gmail.com	Sujata
16)	Priya Khawshi	8763617224	Priyakhawshi3@gmail.com	Priya

Signature of:

- 17) Pragna S. Tiwari
- 18) Keshinath. Diwe

Programme In-charge
RB

6394098386
9284297798
IQAC Coordinator

CO-ORDINATOR
INTERNAL QUALITY ASSURANCE CELL
DHARAMPETH M. P. DEO MEMORIAL &
SCIENCE COLLEGE, NAGPUR

Pragnatiwari16052003@gmail.com
Keshinathdiwe@gmail.com

Principal

Dharampeth M.P. Deo Memorial
Science College, Nagpur.



**DHARAMPETH M. P. DEO MEMORIAL SCIENCE COLLEGE, NAGPUR
INTERNAL QUALITY ASSURANCE CELL (IQAC)**

Activity Report

Date: 10-10-2022

Name of Organizing Department or Committee: Department of Statistics.

Name of the activity: Determination of mean, median and mode.

Suggested CRITERION point if any:

Date of Activity: 10 october 2022

Place of Activity: Statistics lab

Name of Guest Speaker/s or Judge/s or Chief Guest/s if any:

Title of the Activity: Determination of mean, median and mode.

Number of Participants: 23

Name of the Teacher: Durga hingwe

Names of other Committee Members / Staff: N.A.

OUTCOME of the Activity with respect to mission vision of the institute and or academics:

From this activity students learn, mean is the average for a given set of data, median is the middle value of the data when arranged in ascending order and Mode is the value that occurs most in that data. Learning about mean, median, mode is an important concept to help build the students foundation for higher level of statistics.

Activity with newspaper coverage if any: No

Activity data save in PC of: Department of Statistics

Prof. Pitambar Humane
IQAC Coordinator

CO ORDINATOR
INTERNAL QUALITY ASSURANCE CELL
DHARAMPETH, M. P. DEO MEMORIAL &
SCIENCE COLLEGE, NAGPUR

Name & Signature of Teacher In-charge

Dr. Akhilesh Peshwe
Principal

Principal
Dharampeth M.P. Deo Memorial
Science College, Nagpur.



DHARAMPETH M. P. DEO MEMORIAL SCIENCE COLLEGE NAGPUR

Department of Statistics

Class: B.Sc. Sem.-I

NEP ACTIVITY

Paper- I

Unit- IV

Name of the Teacher: Durga C. Hingwe

Date: 10-10-2022

Title of Activity: Determination of mean, median and mode

Sr. No.	Name of Student	Batch	Mobile No.	Email ID	Signature
1.	Divyani Zagade	F2	9022866318	divyanizagade@gmail.com	DZagade
2.	Jainvi Khode	F2	7385066634	JainviKhode572@gmail.com	JKhode
3.	Pranali Dehanekar	F2	8767581278	PranaliDehanekar@gmail.com	PranaliDehanekar
4.	Nitika S. Kesurkar	F2	9490996645	nitika.s.kesurkar533@gmail.com	Nitika Kesurkar
5.	Utkasha S. Ingale	F2	7499159178	utkashasingale@gmail.com	UIngale
6.	Vidya Lohi	F2	7020963219	Vidyalohi@gmail.com	Vidya Lohi
7.	Sakshi Mishra	F2	9529889315	Sakshimishra439683@gmail.com	Sakshi Mishra
8.	Tanvi Kibbe	F2	846510539	Tanvikibbe4@gmail.com	Tanvi Kibbe
9)	Rutika Yadav	F2	8446085943	yadavrutika434@gmail.com	Rutika Yadav
10)	Mohit Khobekar	F2	8058328357	mohitkhobekar@gmail.com	Mohit Khobekar
11)	Veena Borikar	F2	9322016721	veena.borikar14@gmail.com	Veena Borikar
12)	Jankvi Joge	F2	7385060871	JankviJoge08@gmail.com	Jankvi Joge
13)	Pranali Gupta	F2	7020069377	pranali.gupta537@gmail.com	Pranali Gupta
14)	Jyoti Fullawar	F2	8767911807	Jyotifullawar@gmail.com	Jyoti Fullawar
15)	Sonia Niwal	F2	7058425021	niwalsonia70@gmail.com	Sonia Niwal
16)	Chetna Buije	F2	8010842968	buijetchetna@gmail.com	Chetna Buije
17)	Devashri Kakde	F2	7021344265	kakdedevashri@gmail.com	Devashri Kakde
18)	Jankvi Kienapure	F2	7058235243	Jankvikienapure@gmail.com	Jankvi Kienapure
19)	Pradnya Hirpude	F2	8010362232	pradnyahirpude914@gmail.com	Pradnya Hirpude
20)	Vivek S. Sah	F1	9923763071	Vivek.Sah1878@gmail.com	Vivek Sah
21)	Nayan N. Wathare	F1	7841870947	Nayanwathare7@gmail.com	Nayan Wathare
22)	Ishtikandeshpande	F2	9130091060	ishtikandeshpande21004@gmail.com	Ishtikandeshpande
23)	Varsha L. Turkar	F2	9373652950	varshaturkar458@gmail.com	Varsha L. Turkar

Durga C. Hingwe
Signature of Teacher

Durga C. Hingwe
Teacher Incharge



DHARAMPETH M. P. DEO MEMORIAL SCIENCE COLLEGE, NAGPUR
INTERNAL QUALITY ASSURANCE CELL (IQAC)

Activity Report

Date: 10-10-2022

Name of Organizing Department or Committee: Department of Statistics

Name of the activity: Drawing random sample from uniform and normal distribution.

Suggested CRITERION point if any:

Date of Activity: 10th October 2022

Place of Activity: Statistics lab

Name of Guest Speaker/s or Judge/s or Chief Guest/s if any:

Title of the Activity: Drawing random sample from uniform and normal distribution.

Number of Participants: 18

Name of the Teacher: Gauri Sinekar

Names of other Committee Members / Staff: N.A.

OUTCOME of the Activity with respect to mission vision of the institute and or academics:

Student get the knowledge about Uniform Distribution and Normal Distribution. How to draw the random sample from Uniform and Normal Distribution. How to analyse data of uniform and normal distribution. Students generate the random sample from Uniform and Normal distribution.

Activity with newspaper coverage if any: No

Activity data save in PC of: Department of Statistics.

Prof. Pitambar Humane
IQAC Coordinator

Name & Signature of Teacher In-charge

Dr. Akhifesh Peshwe
Principal

Principal
Dharampeth M.P. Deo Memorial
Science College, Nagpur

CO ORDINATOR
INTERNAL QUALITY ASSURANCE CELL
DHARAMPETH, M. P. DEO MEMORIAL &
SCIENCE COLLEGE, NAGPUR



DHARAMPETH M. P. DEO MEMORIAL SCIENCE COLLEGE NAGPUR

Department of Statistics

Class: B.Sc. Sem.- III

NEP ACTIVITY

Paper: I

Unit: III

Name of the Teacher: Gauri S. Sinekhar

Date: 10/10/2022

Title of Activity: Drawing random sample from uniform and normal distribution

Sr. No.	Name of Student	Batch	Mobile No.	Email ID	Signature
1.	Ketan S. Ghayor	Scom	9657957276	Ketan.ghayor53@gmail.com	
2.	Harshal N. Atankar	Scom	9527732358	Karshaliyanka8@gmail.com	H. N. Atankar
3.	Isha S. Nemade	Scom	7028494761	ishanemade.72@gmail.com	
4.	Vicky A. Singh	Scom	9834782331	vicky8singh11032001@gmail.com	
5.	Suman R. Singh	Scom	9322018536	SumanR.Singh123156789@gmail.com	
6.	Savit B. Singh	Scom	7252868502	savitbsingh@gmail.com	
7.	Prayakta Pawar	Scom	9356905759	prayakta@gmail.com	
8.	Swamini B. Rajankar	S.com	9822200598	Swaminirajankar@gmail.com	
9.	Purushotta Parasha	S.com	7020693071	parasha.purushotta@gmail.com	
10.	Aman D. Chavhan	S.com	7219496153	amanchavhan21@gmail.com	
11.	Arjeli V. Rangankar	S.com	8130037253	arjelirangankar@gmail.com	
12.	Vrushali Shohare	Scom	9307516332	vrushalishohare21@gmail.com	
13.	Purushotta Parasha	Scom	7020693071	parasha.purushotta@gmail.com	
14.	Saithak Jichkar	Scom	8605710878	Saithakjichkar@gmail.com	
15.	Avishkar A. Baneod	Scom	7820841782	avishkar.baneod@gmail.com	
16.	Sumit Sabdo	Scom	9322018536	sumitsabdo1256@gmail.com	
17.	Devang Karia	Scom	7888238500	devang@gmail.com	
18.	Khushi Waghade	Scom	9156520783	KhushiWaghade@gmail.com	
19.	Yasharni Sathav	Scom	9156910355	Y.Jo.8065930@gmail.com	

G. Sinekhar
Signature of Teacher

G. Sinekhar
Teacher Incharge



DHARAMPETH M. P. DEO MEMORIAL SCIENCE COLLEGE, NAGPUR

INTERNAL QUALITY ASSURANCE CELL (IQAC)

Activity Report

Date: 10/10/22

Name of Organizing Department or Committee: Department of Statistics

Name of the activity: Activity on control chart (X,R)

Suggested CRITERION point if any: Restricted to RTMNU BSc Statistics syllabus.

Date of Activity: 10/10/2022

Place of Activity: Statistics Lab

Name of Guest Speaker/s or Judge/s or Chief Guest/s if any: NA

Title of the Activity: Preparation of control chart (X,R) for a given data

Activity with newspaper coverage if any: No

Number of Participants: 20

Name of the: Ms. Kumudini Kadhe

Names of other Committee Members / Staff: N.A.

OUTCOME of the Activity with respect to academics:

By this activity students understood how to visualise continuous data using (X,R) chart. The X-bar helps to monitor the average or mean of the process average and how this changed over time. The R-chart shows the sample range, which represents the difference between the highest and lowest value in each sample.

DVV: Enclosed.

Activity data save in PC of: Lt. Dr. P. W. Ambekar

Prof. Pitambar Humane
IQAC Coordinator

COORDINATOR
INTERNAL QUALITY ASSURANCE CELL
DHARAMPETH, M. P. DEO MEMORIAL &
SCIENCE COLLEGE, NAGPUR

Name & Signature of Teacher In-charge

Dr. Akhilesh Peshwe
Principal

Principal
Dharampeth M.P. Deo Memorial
Science College, Nagpur



DHARAMPETH M. P. DEO MEMORIAL SCIENCE COLLEGE NAGPUR

Department of Statistics

Class: B.Sc. Sem.- V

NEP ACTIVITY

Paper- I

Unit- I

Name of the Teacher: Kumudini Kadbe

Date: 10/10/22

Title of Activity: Preparation of Control Chart (X, R) for a given data.

Sr. No.	Name of Student	Batch	Mobile No.	Email ID	Signature
1	Poochi Suresh ManuSmane	PSM	9356969609	poochimanusmane@q.com	
2	Himanshu Raju Lakhe	PSM	7448252469	himanshulakhe001@q.com	
3	Payush . Gajanan. Kapse	PSM	9373563027	Kapsepayush01@q.com	
4	Pratiksha .S. Thakre	PSM	8459570299	Pratikshathakre1709@gmail.com	
5	Divyani U. Dhule	PSM	7030731921	divyanidhule2002@gmail.com	
6	Uday P. Khandarkar	PSM	959587196	udaykhandarkar88@gmail.com	
7	Sakshi L. Barapatre	PSM	8317219372	sakshi2002bb@gmail.com	
8	Vaibhav S. Rane	PSM	7744957383	vaibhavrane2207@gmail.com	
9	Rahul .G. Chakradar	PSM	7620511383	Rahulchakradar1999@gmail.com	
10	Sumanabh V. Raut	Scom	9527282213	sumabhraut6725@gmail.com	
11	Rishikesh R. Dethre	Scom	8788199260	rishikeshdethre2002@gmail.com	
12	Vitthal V. Girkhale	Scom	9623681472	vitthalgirkhale2@gmail.com	
13	Neha S. Bunkar	Scom	8055477553	nehaz002bunkar@gmail.com	
14	Diya R. Patil	Scom	7757052043	diyapatil1533@gmail.com	
15	Sahil P. Jitade	Scom	9373414643	sahiljitade76@gmail.com	
16	Tanu S. Mahule	Scom	7057844982	tanumahule45@gmail.com	
17	Komal M Kumbhkar	Scom	7620314804	kumbhkar_komal94@gmail.com	
18	Sumrit Bhalerao	Scom	9021622757	sumritbhalerao262@gmail.com	
19	Pranjal D. Sureshkar	Scom	73656548510	pranjalSuresh1234@gmail.com	
20	Jasraj P. Patke	Scom	9622435044	Jasrajpatke2001@gmail.com	

Signature of Teacher

Teacher Incharge



DHARAMPETH M. P. DEO MEMORIAL SCIENCE COLLEGE, NAGPUR
INTERNAL QUALITY ASSURANCE CELL (IQAC)
NEP Activity Report

Date: 12/10/22

Name of Organizing Department or Committee: Chemistry Department

Name of the activity: NEP Activity Report (Sem-I, Unit-III)

Suggested CRITERION point if any: Criteria II

Date of Activity: 10/10/22

Place of Activity: Chemistry Department Laboratory

Name of Guest Speaker/s or Judge/s or Chief Guest/s if any: Nil

Title of the Activity: Identification of Melting and Boiling point of solids and liquids of various solvents

Number of Participants: 32

Name of the Teacher In-charge / Convener: Dr. Pranita Gawande, Niharika Sute

Names of other Committee Members / Staff: Dr. Vaishali Meshram

OUTCOME of the Activity with respect to mission vision of the institute and or academics:

This is student centric activity. In this activity students have learn the difference between Melting point and Boiling point. They have used Thiele's tube apparatus for this activity.



Activity with newspaper coverage if any: Nil

Activity data save in PC of: Chemistry Department

Note: Kindly share geotag photographs separately along with report on iqacdsc2022@gmail.com

Prof. Pitambar Humane
IQAC Coordinator

CO ORDINATOR
INTERNAL QUALITY ASSURANCE CELL
DHARAMPETH, M. P. DEO MEMORIAL &
SCIENCE COLLEGE, NAGPUR

Name & Signature of Teacher In-charge

Dr. Pranita Gawande

Dr. Akhilesh Peshwe
Principal

PRINCIPAL

Dharampeth M.P. Deo Memorial
Science College, Nagpur-440033



DHARAMPETH M. P. DEO MEMORIAL SCIENCE COLLEGE,
North Ambazari Road, Near Ambazari Lake, Nagpur-440033

DATA VALIDATION & VERIFICATION (DVV)

NEP Activity-3 on unit-III (sem-III)

Name of the Programme : Identification of Melting Point and Boiling Point of solids & liq. of various
Date of the Programme : Solvents 10/10/22
Name of Chief Guest if any :
Name of Guest Speaker if any :

Sr. No.	Name of the Participant	Mobile Number	E-mail Id	Signature
1.	Shital Patle	9764596377	ShitalPatle@gmail.com	SP
2.	Aakansha Mainal	8080923662	aakanshagogi2004@gmail.com	AK
3.	Manika Patel	7499225468	manikapatel7032@gmail.com	Manika Patel
4.	Pawan Thakre	8262969713	thakrePawan739@gmail.com	PT
5.	Durgesh Ghodmare	9075815618	durgeshghodmare01@gmail.com	durgesh
6.	Saibabsh Chaudhary	9359583501	Schaudhary559@gmail.com	S
7.	Shiram Patel	7035229083	SP040263@gmail.com	SP
8.	Karishma N. Pansad	9309318618	narenbra Pansad72@gmail.com	KP
9.	Pawan G. Thakre	8262969713	thakrepawan739@gmail.com	P.G. Thakre
10.	Ruchi Desaiwadi	8080776893	ruchi.desaiwadi@gmail.com	ruchie
11.	Ankit Patel	9970905638	ankitpatel99725@gmail.com	A. Patel
12.	Shreya Sha	8983236002	Scingretash030@gmail.com	Shreya
13.	Ritika Bhojari	9834587082	ritika Bhojari28@gmail.com	RP
14.	Aarjun Sharma	7020107398	arjun7010sharma@gmail.com	AJ

Signature of:
Programme In-charge

IQAC Coordinator
CO ORDINATOR
INTERNAL QUALITY ASSURANCE CELL
DHARAMPETH, M. P. DEO MEMORIAL &
SCIENCE COLLEGE, NAGPUR

Principal
PRINCIPAL
Dharampeth M.P. Deo Memorial
Science College, Nagpur-440033



DHARAMPETH M. P. DEO MEMORIAL SCIENCE COLLEGE,
North Ambazari Road, Near Ambazari Lake, Nagpur-440033

DATA VALIDATION & VERIFICATION (DVV)

154	Paitya Dubey (CBM (F13))	8669485362	dubey3ameshpaiya@gmail.com	P. Dubey
164	Aneksha D Katangale (F13)	9559455794	aneksha.katangale@gmail.com	Aneksha
174	Lucky A Vishwakarma (CB2F)	959549688186	lvishwakarma40@gmail.com	Lucky
184	Rohani H Meshram (CB2L)	9499956761	rohani.meshram43@gmail.com	Rohani
194	Samyak M. Hadke (CB212)	9020171304	samyakhadke93@gmail.com	Samyak Hadke
204	Jeet S Paradhi (CBM F14)	9020215431	jeetparadhi11@gmail.com	J. Paradhi
214	Ankit Patel	9970505638	ankitpatel79727@gmail.com	A. Patel
224	Shruti Channekar (F15)	9699823842	shrutichannekar@gmail.com	S. Channekar
234	Urnang Wadhvi (F15)	9322428500	urnangwadhvi@gmail.com	U. Wadhvi
244	Neha L. Wanjari (F15)	9373832260	nehawanjari783@gmail.com	N. Wanjari
25	Kastika M Deshmukh	9693720760	kastikaand20@gmail.com	K. Deshmukh
26	Pooja B Bilen (F15)	8483054339	poojabilen254@gmail.com	P. Bilen
27	Pratisha M. Meshram (F15)	8459070338	meshrampratiksi17@gmail.com	P. Meshram
28	Pranali Y. Chauhan (F15)	9699654562	pranalic Chauhan@gmail.com	P. Chauhan
29	Yashona K Pandey	9156035297	pandeykristy@gmail.com	Y. Pandey
30	Paitya B Sharma	8010764549	paitya02004sharma@gmail.com	P. Sharma
31	Nisha V. Pandey (CBM)	8665231390	Abhishek 8665231390@gmail.com	N. Pandey
32	Asiya S. Hussain	935925974	mansuri Hussain 5154@gmail.com	Asiya Hussain

Signature of:

Programme In-charge

IQAC Coordinator

CO ORDINATOR
INTERNAL QUALITY ASSURANCE CELL
DHARAMPETH, M. P. DEO MEMORIAL &
SCIENCE COLLEGE, NAGPUR

Principal

PRINCIPAL
Dharampeth M.P. Deo Memorial
Science College, Nagpur-440033



DHARAMPETH M. P. DEO MEMORIAL SCIENCE COLLEGE, NAGPUR
INTERNAL QUALITY ASSURANCE CELL (IQAC)

Date: 10/10/2022

Name of Organizing Department or Committee: Home Science Department

Name of the activity: Demonstration on paper Lamps (NEP Activity)

Suggested CRITERION point if any: Criteria II & V

Date of Activity: 10/10/2022

Place of Activity: Classroom

Name of Guest Speaker/s or Judge/s or Chief Guest/s Resource Person if any: Ms. Ankita Wankhede

Title of the Activity: Paper Lamp

Number of Participants: 11 students of Semester Ist participate in the activity.

Name of the Teacher In-charge / Convener: Ms. Ankita Wankhede

Names of other Committee Members / Staff: Mrs. Manju Deshpande

OUTCOME of the Activity with respect to mission vision of the institute and or academics:

1. They learn to create something new and décor home in Diwali Festival.
2. This activity build confidence in students they can start her own small business and generate employment.
3. From this activity students learn about the elements of art, relation of colour combination, balance etc.

Activity with newspaper coverage if any: _____

Activity data save in PC of: Home Science Staff Room Desktop

Note: Kindly share geotag photographs separately along with report on iqaedsc2022@gmail.com



[Handwritten Signature]

COORDINATOR

INTERNAL QUALITY ASSURANCE CELL
IQAC Coordinator
DHARAMPETH M.P. DEO MEMORIAL & SCIENCE COLLEGE, NAGPUR

[Handwritten Signature]

Name & Signature of Teacher In-charge

Dr. Akhilesh Peshwe

PRINCIPAL

Dharampeth M.P. Deo Memorial Science College, Nagpur-440033



DHARAMPETH M. P. DEO MEMORIAL SCIENCE COLLEGE,
North Ambazari Road, Near Ambazari Lake, Nagpur-440033

DATA VALIDATION & VERIFICATION (DVV)

Name of the Programme

: Demonstration on Paper Lamp (NEP Activity)

Date of the Programme

: 10/10/22

Name of Chief Guest if any

: _____

Name of Guest Speaker if any

: _____

Sr. No.	Name of the Participant	Mobile Number	E-mail Id	Signature
1.	Prerna J. Choudhari	7620384149	choudhariprerna294@gmail.com	Prerna
2.	Anshikha U. Jaiswarakar	9021391207	anshikhajaiswarakar@gmail.com	Anshikha
3.	Minal L. Patil	7350730164	patilminal83@gmail.com	Minal
4.	Shalvi Paudyal	8329115980	shalvipaudyal@gmail.com	Shalvi
5.	Gayatri S. N. Varma	9763287531	gayatrivarma26@gmail.com	Gayatri
6.	Hemlata D. Verma	8514058329	varmahemlata79@gmail.com	Hemlata
7.	Bhavana Gusudasoni	8888437303	bhavonagusudasoni@gmail.com	Bhavana
8.	Aditi R. Vaidya	9075714591	aditivaidya619@gmail.com	Aditi
9.	Ashwani Pandey	8308621020		Ashwani
10.	Satishi Chakunde	7813018801		Satishi Chakunde

Signature of:

Anchal Lokande

Programme In-charge

Mr. Ankita Lokande

COORDINATOR

INTERNAL QUALITY ASSURANCE CELL
IGAC Coordinator
DHARAMPETH M. P. DEO MEMORIAL &
SCIENCE COLLEGE, NAGPUR

Principal

Principal
PRINCIPAL

Dharampeth M.P. Deo Memorial
Science College, Nagpur-440033



DHARAMPETH M. P. DEO MEMORIAL SCIENCE COLLEGE, NAGPUR

INTERNAL QUALITY ASSURANCE CELL (IQAC)

Activity Report

Date: 30.10.2022

Name of Organizing Department or Committee: Dept. of Home Science

Name of the activity: Pictorial Demonstration of Family Planning Devices (NEP 2022 Activity)

Suggested CRITERION point if any:

Date of Activity: 11.10.2022

Place of Activity: Classroom, Dept. of Home Science

Name of Guest Speaker/s or Judge/s or Chief Guest/s if any:

Title of the Activity: Pictorial Demonstration of Family Planning Devices

Number of Participants: 15

Name of the Teacher In-charge / Convener: Mrs. Meghna Pandit

Names of other Committee Members / Staff:

OUTCOME of the Activity with respect to mission vision of the institute and or academics:

To develop understanding of choices of family planning devices, their working, importance and availability.

Activity with newspaper coverage if any:

Activity data save in PC of:

Note: Kindly share geotag photographs separately along with report on iqaedsc2022@gmail.com

Prof. Pitambar Humane
IQAC Coordinator

CO ORDINATOR
INTERNAL QUALITY ASSURANCE CELL
DHARAMPETH M. P. DEO MEMORIAL &

Name & Signature of Teacher In-charge
(Mrs. Meghna Pandit)
Head Department of Home Science
Dharampeth M. P. Deo Memorial
Science College, Nagpur

Dr. Akhilesh Peshwe
Principal
PRINCIPAL
DHARAMPETH M. P. DEO
MEMORIAL SCIENCE COLLEGE
NAGPUR



DHARAMPETH M. P. DEO MEMORIAL SCIENCE COLLEGE,
North Ambazari Road, Near Ambazari Lake, Nagpur-440033

DATA VALIDATION & VERIFICATION (DVV)

Name of the Programme : Pictorial Demonstration of Family Planning Devices
Date of the Programme : 11/10/2022
Name of Chief Guest if any : _____
Name of Guest Speaker if any : _____

Sr. No.	Name of the Participant	Mobile Number	E-mail Id	Signature
1.	Mayuri Ch. Mali	7498065023	mayurimali123@gmail.com	<u>Mayuri</u>
2.	sakshi Thosar	8177911360	sakshithosar620@gmail.com	<u>SThosar</u>
3.	Vaishnavi Bahadure	9284679244	vaishnavibahadure34@gmail.com	<u>Vbahadure</u>
4.	Mahima Wankhed	7821883251	mahimawankhed7@gmail.com	<u>Mahi</u>
5.	Puandali Raut	9120117015	PuandaliRaut567@gmail.com	<u>Puandali</u>
6.	sakshi Thosar	8177911360	sakshithosar620@gmail.com	<u>SThosar</u>
7.	Vaishnavi Upasak	9975287431	upasakvaishnavi@gmail.com	<u>Vupasak</u>
8.	Renuka Raut	8855972285	rautrenuka85@gmail.com	<u>Renuka</u>
9.	Riya Sheekar	724070278	sheekar.oriya@gmail.com	<u>Riya</u>
10.	Vanshika Todase	7447275658	vanshikatodase@gmail.com	<u>Vanshika</u>

Signature of:
Pandit
Programme In-charge

Pandit
CO ORDINATOR
INTERNAL QUALITY ASSURANCE CELL
DHARAMPETH, M. P. DEO MEMORIAL &
SCIENCE COLLEGE

Pandit
PRINCIPAL
Dharampeth M. P. Deo Memorial
Science College, Nagpur-440033



DHARAMPETH M. P. DEO MEMORIAL SCIENCE COLLEGE, NAGPUR
INTERNAL QUALITY ASSURANCE CELL (IQAC)

Activity Report

Date: 11-10-2022

Name of Organizing Department or Committee: Department of Statistics

Name of the activity: Application of Chi – Square(χ^2) and Goodness of fit test

Suggested CRITERION point if any:

Date of Activity: 11th October 2022

Place of Activity: Statistics lab

Name of Guest Speaker/s or Judge/s or Chief Guest/s if any:

Title of the Activity: Application of Chi-Square(χ^2) distribution and Goodness of fit test

Number of Participants: 18

Name of the Teacher: Gauri Sinekar

Names of other Committee Members / Staff: N.A.

OUTCOME of the Activity with respect to mission vision of the institute and or academics:

Student get the knowledge about Chi-Square(χ^2) Distribution. With the help of Application of Chi-Square (χ^2)- Goodness of fit test, student know that desire distribution fit to given data or not. How to analyse data of distribution of digits in number chosen at random from a telephone directory.

Activity with newspaper coverage if any: No

Activity data save in PC of: Department of Statistics

Prof. Pitambar Humane
IQAC Coordinator

Name & Signature of Teacher In-charge

Dr. Akhilesh Peshwe
Principal

CO ORDINATOR
INTERNAL QUALITY ASSURANCE CELL
DHARAMPETH M. P. DEO MEMORIAL &
SCIENCE COLLEGE, NAGPUR

Dharampeth M.P. Deo Memorial
Science College, Nagpur.



DHARAMPETH M. P. DEO MEMORIAL SCIENCE COLLEGE NAGPUR

Department of Statistics

Class: B.Sc. Sem. - III

NEP ACTIVITY

Paper: I

Unit: IV

Name of the Teacher: Gauri S. Sinekar

Date: 11/10/2022

Title of Activity: Application of χ^2 (Chi-square) statistics and Goodness of fit test.

Sr. No.	Name of Student	Batch	Mobile No.	Email ID	Signature
1.	Ketan S. Bhojale	Scom	9657957276	Ketanbhojale59@gmail.com	
2]	Harshal N. Atinkar	Scom	9527732358	harshalatinkar@gmail.com	
3]	Isha S. Nemade	Scom	7028494761	ishanemade72@gmail.com	
4]	Vicky A. Singh	Scom	9834782931	vicky.singh1092001@gmail.com	
5]	Suman R. Singh	Scom	932218536	sumanrsingh2345678@gmail.com	
6]	Sahil B. Singh	S.com	7258868802	sahilbsingh@gmail.com	
7]	Prajakta Pawar	Scom	9356905759	prajakta2404@gmail.com	
8]	Pragya Swamini Rajput	S.com	9822200598	swaminirajputa2003@gmail.com	
9]	Aman D. Charhan	S.com	7219486155	amancharhan@gmail.com	
10]	Anjali V. Rangankar	S.com	8830031253	anjali.rangankar42@gmail.com	
11]	Vrushali Shohare	Scom	9307516332	vrushali.shohare25@gmail.com	
12]	Pooleshottam Parashar	Scom	7020693071	parasharpurush@gmail.com	
13]	Saarthak Jichkar	Scom	8605710878	saarthakjichkar@gmail.com	
14]	Arishtak A. Banerjee	Scom	7570547888	arishtakbanerjee02@gmail.com	
15]	Swarnit Sabale	Scom	9222405588	swarnitsabale0255@gmail.com	
16]	Devang Khatia	Scom	7888238500	devang@gmail.com	
17]	Khushi Waghade	Scom	9156520783	khushiwaghade@gmail.com	
18]	Veishnavi Tulkar	Scom	9156916955	veishnavitulkar@gmail.com	

G. Sinekar
Signature of Teacher

G. Sinekar
Teacher Incharge



DHARAMPETH M. P. DEO MEMORIAL SCIENCE COLLEGE, NAGPUR
INTERNAL QUALITY ASSURANCE CELL (IQAC)
NEP Activity Report

Date:31/10/2022

Name of Organizing Department or Committee: Chemistry

Name of the activity: NEP Activity Report (Sem I, paper II, Unit III-Liquid State)

Suggested CRITERION point if any: Criteria II

Date of Activity: 11-10-2022

Place of Activity: Department of Chemistry Classroom

Name of Guest Speaker/s or Judge/s or Chief Guest/s if any- Nil

Title of the Activity: Model making for Liquid Crystals and Seven segment cell

Number of Participants: 41

Name of the Teacher In-charge / Convener: Dr. Mrs. Yogita Morey (Dahire)

Names of other Committee Members / Staff: Dr. Mrs. V. P. Meshram

OUTCOME of the Activity with respect to mission vision of the institute and or academics:

This is a student's centric activity. Model making for Liquid crystal and seven segment cell. Liquid crystals are of three types which are smectic, nematic and cholesteric liquid crystal. Liquid crystal occupy the middle ground between crystalline solids and ordinary liquids with regards to symmetry energy and properties. These activities clears the concept of students visually.



Activity with newspaper coverage if any: Nil

Activity data saved in PC of: Chemistry Department

Note: Kindly share Jio tag photographs separately along with report on igacdsc2022@gmail.com

Prof. Pitambar Humane
IQAC Coordinator

CO ORDINATOR
INTERNAL QUALITY ASSURANCE CELL
DHARAMPETH, M. P. DEO MEMORIAL &
SCIENCE COLLEGE, NAGPUR

Name & Signature of Teacher In-charge
Dr. Mrs. Yogita Morey (Dahire)

Dr. Akhilesh Peshwe
Principal

PRINCIPAL

Dharampeth M. P. Deo Memorial
Science College, Nagpur-440033



DHARAMPETH M. P. DEO MEMORIAL SCIENCE COLLEGE,
North Ambazari Road, Near Ambazari Lake, Nagpur-440033

DATA VALIDATION & VERIFICATION (DVV)

Name of the Programme : Activity-3 on Unit-3
Chart making for Liquid crystals and seven segment cell
Date of the Programme : 11-10-2022
Name of Chief Guest if any : _____
Name of Guest Speaker if any : _____

Sr. No.	Name of the Participant	Mobile Number	E-mail Id	Signature
1.	Ruchi divedi	8080776893	Ruchivedi23@gmail.com	(Ruchi)
2.	Saurabh Chaudhary	9359883501	Schaudhary5599@gmail.com	(Saurabh)
3.	Ritika bhoyar	983458187	Ritikabhoyar28@gmail.com	(Ritika)
4.	Menika I. Patel	7499225468	MenikaPatel1025@gmail.com	(M. Patel)
5.	Karishma N. Prasad	9309318667	narendraprasad72@gmail.com	(Karishma)
6.	Pratibha Bhusari	7821048413	pbhusari748@gmail.com	(P. Bhusari)
7.	Shital O. Patle	9764596337	shitalpatle@gmail.com	(Shital)
8.	Ankit Patle	9970905739	ankitpatel7972@gmail.com	(Ankit)
9.	Saurabh Chaudhary	9359883501	Schaudhary5599@gmail.com	(Saurabh)
10.	Shivam Patel	703888983	si040265@gmail.com	(Shivam)
11.	Durgesh K. Ghodmare	9075318618	durgeshghodmare001@gmail.com	(Durgesh)
12.	Pawan E. Thakre	8262963713	Thakare Pawan735@gmail.com	(P. Thakre)
13.	Mrunali D. Bhilkar	9322727616	MrunaliBhilkar@gmail.com	(M. Bhilkar)
14.	Nihal V. Meshram	9322727116	Nihalmeshram@gmail.com	(Nihal)

Signature of: 
Programme In-charge

(Dr Mrs Yogita Morey (Dahire))

IQAC Coordinator

CO ORDINATOR
INTERNAL QUALITY ASSURANCE CELL
DHARAMPETH, M. P. DEO MEMORIAL &
SCIENCE COLLEGE, NAGPUR

Principal

PRINCIPAL
Dharampeth M. P. Deo Memorial
Science College, Nagpur-440033



DHARAMPETH M. P. DEO MEMORIAL SCIENCE COLLEGE,
North Ambazari Road, Near Ambazari Lake, Nagpur - 440033

DATA VALIDATION & VERIFICATION (DVV)

15	Nikhil R. Kumar	8262969713	Nikhil.kumar@gmail.com	Nan
16	Apeksha D Kotangale	7559455794	apekshakotangale26@gmail.com	Apotangale
17	Pranali Chaudhary	9695654562	pranalic@rediffmail.com	Pranali
18	Neha Wanjari	9373832266	nehawanjari73@gmail.com	NWanjari
19	Sumaina Chichonde	8530970132	sumainachichonde@gmail.com	Chichonde
20	Ashlesha Khadgi	7820929579	Ashlesha.khadgi@gmail.com	Ashlesha
21	Krutika Pokale	9021533341	PokaliKrutika@gmail.com	Krutika
22	Gunjan Bhojar	8668335876	gunjanbhojar34@gmail.com	Gunjan
23	Gauri R. Bhojar	7666799586	Gauribhojar@gmail.com	Gauri
24	Vaishnavi + Ongi	8421657945	Vaishnavi.ongi2004@gmail.com	Vaishnavi
25	Maheshwari Bhakar	9092137975	MaheshwariBhakar@gmail.com	Bhakar
26	Aakansha Y. Mairal	8010923662	aakanyagi2004@gmail.com	Aakansha
27	Raj Meshram	9529927031	Rajmeshram14@gmail.com	Raj
28	Khushi Bharti	9604367894	2005khushibharti@gmail.com	Khushi
29	Nikita Das	8446297880	Nikitadas970@gmail.com	Nikita
30	Yashana Pandey	9156035237	Pandey.kris4@gmail.com	Yashana
31	Priya Sharma	8010764549	priyaxi2007sharma@gmail.com	Priya
32	Nisha Pandey	8605231390	Abhishek8605231390@gmail.com	Nisha
33	Abhay P. Tembhare	89575363145	abhay230102@gmail.com	Abhay
34	Leelkay A. Vishwakarma	9579660186	leelshwarkar24@gmail.com	Leelkay
35	Kiran K. Ghuguskar	9021231007	Ghuguskar.Kiran2004@gmail.com	Kiran

Signature of:
Programme In-charge

Dr. Mrs. Yogita Morey (Deure)

ICAC Coordinator

COORDINATOR
INTERNAL QUALITY ASSURANCE CELL
DHARAMPETH, M. P. DEO MEMORIAL &
SCIENCE COLLEGE, NAGPUR

Principal

PRINCIPAL

Dharampeth M.P. Deo Memorial
Science College, Nagpur-440033



DHARAMPETH M. P. DEO MEMORIAL SCIENCE COLLEGE, NAGPUR

INTERNAL QUALITY ASSURANCE CELL (IQAC)

Activity Report

Date: 12/10/2022

Name of Organizing Department or Committee: Department of Physics

Name of the activity: NEP based Demonstration Activity for B.Sc. Sem-I

Suggested CRITERION point if any: Restricted to RTMNU BSc physics syllabus.

Date of Activity: 12/10/2022

Place of Activity: Room no. 10

Name of Guest Speaker/s or Judge/s or Chief Guest/s if any: NA

Title of the Activity: Static charges attraction and repulsion

Activity with newspaper coverage if any: No

Number of Participants: BSc Sem-I Students – 10

Name of the Teacher In-charge / Convener: Mr. Roshan B. Raut

Names of other Committee Members / Staff: N.A.

OUTCOME of the Activity with respect to academics:

The present BSc Sem-I students made to learn the phenomenon of Static charges attraction and repulsion. In this activity a plastic pen was rubbed on the hairs for a 30 second and when the pen was kept near the small sized paper pieces. They got attracted towards it. This demonstration helped students to understand the concept of Static charges attraction and repulsion clearly.

DVV: Enclosed.

Activity data save in PC of: Lt. Dr. P. W. Ambekar

Prof. Pitambar Humane
IQAC Coordinator

CO ORDINATOR
INTERNAL QUALITY ASSURANCE CELL
DHARAMPETH, M. P. DEO MEMORIAL &
SCIENCE COLLEGE, NAGPUR

Name & Signature of Teacher In-charge

Dr. Akhilesh Peshwe
Principal
Principal
Dharampeth M.P. Deo Memorial
Science College, Nagpur.



DHARAMPETH M. P. DEO MEMORIAL SCIENCE COLLEGE, NAGPUR
INTERNAL QUALITY ASSURANCE CELL (IQAC)
NEP Activity Report

Date: 19/10/2022

Name of Organizing Department or Committee: Chemistry
Name of the activity: NEP Activity Report (Sem I, paper II, Unit IV)
Suggested CRITERION point if any: Criteria II
Date of Activity: 12-10-2022
Place of Activity: Department of Chemistry
Name of Guest Speaker/s or Judge/s or Chief Guest/s if any- Nil
Title of the Activity: Use of Adsorption in various processes
Number of Participants: 40
Name of the Teacher In-charge / Convener: Dr. Mrs. Mrudul R. Keskar
Names of other Committee Members / Staff: Dr. Mrs. V. P. Meshram

OUTCOME of the Activity with respect to mission vision of the institute and or academics:

This is a student's centric activity. Adsorption is a surface phenomenon. Occurrence of this phenomenon is due to the physical and chemical bond. Charcoal removes colour of solution by adsorbing impurities. For example- In manufacturing of sugar, colour of the solution is clarified by treating it with charcoal to remove impurity. This can easily visualized and the students understanding and idea about adsorption had been cleared.

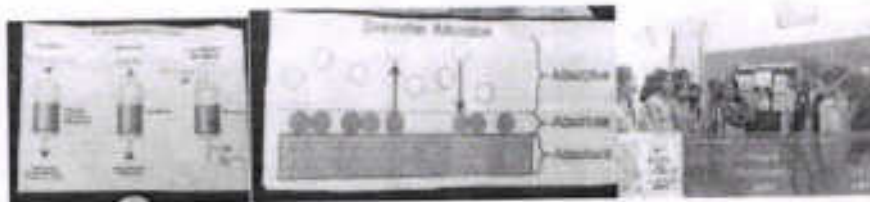

Activity with newspaper coverage if any: Nil
Activity data saved in PC of: Chemistry Department

Note: Kindly share Jio tag photographs separately along with report on iqacds2022@gmail.com

Prof. Pitambar Humane
IQAC Coordinator
CO ORDINATOR
INTERNAL QUALITY ASSURANCE CELL
DHARAMPETH, M. P. DEO MEMORIAL &
SCIENCE COLLEGE, NAGPUR

keskar.
Name & Signature of Teacher In-charge
(Dr. Mrs. Mrudul R. Keskar)

Dr. Akhilesh Peshwe
Principal

PRINCIPAL
Dharampeth M.P. Deo Memorial
Science College, Nagpur-440033



DHARAMPETH M. P. DEO MEMORIAL SCIENCE COLLEGE,
North Ambazari Road, Near Ambazari Lake, Nagpur-440033

DATA VALIDATION & VERIFICATION (DVV)

Name of the Programme : NEP Activity (Use of Adsorption in various processes) (sem I, page-II unit IV)
 Date of the Programme : 12-10-2022
 Name of Chief Guest if any : -
 Name of Guest Speaker if any : -

Sr. No.	Name of the Participant	Mobile Number	E-mail Id	Signature
1.	Shital Patle	9264596337	shitalpatle12@gmail.com	
2.	monika. patel	7499225468	monikapatel1088@gmail.com	
3.	Ankit Patel	9970905638	ankitpatel78775@gmail.com	
4.	Ritika Bhojar	9884587087	ritikabhoyar28@gmail.com	
5.	^{Saurabh Chaudhry} Ruchi Dwivedi	9359883501	schaudhry5599@gmail.com	
6.	Aakansha mairal	8030923662	aakuyogi2009@gmail.com	
7.	Ruchi dwivedi	8080776899	Ruchidwivedi230@gmail.com	
8.	Karishma .N. Parasad	9309318667	narendrparasad72@gmail.com	
9.	Durgesh K. Ghodmare	907538618	durgeshghodmare011@gmail.com	
10.	Nihal V. Meshram	9922424616	nihaimeshram0414@gmail.com	
11.	Mrunali Bhikson	9922424616	MrunaliBhikson@gmail.com	
12.	Shivam Patel	7038889083	Sp040263@gmail.com	
13.	Pratibha bhusari	7821048413	pibhusari71@gmail.com	
14.	Saurabh Chaudhry	9359883501	Schaudhry5599@gmail	

Signature of:
 Programme In-charge

(Dr) Mrs. Mridul R. Keskar

CO-ORDINATOR

INTERNAL QUALITY ASSURANCE CELL
 DHARAMPETH, M. P. DEO MEMORIAL &
 SCIENCE COLLEGE, NAGPUR

PRINCIPAL

Dharampeth M. P. Deo Memorial
 Science College, Nagpur-440033



DHARAMPETH M. P. DEO MEMORIAL SCIENCE COLLEGE,
North Ambazari Road, Near Ambazari Lake, Nagpur-440033

DATA VALIDATION & VERIFICATION (DVV)

15	Poojan G. Thakre	8262969713	thakreppavan739@gmail.com	P.G. Thakre
16	Nikhil R. Kumbhar	8262969713	nikhilkumbhar@gmail.com	NB
17	Ashateka Khadgi	8830414284	ashateka@gmail.com	A
18	Gunjan Bhojar	7666799026	gunjanbhojar@gmail.com	Gunjan Lucy
19	Lucy Vishwakarma	9579660186		
20	Pooja Bisen	8483097439	poojabisen37@gmail.com	PS
21	Amrita Anand	7666554171		Amrita
22	Kastika Deshmukh	9699720960	kastikadeshmukh@gmail.com	Kastika
23	Meha Rajagaoth	9373822666		Meha
24	Vaidhi Thate	7558499199	vaidhitthate@gmail.com	Vaidhi
25	Jeet Padhi	7070215631	jeetpadhi@gmail.com	Jeet
26	Khushi Rewade	9588665994	khushiRewade@gmail.com	Khushi
27	Shruti Chandelan	9699828862	shrutichandelan@gmail.com	Shruti
28	Ankit Patel		ankitpatel@gmail.com	Ankit
29	Monika I. Patel		monikapatel@gmail.com	Monika
30	Ritika Bhojar	9834587057	ritikabhojar@gmail.com	Ritika
31	Syjal Kolhe	8483045985	syjalKolhe@gmail.com	Syjal
32	Dhanashri Mewase	9359909913	dhanashrimewase@gmail.com	Dhanashri
33	Rashi R. Sapare	0145486983	rashisapare77@gmail.com	Rashi
34	Vaidhavi Denge	7058437240		Vaidhavi
35	Sapary Choudhary	8768852661		Sapary

Signature of: afeskar
Programme in-charge

(Dr. Mrs. Prasadul R. Keskar)

IQAC Coordinator
CO-ORDINATOR

INTERNAL QUALITY ASSURANCE CELL
DHARAMPETH, M. P. DEO MEMORIAL &
SCIENCE COLLEGE, NAGPUR

Principal
PRINCIPAL

Dharampeth M. P. Deo Memorial
Science College, Nagpur-440033



DHARAMPETH M. P. DEO MEMORIAL SCIENCE COLLEGE, NAGPUR

**INTERNAL QUALITY ASSURANCE CELL (IQAC)
Activity Report**

Date: 13/10/2022

Name of Organizing Department or Committee: Department of Physics

Name of the activity: Aptitude Test for B. Sc. Semester I

Suggested CRITERION point if any:

Date of Activity: 13/10/2022

Place of Activity: Physics Laboratory (Online mode)

Name of Guest Speaker/s or Judge/s or Chief Guest/s if any: NA

Title of the Activity: Physics Aptitude Test

Activity with newspaper coverage if any: No

Number of Participants: 75

Name of the Teacher In-charge / Convener: Lt. Dr. P. W. Ambekar

Names of other Committee Members / Staff: Dr. S. K. Ubale

OUTCOME of the Activity with respect to mission vision of the institute and or academics:

The activity is a regular feature of the department. It shows the students depth in subject related basic knowledge. It helps teachers to engage slow and fast learners apart from the regular general teaching. It also help teachers and evaluating staff to find innovative learners

DVV: Enclosed.

Activity data save in PC of: Lt. Dr. P. W. Ambekar

Prof. Pitambar Humane
IQAC Coordinator
PROF. PITAMBAR T. HUMANE
IQAC Co-ordinator
Dharampeth M.P. Deo Memorial
Science College, Nagpur-440033

Name & Signature of **HEAD** Teacher In-charge

DEPARTMENT OF PHYSICS
Dharampeth M. P. Deo Memorial
Science College, Nagpur

Dr. Akhilesh Peshwe
Principal
PRINCIPAL
Dharampeth M. P. Deo Memorial
Science College, Nagpur.

Average
14.3% / 30 points

Median
14 / 30 points

Range
6 - 24 points

Total points distribution

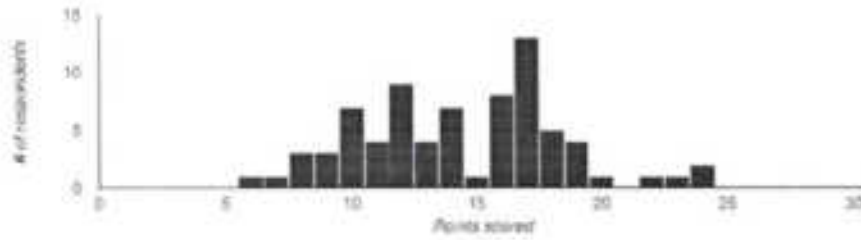

Class
75 responses



- B. Sc. Semester I
- B. Sc. Semester II
- B. Sc. Semester III
- B. Sc. H. Sc. Semester I
- B. Sc. H. Sc. Semester II
- B. Sc. H. Sc. Semester III

Group
75 responses



- PCB
- PBI
- PAB
- PCCM
- ECOM
- SCOM
- PSCOM
- CSZ

Batch
75 responses



- B1
- B2
- B3
- B4
- B5
- B6
- B7
- B8

Prof. Pitambar Humane
IQAC Coordinator
PROF. PITAMBAR T. HUMANE
IQAC Co-ordinator
Dharampeth M.P. Deo Memorial
Science College, Nagpur-440033

DEPARTMENT OF PHYSICS

Name & Signature of Teacher In-charge
Science College, Nagpur

Dr. Akhilesh Peshwe
Principal
PRINCIPAL
Dharampeth M. P. Deo Memorial
Science College, Nagpur.



DHARAMPETH M. P. DEO MEMORIAL SCIENCE COLLEGE, NAGPUR
INTERNAL QUALITY ASSURANCE CELL (IQAC)

Activity Report

Date: 13th October 2022

Name of Organizing Department or Committee: Microbiology Department

Name of the activity: Project Report

Suggested CRITERION point if any: Criterion II and V

Date of Activity: 13th October 2022

Place of Activity: Microbiology Laboratory

Name of Guest Speaker/s or Judge/s or Chief Guest/s if any: Guest Speaker- Nil

Title of the Activity: Project report on contribution of different scientists in enzymology

Number of Participants: 45 in 9 groups

Name of the Teacher In-charge / Convener: Dr. Vaishali Pimple

Names of other Committee Members / Staff:

OUTCOME of the Activity with respect to mission vision of the institute and or academics:

Students understood the contribution of different scientists in Enzymology, their discoveries and different models proposed by them. This activity helped the student s for deeper learning of the topics of Enzymology.

Name & Signature of Teacher In-charge

Prof. Pitambar Humane
IQAC Coordinator

Dr. Akhilesh Peshwe
Principal

COORDINATOR
INTERNAL QUALITY ASSURANCE CELL
DHARAMPETH, M. P. DEO MEMORIAL &
SCIENCE COLLEGE, NAGPUR

Principal
Dharampeth M. P. Deo Memorial
Science College, Nagpur



DHARAMPETH M. P. DEO MEMORIAL SCIENCE COLLEGE,
North Ambazari Road, Near Ambazari Lake, Nagpur- 440033

DATA VALIDATION & VERIFICATION (DWV)

Name of the Programme : NEP Activity - Project Report on Contribution of Different Scientist in Enzymology
 Date of the Programme : 22/10/2022
 Name of Chief Guest if any : Nil
 Name of Guest Speaker if any : Nil

Sr. No.	Name of the Participant	Mobile Number	E-mail Id	Signature	
1)	Ketaki R. Karpal	9112759066	ketakar12@gmail.com		Sem 3
2)	Mansi D. Raut	7385114931	Mansidraut45@gmail.com		Sem 3
3)	Mansi J. Male	8468831807	mansi1912@gmail.com		Sem 3
4)	Nikita S. Phave	9049719951	nikitaphave@378mail.com		
5)	Niket Thakre	9328895082	niketthakre92@ -		
6)	Pallavi C. Borkar	9373187246	borkarpallavi95@gmail.com		Sem III
7)	Prachal M. Mehtaram	7021735508	prachalmehtaram@gmail.com		Sem III
8)	Pooja S. Itankar	8156973252	poojaitankar95@gmail.com		Sem III
9)	Prajwal S. Bhoyar	8016434634	Prajwalb738@gmail.com		Sem III
10)	Pratiksha S. Naughtone	9623033760	Pratiksha44@gmail.com		Sem III

Signature of

Programme In-charge

IQAC Coordinator
DHARAMPETH, M. P. DEO MEMORIAL
SCIENCE COLLEGE, NAGPUR

Principal
Dharampeth M. P. Deo Memorial
Science College, Nagpur



DHARAMPETH M. P. DEO MEMORIAL SCIENCE COLLEGE,
North Ambazari Road, Near Ambazari Lake, Nagpur- 440033

DATA VALIDATION & VERIFICATION (DVV)

11	Dhanshree Y. Newalkar	9358816280	newalkardhanshree@gmail.com	D.N.
12	Diresh S. Longude	9326246453	direshlongude@gmail.com	Diresh
13	Gargi L. Hodge	7972076671	gargi/hodge@gmail.com	G.H.
14	Hansh S. Kodape	9604677672	hanshkodape008@gmail.com	H.Kodape
15	Ankur A. Raut	9167873447	ankuraaut2003@gmail.com	Ankur
16	Jyoti D. Warkar	7447366023	jyotiwarkar2000@gmail.com	Jyoti
17	Juhi S. Chaudhari	889248944	chaudharijuhit20@gmail.com	Juhi
18	Kalyani C. Shohare	939046395	shoharekalyani5@gmail.com	K.C.
19	Kaipana D. Sunegpure	9379231112	kaipanaahel@gmail.com	K.D.
20	Aanchal S. Singh	7875537925	Santoshsingh23923@gmail.com	Aanchal Singh
21	Mina B. Sheikh	8080083981	minashsheikh978@gmail.com	M.B.
22	Amitya M. Jaiswal	7391008463	amityajaiswal2009@gmail.com	A.M.
23	AMAN. A. DONARE	7703217312	amandonare2003@gmail.com	Amare
24	Anjali. A. Mishra	9395604513	anjali.mishra4954@gmail.com	Anjali
25	Aniket. V. Kulkade	7709629106	akulkade61@gmail.com	Aniket

Signature of

Programme In-charge

IQAC Coordinator

Principal
Dharampeth M.P. Deo Memorial
Science College, Nagpur



DHARAMPETH M. P. DEO MEMORIAL SCIENCE COLLEGE,
North Ambazari Road, Near Ambazari Lake, Nagpur- 440033

DATA VALIDATION & VERIFICATION (DVV)

26.	Anushree G. Chandel	9145831751	anuchandel2001@gmail.com	Anushree
27.	Chiranjyoti B. Dolai	8010135012	chiranjyotidolai22@gmail.com	B. Dolai
28.	Pareshani S. Madavi	8830146516	pareshanmadavi@gmail.com	Pareshani
29.	Rupesh C. Bhokere	8805887370	bhokere.rupesh@gmail.com	Rupesh C.
30.	Sakshi S. Mulkam	9145355733	Sakshimulkam@gmail.com	Sakshi
31.	Sagar B. Bawane	9975460979	sagarbawane37@gmail.com	S. Bawane
32.	Samir P. Ghumde	9359236723	samirpghumde2002@gmail.com	Ghumde
33.	Sania A. Raja	8775726700	midhatsania@gmail.com	Sania
34.	Sheawani Warkhede	7058368837	sheawani10@gmail.com	Sheawani
35.	Shreyas R. Deshmukh	8668282846	shreyasdeshmukh22@gmail.com	Shreyas
36.	Surbhi R. Pawdhe	7887516628	surbhipawdhe678@gmail.com	Surbhi
37.	Suresh S. Longadke	8390516517	sureshlongadke11@gmail.com	Suresh
38.	Sumit S. Bhandarkar	8788212339	sumitbhandarkar100@gmail.com	Sumit
39.	Suchanshi R. Viker	7028429177	suchanshiviker147@gmail.com	Suchanshi

Signature of:

Programme In-charge

IQAC COORDINATOR
INTERNAL QUALITY ASSURANCE CELL
DHARAMPETH, M. P. DEO MEMORIAL &
SCIENCE COLLEGE, NAGPUR

Principal
Dharampeth M. P. Deo Memorial
Science College, Nagpur

30.	Sakshi	
31.	S. Bawane	
32.	Ghumde	



DHARAMPETH M. P. DEO MEMORIAL SCIENCE COLLEGE,
North Ambazari Road, Near Ambazari Lake, Nagpur- 440033

DATA VALIDATION & VERIFICATION (DVV)

30.	Smriti M. Vaidya	8956908764	Smriti.Vaidya31@gmail.com	Smriti
31.	Shyamal D. Narsae	9765943998	shyamalnarsae@gmail.com	Shyamal
32.	Shubha S. Dhawale	8888261004	shubhadhawale14@gmail.com	Shubha
33.	Shubham C. Bisen	7448289544	shubhamobisen@gmail.com	Shubham
34.	Tejas V. Rewade	7796027056	tejasrewade888@gmail.com	Tejas
35.	Tina B. Rahangdale	9991776769	tina rahangdale@gmail.com	Tina
36.	Twinkle G. Lokhande	9149176609	twinklulokhande@gmail.com	Twinkle
37.	Urmila V. Bantre	9770675867	urbreumila2000@gmail.com	Urmila
38.	Vaibhav A. Malewar	8767838219	vaibhavamalewar23@gmail.com	Vaibhav
39.	Vaibhav A. Shinde	8020640782	Vaibhavshinde22@gmail.com	Vaibhav
40.	Vaishnavi J. Bedade	8657188093	vaishnavibedade100@gmail.com	Vaishnavi
41.	Vaishnavi R. Lakhe	8669894864	chhatulilakhe3@gmail.com	Vaishnavi
42.	Vaishnavi R. Nandpure	9322439316	Vaishnavilakhpure20@gmail.com	Vaishnavi
43.	Vaishnavi T. Kapse	8983751089	vaishnavikapse@gmail.com	Vaishnavi
44.	Vaishnavi V. Gadge	9022976449	padmavaishnavi03@gmail.com	Vaishnavi
45.	Vishakha D. Badwante	8329639834	Vishakha Badwante@gmail.com	Vishakha

Signature of:

Programme In-charge

IQAC Coordinator

Principal



DHARAMPETH M. P. DEO MEMORIAL SCIENCE COLLEGE,
North Ambazari Road, Near Ambazari Lake, Nagpur- 440033

DATA VALIDATION & VERIFICATION (DVV)

Sl. No.	Name of the Candidate	Registration No.	Grade	Remarks
1	V. Santosh B. B. 9	85321, 55796		
2				
3				
4				
5				
6				
7				
8				
9				
10				
11				
12				
13				
14				
15				
16				
17				
18				
19				
20				

Signature of:

Programme In-charge

IQAC Coordinator

Principal



Activity Report

Date: 13/10/2022

Name of Organizing Department or Committee: Department of Microbiology

Name of the activity: Poster Making and Presentation Competition

Suggested CRITERION point if any:

Date of Activity: 13/10/2022

Place of Activity: Department of Microbiology Dharampeth MP Deo Memorial Science College, Nagpur.

Name of Guest Speaker/s or Judge/s or Chief Guest/s if any: Nil

Title of the Activity: Poster making and presentation competition on paper I unit III & unit IV for semester I students.

Number of Participants: 40 students.

Name of the Teacher In-charge / Convener: Dr. Pratiksha V. Pohekar

Names of other Committee Members / Staff:

OUTCOME of the Activity with respect to mission vision of the institute and or academics:

- It helps to motivate students to learn specific topics.
- The best advantage of poster making is that it facilitates team work and understanding along with facilitating creative thinking and reading.
- It provides students with an opportunity to learn by doing, in turn strengthening the learning.
- Students are able to visually represent the key points and while presenting elaborate on the same which facilitates their retention and recall of events and facts.
- Poster making and presentation is also an effective tool for evaluating the students' knowledge and creates opportunities for active discussion and participation.



Name & Signature of Teacher In-charge

Pitambar Humane
[Handwritten Signature]

Prof. Pitambar Humane
IQAC Coordinator

Dr. Akhilesh Peshwe

Principal



DHARAMPETH M. P. DEO MEMORIAL SCIENCE COLLEGE,
North Ambazari Road, Near Ambazari Lake, Nagpur-440033

DATA VALIDATION & VERIFICATION (DVV)

Name of the Programme : Poster making and Presentation competition
Date of the Programme : 13/10/22 (Sem I)
Name of Chief Guest if any : Nil
Name of Guest Speaker if any : Nil

Sr. No.	Name of the Participant	Mobile Number	E-mail Id	Signature
1)	Chiranjiv S. Gajbhiye	8329412694	cgajbhiye@gmail	Gajbhiye
2)	Khushi K. Rewade	9588445994	khushirewade@gmail.com	Rewade
3)	Pranali Chavhare	9699654562	pranali.chavhare@gmail.com	Chavhare
4)	Aakansha Maital	8010923662	aakanshamaital@gmail.com	Aakansha
5)	Dolly Coanekar	9326013213	krishnananjati2345@gmail.com	Dolly
6)	Shruti Channekar	9699823842	shrutichannekar@gmail.com	Shruti
7)	Komalika S. Chaudhari	9322033866	KomalikaChaudhari073@gmail.com	Chaudhari
8)	Anjali R. Thakre	7066554821	Anjalithakre381@gmail.com	Anjali
9)	Sharwari Umare	9284249534	sharwariumare912@gmail.com	Sharwari
10)	Maheshwari Bhokare	9022137975	MaheshwariBhokare@gmail.com	Maheshwari

Signature of:

Programme In-charge

IQAC Coordinator

Principal
Principal

Dharampeth M. P. Deo Memorial
Science College, Nagpur



DHARAMPETH M. P. DEO MEMORIAL SCIENCE COLLEGE,
North Ambazari Road, Near Ambazari Lake, Nagpur-440033

DATA VALIDATION & VERIFICATION (DVV)

11)	Gauri Ramesh Bhoyar	8668335876	gauribhoyar34@gmail.com	Gauri
12)	Krutika Pokale	9021533341	pokalekrutika6@gmail.com	Krutika
13)	Chanchal K. Waghwan	7796016894	waghwanitara@gmail.com	Chanchal
14)	Neha L. Wanjari	9373832266	nehawangani733@gmail.com	Neha
15)	Apksha D. Katangale	7559455794	apekshakatangale26@gmail.com	Apkangale
16)	Vaishnavi N. Jange	8421657943	vaishnavi2004@gmail.com	Vange
17)	Kartikam M. Deshmukh	9699720960	Kartikam20@gmail.com	Kartikam
18)	Ritika R. Sanduiya	9175581653	ritikarsanduiya@gmail.com	Ritika
19)	Umang G. Wanthi	9322428500	umangwanthi@gmail.com	Umang
20)	Anjali Meshram	8855819748	anjali.meshram2020@gmail.com	Anjali
21)	Sonal G. Choudhari	8856055003	sonalichoudhari19@gmail.com	Sonal
22)	Anvay Barkar	9145401766	anvaybarkar19@gmail.com	Anvay
23)	Piya A. Singh	9595649881	piya52907@gmail.com	Piya
24)	Sruvika A. Jha	8982236002	Sruvika.jha@gmail.com	Sruvika
25)	Mahi. Jhaware	9960629566	thawakemahi7@gmail.com	Mahi

Signature of:

COORDINATOR
REGISTRATION & ATTENDANCE CELL
DHARAMPETH M. P. DEO MEMORIAL & SCIENCE COLLEGE, NAGPUR

Principal
Dharampeth M. P. Deo Memorial
Science College, Nagpur



DHARAMPETH M. P. DEO MEMORIAL SCIENCE COLLEGE,
North Ambazari Road, Near Ambazari Lake, Nagpur- 440033

DATA VALIDATION & VERIFICATION (DVV)

26.	Riddhi . B. Jiwari	8084143696	riddhijiwari072@gmail.com
27.	Nihu B. Rai	7088638984	snihu1412@gmail.com
28.	Muskan Kulkarni	9156889231	MuskanKulkarni34@gmail.com
29.	Yogita R. Denge	9058437240	yogitadenge@gmail.com
30.	Vaiden Thok	7558499191	VaidenThok27@gmail.com
31.	Meenal .A. Choudhary	9529014604	meenalkchoudhary2004@gmail.com
32.	Dhanashmi Newam	9359909913	dhanashminewam78@gmail.com
33.	Ashwini M. Naware	8275566422	ashwinimnaware@gmail.com
34.	Jeet S. Pardhi	7020715431	jeetpardhi111@gmail.com
35.	Pooja B. Bisen	8762549078	poojabisen@gmail.com
36.)	Ravindra m. Khadse	8007198273	khadse Ravindra 842@gmail.com
37.)	Asya Dhoke	8080851619	aryanamrata132@gmail.com
38.)	Aparna mohare	7020649887	aparna mohare@gmail.com
39.)	Anshul Kirnapure	9284067169	Anshulkirnapure@gmail.com
40.)	Priyanshu Raat	9322725283	Priyanshuraat56@gmail.com

Signature of:

[Signature]
Programme In-charge

[Signature]
IQAC Coordinator

INTERNAL QUALITY ASSURANCE CELL
DHARAMPETH M. P. DEO MEMORIAL S
SCIENCE COLLEGE, NAGPUR

Principal

Dharampeth M. P. Deo Memorial
Science College, Nagpur



Activity Report

Date: 13/10/2022

Name of Organizing Department or Committee: Department of Microbiology

Name of the activity: Class quiz competition

Suggested CRITERION point if any:

Date of Activity: 13/10/2022

Place of Activity: Department of Microbiology Dharampeth MP Deo Memorial Science College, Nagpur

Name of Guest Speaker/s or Judge/s or Chief Guest/s if any: Nil

Title of the Activity: Class quiz competition on Paper I- unit III and unit IV for semester I students.

Number of Participants: 36 students.

Name of the Teacher In-charge / Convener: Dr. Pratiksha V. Pohekar

Names of other Committee Members / Staff:

OUTCOME of the Activity with respect to mission vision of the institute and or academics:

- This syllabus based quiz competition are designed to promote, a fun way to study and in the process help improve students' knowledge.
- It helps to think from different angles or simply 'to think out of the box'.
- It promotes a healthy debate amongst students in order to learn from each other, and aiding in the team building process.
- Students can do critical thinking, and get into a habit of innovative learning.
- It helps students identify what they know and what they don't know.

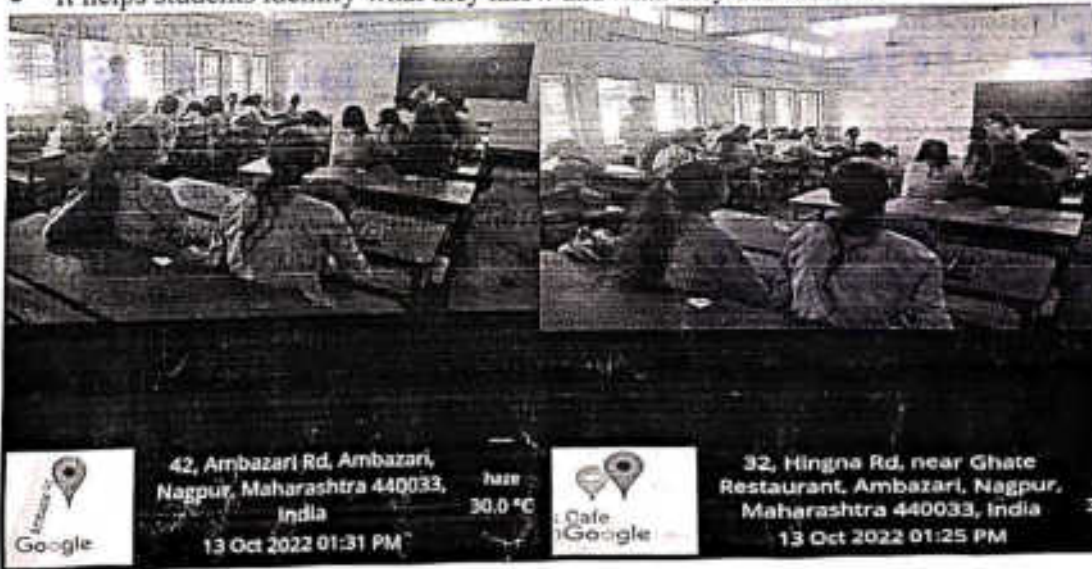

Name & Signature of Teacher In-charge

Prof. Pitambar Humane
IQAC Coordinator

Dr. Akhilesh Peshwe
Principal

Dharampeth M. P. Deo Memorial
Science College, Nagpur



DHARAMPETH M. P. DEO MEMORIAL SCIENCE COLLEGE,
North Ambazari Road, Near Ambazari Lake, Nagpur- 440033

DATA VALIDATION & VERIFICATION (DVV)

Name of the Programme : Class quiz competition

Date of the Programme : 13/10/22 (Semt)

Name of Chief Guest if any : Nil

Name of Guest Speaker if any : Nil

Sr. No.	Name of the Participant	Mobile Number	E-mail Id	Signature
1	Maheshwari Mahendra Bhokare	9022137975	maheshwariibhokare@gmail.com	
2	Vaishnavi Namdev Tonge	8421657443	vaishnavitonge2004@gmail.com	
3	Apeksha Digambar Kotangale	7559455794	apekshakotangale26@gmail.com	
4	Komalika Sheshram Chaudhari	9322033866	komalikachaudhari073@gmail.com	
5	Neha L. Wanjari	9373832266	nehawanjari783@gmail.com	
6	Riya A. Singh	9595649831	riyaas2307@gmail.com	
7	Shreyo A. Jhu	8983236002	SangretaJhu@gmail.com	
8	Ritika R. Sondwiy	9175581655	ritikasondwiy9@gmail.com	
9	Muskan Kulkarni	9156899231	MuskanKulkarni24@gmail.com	
10	Vaidehi P. Thote	7558499191	vaidehitthote27@gmail.com	

Signature of:

Programme In-charge

IQAC Coordinator

Principal

Dharampeth M. P. Deo Memorial
Science College, Nagpur



DHARAMPETH M. P. DEO MEMORIAL SCIENCE COLLEGE,
North Ambazari Road, Near Ambazari Lake, Nagpur- 440033

DATA VALIDATION & VERIFICATION (DVV)

11.	Mahi. S. Thaware	9960624566	thawaremahit7@gmail.com	Mahi
12.	Diddhi. B. Jiwari	8087143696	2iddhitiwari0720@gmail.com	Diddhi
13.	Umang. G. Wauthi	9322428500	umangwauthi@gmail.com	Umang
14.	Katika. M. Deshmukh	9699720960	katikamd20@gmail.com	Katika
15.	Aakansha. Y. Mairal	8010923662	aakanyogi2004@gmail.com	Aakansha
16.	Keya. Zade	7796546207	keyazade37@gmail.com	Keya
17.	Peyanshu. T. Raut	9322725233	peyanshucaut56@gmail.com	Peyanshu
18.	Jeet. S. Pardhi	7020215431	jeetspardhi111@gmail.com	Jeet
17.	Aparna. Mohare	7020649887	aparnamohare23@gmail.com	Aparna
20.	Nithi. B. Rai	7058638984	nithi1419@gmail.com	Nithi
21.	Pranali. Y. Chavhare	9699654562	pranali@chavhare69@gmail.com	Pranali
22.	Sharvani. L. Umare	9284249534	sharvaniumare1912@gmail.com	Sharvani
23.	Anvay. B. Borhan.	9168538614	anvayborhan.19@gmail.com	Anvay
24.	Anjali. R. Thakre	7066554821	thakreanjur381@gmail.com	Anjali
25.	Anshul. Kinnarpure	9284069169	anshulkinnarpure150@gmail.com	Anshul
26.	Yogita. R. Denge	7058437240	yogitadenge@gmail.com	Yogita

Signature of:

Programme In-charge

IQAC Coordinator

Principal

Dharampeth M. P. Deo Memorial
Science College, Nagpur



DHARAMPETH M. P. DEO MEMORIAL SCIENCE COLLEGE,
North Ambazari Road, Near Ambazari Lake, Nagpur- 440033

DATA VALIDATION & VERIFICATION (DVV)

27.	Meenal .A. Choudhary	9528014604	meenalchoudhary2004@gmail.com Meenalchoudhary
28.	Anjali .M. Singh	8317296731	anjalisingh152451@gmail.com Anjali
29.	Dhanashri Neware	9350909913	dhanashri neware 186@gmail.com Dhanashri
30.	Gauri Bhogae	8668335876	gunjanbhogae34@gmail.com Gauri
31.			
32.	Anshul .R. Yadav	9156494085	anshulyadav01521@gmail.com Anshul
33.	Ravindra Khadse	8007198273	rchadse Ravindra 842@gmail.com Ravindra
34.	Jeet S. Pardhi	7020215431	jeetspardhi11@gmail.com Jeet
35.)	Pooja B. Bisen	8767549078	poojabisen@gmail.com Pooja
36.)	Arya Dhoke	8080851619	aryanamrata132@gmail.com Arya

Signature of:

Programme In-charge

IQAC Coordinator

INTERNAL QUALITY ASSURANCE CELL
DHARAMPETH M. P. DEO MEMORIAL SCIENCE COLLEGE

Principal

Principal

Dharampeth M. P. Deo Memorial
Science College, Nagpur



DHARAMPETH M. P. DEO MEMORIAL SCIENCE COLLEGE, NAGPUR

INTERNAL QUALITY ASSURANCE CELL (IQAC)

Activity Report

Date: 14/10/2022

Name of Organizing Department or Committee: Department of Physics

Name of the activity: NEP based Demonstration Activity for B.Sc. Sem-V

Suggested CRITERION point if any: Restricted to RTMNU BSc physics syllabus.

Date of Activity: 14/10/2022

Place of Activity: Room no. 004

Name of Guest Speaker/s or Judge/s or Chief Guest/s if any: NA

Title of the Activity: Demonstration How hole is migrated through semiconductors

Activity with newspaper coverage if any: No

Number of Participants: BSc Sem-V Students - 13

Name of the Teacher In-charge / Convener: Mr. Nishant Zode

Names of other Committee Members / Staff: N.A.

OUTCOME of the Activity with respect to academics:

The students understood the phenomenon how hole is migrated through semiconductors using this activity. An electron within the valence band may fill the hole, leaving another hole in its place. In this way a hole appears to move. In the presence of an electric field electrons move in one direction and holes appear to move in the opposite direction.

DVV: Enclosed.

Activity data save in PC of: Lt. Dr. P. W. Ambekar

Prof. Pitambar Humane
IQAC Coordinator

CO ORDINATOR
INTERNAL QUALITY ASSURANCE CELL
DHARAMPETH M. P. DEO MEMORIAL &
SCIENCE COLLEGE, NAGPUR

Name & Signature of Teacher in-charge

HEAD
DEPARTMENT OF PHYSICS
Dharampeth M. P. Deo Memorial
Science College, Nagpur

Dr. Akhilesh Peshwe
Principal

Principal
Dharampeth M.P. Deo Memorial
Science College, Nagpur.



DHARAMPETH M. P. DEO MEMORIAL SCIENCE COLLEGE, NAGPUR
INTERNAL QUALITY ASSURANCE CELL (IQAC)

Activity Report

Date: 16/10/2022

Name of Organizing Department or Committee: Microbiology Department

Name of the activity: A seminar cum workshop on aptitude and reasoning

Suggested CRITERION point if any: Criterion II

Date of Activity: 15th October 2022

Place of Activity: Late shree Vinayakrao Phatak Hall

Name of Guest Speaker/s or Judge/s or Chief Guest/s if any: Guest Speaker- Mr. Sandip Bhojar and Mr Vaibhav Joshi

Title of the Activity: A seminar cum workshop on aptitude and reasoning for competitive examinations.

Number of Participants: 77

Name of the Teacher In-charge / Convener: Dr. Vidya R. Kathoke

Names of other Committee Members / Staff: Dr. Vaishali Pimple, Dr. Pratiksha Pohekar

OUTCOME of the Activity with respect to mission vision of the institute and or academics:

Such workshop helps to clarify their doubts about how to decide their aims.

They can get an idea about how to choose their future path.

The students get awareness about various job sectors they can join after graduation,

and can start preparation of competitive examinations through such workshops.



Activity with newspaper coverage any:

Prof. Pitambar Humane
IQAC Coordinator

Dr. Vidya R. Kathoke
Name & Signature of Teacher In-charge

Dr. Akhilesh Peshwe
Principal

WAR

WORKSHOP ON
ATTITUDE AND REASONING



Date:
15 Oct 2022
Saturday

Time:
2pm



**DHARAMPETH SCIENCE COLLEGE,
NAGPUR**

Microbiology Department

In Association with



Venue:

Late Shree Vinayakrao Phatak Hall

CALL: 070660 50400



Bulls Eye™

www.bullseye.ac

**Feedback Form: Microbiology Dept.
Dharampeth Science College (15th Oct,
2022)**

Workshop on Aptitude and Reasoning (WAR)

 vidyakathoke18@gmail.com (not shared) Switch account



* Required

Name *

Your answer

Your Semester: *

Semester 2

Name of the Programme : Workshop on Aptitude & Reasoning (WAR)
 Date of the Programme : 15th Oct 2022 , Time :- 2:00 pm
 Name of Chief Guest if any : Dr. Sandip Bhojare & Ms. Vaibhav Joshi
 Name of Guest Speaker if any : Ms. Sandip Bhojare

Sr. No.	Name of the Participant	Mobile Number	E-mail Id	Signature
1	Nisha vidyabhushan Panley	8605231330	Abhishek8605231330@gmail.com	<u>Nisha</u>
2	Yogita Ramesh Denge	7058437240	yogitadenge@gmail.com	<u>Yogita</u>
3	Nitu B. Rai	7058638984	nitur1419@gmail.com	<u>Nitu</u>
4	Aparna G. Mohare	7020649887	Apanamohare23@gmail	<u>Aparna</u>
5	Vamila V. Bondare	9370673867	bondarevamila.2000@gmail	<u>Vamila</u>
6	Shreyas Dhawle	8888264004	Shreyasdhawle124@gmail.com	<u>Shreyas</u>
7	Vaibhavi Shende	8080640782	Vaibhavishende97@gmail.com	<u>V.A. Shende</u>
8	Siddhant Hirkane	9579092931	SiddhantHirkane@gmail.com	<u>Siddhant</u>
9	Avanti chaphekar	7875173847	avanti1011@gmail.com	<u>Avanti</u>
10	Asha A. Sakharwarde	9405197842	ashasakharwarde@gmail.com	<u>Ashakharwarde</u>

nature of:

Kalshoke
 Programme In-charge

IQAC Coordinator

Principal
 Shree Principal
 Science College



DATA VALIDATION & VERIFICATION (DVV) 2nd year

11	Poojalu b. Dandale	9325473318	dancehonyali6@gmail.com	<u>P. Dandale</u>
12	Vaibhavi A. Malewar	8767838219	vaibhavamalewar0794@gmail.com	<u>V. Malewar</u>
13	Nikita S. Bhawe	9860159628	nikitabhawe@gmail.com	<u>N. Bhawe</u>
14	Swati S. Longadga	8290516517	swatiklongadga@gmail.com	<u>Swati</u>
15	Vishnavi T. Kapse	8983751089	vishnavikapse05@gmail.com	<u>V. Kapse</u>
16	Sagar S. Bawane	9975460979	sagorbawane@gmail.com	<u>S. Bawane</u>
17	Chirayu B. Dolas	8010185012	chirayudolas22@gmail.com	<u>C. Dolas</u>
18	Vishnavi V. Gadga	9022976449	gadgavishnavi02@gmail.com	<u>V. Gadga</u>
19	Harsh S. Kodape	9604677672	harshkodape008@gmail.com	<u>H. Kodape</u>
20	Pesha C. Bholave	8805887370	bholavapesha@gmail.com	<u>P. Bholave</u>
21	Smeera P. Ghumde	9355236713	smeerghumde02@gmail.com	<u>S. Ghumde</u>
22	Pooja S. Itankar	9156973252	poojaitankar987@gmail.com	<u>P. Itankar</u>
23	Twinkal G. Lokhande	8149176609	twinkalokhande14@gmail.com	<u>T. Lokhande</u>
24	Anjali A. Mishra	9320604513	anjalinimishra4954@gmail.com	<u>A. Mishra</u>
25	Shrawani R. Warkhede	8806636133	shrawanivarthede1@gmail.com	<u>S. Warkhede</u>

Signature of

Warkhede
Programme In-charge

Principal
Dharampeth M. P. Deo Memorial
Science College, Nagpur



DHARAMPETH M. P. DEO MEMORIAL SCIENCE COLLEGE,
North Ambazari Road, Near Ambazari Lake, Nagpur- 440033

DATA VALIDATION & VERIFICATION (DVV)

26	Niket .Y. Thakre	7378899087	niketthakre82@gmail.com	niket
27	Vishnavi.R.Nandpure	9322439316	vaishnavinandpure6@gmail.com	Vish
28	Vaishnavi . R. Lakhe	8669594864	chhakuji.lakhe56@gmail.com	Vaish
29	Chhakuji .G. Wadikar	9325049907	chhaku.wadikar@gmail.com	Chhaku
30	Tina .G. Rahangdale	9921776769	tina.rahangdale@gmail.com	Tina
31	Juhi S. Chaudhari	8669248944	chaudharijuhi12@gmail.com	Juhi
32	Sakshi Meshram	9145355733	sakshimeshram21@gmail.com	Sakshi
33	Jagruti Wadkar	7447366023	jagrutiwadkar09@gmail.com	Jagruti
34	Mansi Mate	84891807	mansi1972@gmail.com	Mansi
35	Anushree Chandel	9145631751	anushreechandel2001@gmail.com	Anushree
36	Afina Sheikh	8080083981	afinashikh973@gmail.com	Afina
37	Gauri Raut	9767873447	ankuraut2003@gmail.com	Gauri
38	Ketaki Kirpal	9112759066	ketakikirpal13@gmail.com	Ketaki
39	Pragya Bhoyare	8010494634	Pragya16138@gmail.com	Pragya
40	Komalika S. Chaudhari	9322093866	Komalika.choudhari073@gmail.com	Komalika

Signature of

Katke
Program In-charge

HAC Coordinator

Principal
Dharampeth M. P. Deo Memorial
Principal



DATA VALIDATION & VERIFICATION (DVV)

41	Shatwati - L. Umare	9284249534	sharwariumare1912@gmail.com	<i>[Signature]</i>
42	Anvay - R. Borkar	9145401246	AnvayBorkar420@gmail.com	<i>[Signature]</i>
43	Teet S Pardhi	7020215431	jeetpandhi111@gmail.com	<i>[Signature]</i>
44	Chirajiv Gajbiye	1796403357	cgajbiye17@gmail.com	<i>[Signature]</i>
45	Khushi Rewade	9588445994	khushirewade@gmail.com	<i>[Signature]</i>
46	Jasraj Paliwal	9320820325	jasrajpaliwal@gmail.com	<i>[Signature]</i>
47	Anshul Yashraj Kinapure	9284067169	anshulkinapure650@gmail.com	<i>[Signature]</i>
48	Apeksha - D. Kotangale	7559455794	apekshaketangale26@gmail.com	<i>[Signature]</i>
49	Vaishnavi N. Tonge	8421657943	vaishnavitonge2004@gmail.com	<i>[Signature]</i>
50	Arya Dhoke	8080851619		<i>[Signature]</i>
51	Ravindra Khadse	8007198273	khadse.ravindra892@gmail.com	<i>[Signature]</i>
52	Maheshwari M Bhokare	9022137975	maheshwaribhokare@gmail.com	<i>[Signature]</i>
53	Aishwarya A. Joshi	7498328662	aishwaryajoshi2005@gmail.com	<i>[Signature]</i>
54	Bhargavi A. Sambare	9709403806	bhargavisambare05@gmail.com	<i>[Signature]</i>
55	Nandini S. Hodge	9370301579	nandihodge17@gmail.com	<i>[Signature]</i>

Signature of:

[Signature]
Programme In-charge

IQAC Coordinator



DATA VALIDATION & VERIFICATION (DVV)

56	Ishita S. Thakre	CZM	8010907069	
57	Laxmi Jogle	CZM	7758058514	
58	Shruti Pawar	CZM	9527988707	
59	Tanmay Choudhari	CZM	8600102341	
60	Manish S. Grade	CZM	9370329857	
61	Bhumnika D. Chedge	CBM	8830391103	
62	Sanyukta Choudhari	CBM	7517090406	
63	Ayushi Shukla	CBM	9373668043	
64	Sayali Lokhande	CBM	9356413804	
65	Roshani Bambal	CBM	9325853408	
66	Vivek R. Waghmare	CBM	8956482591	
67	Krushnali S. Kadu	CBM	8625854995	
68	Madhura Blendure	CBM	8767484914	
69	Rinam C. Wankhede	CBM	8010966529	
70	Rupesh W. Wankhede	CBM	8329676611	

Signature of:

Program In-charge

IQAC Coordinator

Principal



Activity Report

Date: 30.10.22

Name of Organizing Department or Committee: Department of Home-Science

Name of the activity: Visit to Aroha center

Suggested CRITERION point if any: II

Date of Activity: 15.10.22

Place of Activity: Aroha center ,Wadi

Name of Guest Speaker/s or Judge/s or Chief Guest/s if any: Nil

Title of the Activity: Visit to Aroha Centre

Number of Participants: 14

Name of the Teacher In-charge / Convener: Pradnya Bagalkote ,Dr Manda Walokar

Names of other Committee Members / Staff: Rekha Tai, __Attendant ,Home Science

OUTCOME of the Activity with respect to mission vision of the institute and or academics:

Educational Talk for awareness purpose to teachers, students & Mahila of nearby Community

Study of Anthropometric Assessment, taking heights & Weights of children of school

Nutrition Education & Awareness of eating right.

Students learnt about how to conduct Survey Demonstration of healthy easy & quick snacks for school Children.

Activity with newspaper coverage if any: Yes, It is the local newspaper titled "sakar "

Activity data save in PC of: Mrs M M Deshpande

Note: Kindly share geotag photographs separately along with report on iqacdsc2022@gmail.com



Small text block, possibly a newspaper clipping or report snippet, partially legible.

[Handwritten Signature]

Prof. Pitambar Humane
COORDINATOR
INTERNAL QUALITY ASSURANCE CELL
DHARAMPETH M. P. DEO MEMORIAL &
SCIENCE COLLEGE, NAGPUR

[Handwritten Signature]

Name & Signature of Teacher In-charge

[Handwritten Signature]

Dr. Akhilesh Peshwe
PRINCIPAL
Dharampeth M. P. Deo Memorial
Science Principal nagpur-440032

On the occasion of World Food Day.

Dharampeth M P Deo Memorial Science College in collibration with Aaroh Prashikhan Kendra organises a Health Check up camp for Aroha Centre Wadi.

Date 15 th October 2022 at 2pm

Venue:- Aroha Centre,Back side of Bharat Petrolium, Wadi Nagpur.

- 1.Talk on Nutrition and Fitness by Mrs Pardnya Bagalkote.
- 2.Anthropmetric Assessment and BP check up with Home Students.
- 3.Work for Social cause in Rural Area by Dr Manda Walokar Madam.
- 4.Google form survey of Mahal and Wadi employees of Aroha.
5. Demonstration of Healthy Recipes.

Head Department of Home Science
Dharampeth M.P. Deo Memorial
Science College, Nagpur

Visit to Axoha Center (Wadi)
Date: 15/10/22



DHARAMPETH M. P. DEO MEMORIAL SCIENCE COLLEGE,
North Ambazari Road, Near Ambazari Lake, Nagpur- 440033

DATA VALIDATION & VERIFICATION (DVV)

1.	Tannu S. Korde	kordetannu138@gmail.com	7841984450	T. Korde
2.	Avani S. Shenwai	Avanishenwais@gmail.com	9096507459	A. Shenwai
3.	Gjauji M. Wankhede	WankhedeGjauji@gmail.com	87676969751	G. Wankhede
4.	Pallavi B. Katre	Pkatre573@gmail.com	8459277408	P. Katre
5.	Bhagyashree S. Ambule	ambuleb667@gmail.com	9359139068	B. Ambule
6.	Bhushali G. Chormare	bhushalichormare@gmail.com	7057791359	B. Chormare
7.	Nisha A. Chormare	nishachormare5@gmail.com	8669586501	N. Chormare
8.	Punell H. Chhangadkar	Pcham402gh@gmail.com	9309079427	P. Chhangadkar
9.	Prachi N. Lokkar	Prachilokkar159@gmail.com	8806244419	P. Lokkar
10.	Deepika R. Yawar	clys7g608@oxygen.com	919097416245	D. Yawar
11.	Vaishnavi K. Pradhan	pradhanvaishnavi05@gmail.com	9763169580	V. Pradhan
12.	Sujata V. Kaurte	SujataKaurte1@gmail.com	9175451202	S. Kaurte
13.	Kesini T. Diwe	Kesinidive1@gmail.com	9655788313	K. Diwe
14.	Priya K. Khawshi	Priyakhawshi3@gmail.com	9763617229	P. Khawshi

Signature of:

Programme In-charge

COORDINATOR
INTERNAL QUALITY ASSURANCE CELL
DHARAMPETH, M. P. DEO MEMORIAL
SCIENCE COLLEGE

DHARAMPETH M. P. DEO MEMORIAL
SCIENCE COLLEGE, NAGPUR-440033



Dharampeth M.P. Deo Memorial science College, Nagpur

Academic Session: 2022-2023

Department of Microbiology

NOTICE

All the students of BSc Semester I, III, V are hereby informed that their respective NEP activities and topics are scheduled as below. All the students are expected to participate in their respective activities on mentioned dates.

Class	Name of Activity	Date of Activity
BSc Semester I	Poster making on Microscopy & Staining Techniques	24/8/2022
BSc Semester III	Poster making on Classification of Amino acids & Structure of Hemoglobin	17/11/2022
BSc Semester III	Project making on Contribution of Different Scientists in Enzymology	13/10/2022
Bsc Semester V	Project Report on applications of electrophoresis & Chromatography in Diagnostics	15/11/2022
BSc Semester V	Crossword puzzle on Chromatography	22/11/2022

Pimple

Signature of Teacher In charge

Kathoke
Signature & Stamp of HOD
Dr. V. R. Kathoke
Head
Dept. of Microbiology
Dharampeth M.P. Deo Memorial
Science College, Nagpur



DHARAMPETH M. P. DEO MEMORIAL SCIENCE COLLEGE,
North Ambazari Road, Near Ambazari Lake, Nagpur- 440033

DATA VALIDATION & VERIFICATION (DVV)

Name of the Programme : NEP ACTIVITY - Charts on
Date of the Programme : 15/17/10/2022
Name of Chief Guest if any : Nil
Name of Guest Speaker if any : Nil

Sr. No.	Name of the Participant	Mobile Number	E-mail Id	Signature	
1	Vaishnavi . V. Gadge	9027976449	gadgervaishnavi@gmail.com		SEM 3
2	Vedant . Bomy	8530455796	vedantbomy2003@gmail.com		SEM 3
3	Gaangi Hadge	7972076671	gaangihadge@gmail.com		SEM 3
4	Harsh Kodape	9604677672	harshkodape007@gmail.com		SEM 3
5	Pranjal Bhojare	8010434634	pranjal1872@gmail.com		SEM 3
6	Meenal . A. Chaudhary	9529014604	meenalchaudhary2004@gmail.com		SEM 2
7	Chanchal . K. Waghmare	7796016894	waghmarechanchal@gmail.com		Sem I
8	Ketaki R. Karpal	9112759066	ketakikarpal11@gmail.com		Sem III
9	Mansi D. Raut	7383114931	mansidaut05@gmail.com		Sem III
10	Mans. I. Male	8468891807	mansi1918@gmail.com		sem III.

Signature of:

Programme In-charge

IQAC Coordinator

INTERNAL QUALITY ASSURANCE CELL
DHARAMPETH, M. P. DEO MEMORIAL &
SCIENCE COLLEGE, NAGPUR

Principal

Dharampeth M. P. Deo Memorial
Science College, Nagpur.



DHARAMPETH M. P. DEO MEMORIAL SCIENCE COLLEGE,
North Ambazari Road, Near Ambazari Lake, Nagpur- 440033

DATA VALIDATION & VERIFICATION (DVV)

11	Niket Y. Thakre	7378899087	niketthakre31@a	NThakre	Sem III
12	Pullover C. Borke	9373187246	haskarpullover193@gmail.com	P	Sem III
13	Pooja .S. Tankar	9156973252	poojaitankar31@gmail.com	P	Sem III
14	Pranjwal .S. Bhojwar	806434634	Pranjwalb738@gmail.com	P	Sem III
20	Pratiksha S. Manghate	8623033760	Pratiksha94@gmail.com	P.S. Manghate	Sem III
21	Prachal m. Meshram	7028735508	Prachalmeshram@gmail.com	Prachal M	Sem - III
22	Devesh S. Longadje	3326246453	deveshlongadje@gmail.com	Devsh	Sem - III
23	Gargi L. Madge	7972076671	gargimadje@gmail.com	Gargi	Sem - III
24	Dhanshree Y. Newalkar	9356516280	newalkardhanshree@gmail.com	D.H.S.	Sem III
25	Chauhan .A .Raut	9167873447	chauhana2003@gmail.com	Chauhan	Sem III
26	Jagruiti D. Wankar	7447366023	jagruitiwankar@gmail.com	Jagruiti	Sem III
27	Juhi S. Chaudhari	8669248944	chaudharijuhi20@gmail.com	Juhi	Sem III
28	Jyoti .J. Sharma	8669736880	jjyotis890@gmail.com	J. Sharma	Sem III
29	Karpana D. Sathgopure	9579236712	karpanasathgopure@gmail.com	Karpana	Sem III
30	Kalyani C. Shahare	9309046378	shaharekalyani5@gmail.com	K.S.	Sem III
31	Aditya M. Tiwari	7391008463	mittileshbharadwaj@gmail.com	A.M. Tiwari	Sem III

Signature of:

Pimple

Programme In-charge

[Signature]

IQAC Coordinator

CO-ORDINATOR
INTERNAL QUALITY ASSURANCE CELL
DHARAMPETH, M. P. DEO MEMORIAL &
SCIENCE COLLEGE, NAGPUR

Principal
Dharampeth M.P. Deo Memorial
Science College, Nagpur
Principal



DHARAMPETH M. P. DEO MEMORIAL SCIENCE COLLEGE,
North Ambazari Road, Near Ambazari Lake, Nagpur- 440033

DATA VALIDATION & VERIFICATION (DVV)

32.	Aanchal S. Singh	7875537925	SandoshSingh23328@gmail.com	Aanchal Singh
33.	Afsina R. Sheikh	8080083981	afsinasheikh973@gmail.com	Sheikh
34.	Aniket V. Kulkarni	7709629106	akulkarni61@gmail.com	Aniket
35.	Anushree chandel	9145631751	Anushreechandel2001@gmail.com	Anushree
36.	Anjali A. Mishra	9325804513	anjali.mishra.4956@gmail.com	Anjali
37.	Chhakuli G. Wadikar	9325047907	chhakuwadikar@gmail.com	Wadikar
38.	Drishana S. Madavi	8830146516	Drishnamadavi@gmail.com	Madavi
40.	Rupesh C. Bhokre	8865887340	bhokrerupesh@gmail.com	Bhokre
41.	Sagar S. Bawane	9975460979	sagarbawane637@gmail.com	Sagar
42.	Samir P. Ghumde	9259226723	Samirghumde2002@gmail.com	Ghumde
43.	Sania A. Raja	8975726700	richhasania@gmail.com	Raja
44.	Sakshi S. Meshram	9145355733	sakshimeshram@gmail.com	Sakshi
45.	Shital G. Bankar	7758055139	Shitalbankar122@gmail.com	Shital Bankar
46.	Shreyas P. Deshmukh	8668282846	Shreyasdeshmukh2002@gmail.com	Shreyas

Signature of:

Programme in-charge

IQAC Coordinator

Principal



DHARAMPETH M. P. DEO MEMORIAL SCIENCE COLLEGE,
North Ambazari Road, Near Ambazari Lake, Nagpur- 440033

DATA VALIDATION & VERIFICATION (DVV)

47	Suruti S. Lonqarje	8390576517	SurutiLonqarje116@gmail.com	Suruti
48	Sumit S. Bandedhche	8788212339	Sumitbandekhche@gmail.com	Sumit
49	Surabhi R. Pawarthe	7887526628	Surabhipawarthe67@gmail.com	Surabhi
50	Smriti M. Vaidya	9756909764	SmritiVaidya16@gmail.com	Smriti
51	Shyamal D. Nasse	9765943998	shyamalnasse@gmail.com	Shyamal
52	Shubham C. Bisen	7448289544	Shubhamcbsen@gmail.com	Shubham
53	Shreyas S. Dhawale	8888264004	shreyasdhawale123@gmail.com	Shreyas
54	Tejas V. Rewade	7796027056	tejasrewade83@gmail.com	Tejas
55	Twinkal B. Lakhonde	9149176009	twinkalbhonde16@gmail.com	Twinkal
56	Tinora B. Rahungdale	9921776769	tinorarahungdale@gmail.com	Tinora
57	Urmila V. Bhande	9390615867	urmilavbhande@gmail.com	Urmila
58	Vaibhav A. Malewar	8767838219	vaibhavamalewar@gmail.com	Vaibhav
59	Vaibhavi A. Bhande	8080640782	vaibhavibhande97@gmail.com	Vaibhavi
60	Vaishnav J. Bedade	8657188093	vaishnavbedade10@gmail.com	Vaishnav
61	Vaishnavi R. Lakhe	8669591564	chhatruti.lakhe@gmail.com	Vaishnavi
62	Vaishnav R. Nandhure	9322435816	VaishnavNandhure@gmail.com	Vaishnav

Signature of:

[Signature]

Programme In-charge

Signature

[Signature]

CO ORDINATOR
INTERNAL QUALITY ASSURANCE CELL
DHARAMPETH, M. P. DEO MEMORIAL &
SCIENCE COLLEGE, NAGPUR

Principal

DHARAMPETH, M. P. DEO MEMORIAL &
SCIENCE COLLEGE, NAGPUR



DHARAMPETH M. P. DEO MEMORIAL SCIENCE COLLEGE, NAGPUR
INTERNAL QUALITY ASSURANCE CELL (IQAC)

Activity Report NEP

Date: 30/10/2022

Name of Organizing Department or Committee: Home science Department

Name of the activity: Essay writing on Therapeutic Diets.

Suggested CRITERION point if any:

Date of Activity: 15/10/2022

Place of Activity: Home Science Department

Name of Guest Speaker/s or Judge/s or Chief Guest/s if any:

Title of the Activity: Essay writing on Therapeutic Diets.

Number of Participants: 11

Name of the Teacher In-charge / Convener: Mrs Pradnya M Bagalkote

Names of other Committee Members / Staff: HOD Manju Deshpande ma'am

OUTCOME of the Activity with respect to the mission vision of the institute and or academics: It will help to enhance their writing skills and to understand the concept of Therapeutic Diets.

Activity with newspaper coverage if any:

Activity data save in PC of:

Note: Kindly share geotag photographs separately along with report on igacdsc2022@gmail.com

Prof. Pitambar Humane
IQAC Coordinator
CO ORDINATOR
INTERNAL QUALITY ASSURANCE CELL
DHARAMPETH, M. P. DEO MEMORIAL &
SCIENCE COLLEGE, NAGPUR

RB
Name & Signature of Teacher In-charge
Mrs Pradnya M. Bagalkote
Science College, Nagpur

Dr. Akhilesh Peshwe
PRINCIPAL
DHARAMPETH M. P. DEO
MEMORIAL SCIENCE COLLEGE
NAGPUR



DHARAMPETH M. P. DEO MEMORIAL SCIENCE COLLEGE,
North Ambazari Road, Near Ambazari Lake, Nagpur- 440033

DATA VALIDATION & VERIFICATION (DVV)

15/8/2022

Essay Competition
NEP -
Therapeutic Diets
Sem V

Sr.No.	Name	Mobile No.	Mail ID.	Sign
1	Mahima Wankhede	7821883251	mahimawankhede@gmail.com	Mahima
2	Vaishnavi Bahadure	9284679244	vaishnavibahadure3@gmail.com	Vaishnavi
3	Ananya A. Meghree	9284834439	ananyameghree@gmail.com	Ananya
4	Meghumi G. Mali	7498065023	Ashpa Mali 1947@gmail.com	Meghumi
5	Sushmita Mallick	7609337916560	sushmm760@gmail.com	Sushmita
6	Aarti Raut	8625813184	aarti.raut@gmail.com	Aarti
7	Sakshi Thorax	8177911360	Sakshithorax620@gmail.com	Sakshi
8	Aashi Ramteke	8983345716	aashiramteke7@gmail.com	Ramteke
9	Riya Sherkar	7249070278	sherkar04riya@gmail.com	Rihas
10	Vanshika Todase	9511744575	vanshika.todase@gmail.com	vanshika
11	Puja Chute	9552381381	pujachute23@gmail.com	Puja
12				
13				
14				

Signature of:

Program In-charge

IQAC Coordinator
CO ORDINATOR
INTERNAL QUALITY ASSURANCE CELL
DHARAMPETH, M. P. DEO MEMORIAL
SCIENCE COLLEGE, NAGPUR

Principal
Dharampeth M. P. Deo Memorial
Science College, Nagpur



DHARAMPETH M. P. DEO MEMORIAL SCIENCE COLLEGE, NAGPUR

INTERNAL QUALITY ASSURANCE CELL (IQAC)

Activity Report

Date: 15th October 2022

Name of Organizing Department or Committee: Electronics Department
Name of the Activity : Solving, minimizing and verifying Boolean Equations using Boolean Laws
Suggested CRITERION point if any: Suggested criteria II
Date of Activity: 15th October 2022
Place of Activity : Electronics Lab

Name of Guest Speaker/s or Judge/s or Chief Guest/s if any : Not applicable

Title of the Activity: Solving, minimizing and verifying Boolean Equations using Boolean Laws
Based on Unit : 2(Paper 2)
Class : Semester I
Number of Participants: 17

Name of the Teacher In-charge / Convener: Prof. V. V. Rangari

OUTCOME of the Activity with respect to mission vision of the institute and or academics:

Students are aware of the use of Boolean laws for the simplifications of Boolean equations.

Prof. V. V. Rangari

Head of the Department

Prof. Pitambar Humane

IQAC Coordinator

CO ORDINATOR

INTERNAL QUALITY ASSURANCE CELL
DHARAMPETH, M. P. DEO MEMORIAL &
SCIENCE COLLEGE, NAGPUR

Dr. Akhilesh Peshwe

Principal

Dharampeth M.P. Deo Memorial
Science College, Nagpur.



DHARAMPETH M. P. DEO MEMORIAL SCIENCE COLLEGE, NAGPUR

Department of Electronics

Semester I- (2022-23)

Activity (Paper II - Unit- 2)

Sr. No.	Student Name	Mobile Number	Email ID
1	Sandeep Rakesh Kumar Kumar	8081144948	sandeepk27900@gmail.com
2	Tushal Rupkumar Achare	9075995617	acharetushal5@gmail.com
3	Vedant Onkar Umretkar	9049932753	umretkarvedant@gmail.com
4	Ved Sudhir Choudhary	7498572766	vedchoudhary.cs.749@gmail.com
5	Abhishek Ravindra Singh	8208948107	abhi0882005@gmail.com
6	Khushbu Rajiv Pali	8459565214	palikhushbu59@gmail.com
7	Khushi Rajiv Pali	8767607224	palikhushi4@gmail.com
8	Harshata Gunderao Warkhede	9860432428	bandukeshao20@gmail.com
9	Vaidhavi Baburao Gongal	7507907278	gayatrigongal787@gmail.com
10	Simran Narendra Dhimole	8390347026	mishralaxmi210@gmail.com
11	Tanu Ajay Singh	8806355808	tanusingh63492@gmail.com
12	Tejas Rajesh Chelmelwar	9604662119	tejaschelmelwar@gmail.com
13	Aayushi Vikram Singh	9595119942	senxerox04@gmail.com
14	Aniket Jayram Bawankar	9322804484	adityabawankar9@gmail.com
15	Isha Ishwar Waghmare	8855919474	ishawaghmare9474@gmail.com
16	Bhagyashali Dadarao Neware	7796434177	sakshineware2017@gmail.com
17	Uday Chandrashekhar Baghele	8459549609	bagheleuday@gmail.com

Name & Signature of Teacher In-Charge

Prof. Pitambar Humane
IQAC Coordinator

CO ORDINATOR

INTERNAL QUALITY ASSURANCE CELL
DHARAMPETH, M. P. DEO MEMORIAL &
SCIENCE COLLEGE, NAGPUR

Name & Signature of Head of the Department

Dr. Varsha V. R.
Professor & Head
Department of Elec
Dharampeth M.P. Deo M
Science College, Nagpur

Dr. Akhilesh Peshwe
Principal
Principal
Dharampeth M.P. Deo Memorial
Science College, Nagpur.



DHARAMPETH M. P. DEO MEMORIAL SCIENCE COLLEGE, NAGPUR
INTERNAL QUALITY ASSURANCE CELL (IQAC)

Activity Report

Date: 30th Aug., 2022

Name of Organizing Department or Committee: NATIONAL SERVICE SCHEME (NSS)

Name of the activity: Vaccination Drive

Suggested CRITERION point if any: CRITERION-III

Date of Activity: 17th August, 2022

Place of Activity: Ambazari and Yashwant Nagar premises

Name of Guest Speaker/s or Judge/s or Chief Guest/s if any: NA

Title of the Activity: Vaccination Drive for Covid-19 & Tetanus diphtheria in association with Nagpur Municipal Corporation

Number of Participants: 45

Name of the Teacher In-charge / Convener: Prof. Pitambar Humane

Names of other Committee Members / Staff: Dr. Nitin Gaikwad, Prof. Mrs. Varsha Rangari, Dr. Mrs. Shraddha Deshpande, Dr. Mrs. Kirti Paturkar, Mrs. Ruma Kapre

OUTCOME of the Activity with respect to mission vision of the institute and or academics:

To provide free vaccination to the students and staff of the college a vaccination drive was organized. In this vaccination drive the vaccines for Covid-19 and Tetanus diphtheria was made available for the students and staff. Many teaching and non-teaching staff members as well as students benefitted by this activity. More than five members from Nagpur Municipal Corporation were present during the drive to provide this facility.

Activity with newspaper coverage if any:

Activity data save in PC of: Prof. Pitambar Humane's Laptop



Prof. Pitambar Humane
IQAC Coordinator

CO ORDINATOR
INTERNAL QUALITY ASSURANCE CELL
DHARAMPETH, M. P. DEO MEMORIAL &
SCIENCE COLLEGE, NAGPUR

Name & Signature of Teacher In-charge

Dr. Akhilesh Peshwe
Principal **Principal**
Dharampeth M.P. Deo Memorial
Science College, Nagpur.



DHARAMPETH M. P. DEO MEMORIAL SCIENCE COLLEGE, NAGPUR

NATIONAL SERVICE SCHEME (NSS)

Vaccination Drive in Association with NMC

17th Aug., 2022

Sr. No.	Name of the Student	email id	Mobile Number
1	MUSKAN RAMESHWAR YADAV	muskanyadav1225@gmail.com	9579492617
2	UDAY CHANDRASHEKHAR BAGHELE	bagheleuday@gmail.com	8459549609
3	DURGESH KISHOR GHODMARE	durgeshghodmare0011@gmail.com	9075318618
4	SAKSHI VITTHAL CHAMATE	chamatesakshi24@gamil.com	7709204933
5	VANSHIKA CHHOTELA YEDE	vanshikayede1@gmail.com	7558244609
6	RUSHIKESH BHAURAO HAMBARDE	rushikeshhambarde9786@gmail.com	9028225874
7	AAKANSHA KAMAL KHOBRAGADE	aakanshakhobragade7@gmail.com	7972228707
8	SALONI DYANESHWAR DONGRE	dongresaloni0@gmail.com	99233 61488
9	MUKESH JAWARA ORAON	oraonm64@gmail.com	7249339368
10	NEHA ARVIND WAGHADE	nehawaghade16082002@gmail.com	7249895144
11	PRACHAL MANIK MESHRAM	prachalmeshram47@gmail.com	7028735508
12	VEENA ULHAS BORIKAR	veenaborikar14@gmail.com	9322016921
13	SAURABH PRATAP SHARMA	saurabhsharma1069@gmail.com	9130964601
14	VARSHA LEKHRAM TURKAR	varshaturkar488@gmail.com	9373650950
15	RUTIKA GORAKH YADAV	yadavrutika434@gmail.com	8446085943
16	SANIYA PRAVEEN NAIK	saniyanaik51@gmail.com	9370570457
17	OM SURESH DHURVE	omdhurve277@gmail.com	8767016318
18	SRUSHTI MADAN GAIKWAD	srushtigaikwad86935@gmail.com	7385532705
19	VAISHNAVI RAMKRUSHNA CHANDEKAR	vaishnavichandekar000@gmail.com	7249882964
20	RAKHI PRABHAKAR GEDAM	gedamrakhi2000@gmail.com	7378312504
21	RANI BHIWAJI KATWALE	bkrani8112@gmail.com	9011247038
22	SAKSHI PRAVIN MANKAR	sakshi2018mmm@gmail.com	8180816539
23	PRANALI RATNAKAR DEHANKAR	pdehna@gmail.com	8767581278
24	NEHA JAGDISH BANKAR	neha2002bankar@gmail.com	8055477553
25	PRANAY SUNIL DHORE	dhorepranay532@gmail.com	8830629245
26	SIMRAN NARENDRA DHIMOLE	mishralaxmi210@gmail.com	9284583851
27	ANJALI RAJENDRA THAKRE	thakreanju381@gmail.com	7066554821
28	AMAN SUJIT KARN	karn7817@gmail.com	9028837552
29	VAIBHAV ARUN MALEWAR	vaibhavmalewar94@gmail.com	8767838219
30	MAHIMA SUNIL KHARE	mahimakhare11@gmail.com	9545918678
31	RENUKA VISHAL LANDE	renukalande220@gmail.com	7719951401
32	TUSHAL RUPKUMAR ACHARE	acharetushal5@gmail.com	9075995617
33	SAGER SHRIKANT BAWANE	sagerbawane637@gmail.com	9975460979
34	ANJALI NAMDEV CHARDE	anjalicharde20@gmail.com	8261964188

Sr. No.	Name of the Student	email id	Mobile Number
35	TANUSHREE RAJENDRA DATE	tanushreedate22@gmail.com	9766927406
36	CHIRAYU BHAGWANT DOLAS	chirayudolas22@gmail.com	8010135012
37	PRANAY SANTOSH MAHAJAN	pranaymahajan413@gmail.com	7385551492
38	Mukund Sanjay Hood	mukundhood2003@gmail.com	9604785822
39	MAHESH PRABHAKAR MASKE	maheshmaske48@gmail.com	9021951173
40	RAJAT LAXMAN ROHAD	rajatrohad413@gmail.com	9175635273
41	SHIVAM UMESH PATEL	sp040263@gmail.com	7038889083
42	KARTIK NARENDRA MIRE	kartikmire2004@gmail.com	9604792402
43	KALYANI CHUDAMAN SHAHARE	shaharekalyani5@gmail.com	9307046378
44	PRANAY ARUN CHOUDHARI	chaudharypranay45@gmail.com	7822804584
45	ISHIKA SANJAY THAKRE	ishithakre22@gmail.com	8010907069



Prof. Pitambar Humane

Program Officer, NSS



DHARAMPETH M. P. DEO MEMORIAL SCIENCE COLLEGE, NAGPUR
INTERNAL QUALITY ASSURANCE CELL (IQAC)

Activity Report

Date: 30/10/2022

Name of Organizing Department or Committee: Computer Science

Name of the activity: Quiz Competition

Suggested CRITERION point if any: V

Date of Activity: 17/10/2022

Place of Activity: Room Number 10, Computer Science Laboratory

Name of Guest Speaker/s or Judge/s or Chief Guest/s if any: NA

Title of the Activity: Quiz Competition "Mind Fest 2022"

Number of Participants: 41

Name of the Teacher In-charge / Convener: Mrs. Ruma Kapre

Names of other Committee Members / Staff: Mrs. Shraddha Ozarkar

OUTCOME of the Activity with respect to mission vision of the institute and or academics:

Department organized Quiz Competition for the computer science students. In all 41 students participated in written test which was the first round for the competition. From the written test 12 students 3 from each semester was selected on the basis of their scores in the written test. 4 groups were formed, each group consisting of students from Sem. I, III and V. these groups then played 4 rounds namely Rapid Fire, Logo Recognition, identify Computer Science Scientist and General Knowledge. On the basis of these rounds following team were selected as the winning and runner up teams.

Winner Team: Ms. Neha Jagdish Bankar Sem. V

Ms. Renuka Vishal Lande Sem. III

Mohit Maroti Khirdekar Sem. I

Runner Up Team: Ms. Tanu Sanjay Mohurle Sem. V

Sumit Vijay Sable Sem. III

Ms. Veena Ulhas Borikar Sem. I

All the 12 students got certificate of winner or participation.

Activity with newspaper coverage if any: NA

Activity data save in PC of: Mrs. Ruma Kapre



Prof. Pitambar Humane
IQAC Coordinator

CO ORDINATOR

INTERNAL QUALITY ASSURANCE CELL,
DHARAMPETH, M. P. DEO MEMORIAL &
SCIENCE COLLEGE, NAGPUR

Mrs. Ruma Kapre
Name & Signature of Teacher In-charge

Dr. Akhilesh Peshwe
Principal

Principal

Dharampeth M.P. Deo Memorial
Science College, Nagpur.

Dharampeth M. P. Deo Memorial Science College, Nagpur
Department of Computer Science
Academic Session: 2022-2023
Quiz Competition: "MIND FEST 2022"
Notice

All the students are hereby informed that Computer Science Department is organizing Quiz competition " *MIND FEST 2022* " on 17th October 2022 at 1pm.

There will be online test on Basic Questions from Computer Science in room no 10 at 1pm
From this test 12 students for 4 teams will be selected. Each team will include one student from each year.

There will be 4 rounds for 4 teams.

- ❖ Rapid Fire (Round I)
- ❖ Logo recognition (Round II)
- ❖ Computer Science Scientists (Round III)
- ❖ General knowledge (Round IV)

Those students who are interested to participate will reach room no 10 at 12.45 pm sharp.
It is expected that all students will appear for the online test.

Thank you

Date: 15th October 2022

Mrs. Ruma Kapre
Convener

Dr. Mrs. Suchal Narale
HOD, Dept. of Comp. Sci.





DHARAMPETH M. P. DEO MEMORIAL SCIENCE COLLEGE,
North Ambazari Road, Near Ambazari Lake, Nagpur- 440033

DATA VALIDATION & VERIFICATION (DVV)

Name of the Programme : Quiz Competition "MIND FEST 2022"
Date of the Programme : 17/10/2022
Name of Chief Guest if any : _____
Name of Guest Speaker if any : _____

Sr. No.	Name of the Participant	Mobile Number	E-mail Id	Signature
1.	sujata.phanraj.souwane	9021135140	sujatasouwaneph001@gmail.com	<u>Sujata</u>
2.	Komal Manohar Kumbhakar	7620314869	kumbhakar.komal94@gmail.com	<u>Komal</u>
3.	Tanu Sanjay Mohule	7057844382	tanumohulehr@gmail.com	<u>Tanumohule</u>
4.	Mohit Harsh Khindekar	8035328357	mohitkhindekar@gmail.com	<u>Mohitkar</u>
5.	Ved. S. Choudhary.	97498572766	vedchoudhary.cs.709@gmail.com	<u>Ved</u>
6.	Badal G. Somkuwar.	7448247750	badalsomkuwar1@gmail.com	<u>Badal</u>
7.	Aman. S. Karm	9028837552	karm7817@gmail.com	<u>Aman</u>
8.	Vishal V. Girhale	8551994624	Vishalgirhale27@gmail.com	<u>Vishal</u>
9.	Akash Das	7972942799	das.akash021@gmail.com	<u>Akash</u>
10.	Saurabh V. Raut	9527281213	Saurabh.raut123@gmail.com	<u>Raut</u>

Signature of:

Rame
Programme In-charge

[Signature]
IQAC Coordinator

CO ORDINATOR
INTERNAL QUALITY ASSURANCE CELL
DHARAMPETH, M. P. DEO MEMORIAL &
SCIENCE COLLEGE, NAGPUR.

[Signature]
Principal

Dharampeth M.P. Deo Memorial
Science College, Nagpur.



DHARAMPETH M. P. DEO MEMORIAL SCIENCE COLLEGE,
North Ambazari Road, Near Ambazari Lake, Nagpur- 440033

DATA VALIDATION & VERIFICATION (DVV)

11	Sumeet Bhalekar	9021627757	sumitbhalakar262@gmail	
12	Dikshita Sahaie	9028830801	dikshitasahaie@gmail	
13	Khushi Gupta	9922997235	kg98120@gmail.com	
14	Rajit Rohad	9175635273	RajitRohad93@gmail	
15	Mukund Hood	9609785826	mukundhood@gmail	
16	Avishkar Anil Bansod	7820841788	avishkarbansod20@gmail	
17	Renuka V. Lanole	710951401	renukavlanole22@gmail	
18	Bhagyarathi Pandey	9175302601	pandeybhagyarathi@gmail	
19	Sumit Sable	9322410388	sumitsable256@gmail	
20	Devang Karia	7888238500	laddevang@gmail	

Signature of:

Program In-charge

IQAC Coordinator
COORDINATOR
INTERNAL QUALITY ASSURANCE CELL
DHARAMPETH, M. P. DEO MEMORIAL &
SCIENCE COLLEGE, NAGPUR

Principal
Principal
Dharampeth M.P. Deo Memorial
Science College, Nagpur.



DHARAMPETH M. P. DEO MEMORIAL SCIENCE COLLEGE,
North Ambazari Road, Near Ambazari Lake, Nagpur- 440033

DATA VALIDATION & VERIFICATION (DVV)

Name of the Programme : Quiz Competition "MIND FEST 2022"
Date of the Programme : 17/10/2022
Name of Chief Guest if any : _____
Name of Guest Speaker if any : _____

Sr. No.	Name of the Participant	Mobile Number	E-mail Id	Signature
1	Pranali Vipin Gupta	7020069377	ag99837@gmail.com	<u>Gupta</u>
2	Sagnati Fulkar	8767911307	sagnatifulkar@gmail.com	<u>df</u>
3	Janhvi Kishorappa	7058635243	janhvikishorappa@gmail.com	<u>Kishorappa</u>
4	Prachya Tripathi	8010362232	prachyatripathi914@gmail.com	<u>Pr</u>
5	Samiksha Panchbudhe	9763075890	samikshapanchbudhe363@gmail.com	<u>S Panchbudhe</u>
6	Aditi Jogi	9579962108	aditi.jogi2002@gmail.com	<u>Aditi</u>
7	Samiksha Shende	7420881158	samikshashende08@gmail.com	<u>Shende</u>
8	Pratiksha Borse	9579836818	pratikshaborse49@gmail.com	<u>Pratikshaborse</u>
9	Vaidehi Nagolkar	9325963446	vaidehinagolkar17@gmail.com	<u>Vaidehi</u>
10	Divyani Zade	7972403069	divyanizade2005@gmail.com	<u>Zade</u>

Signature of:

Pr
Programme In-charge

Pr
IQAC Coordinator
CO ORDINATOR
INTERNAL QUALITY ASSURANCE CELL
DHARAMPETH, M. P. DEO MEMORIAL &
SCIENCE COLLEGE, NAGPUR

Pr
Principal
Principal
Dharampeth M.P. Deo Memorial
Science College, Nagpur,



DHARAMPETH M. P. DEO MEMORIAL SCIENCE COLLEGE,
North Ambazari Road, Near Ambazari Lake, Nagpur- 440033

DATA VALIDATION & VERIFICATION (DVV)

11	Prachi Gaurishankar Pardhi	7263935912	prachipardhi282@gmail.com	Prachi
12	Monali Narendrajji Shende	7796516257	shendemonali92@gmail.com	Monali
13	Sonia Sanjay Niwal	7058425021	nwalsonia72@gmail.com	Sonia
14	Devashree prandus karkole	9021344265	praddevashree@gmail.com	Devashree
15	Veena Borikar	9322016921	veenaborikar4@gmail.com	Veena
16	Vansha Tukkar	9373650950	vanshatukkar488@gmail.com	Vansha
17	Rutika Yadav	8446085943	yadavarutika454@gmail.com	Rutika
18	Ishita Deshpande	9130091540	ishitadeshpande@gmail.com	Ishita
19	Janhvi Laibey	8446510539	Janhvilaibey@gmail.com	Janhvi
20	Janhvi Toje	7385060971	JhanJanhviToje08@gmail.com	Janhvi
21	Neha J. Bankar	8055477553	neha2002bankar@gmail.com	Neha

Signature of:

Programme In-charge

IQAC Coordinator

CO ORDINATOR
INTERNAL QUALITY ASSURANCE CELL
DHARAMPETH, M. P. DEO MEMORIAL &
SCIENCE COLLEGE, NAGPUR

Principal

Principal
Dharampeth M.P. Deo Memorial
Science College, Nagpur.

Dharampeth M. P. Deo Memorial Science College, Nagpur

Department of Computer Science

Academic Session: 2022-2023

Quiz Competition: "MIND FEST 2022"

Result Sheet

Team	Name of the Student	Semester	Group	Round I (Rapid Fire)	Round II (Logo Recognition)	Round III (CS Scientists)	Round IV (General Knowledge)	Total
A	Varsha Lekshram Turkar	I	SCOM	0+0 +0 10	0+0+ 0 10	0+0+ 0 10	0+0+ 0 10	0
	Avishkar Anil Bansod	III	SCOM					
	Komal Manohar Kumbhare	V	SCOM					
B	Veena Uhas Borikar	I	SCOM	0+0+ 0 10	3+0+ 0 13	3+0+ 0 13	0+0+ 0 10	6
	Sumit Vijay Sable	III	SCOM					
	Tanu Sanjay Mohurle	V	SCOM					
C	Mohit Maroti Khirdekar	I	SCOM	0.5 10.5	3+3+ 0 6	3+3+ 0 6	3+0+ 2 15	17.5 18
	Renuka Vishal Lande	III	ECOM					
	Neha Jagdish Bankar	V	SCOM					
D	Janhvi Hemant Laibet	I	SCOM	0+0+ 0 10	0+0+ 0 10	0+0+ 0 10	0+0+0 10	0
	Bhagyarathi Ramvinay Pandey	III	ECOM					
	Sujata Dhanraj Sonwane	V	SCOM					

Rume
Mrs. Ruma Kapre
Convener



DHARAMPETH M. P. DEO MEMORIAL SCIENCE COLLEGE, NAGPUR

INTERNAL QUALITY ASSURANCE CELL (IQAC)

Activity Report

Date: 17th October 2022

Name of Organizing Department or Committee : Electronics Department
Name of the Activity : Simple Programs using Branching instructions using Simulator(NEP)
Suggested CRITERION point if any : Suggested criteria II
Date of Activity: 17th October 2022
Place of Activity : Electronics Lab

Name of Guest Speaker/s or Judge/s or Chief Guest/s if any : Not applicable

Title of the Activity: Simple Programs using Branching instructions using Simulator
Based on Unit : 3(Paper II)
Class : Semester V
Number of Participants: 29

Name of the Teacher In-charge / Convener: Prof. V. V. Rangari

OUTCOME of the Activity with respect to mission vision of the institute and or academics:

Students learn how to use the Simulator for 8085 Microprocessor Programming and done simple programs using branching instructions. The instructions from the branching group were studied by the students.

Prof. Varsha V. Rangari

Head of the Department



Prof. Pitambar Humane

IQAC Coordinator

CO ORDINATOR

INTERNAL QUALITY ASSURANCE CELL,
DHARAMPETH, M. P. DEO MEMORIAL &
SCIENCE COLLEGE, NAGPUR



Dr. Akhilesh Peshwe

Principal
Principal
Dharampeth M.P. Deo Memorial
Science College, Nagpur.



Dharampeth M. P. Deo Memorial Science College,
Nagpur

Electronics Department
Semester V - (2022-23)

Activity 3

Based on Paper II -Unit 3

Date: 17/10/22

Activity: Simple Programs using Branching instructions in Simulator

Objective:

- To Know the use of branching instructions.

Sr. No.	Students Name	Signature
1.	Akash Kamal Kishan Dubey	
2.	Aruni B. Singh	
3.	Megha T. Bisen	
4.	Mukund S. Hood	
5.	Nikhil K. Jankar	
6.	Pranav Mahapatra	
7.	Kartik K. P. Tiwari	
8.	Ankur D. Singh	
9.	Ankit Singh	
10.	Maran R. Waghmare	
11.	Mahesh P. Maske	
12.	ANHEJAT S. MAMAR	
13.	Bhavesh R. Maske	
14.	Prakash Pranal	
15.	Shounak Balkundi	
16.	Saurabh P. Sharma	
17.	Tanmay S. Gadani	
18.	Riddhi A. Rajkumar	



DHARAMPETH M. P. DEO MEMORIAL SCIENCE COLLEGE, NAGPUR

Department of Electronics

Semester III- (2022-23)

ACTIVITY (PAPER II – UNIT 3)

Sr. No.	Student Name	Mobile No.	Email ID
1	Urvashi Sunilrao Umathe	9527708361	pragatichaure01@gmail.com
2	Jay Anilbhai Patil	7385436956	jay.patil0326@gmail.com
3	Janvi Ashok Kosarkar	8975756916	Janvikosarkar@gmail.com
4	Chetan Umashankar Bopche	9172484628	chetanbopche27@gmail.com
5	Yash Ravindra Khedekar	7020829422	yashkhedekar5@gmail.com
6	Rahul Ramesh Kawade	9359525716	kawaderahul042@gmail.com
7	Mansi Dilip Nandanwar	7709322027	mansinandanwar19@gmail.com
8	Renuka Vishal Lande	7719951401	renukalande220@gmail.com
9	Aasmin Abdulhalik Sheikh	8788490684	abdulhalik563698@gmail.com
10	Aditya Ravindra Singh	8999323047	aditya8999singh@gmail.com
11	Sandip Lotan Funde	9067118437	sandipfundesmc@gmail.com
12	Tushar Wadhawe		
13	Pawankumar Shivkumar Vishwakarma	7058408869	pawanvishwakarma67448@gmail.com
14	Unnatitai Chatrapal Chopde	9022627617	unnatichopde2002@gmail.com
15	Durgesh Krishna Singh	7385310432	ds608531@gmail.com
16	Bhagyarathi Ramvinay Pandey	9175302601	pandeybhagyarathi@gmail.com

Name & Signature of Teacher In-Charge

Prof. Pitambar Humane
IQAC Coordinator

CO ORDINATOR
INTERNAL QUALITY ASSURANCE CELL
DHARAMPETH, M. P. DEO MEMORIAL &
SCIENCE COLLEGE, NAGPUR

Name & Signature of Head of the Department

Jr. Varsha V Rangari
Professor & Head
Department of Electronics
Dharampeth M.P. Deo Memorial
Science College, Nagpur

Dr. Akhilesh Peshwe
Principal

Principal
Dharampeth M.P. Deo Memorial
Science College, Nagpur.



DHARAMPETH M. P. DEO MEMORIAL SCIENCE COLLEGE, NAGPUR
INTERNAL QUALITY ASSURANCE CELL (IQAC)

Activity Report

Date: 17-10-2022

Name of Organizing Department or Committee: Department of Statistics.

Name of the activity: Constructing frequency distribution table.

Suggested CRITERION point if any:

Date of Activity: 17 october 2022

Place of Activity: Statistics lab

Name of Guest Speaker/s or Judge/s or Chief Guest/s if any:

Title of the Activity: Constructing frequency distribution table.

Number of Participants: 23

Name of the Teacher: Durga hingwe

Names of other Committee Members / Staff: N.A.

OUTCOME of the Activity with respect to mission vision of the institute and or academics:

A frequency distribution table displays the frequency of each data set in an organized way. It helps us to find patterns in the data and also enables us to analyze the data using measures of central tendency and variance.

Activity with newspaper coverage if any: No

Activity data save in PC of: Department of Statistics

Prof. Pitambar Humane
IQAC Coordinator

CO ORDINATOR
INTERNAL QUALITY ASSURANCE CELL
DHARAMPETH, M. P. DEO MEMORIAL &
SCIENCE COLLEGE, NAGPUR

Name & Signature of Teacher In-charge

Dr. Akhilesh Peshwe
Principal

Dharampeth M.P. Deo Memorial
Science College, Nagpur.



DHARAMPETH M. P. DEO MEMORIAL SCIENCE COLLEGE NAGPUR

Department of Statistics

Class: B.Sc. Sem.-I

NEP ACTIVITY

Paper- II

Unit- I

Name of the Teacher: Durga C. Hingwe

Date: 17-10-2022

Title of Activity: Constructing frequency distribution table

Sr. No.	Name of Student	Batch	Mobile No.	Email ID	Signature
1.	Dhyanji V. Zagade	F2	9022866318	dhyanji.zagade@gmail.com	Durga
2.	Janvi V. Ichode	F2	7385066697	JanviIchode@gmail.com	Janvi
3.	Pranali R. Dehankar	F2	8767581278	PranaliR@gmail.com	Pranali
4.	Nisha S. Kulkarni	F2	9690995646	nishas.kulkarni@gmail.com	Nisha
5.	Utkarsha S. Trigale	F2	7499159178	utkarshas.trigale@gmail.com	Utkarsha
6.	Vidya Lohi	F2	7020963219	Vidyalohi8@gmail.com	Vidya
7.	Sakshi Mishra	F2	9529889315	Sakshimishra93@gmail.com	Sakshi
8.	Janvi Laibey	F2	8446510539	Janvilaihey@gmail.com	Janvi
9.	Rudika Yadav	F2	8446085949	yadavrudika49@gmail.com	Rudika
10.	Maiti Kulkarni	F2	9055328357	maitikulkarni@gmail.com	Maiti
11.	Veena Berikar	F2	9322016921	veenaberikar@gmail.com	Veena
12.	Janvi Jage	F2	7385060771	Janvijage08@gmail.com	Janvi
13.	Pranali Gupta	F2	7020069377	pranali91539@gmail.com	Pranali
14.	Jagruti Fullkavar	F2	8707911907	Jagrutifullkavar@gmail.com	Jagruti
15.	Sonia Niwal	F2	7058425021	niwalsonia970@gmail.com	Sonia
16.	Chetna Buniie	F2	8010942961	buniiechetna@gmail.com	Chetna
17.	Dewashri Kakde	F2	9021344265	kakdedewashri@gmail.com	Dewashri
18.	Janvi A. Kisanapur	F2	7058235249	janvikisanapur@gmail.com	Janvi
19.	Pradnya L. Tarpude	F2	8010362232	pradnyal.tarpude9145@gmail.com	Pradnya
20.	Vivek S. Sah	F1	9923763071	Vivek.Sah1878@gmail.com	Vivek
21.	Nayan N. Walthare	F4	7841870947	NayanWalthare19@gmail.com	Nayan
22.	Ishita Deshpande	F2	9130091546	ishitan.deshpande21004@gmail.com	Ishita
23.	Varsha Turkar	F2	9373650150	varshaturkar4520@gmail.com	Varsha

Durga C. Hingwe
Signature of Teacher

Durga C. Hingwe
Teacher Incharge



DHARAMPETH M. P. DEO MEMORIAL SCIENCE COLLEGE, NAGPUR
INTERNAL QUALITY ASSURANCE CELL (IQAC)

Date: 17/10/2022

Name of Organizing Department or Committee: Home Science Department

Name of the activity: Assignment on Enlist the material for Interior Decoration and indigenous material (NEP Activity)

Suggested CRITERION point if any: Criteria II & V

Date of Activity: 17/10/2022

Place of Activity: Classroom

Name of Guest Speaker/s or Judge/s or Chief Guest/s Resource Person if any:

Title of the Activity: Assignment on Enlist the material for Interior Decoration and indigenous material (NEP Activity)

Number of Participants: 11 students of Semester Ist participate in the activity.

Name of the Teacher In-charge / Convener: Ms. Ankita Wankhede

Names of other Committee Members / Staff: Mrs. Manju Deshpande

OUTCOME of the Activity with respect to mission vision of the institute and or academics:

1. Students learn and gather information about Interior décor materials.

Activity with newspaper coverage if any: _____

Activity data save in PC of: Home Science Staff Room Desktop

Note: Kindly share geotag photographs separately along with report on iqacdsc2022@gmail.com

Prof. Pitambar Humane
IQAC Coordinator
CO ORDINATOR
INTERNAL QUALITY ASSURANCE CELL
DHARAMPETH, M. P. DEO MEMORIAL &
SCIENCE COLLEGE, NAGPUR

Name & Signature of Teacher In-charge

Dr. Akhilesh Peshwe
PRINCIPAL
Dharampeth M. P. Deo Memorial
Science College, Nagpur.



DHARAMPETH M. P. DEO MEMORIAL SCIENCE COLLEGE,
North Ambazari Road, Near Ambazari Lake, Nagpur- 440033

DATA VALIDATION & VERIFICATION (DVV)

(Sem II)

Name of the Programme : Assignment on Enlist the material for ID & Indigenous material.
Date of the Programme : 17/10/2022
Name of Chief Guest if any : _____
Name of Guest Speaker if any : _____

Sr. No.	Name of the Participant	Mobile Number	E-mail Id	Signature
1	Aditi R. Vaidya	9075714591	aditivaidya619@gmail.com	Ad
2	Shaku L. Paidhi	8329115380		Shaku
3	Minal L. Patte	7330730164	patteminal83@gmail.com	Minal
4	Ashwini N. Pandey	8308621072	ashwinipandey229@gmail.com	Ad
5	Neha R. Vishwakarma	8983634175	nehavishwakarma528@gmail.com	Neha
6	Anshikha U. Jaiswarikar	9021391207	anshikhajaiswarikar@gmail.com	Anshikha
7	Prerna J. Chaudhari	7620384149	chaudhasiprerna294@gmail.com	Prerna
8	Hemlata D. Verma	7517058379	vermahemlata957@gmail.com	H. Verma
9	Gayatri N. Varma	9763284581	gayatri.varma060@gmail.com	Gayatri
10	Shubhangi R. Nishad	9519534076	shubhishad25@gmail.com	Shubhat
11	Bhavana G. Wadasoni	8888937303	bhavanagwadasoni@gmail.com	Bhavana

Signature of:

Programme In-charge

COORDINATOR
INTERNATIONAL INSURANCE CELL
DHARAMPETH, M. P. DEO MEMORIAL &
SCIENCE COLLEGE, NAGPUR

PRINCIPAL
Dharampeth M. P. Deo Memorial
Science College, Nagpur.



**DHARAMPETH M. P. DEO MEMORIAL SCIENCE COLLEGE, NAGPUR
INTERNAL QUALITY ASSURANCE CELL (IQAC)**

Activity Report

Date: 20/10/2022

Name of Organizing Department or Committee: Microbiology Department

Name of the activity: TWO DAYS WORKSHOP AT HORIBA

Suggested CRITERION point if any: Criterion II

Date of Activity: 18th & 19th October 2022

Place of Activity: Horiba International Training Centre, Buttibori, Nagpur.

Name of Guest Speaker/s or Judge/s or Chief Guest/s if any: Guest Speaker- Dr. Pushkar Admane, Head, Horiba Medical Technology and Principal, Dr. Ruzbeh Modawala, & Jaldeep Bhansali

Title of the Activity: A two-day workshop on-"Hands on Training in Advance Lab Equipment" at Horiba International Training Centre, Buttibori

Number of Participants: 53

Name of the Teacher In-charge / Convener: Dr. Vidya R. Kathoke

Names of other Committee Members / Staff: Dr. Vaishali Pimple, Dr. Pratiksha Pohekar, Diksha Zade

OUTCOME of the Activity with respect to mission vision of the institute and or academics:

1. The students get exposed to the international standards and etiquettes
2. It helps them to learn about advanced technology, how automated machines used for laboratory diagnosis giving results in few minutes.
3. Since its hands on training the students enjoyed practical learning on automated machines by using their own samples of blood, thus got updated knowledge about their own healthiness.
4. Many students show their willingness to join this institute in future.



Activity with newspaper coverage if any:

https://m.facebook.com/story.php?story_fbid=ofbid02dbrti734tNbGunZwWP7pXMJwhPdLxVgozn1m9FSqx69wpsahhzu9is5p69GauKRYl&id=100064142527387

Prof. Pitambar Humane
IQAC Coordinator

Dr. Vidya R. Kathoke
Name & Signature of Teacher In-charge

Dr. Akhilesh Peshwe
Principal

B.Sc Work Shop Training Program

2 Days
12 hours

NOTICE:

18th & 19th Oct. 2022

(ONLY FOR SEM-V)

Code
SPE BSC USE EN2D

Training main objectives

- Be able to Operate Biochemistry analyzer, Hematology analyzer and Coagulation analyzer:
- Maintenances
- Testing
- Troubleshooting



Skills targeted

At the end of the training course, the attendee should understand the basic of Hematology, Coagulation and Biochemistry, should analyze the samples on analyzers and identify the alarm is due to Technical, clinical or pre-analytical problems, performing maintenances and independently ensure the consistency of the devices optimal performances.

Learning methods
Theoretical description
Instrument practice
Maintenance practice

B.Sc Work Shop Training Program

2 Days
12 hours



Date: 18th & 19th Oct 2022
Tuesday & Wednesday
Class: Sem V

Duration and Schedule

The training takes place on 2 days, begins at 9:30 A.M. and ends at 5:30 P.M. daily.

Day 1:

Introduction of HORIBA, Advanced Hematology and Coagulation, Hands on Training in Advance lab equipment at Horiba International Training centre

- 09:30 AM to 09:45 AM : Introduction of HORIBA
- 09:45 AM to 10:00 AM : Tea Break
- 10:00 AM to 11:30 AM : Understanding Medical laboratory and basics of Haematology.
- 11:30 AM to 1:00 PM : Basics of Coagulation
- 1:00 PM to 2:00 PM : Lunch
- 2:00 PM to 3:30 PM : Hands on Training - Haematology.
- 3:30 PM to 3:45 PM : Tea Break
- 3:45 PM to 5:30 PM : Hands on Training - Coagulation

Day 2:

Advanced Biochemistry, Hands on Training in Advance lab equipment at Horiba International Training centre , Soft skills and felicitation

- 09:00 AM to 10:30 AM : Basics of Biochemistry
- 10:30 AM to 10:45 AM : Tea Break
- 10:45 AM to 1:00 PM : Hands on Training Biochemistry (Parameter programming and Performing Tests)
- 1:00 PM to 2:00 PM : Lunch Break
- 2:00 PM to 3:30 PM : Soft Skills on Effective communication and Professional Etiquette
- 3:30 PM to 3:45 PM : Tea Break
- 3:45 PM to 4:30 PM : Felicitation and certificate distribution



One Company
One Training Standard

HORIBA
MEDICAL

<http://www.horiba.com/in>

HORIBA India Pvt. Ltd.
Plot.No: B-3 & C-32,
MIDC Butibori Phase-II,
Industrial Area
Nagpur-441122-INDIA

Mobile: +919652234888
suthram.subramanyam@horiba.com



DHARAMPETH M. P. DEO MEMORIAL SCIENCE COLLEGE,
NORTH AMBAZARI ROAD, NEAR AMBAZARI LAKE, NAGPUR - 440033

Day 1

DATA VALIDATION & VERIFICATION (DVV) BATCH - T-15

Name of the Programme : Two days Workshop Training Program in Advance Lab Equipments at HONEDA
Date of the Programme : 18th Oct 2022 Day 1
Name of Chief Guest if any : _____
Name of Guest Speaker if any : _____

Sr. No.	Name of the Participant	Mobile No.	E-mail Id	Signature
1	Aarti Babulal Bisen	8767549078	aarti'bisen125@gmail.com	
2	Aditi Raja Tiple	9763886643		
3	Aishwarya Anand Joshi	8956169223	aishwaryajoshi2003@gmail.com	
4	Ankita Ramesh Bhoyar	8788031173	ankita.1234	
5	Arpita Dilip Gaydhane	9527250282	arpitagaydhane@gmail.com	
6	Bhargavi Abhijeet Sambare	7709403806	bhargavisambare15@gmail.com	
7	Bhushan Naresh Harshe	7397842243	bhushan.harshe1415	
8	Isha Birendraprasad Gupta	9373109537	Isha1202gupta@gmail.com	
9	Karishma Suresh Bansod	7389812507	Karishmabansod40@gmail.com	
10	Laxmi Mukeshrao Gorle	7758058514	laxmigorle2002@gmail.com	
11	Neha Jitendra Chandratre	9156873792	nehachandratre346@gmail.com	

Signature of

Programme In-Charge

IQAC Coordinator

Principal
Dharampeth
Principal, Deo Memorial
Science College Nagpur

Day 7 18/10/2022



DHARAMPETH M. P. DEO MEMORIAL SCIENCE COLLEGE,
North Ambazari Road, Near Ambazari Lake, Nagpur-440033

DATA VALIDATION & VERIFICATION (DVV)

Name of the Programme : Two days Work shop Training Program in Advance Lab Equipments
Date of the Programme : 18th & 19th October 2022
Name of Chief Guest if any : _____
Name of Guest Speaker if any : _____

Sr. No.	Name of the Participant	Mobile Number	E-mail Id	Signature
	Arijali Pali	7498102109	paliarijali446@gmail.com	
	Ayushi Shukla	9373668043	ayushishukla28112002@gmail.com	
	Anushui Wele	8530778433	anushuiwele2001@gmail.com	
	Bhumika Chedge	8830391103	bhumikachedge@gmail.com	
	Bhushan Hashe	7337842243	bhushanhashe7481@gmail.com	
	Om Singh	9923993661	om.singh.24452@gmail.com	
	Sayali Lakhande	9356413804	SayaliLakhande2910@gmail.com	
	Samiksha Choudhary	7517090406	Choudharysamiksha26@gmail.com	
	Samiksha Kundekar	9145253758	samikshakundekar@gmail.com	
	Shreyansh Naikwar	7447844189	shreyanshnaikwar@gmail.com	

Signature of:

Program In-charge

IQAC Coordinator

Principal
Dharampeth M. P. Deo Memorial Science College



DHARAMPETH M. P. DEO MEMORIAL SCIENCE COLLEGE,
North Ambazari Road, Near Ambazari Lake, Nagpur- 440033

DATA VALIDATION & VERIFICATION (DVV)

	Madhura Unesh Bhandure	8767484914	Madhurabhandure@gmail.com	Mkbhandure
	Rinam Chavandas Wankhede	8010966529	wankhederinamo7@gmail.com	Rinamhedge
	Roshani Madhav Bambal	9325853408	Roshani2018@gmail.com	Rbambal
T14-	Ishika Sanjay Thakre	8010907069	ishithakre22@gmail.com	Ishika
T14-	Nandini Hodge	9370301679	nandinihodge17@gmail.com	Nhodge
T15-	Bhargavi Sambhare	7709403806	bhargavisambhare05@gmail.com	Bsb.
T14-	Lakshmi Gole	7758058514	laxmigele9308@gmail.com	Lgole
	Krushnali Kadu	8625854995	krushnalikaduf@gmail.com	Kkadu
T14-	Manish S. Grade	9370929857	Manishgrade79@gmail.com	Mgrade
	Rupesh W. Wadde	9329676611	Rupeshwadde7@gmail.com	Rwadde
	Babraj M. Neda-	9420391582	Babrajneda@gmail.com	Bneda
	Avanti Chaphekar	782573847	avanti911@gmail.com	Avanti
	Astha Sakhaswade	9405197842	asthasakhaswade@gmail.com	Asakhaswade
	Bronjali Dande	9325473318	dandebronjalie@gmail.com	Bdande
	Ojaswini Bhagat	7558367348	shardabhagat452@gmail.com	Ojhaswini

Signature of:

Kathake
Programme In-charge

IQAC Coordinator

Principal



DHARAMPETH M. P. DEO MEMORIAL SCIENCE COLLEGE,
North Ambazari Road, Near Ambazari Lake, Nagpur - 440033

DATA VALIDATION & VERIFICATION (DVV)

T-15.

T-15	Shruti M. Pawar	9527988707	shrutipawar0707@gmail.com	S.Pawar
T-14	Suraj S. Jodan	8767435158	surajshyamjodan82@gmail.com	Shett
T-14	Soukhal Iode	7972085380	SoukhalIode122@gmail.com	Soukhal
T-14	Tanmay Chaudhari	8600102341	tchaudhari8600@gmail.com	Tanmay
T-13	Vivek R. Wadhwani	8956482591	vivekchaudhari@gmail.com	Vivek
T-13	Shiwani P.R. Dwivedi	8855900546	shiwani.dwivedi41@gmail.com	Shiwani
T-14	Sevanti M. Gaikwad	7385532705	krushnigaikwad8035@gmail.com	Gaikwad
T-13	Suman. A. Singh	7249465307	missumansingh3@gmail.com	Suman
T-13	Krushnali S. Kadu	8625854995	krushnalikadu67@gmail.com	Kadu
T-15	Aishwarya A. Joshi	7498328662	aishwaryajoshi2002@gmail.com	Ashish
T-14	Tejas G. Solanke	7030730670	tejasolank-208@u	Solanke
T-15	Siddha M. Kathole	8329758490	siddhakathole5@gmail.com	Siddha
T-14	Manish S. Grade	9370329857	manishgrade79@gmail.com	Grade
T-13	Sanskriti S. Panchbhane	7447613185	sanskritipanchbhane@gmail.com	Panchbhan

Signature of:

Programme In-charge

IQAC Coordinator

Principal
Dharampeth M. P. Deo Memorial
Science College, Nagpur



19/10/2022

DHARAMPETH M. P. DEO MEMORIAL SCIENCE COLLEGE,
NORTH AMBAZARI ROAD, NEAR AMBAZARI LAKE, NAGPUR – 440033

Day 2

DATA VALIDATION & VERIFICATION (DVV)

Sr. No.	Name of the Participant	Mobile No.	E-mail Id	Signature
12	Poonam Sunil Chauragade	8767765121		
13	Pranjali Laxmikant Dande	9325473318	dandehranjali6@gmail.com	P. Dande
14	Roshani Madhav Bambal	9325853408	roshanizoshb@gmail.com	R. Bambal
15	Rupesh Wale Wadde	8329676611	Rupeshwadde78@gmail.com	R. Wadde
16	Samiksha Narendra Kundekar	9145253758	Samikshakundekar@gmail.com	S. Kundekar
17	Samiksha Ramchandra Choudhari	7517090406	choudharisamiksha26@gmail.com	S. Choudhari
18	Suman Ashutosh Singh	7249465307	missuman Singh@gmail.com	S. Singh
19	Sayli Sevanand Lokhande	9356413804	Sayli Lokhande2510@gmail.com	S. Lokhande
20	Shiwani Shriraman Dwiwedi	8855900546	shiwandwiwedi41@gmail.com	S. Dwiwedi
21	Shreyansh Surendra Naikwar	6268750014	shreyanshnaikwar@gmail.com	S. Naikwar
22	Vivek Ramkrushna Wahurwagh	8956482591	Vivek Wahurwagh@gmail.com	V. Wahurwagh
23.	Pankhuri S. Panchbhare	7447613185	pankhurispanchbhare@gmail.com	P. Panchbhare
24.	Rinam C Wankhede	8010966529	Wankhederinam07@gmail.com	R. Wankhede
25.	Krushnati S Kadam	8625854995	Krushnatisadam@gmail.com	K. Kadam

Signature of

Programme In-Charge

IQAC Coordinator

Principal

Dharampeth M. P. Deo Memorial
Nagpur



DHARAMPETH M. P. DEO MEMORIAL SCIENCE COLLEGE,
NORTH AMBAZARI ROAD, NEAR AMBAZARI LAKE, NAGPUR – 440033

DATA VALIDATION & VERIFICATION (DVV) BATCH-T-13

Name of the Programme : BSc Work shop Training Program at HORIBA, Buttibari
Date of the Programme : 18 & 19 October 2022
Name of Chief Guest if any : _____
Name of Guest Speaker if any : _____

Sr. No.	Name of the Participant	Mobile No.	E-mail Id	Signature
1	Anjali Ramkumar Pali	7498102109	pallanjalii46@gmail.com	
2	Anushri Shrikant Wele	8530778433	anushriwele2001@gmail.com	
3	Astha Abhay Sakharwade	9405197842	asthasakharwade@gmail.com	
4	Avanti Ashish Chaphekar	7875173847	avanti1011@gmail.com	
5	Ayushi Omprakash Shukla	9373668043	ayushishukla29112002	
6	Balraj Mangru Welda	9420396682	balrajwelda4@gmail.com	
7	Bhumika Devendra Chedge	8830391103	bhumikachedge@gmail.com	
8	Krushnali Sanjay Kade	8625854994	krushnalikedu07@gmail.com	
9	Madhura Umesh Bhondwe	8767484914	Madhurasb.bhondwe@gmail.com	
10	Ojaswini Raju Bhagat	7558367348	shardabhagat45@gmail.com	
11	Om Rajkumar Singh	9923993661		

Signature of

Programme In-Charge

IQAC Coordinator

Principal

Principal
Dharampeth M. P. Deo Memorial
Science College, Nagpur



DHARAMPETH M. P. DEO MEMORIAL SCIENCE COLLEGE,
NORTH AMBAZARI ROAD, NEAR AMBAZARI LAKE, NAGPUR - 440033

DATA VALIDATION & VERIFICATION (DVV) BATCH - T-14

Name of the Programme : Two day Workshop on hands on Training in Advance Lab Equipments at DRPDSVM
Date of the Programme : 19/10/2022
Name of Chief Guest if any : _____
Name of Guest Speaker if any : _____

Sr. No.	Name of the Participant	Mobile No.	E-mail Id	Signature
1	Ishika Sanjay Thakre	8010907069	ishithakre@gmail.com	
2	Laxmi Mukeshrao Gorle	7758058514	laxmigorle2018@gmail.com	
3	Manali Satish Shinde	7249637434	manalishinde062@gmail.com	
4	Nandini Purushottam Pounikar	9764359642	nandini.pounikar@gmail.com	
5	Nandini Suresh Hadge	9370301679	nandini.hadge17@gmail.com	
6	Pranjali Nagesh Gaikwad	9130893362	gaikwadpranjali39@gmail.com	
7	Sadaf Parveen Akabar Sheikh	9673410401	Sheikhscdof934@gmail.com	
8	Sanket Kailash Lode	7972085380	Sanketlode123@gmail.com	
9	Suraj Shyam Yadav	8767435158	Surajshyam.yadav252@gmail.com	
10	Tanmay Yadav Choudhari	8600102341	tanmayyadavchoudhari@gmail.com	

11 Mounish Sureshwar Gorle 9370309857 mounishgorle75@gmail.com @Drade
12 Tejas G. Solanki 7030730670 tejasdanki2018@gmail.com

Programme In-Charge

IQAC Coordinator

Principal
Dharampeth M. P. Deo Memorial
Science College Nagpur

Date 19/10/2022

To,
Director,
Horiba India Private Limited, Nagpur.

Subject: Letter of thanks to Horiba India Pvt. Ltd.

On behalf of Dharampeth M.P. Deo Memorial Science College, Nagpur, I would like to extend my thanks to Horiba India Private Ltd. Nagpur for providing hands on training to the Students of our college in Haematology, Coagulation studies, Biochemistry(Parameter programming and Performing Tests), and soft skills , effective communication and professional Etiquettes on the dates 18th &19th October 2022.

It was a great learning experience for the students which will be very useful to them in their career. In future expect same type of learning collaborations from Horiba.

Thank You,

Dr. Vidya R. Kathoke

HOD,

Department of Microbiology.

Dr. V. R. Kathoke
Head
Deptt. of Microbiology
Dharampeth MP Deo Memorial
Science College, Nagpur



Name of the Department : Microbiology

Name of Activity: Two Day Workshop on Hands on Training Batch - BSc Sem VDate: 18.10.2022

Sr. No.	Name of Student	Contact No.	E-mail ID	Signature
1	Aarti Babulal Bisen	8767549078	aartibisen12@gmail.com	A Bisen
2	Aditi Raja Tiple	9763886643		
3	Aishwarya Anand Joshi	8956169223	aishwaryajoshi2003@gmail.com	Aishwariya
4	Anjali Ramkumar Pali	7498102109	paliyanjali46@gmail.com	Anjali
5	Ankita Ramesh Bhojar	8788031173	ankitapali@gmail.com	Ankita
6	Anushri Shrikant Wele	8530778433	anushriwele20@gmail.com	Anushri Wele
7	Arpita Dilip Gaydhane	9527250282	arpitagaydhane@gmail.com	Arpita
8	Astha Abhay Sakharwade	9405197842	asthaabharwade@gmail.com	Astha
9	Avanti Ashish Chaphekar	7875173847	avanti1011@gmail.com	Avanti
10	Ayushi Omprakash Shukla	9373668043	ayushishukla28112002@gmail.com	Ayushi
11	Balraj Mangru Welda	9420396682	balrajwelda4@gmail.com	Balraj
12	Bhargavi Abhijeet Sambare	7709403806	bhargavisambare05@gmail.com	Bhargavi
13	Bhumika Devendra Chedge	8830931103	bhumikachedge@gmail.com	Bhumika
14	Bhushan Naresh Harshe	7397842243	bhushanharshe14811	Bhushan
15	Isha Birendraprasad Gupta	9373109537	Isha202gupta@gmail.com	Isha
16	Ishika Sanjay Thakare	8010907069	ishithakare22@gmail.com	Ishika
17	Karishma Suresh Bansod	7389812507	karishmabansod401@gmail.com	Karishma
18	Krushnali Sanjay Kade	8625854994	krushnali2004@gmail.com	Krushnali
19	Laxmi Mukeshrao Gorle	7758058514	laxmigorle1998@gmail.com	Laxmi
20	Madhura Umesh Bhondwe	8767484914	MadhuraBhondwe@gmail.com	Madhura
21	Manali Satish Shinde	7249637434	manalishinde062@gmail.com	Manali
22	Nandini Purushottam Pounikar	9764359642	nandinipounikar@gmail.com	Nandini
23	Nandini Suresh Hadge	9370301679	nandinihadge17@gmail.com	Nandini
24	Neha Jitendra Chandratre	9156873792	nehachandratre34@gmail.com	Neha

[Signature]
Teacher In-charge

Sr. No.	Name of Student	Contact No.	E-mail ID	Signature
25	Manali Satish Shinde	7249637434	Manalishinde062@gmail	
26	Nandini P. Pounikar	9764359642	nandnipounika@gmail.com	
27	Nandini Suresh Hadge	9370301679	nandinihadge12@gmail.com	
28	Ojaswini Raju Bhagat	7558367348	shantabhagat45@gmail.com	
29	Om Rajkumar Singh	9923993661		
30	Poonam Sunil Chauragade	8767765121		
31	Pranjali Laxmikant Dande	9325473318	landekhanjali@gmail.com	
32	Pranjali Nagesh Gaikwad	9130893362	gaikwadpranjali33@gmail.com	
33	Riddhi M. Bharadwaj	7972613061	riddhi.bharadwaj2015	
34	Roshani Madhav Bambal	9325853408	roshanihb@2018bb@gmail.com	
35	Rupesh Wale Wadde	8329676611	Rupeshwadde18@gmail.com	
36	Sadaf Perveen Akbar Sheikh	9673410401	sheikhsadaf93@gmail.com	
37	Samiksha N. Kundekar	9145253758		
38	Samiksha R. Choudhari	7517090406	choudharisamiksha29@gmail.com	
39	Sanket Kailash Lode	7972085380	Sanketlode123@gmail.com	
40	Suman Ashutosh Singh	7249465307	missumansingh@gmail.com	
41	Sayli Sevanand Lokhande	9356413804	sayalilokhande29@gmail.com	
42	Shreyansh Surendra Naikwar	6268750014	shreyanshnaikwar7@gmail.com	
43	Shruti Madan Gaikwad	7385532705	shrutigaikwad8635@gmail.com	
44	Shruti Maroti Pawar	9527988707	shrutipawar7@gmail.com	
45	Siddha Moreshwar Kathale	8329758490	Siddhakathale5@gmail.com	
46	Suhani Pralhad Indurkar	9370419064	suhaniindurkar99@gmail.com	
47	Suraj Shyam Yadav	8767435158	Surajshyam.yadav52@gmail.com	
48	Tanmay Yadav Choudhari	8600102341	tanmaychoudhari27@gmail.com	
49	Vaidehi Bandu Kodmalwar	8788245910	Vaidehikodmalwar@gmail.com	
50	Vaishnavi K. Kharkate	97632856915		
51	Vivek R. Wahurwagh	8956482591		

52 Shiwani SR Dwivedi 8555900516

53 Rinam C Wankhede 8010966529

54 Sanskruti S. Parnebhau 7447613185

Teacher In-charge

55 Manish S. Gunde 9970329857

56 Tejas Solanke 7030750670

No.	StudentName	Subjects	MobileNo	Email	REMARK	Feedback
1	ANJALI RAMKUMAR PALI	BOT, CHE, M/B	7498102109	pali.anjali.4@gmail.com	Yes	Excellent
2	ANUSHRI SHRIKANT WELE	BOT, CHE, M/B	8805417668	anushriwele2000@gmail.com	Yes	Excellent
3	ASTHA ABHAY SAKHARWADE	BOT, CHE, M/B	9405197842	asthasakharwade@gmail.com	Yes	Good
4	AVANTI ASHISH CHAPHEKAR	BOT, CHE, M/B	7875173847	avanti.1011@gmail.com	Yes	Excellent
5	AYUSHI OMPRAKASH SHUKLA	BOT, CHE, M/B	9373668043	ayushishukla28112002@gmail.com	Yes	Good
6	BALRAJ MANGRU WELDA	BOT, CHE, M/B	9420396682	balrajwelda4@gmail.com	Yes	Good
7	BHUMIKA DEVENDRA CHEDGE	BOT, CHE, M/B	9766020042	bhumikachedge@gmail.com	Yes	Excellent
8	KRUSHNALI SANJAYRAO KADU	BOT, CHE, M/B	9175545880	krushnali.sadhu6@gmail.com	Yes	Excellent
9	MADHURA UMESH BHONDWE	BOT, CHE, M/B	8767484914	Madhusabhondwe@gmail.com	Yes	Excellent
10	OJASWINI RAJU BHAGAT	BOT, CHE, M/B	7558367348	wankhedeojaswinibh@gmail.com	Yes	Excellent
11	OM RAJKUMAR SINGH	BOT, CHE, M/B	9923993661	shardabhagat45@gmail.com	Yes	Good
12	POONAM SUNIL CHAURAGADE	BOT, CHE, M/B	8767765121			
13	PRANJALI LAXMIKANT DANDE	BOT, CHE, M/B	9325473318	dandepujanjali6@gmail.com	Yes	Good
14	RINAM CHARANDAS WANKHEDE	BOT, CHE, M/B	8378018528	wankhede.rinamot@gmail.com	Yes	Brilliant
15	ROSHANI MADHAV BAMBAL	BOT, CHE, M/B	9325853408	roshani.2018bb@gmail.com	Yes	Excellent
16	RUPESH WALE WADDE	BOT, CHE, M/B	9405646923	Rupeshwalewadde@gmail.com	Yes	Excellent
17	SAMIKSHA NARENDRA KUNDEKAR	BOT, CHE, M/B	9145253758	samikshakundekar@gmail.com	Yes	Excellent
18	SAMIKSHA RAMCHANDRA CHOUDHARI	BOT, CHE, M/B	7517090406	choudhariesamiksha2@gmail.com	Yes	Excellent
19	SANSKRUTI SANTOSH PANCHBHAVE	BOT, CHE, M/B	7776073261	sanskrutisankhkhare99@gmail.com	Yes	Excellent
20	SAYLI SEVANAND LOKHANDE	BOT, CHE, M/B	9356413804	Sayalilokhande29@gmail.com	Yes	Excellent
21	SHIWANI SHRIRAMAN DWIVEDI	BOT, CHE, M/B	9823797542	shiwani.dwivedi41@gmail.com	Yes	Excellent
22	SHREYANSH SURENDRA NAIKWAR	BOT, CHE, M/B	6268750014	shreyanshnaikwar7@gmail.com	Yes	Excellent
23	SUMAN ASHUTOSH SINGH	BOT, CHE, M/B	7249465307	sumansingh3@gmail.com	Yes	Excellent
24	VISHAKHA GUNWATRAO GAWHADE	BOT, CHE, M/B	7620351270			
25	VIVEK RAMKRUSHNA WAHURWAGH	BOT, CHE, M/B	8956482591	vivekramkrushna19@gmail.com	Yes	Excellent

Total - 49 Students

Microbiology

No.	StudentName	Subjects	MobileNo	Email	Remark	Feedback
1	AARTI BABULAL BISEN	CHE, M/B, ZOO	8888847439	aartibisen129@gmail.com		
2	AISHWARYA ANAND JOSHI	CHE, M/B, ZOO	8956169223	aishwaryajoshi202@gmail.com		
3	ANKITA RAMESH BHOYAR	CHE, M/B, ZOO	8788031173			
4	ARPITA DILIP GAYDHANE	CHE, M/B, ZOO	9923601914	arpitagaydhane@gmail.com		
5	BHARGAVI ABHIJEET SAMBARE	CHE, M/B, ZOO	7709403806	bhargavi.sambare05@gmail.com		
6	BHUSHAN NARESH HARSHE	CHE, M/B, ZOO	7397842243	bhushan.harshe14@gmail.com		
7	ISHA BIRENDRA PRASAD GUPTA	CHE, M/B, ZOO	9373109537	isha1202.gupta@gmail.com		
8	KARISHMA SURESH BANSOD	CHE, M/B, ZOO	7389812507	Karishma.bansod101@gmail.com		
9	LAXMI MUKESHRAO GORLE	CHE, M/B, ZOO	7758058514	laxmigoorle2302@gmail.com		
10	MANALI SATISH SHINDE	CHE, M/B, ZOO	7249637434	manalishinde062@gmail.com		
11	MANISH SUDHAKAR GADE	CHE, M/B, ZOO	9370329857	manishgade1679@gmail.com		
12	NANDINI PURUSHOTTAM POUNIKAR	CHE, M/B, ZOO	9764359642	nandini.pounikar@gmail.com		
13	NANDINI SURESH HADGE	CHE, M/B, ZOO	9370301679	nandini.hadge11@gmail.com		
14	NEHA JITENDRA CHANDRATRE	CHE, M/B, ZOO	9156873792	nehachandratre316@gmail.com		
15	PRANJALI NAGESH GAIKWAD	CHE, M/B, ZOO	9527793663	gaikwadpranjali39@gmail.com		
16	RIDDHI MANISH BHARADWAJ	CHE, M/B, ZOO	7972613061	riddhibharadwaj2002@gmail.com		
17	SADAF PERVEEN AKBAR SHEIKH	CHE, M/B, ZOO	9673410401	Sheikhsadaf93@gmail.com		
18	SANKET KAILASH LODI	CHE, M/B, ZOO	7972085380	SanketLodi23@gmail.com		
19	SHRUTI MAROTI PAWAR	CHE, M/B, ZOO	9527988707	shrutipawar0001@gmail.com		
20	SIDDHA MORESHWAR KATHALE	CHE, M/B, ZOO	8329758490	Siddha.kathale5@gmail.com		
21	SRUSHTI MADAN GAIKWAD	CHE, M/B, ZOO	7385532705	Srushti.gaikwad0555@gmail.com		
22	SUHANI PRALHAD INDURKAR	CHE, M/B, ZOO	9370419064	suhani.indurkar@gmail.com		
23	SURAJ SHYAM YADAV	CHE, M/B, ZOO	8767435158	Surajshyam.yadav22@gmail.com		
24	TANMAY YADAV CHOUDHARI	CHE, M/B, ZOO	8600102341	Tanmaychoudhari@gmail.com		
25	VAIDEHI BANDU KODMALWAR	CHE, M/B, ZOO	8788245910	Vaidhikodmalwar@gmail.com		
26	VAISHNAVI KALIDAS KHARKATE	CHE, M/B, ZOO	9822543972			
27	VISHAL DHANANJAY MISHRA	CHE, M/B, ZOO	9730747159			
28	PRASHANSHA SANJAY LULLA	CHE, M/B, ZOO	8788058109			
29	ADITI RAJA TIPLE	CHE, M/B, ZOO	9699847601			
30	ISHIKA S. THAKRE	CHE, M/B, ZOO	8010907069	ishithakre02@gmail.com		
31	TEJAS .G. SOLANKI	CHE, M/B, ZOO	7030730070	tejasalanki204@gmail.com		

Basic Hematology Quiz

1. Which are the cells Agranulocyte? and Granulocyte?
2. What is the cell size of Large Lymphocyte?
3. What is the cell size of Monocyte?
4. What is the Normal range of MCV?
5. What is the meaning of Anisocytosis?
6. In whole Blood sample results MCH and MCHC is both are high what is the suspected pathological?
7. What is the Size of Normal Platelets?
8. What is the average size of RBC?
9. Which cell is very high absorbance during diff count?
10. What is the lifespan about RBC,WBC,PLATELETS?

HORIBA INDIA TECHNICAL INSTITUTE

Dharampeth M. P. Deo Memorial Science College, Nagpur

Name of the student's:

Date: 19th Oct 2022

(Note: Please read questions properly before writing answer, answer only as requested questions. If required, you can draw picture also.)

1. The different between plasma and serum is that plasma:
 - a. Has more water
 - b. Contain fibrinogen
 - c. Contain low level of sugar
 - d. Does not contain fibrinogen
2. High blood glucose levels (hyperglycemia) may be a sign of the following problems?
 - a. Diabetes,
 - b. Blindness,
 - c. Kidney failure
 - d. All of them
3. Infection control procedures that help to prevent healthcare associated infections include:
 - a. Hand hygiene.
 - b. Always proper use of PPE.
 - c. Cleaning and disinfection of tourniquets, surfaces, and chairs.
 - d. All the above Received today
4. Which test is done for Liver function test?
 - a. Blood Sugar
 - b. Cholesterol
 - c. HDL
 - d. SGPT
5. Which of the following is the most abundant biomolecule on the earth?
 - a. Lipids
 - b. Proteins
 - c. Carbohydrates
 - d. Nucleic acids.

	was happy with content	Presentation skills	Knowledge of presenter
Understanding three part CBC analyser			
Help in running three part analysers			
Understanding and running semiautomated CA 60 chemistry analyser			
Understanding Coagulation			
Experience in the HELO lab			
Soft skill			
Will this program help you decide your future			
Any other comments			

Name
Number



No. DIMTS – Nagpur/RT/2022/2600

Dated: 10 Oct 2022

प्रति,

प्राचार्य धरमपेठ कॉलेज

नागपूर

विषय : बस उपलब्ध करून देण्याबाबत.

संदर्भ : आपले अर्ज दि. 10/10/2022

आपले संदर्भिय पत्राच्या अनुषंगाने कळविण्यात येते की, दि. 18/10/2022 व दि. 19/10/2022 रोजी अंबाझरी रोड नागपूर ते एम.आय.डी.सी.बुट्टीबोरी होरीबा कंपनी सकाळी 08.00 वा.जाणे व रात्री 08:00 वा. येणे करिता म.न.पा. प्रशासकीय आदेशानुसार 2 मिडी बस देण्याचे नियोजन करण्यात आलेले आहे. त्या अनुषंगाने एकूण प्रवास भाडे रु 12000/- श्री सचीन भुते डेपो मॅनेजर, बर्डी डेपो यांचे कडे जमा करण्यात यावे.

Amount Received Rs 12000/- Debit to patwadan
Debit. to Mr. Sachin Bute Sir -



रेसिडेन्ट टीम लिटर
दिल्ली इन्टीग्रेटेडमल्टीमोडल ट्रान्झिट सिस्टीम्स
(नागपूर शहर बस वाहतूक)

[Handwritten signature]
10/10/22

प्रतिलिपी:

1. परिवहन व्यवस्थापक, परिवहन विभाग, म.न.पा., नागपूर.
2. श्री सचीन भुते डेपो मॅनेजर, बर्डी डेपो, नागपूर

3/श्री अनेन नेगले
9423073770
S A [Handwritten signature]

No. DIMTS – Nagpur/RT/2022/

Dated: September 2022

DELHI INTEGRATED MULTI-MODAL TRANSIT SYSTEM LTD.

(A joint venture of the Govt. of NCT of Delhi and 'DFC Foundation')
An ISO 9001:2008, ISO 14001:2004, OHSAS 18001:2007 & ISO 27001 certified company
CIN No. U60232DL2006PLC148406



DHARAMPETH M. P. DEO MEMORIAL SCIENCE COLLEGE, NAGPUR
INTERNAL QUALITY ASSURANCE CELL (IQAC)

Activity Report

Date: 30/10/22

Name of Organizing Department or Committee: Zoology

Name of the activity: Sickle cell screening camp and guest lecture on Sickle cell disease and youth.

Suggested CRITERION point if any: Criteria V

Date of Activity: 18/10/2022

Place of Activity: Late Vinayakrao Phatak Hall

Name of Guest Speaker judge/s or Chief Guest/s if any: Dr. Vinky Rughwani

Title of the Activity: Sickle cell screening camp and guest lecture on Sickle cell disease and youth.

Number of Participants: 150

Name of the Teacher In-charge / Convener: Dr. K. M. Paturkar

Names of other Committee Members / Staff: Dr. K. M. Paturkar students of Zoological Society

OUTCOME of the Activity with respect to mission vision of the institute and or academics:

It helps in finding sickle cell carrier students.

Students get knowledge about importance of sickle cell screening before marriage.

Students get guidance about problems faced by sickle cell disease.

Students get aware about sickle disease.

Activity with newspaper coverage if any: NIL

Activity data save in PC of: Zoology Department/personal laptop



Prof. Pitambar Humane
IQAC Coordinator

Dr. Kirti Paturkar

Name & Signature of Teacher In-charge

Dr. Anillesh Peshwe
Principal

Principal

Dharampeth M. P. Deo Memorial
Science College, NAGPUR,

CO ORDINATOR
INTERNAL QUALITY ASSURANCE CELL
DHARAMPETH, M. P. DEO MEMORIAL &
SCIENCE COLLEGE, NAGPUR



DHARAMPETH M. P. DEO MEMORIAL SCIENCE COLLEGE,
North Ambazari Road, Near Ambazari Lake, Nagpur- 440033

DATA VALIDATION & VERIFICATION (DVV)

Name of the Programme : Sickle cell screening camp
Date of the Programme : 18/10/2022
Name of Chief Guest if any : Dr. Vinky Rughwani
Name of Guest Speaker if any : Dr. Vinky Rughwani

Sr. No.	Name of the Participant	Class/Semester	Mobile Number	E-mail Id	Signature	Remark
1)	Vamika V. Bondar	II nd year (III Sem)	9370673867	bondarvamika2004@gmail.com	Vamika	
2)	Shreya Dhawale	II nd year (III Sem)	8888264004	shreyadhawale124@gmail.com	Shreya	
3)	Vaibhavi Shende	II nd year (III Sem)	8080640782	vaibhavishende97@gmail.com	V.A Shende	
4)	Samiksha Meshram	11 th (D)	9359658591	samikshameshram933@gmail.com	Samiksha	
5)	Nilush Hulke	II nd year (II nd Sem)	9624091652	HulkeNilush@gmail.com	Nilush	
6)	Shreya yadav	11 th (D)	9763748194	Rekha976374@gmail.com	Shreya	
7)	Minakshi Thakre	11 th (D)	9370050972	Thakreminakshi@gmail.com	Minakshi	
8)	Sakshi S Mule	11 th D	7057087101		Sakshi	
9)	Tanusri S Tulankar	11 th (D)	9766919747		Tanusri	
10)	Tannu P. Bhojare	11 th (D)	7378874652		Tannu	
11)	Sakshi S. Pimple	11 th (D)	8669785849		Sakshi	
12)	Ritika Patil	11 th A	8275431798	Manishpatil42@gmail.com	Ritika	
13)	Chanel X. Waghwan	I st year (Sem-I)	7796016894	waghwanchannel@gmail.com	Chanel	
14)	Krutika. Pokale	I st year (Sem I)	3021630341	pokalekrutika96@gmail.com	Krutika	
15)	Dhanashri Neware	I st year (Sem I)	9359809913	dhanashrineware@gmail.com	Dhanashri	
16)	Gauri R. Bhojare	I st year (Sem I)	8668335876	gauribhojare34@gmail.com	Gauri	

Signature of:
Programme In-charge

IQAC Coordinator
IQAC Co-ordinator
Dharampeth M.P. Deo Memorial
Science College, Nagpur-440033

Principal
Principal
Dharampeth M.P. Deo Memorial
Science College, Nagpur.



DHARAMPETH M. P. DEO MEMORIAL SCIENCE COLLEGE,
North Ambazari Road, Near Ambazari Lake, Nagpur- 440033

DATA VALIDATION & VERIFICATION (DVV)

Sr. No.	Name of the Participant	Class/Semester	Mobile Number	E-mail Id	Signature	Remark
17	Riya D. Tonge	11 th (D)	7501331126		Riya Tonge	
18	Rony J. Wahanp	11 th (D)	9309205316		Rony	
19	Tasha Chakhande	11 th (D)	7030896942		Tasha	
20	Diya Dongre	10 th (D)	9806354713		Diya	
21	Harshad Nimje	11 th (A)	9579993367		Harshad	
22	Katika Deshmukh	1st Sem	9699720960	Katika.m.d.20@gmail	Katika	
23	Muskan V. Iulkarni	1st Sem	9156889239		Muskan	
24	Umang Wawthi	1st Sem	9322428500	Umangwawthi@gmail.com	Umang	
25	Khushbu Pali	1 st Sem	8459565214		Khushbu	
26	Ritika Sandhiya	1st sem	9175301653		Ritika	
27	Shrutl Channekar	1st sem	9699823892		Shrutl	
28	Dhanshree Newalkar	3rd Sem	9356516280		Dhanshree	
29	Chakuli Wadkar	3rd sem	90496280		Chakuli	
30	Divya Sh. Shetty	11 th (D)	9503236407		Divya	
31	Divya N. Chaudhari	11 th (D)	7260074960		Divya	
32	Trina Rahangdale	3rd sem	9921776769	trina	Trina	
33	Shrawani Wadhede	3rd Sem	8806636133	shrawanijwarikhedd@gmail	Shrawani	
34	Krishnavi Lakhe	3rd Sem	8669597864		Krishnavi	
35	Jayashree - P. Bobade	11 th D	9935622584		Jayashree	
36	Riya S. Tete	11 th D	8799813520		Riya	
37	Crayari R. Bhalawi	11 th D	9579301221	crayari.bhalawi12@gmail	Crayari	
38	Janvi S. Bhatiya	11 th D	9595627062	Janvi.bhatiya7@gmail	Janvi	

Signature of: 
Programme In-Charge

IQAC Co-ordinator
Dharampeth M. P. Deo Memorial
Science College, Nagpur-440033

Principal
Dharampeth M. P. Deo Memorial
Science College, Nagpur



DHARAMPETH M. P. DEO MEMORIAL SCIENCE COLLEGE,
North Ambazari Road, Near Ambazari Lake, Nagpur- 440033

DATA VALIDATION & VERIFICATION (DVV)

Sr. No.	Name of the Participant	Class/Semester	Mobile Number	E-mail Id	Signature	Remark
1.	Anjali Mishra	II nd year CEM PHE	9325604513	anjali.mishra4956@gmail.com	Anjali	
2.	Harkshata Warkhede	I st year	8263977208	harkshatawarkhede@gmail.com	Harkshata	
3.	Khushi Pali	I st year	8467601224	palikhushi4@gmail.com	Khushi	
4.	Ashlesha Sangale	II nd year	9503998469	AshleshaSangale94@gmail.com	Ashlesha Sangale	
5.	Muskan Yadav	II nd year	9579492617	Muskanyadav1225@gmail.com	Muskan	
6.	Devashish Bisen	II nd year	1767861231	DevashishBisen31@gmail.com	Devashish Bisen	
7.	Pranjali Meshram	I st year	7888080054	PranjaliMeshram85@gmail.com	P. Meshram	
8.	Neha L. Wanjari	I st year	9373332266	nehawanjari333@gmail.com	Neha	
9.	Kiran K. Ghughuskar	I st year	9021231607	ghughuskarkiran@gmail.com	Kiran	
10.	Nishu S. Kocankar	I st year	9890996645	NishuS.Kocankar332@gmail.com	Nishu	
11.	Vaidhree B. Gangal	I st year	950967278	gangalvaidhree@gmail.com	Vaidhree	
12.	Shivam D. Kushwara	XI std.	9373885814	Shivkushd19@gmail.com	Shivam	
13.	Rohit H. Prasad	XI std.	9766537148	RohitPrasadp6@gmail.com	Rohit	
14.	Tanu A. Singh	I st year	8806255808	tanusingh63499@gmail.com	Tanu	
15.	Aakansha Y. Jaiswal	I st year	8010923662	aakansha2006@gmail.com	Aakansha	
16.	Khushi Gajbhiye	I st year	7798233165	gajbhiye.khushi8@gmail.com	Khushi	
✓ 17.	Nandini Lakshmale	I st year 11 th D.	8421617268	nandini11@gmail.com	Nandini	
18.	Twinkle Rongani	11 th class	8308066649	TwinkleRongani62@gmail.com	Twinkle	
19.]	Vaishali Bisen	I st year	72493845360	VaishaliBisen@gmail.com	Vaishali	
20.]	Aditi Sukhdeve	XI th	8080181885	aditisukhdeve@gmail.com	Aditi	
21.]	Amisha Aokara	I st year	766559171	Aokaramisha700@gmail.com	Amisha	
22.]	Qisha Kature	IV sem	9021541048	Tishakature@gmail.com	Qisha	

Signature of:
Programme In-charge

IQAC Coordinator

IQAC Co-ordinator

Dharampeth M.P. Deo Memorial
Science College, Nagpur-440033

Principal

Principal

Dharampeth M.P. Deo Memorial
Science College, Nagpur.





DHARAMPETH M. P. DEO MEMORIAL SCIENCE COLLEGE,
North Ambazari Road, Near Ambazari Lake, Nagpur- 440033

DATA VALIDATION & VERIFICATION (DVV)

Sr. No.	Name of the Participant	Class/Semester	Mobile Number	E-mail Id	Signature	Remark
1	Priya Manoj Gupta	11 th (C)	8588472213		P. Gupta	
2	Akanksha G. Saurav	11 th (C)	7499574913		(A)	
3	Sunita D. Tembhare	11 th (D)	7058132802		Sunita.	
4	Shubhangi D. Kalprut	11 th (D)	9552775383		shubhangir	
5	Arjuni A. Singh	11 th (C)	8669106102		(A)	
6	Sahani S. Bhanu	11 th (C)	9222050685		Bahani	
7	Divya A. Narasimhan	11 th (D)	9309331812		Divya	
8	Nisha V. Pandey	B.S.C 1 st year	8605231390	Abhishek.86531390@gmail.com	Nisha	
9	Nisha N. Waghade	11 th (D)	4499030515		Nisha	
10	Kritika R. Rajwade	11 (D)	7822081834		(K)	
11	Priya B. Shahane	1 st year (B.Sc)	8010764549	priya19012004shahane@gmail.com	Priya	
12	Yashany Pandey	1 st year	9156035297		Yashany	
13	Ghanashree U. Dhamane	1 st year (B.Sc)	8459807067	ghanashree@gmail.com	Ghanashree	
14	Nutan Manikam	11 th (D)	7058693708	nutanmanikam125	Nutan	
15	Manali Kalamkar	11 th (D)	8279824574		(M)	
16	Sejal A. Bhange	11 th (D)	8208929715		Sejal	
17	Khushi S. Waghmare	11 th (D)	7038917381		Khushi	
18	Yashashree V. Grandham	11 th (D)	9260346993		Grandham	
19	Vaishnavi N. Torje	BSC sem I	8421657443	Vaishnavi2004@gmail.com	Vaishnavi	
20	Tanvi T. Phansale	BSC sem I	8459543857	tanviphansale76@gmail.com	Tanvi	
21	Khushi K. Rewade	BSC sem I	9588445994	khushikrewade@gmail.com	Khushi	

Signature of: 
Programme In-charge

IQAC Co-ordinator
Dharampeth M.P. Deo Memorial
Science College, Nagpur-440033

Principal
Dharampeth M.P. Deo Memorial
Science College, Nagpur.



DHARAMPETH M. P. DEO MEMORIAL SCIENCE COLLEGE,
North Ambazari Road, Near Ambazari Lake, Nagpur-440033

DATA VALIDATION & VERIFICATION (DVV)

Sr. No.	Name of the Participant	Class/Semester	Mobile Number	E-mail Id	Signature	Remark
1)	Sitendra Kamale	11 th	9617168983	kawde.singenda		
2)	Punesh Datto	1 st year	9421559669			
3)	Pritam Kulkode	1 st year	7499317229	Pritamkulkode@gmail.com		
4)	Raj Meshram	1 st year	9523927021	rajmeshram1603@gmail.com		
5)	Amita. Dalkar.	2 nd yr	9028915776	dalkaraditya@gmail.com		
6)	Nikhil Rout	2 nd yr	9022680159	routn651@gmail.com		
7)	Shubham Singh	3 rd year	9370244760	Shubhamsingh@gmail.com		
8)	Lucky A Vishwakarma	1 st year	9579660186	lvishwakarma290@gmail.com		
9)	Harish Pal	11 th	8484817197			
10)	Satyam S. Mishra	2 nd year	7798430275	satyammishra2003@gmail.com		Satyam.
11)	Sejal D. Kolhe	1 st year	8483045985	kolhesejal04@gmail.com		Kolhe
12)	Shamwani Umair	1 st year	9284249534	shamwani1912@gmail.com		
13)	Arijati Thakore	1 st year	7066554321	Arijathakore@gmail.com		Thakore
14)	Komalika choudhari	1 st year	9322033866	komalikachoudhari@gmail.com		
15)	Mithilesh kshirsagar	11 th	9699481098	Mithileshkshirsagar6@gmail.com		mk
16)	Akash Nabik	11 th	7798125870	akashnabik0@gmail.com		
17)	Jurgesh R Chauhan	11 th	8624890264	chauhanjurgesh16@gmail.com		
18)	Aryan P. Chaudhari	11 th	9960083475	aryanchaudhari764@gmail.com		
19)	Aryan B. Desai	11 th	7822926631	aryandesai0611@gmail.com		
20)	Roohani G. Nabik	11 th	7030024153			
21)	Deepik. Tiwari	11 th	9175784046			
22)	Jarvis Dongre	11 th	7276107960	JarvisDongre@gmail.com		

Signature of:
Programme In-charge

IQAC Coordinator

IQAC Co-ordinator
Dharampeth M.P. Deo Memorial
Science College, Nagpur-440033

Principal

Dharampeth M.P. Deo Memorial
Science College, Nagpur.



DHARAMPETH M. P. DEO MEMORIAL SCIENCE COLLEGE,
North Ambazari Road, Near Ambazari Lake, Nagpur- 440033

DATA VALIDATION & VERIFICATION (DVV)

Sr. No.	Name of the Participant	Class/Semester	Mobile Number	E-mail Id	Signature	Remark
1	Tithi . Afagia	11 th	9175143465	afagiaTithi@uvmu.ac.in	Tithi	
2	Tanvi . Ambule	11 th	8010292844		Tanvi	
3	Priyanka . G. Das	11 th	9529285034	pdas18515@gmail.com	Priyanka	
4	Achal Marstolhe	11 th	9690579841		Achal	
5	Gayatri Meshram	11 th	9673444085		Gayatri	
6	Supriya Bhaskar	11 th	9021895503		Supriya	
7	Sakshi Bhaskar	11 th	9021895503		Sakshi	
8	Pooja Thakre	I st Year	8262969713	thakrepooja733@gmail.com	Pooja	
9	Tejas Chelmalwan	I st Year	9604662119	tejaschelmalwan@gmail.com	Tejas	
10	Nihal V. Meshram	I st Year	8767792960	nihalmeshram75@gmail.com	Nihal	
11	Pritam & Ratna	I st Year	8010793204	pritamratna65@gmail.com	Pritam	
12	Nikhil . R. Kuruse	I st year	8999040961	kurusenikhil1@gmail.com	Nikhil	
13	Anay . B. Borke	I st year	9155401246	anayborke42@gmail.com	Anay	
14	Ruchi . Tripathi	I st year	8080776693	ruchitripathi130@gmail.com	Ruchi	
15	Chiranjiv . Gajbhaye	I st year	7196403357	gajbhaye17@gmail.com	Chiranjiv	
16	Abhishek Sharma	11 th	7498740695		Abhishek	
17	Sungam Bisd	11 th	9175899072		Sungam	
18	Sumanadi . V. Meshram	11 th	9503651928	sumanadimeshram8@gmail.com	Sumanadi	
19	Jeet . Pardihi	I st Year	7020215431	jeet.pardihi@gmail.com	Jeet	
20	Abhay . Tembhare	I st Year	8975363145		Abhay	
21	Samyak . Hadke	I st Year	7020171506	samyakhadke4567@gmail.com	Samyak	
22	Anshul . Kinnapure	I st Year	3284067169	anshulkinnapure696@gmail.com	Anshul	

Signature of:
Programme In-charge

IQAC Coordinator
Dharampeth M. P. Deo Memorial
Science College, Nagpur-440033

Principal
Dharampeth M. P. Deo Memorial
Science College, Nagpur.



DHARAMPETH M. P. DEO MEMORIAL SCIENCE COLLEGE,
North Ambazari Road, Near Ambazari Lake, Nagpur-440033

DATA VALIDATION & VERIFICATION (DVV)

Sr. No.	Name of the Participant	Class/Semester	Mobile Number	E-mail Id	Signature	Remark
23	Jasraj Bhalwal	Sem III	9376820325	jasrajbhalwal47@gmail.com		
24	Hitesh Kaware	Sem III	7058427112	hitesh.kaware73@gmail.com		
25	Rushikesh Sane	12 th	8767000652	sanesanjay26@gmail.com		
26	Twinkel Lokhande	2 nd year III	8149176609	twinkalokhande@gmail.com		
27	Nishant Jambhale	1 st	8237743521	nishantjambhale		
28	Pooja Itankar	2 nd year sem III	9156973252	poojaitankar957@gmail.com		
29	Wishnavi Nandpume	2 nd year sem III	9322439316	wishnavi.nandpume@gmail.com		
30	Vishal Achare	1 st	7038446716	Tushangm@gmail.com		
31	Aarman Melangale	1 st	9637739595	sauabhmelangale@gmail.com		
32	Vaishnavi nandpume	2 nd				
33	Niket Thakre	2 nd year	9972283409	Niketthakre60@gmail.com		
34	Rupesh Bhokre	2 nd year	8492496678	RupeshBhokre11@gmail.com		
35	Jagruhi Warkar	2 nd (sem 3)	7447366023	jagruhiwarkar9@gmail.com		
36	Sakshi Meshram	2 nd (sem 3)	9145355732	sakshimeshram20@gmail.com		
37	Juhi Chaudhari	2 nd (sem 3)	8669248944	chaudharijuhi20@gmail.com		
38	Mansi Mate	2 nd (sem 3)	8468891807	mansi19182@gmail.com		
39	Nilambari Ganvir	XI	7058364604	Nilambariganvir@gmail.com		
40	Shruti Bhingode	XI	7498127185	shrutibhingode01@gmail.com		
41	Manthan Todase	1 st year	8080874301	manthan.todase696@gmail.com		
42	Riya Raybhar	1 st year	8600256951	riyareyibhar18@gmail.com		
43	Pranali Chawhare	1 st year	9699654562	pranali.chawhare69@gmail.com		
44	Pratiksha Meshram	1 st year	8459070338	meshrampratiksha@gmail.com		

Signature of:
Programme In-Charge

IQAC Coordinator
Dharampeth M. P. Deo Memorial
Science College, Nagpur-440033.

Principal
Dharampeth M.P. Deo Memorial
Science College, Nagpur.



**DHARAMPETH M. P. DEO MEMORIAL SCIENCE COLLEGE, NAGPUR
ROTARACT CLUB OF DMPDSVM**

Activity Report

Date: 30 /10/2022

Name of Organizing Department or Committee: ROTARACT CLUB OF DMPDSVM

Name of the activity: Food Aura (World Food Day)

Suggested CRITERION point if any: Criterion III & Criterion V

Date of Activity: 18th October 2022

Place of Activity: In collaboration with Home Science Department

Name of Guest Speaker/s or Judge/s or Chief Guest/s if any: NIL

Title of the Activity: Food Fest

Number of Participants: 252

Name of the Teacher In-charge / Convener: Dr.Mrs.Shraddha Deshpande

Names of other Committee Members / Staff: Rotaract Club Members

OUTCOME of the Activity with respect to mission vision of the institute and or academics:

This day generates awareness globally for those who suffer from hunger and ensures the need for food security and nutritious diets for all. The main focus of this day is that food is a basic and fundamental human right. The club members decided to have a food fest and generate funds to be used for food distribution.

Activity with newspaper coverage if any: NIL

Activity data save in PC of: Department of English

Prof. Pitambar Humane
IQAC Coordinator

CO ORDINATOR
INTERNAL QUALITY ASSURANCE CELL
DHARAMPETH, M. P. DEO MEMORIAL &
SCIENCE COLLEGE, NAGPUR

Dr. Mrs. Shraddha Deshpande
Teacher In-charge

Dr. Akhilesh Peshwe
Principal
Principal
Dharampeth M.P. Deo Memorial
Science College, Nagpur.



DHARAMPETH M.P.DEO MEMORIAL SCIENCE COLLEGE, NAGPUR

ROTARACT CLUB 22-23

World Food Day: Food Aura

18 October 2022

Rotary.org Link:

Instagram Link



Rotaract Club of Dharampeth M.P. Deo Memorial Science College, Nagpur And Department of Home Science Together Presents..

Food Aura

WE ARE ORGANIZING A FOOD FAIR ON THE OCCASION OF WORLD FOOD DAY THAT IS ON 16TH OCTOBER.

You are kindly requested to register yourself (group of 3-4 students) for the same.

Theme of the fair is **COLOURFUL FOOD** (like Dishes, Jotels, pastels in which different colors are clearly visible).

You can prepare the food at your home by adding natural coloring (example: turmeric, paprika).

All the students must themselves are encouraged not to bring their own bottled sugar, various kinds of food from the fair which will be available at minimal price.

Registration fees - 200 rs (It will be provided you with staff for setting up your food table and will be provided in the evening and what ever you'll be earning by selling food will all be yours.)

III

VENUE-COLLEGE CAMPUS
DATE - 18-10-2022
TIME :- 8:00-3:00 PM

Online payment: Student Baza. (9850488796)

FOR ANY QUERY CONTACT:-
RAJAL SHYAM:- 988884222
SANCHITA PATIL:- 988078074

Teacher In-charge
Sanchita Shetye
Sanchita Patil



DHARAMPETH M. P. DEO MEMORIAL SCIENCE COLLEGE,
North Ambazari Road, Near Ambazari Lake, Nagpur- 440033

DATA VALIDATION & VERIFICATION (DVV)

Winners Setate

1st - Potachi and group
2nd - Sugata and group.
3rd - Vedant & Harshad

Name of the Programme : Food Pwca (World Food Day).
Date of the Programme : 18th October 2022
Name of Chief Guest if any : Mrs. Sidiya Siddique
Name of Guest Speaker if any : -

Sr. No.	Name of the Participant	Mobile Number	E-mail Id	Signature
1	Kawita Mishra	9657199261	Km7832839@gmail.com	<u>Rishu</u>
2	Kajal Prasad	7410763133	prasadkajal2004@ymail.com	<u>KPrasad</u>
3)	Mansi Budale	7796308467	Mansibudale@gmail.com	<u>Mansibudale</u>
4)	Nidhi K. Misar	8805917268	NidhiMisar2003@gmail.com	<u>Nidhi</u>
5)	Jitendra J. Ratone.	9657459925	Jitendrasutar@gmail.com	<u>Jitendra</u>
6)	Aditya Mishra	7218484184	adityamishra3933@gmail.com	<u>Aditya</u>
7)	Apurva S. Verulkar	9623613911	apurva.verulkar@gmail.com	<u>Ashwini</u>
8)	Divya K. Hanote	8605422901	divyahanote406@gmail.com	<u>Divya</u>
9)	Nikita I Kalle	9061324988	kallenikita54@gmail.com	<u>Nikita</u>
10)	Sejal R. Lakshmpal	9028851568	sejalakshampal@gmail.com	<u>Sh.</u>

Signature of:

Siddique
Programme In-charge

[Signature]
IQAC Coordinator
CO ORDINATOR
INTERNAL QUALITY ASSURANCE CELL
DHARAMPETH, M. P. DEO MEMORIAL &
SCIENCE COLLEGE, NAGPUR

[Signature]
Principal
Principal
Dharampeth M.P. Deo Memorial
Science College, Nagpur.



DHARAMPETH M. P. DEO MEMORIAL SCIENCE COLLEGE,
North Ambazari Road, Near Ambazari Lake, Nagpur- 440033

DATA VALIDATION & VERIFICATION (DVV)

PANI PURI

1	Siddharth G. Hirkane	9579092931	hirkane.siddharth.1234@gmail.com	Bhute
2	Jyoti Chavma	8669136380	jyoti.2390@gmail.com	T. Sharma
3	Sania Raza	8975726700	midhatravis@gmail.com	Raza
4	Blathi Shermoo	9075915334	de.	
5	Dr. Kirti Patilkar	9850301939		
6	Dr. Anshu Navale			
7	Mrs. Priyanka R. Ganekar	9890211585	joshi.priyanka@gmail.com	Ra
8	Prof. Pitambar M. Mura	9970468635		Thur
9	A. Hemin Garkwad	9423102180	hp.garkwad@rediff.com	
10	Zoology Department Zoology Department 2			
11	Priyankhi Singh	7219259020	priyankhisingh1504@gmail.com	Singh
12	Anushka S. Das	7058933157	aid04092001@gmail.com	Das
13	Akanksha R. Yeluge	8767935524	akankshayeluge@gmail.com	Akanksha
14	Swraj Shande	9356666487		
15	Ishwan U. Suryawanshi	8087317297	swrajwanshi@rediff.com	Ishwan

Signature of:

Programme In-charge

COORDINATOR

INTERNAL QUALITY ASSURANCE CELL
DHARAMPETH, M. P. DEO MEMORIAL &
SCIENCE COLLEGE, NAGPUR

Principal

Dharampeth M.P. Deo Memorial
Science College, Nagpur.



DHARAMPETH M. P. DEO MEMORIAL SCIENCE COLLEGE,
North Ambazari Road, Near Ambazari Lake, Nagpur- 440033

DATA VALIDATION & VERIFICATION (DVV)

16	Surbhali Patil	7887516629	surbhaliPatil@gmail.com	gandhi
17	Muskan yadav	9579492617	muskenyada@gmail.com	Myadav
18	Aakansha maistral	8010923662	aakanyogi2009@gmail.com	Aakansha
19	Khushi Rewade	9588445994	khushirewade@gmail.com	Rewade
20	Priyanka Das	9529285034	pdas18515@gmail.com	Das
21	Trupti Ambule	8010292844		Trupti
22	Achal Maraskolke	7058365609		A MARASKOLKE
23	Nilambazi Ganvir			Nilambazi
24	Simran Shimale	7666330683		Shimale
25	Shikha Deshpande	9130091540		Shikha
26	Mrs Manju Deshpande	9890064284		M
27	Jankvi Jaje	7385060871		Jankvi
28	Varsha Turkar	937850950		Turkar
29	Atmarv. Gishre	9404413055		Gishre
30	Renuka Kande	7719951401		Kande

Signature of:

Programme In-charge

CO ORDINATOR
INTERNAL QUALITY ASSURANCE CELL
DHARAMPETH, M. P. DEO MEMORIAL &
SCIENCE COLLEGE, NAGPUR

Principal
Dharampeth M.P. Deo Memorial
Science College, Nagpur.



DHARAMPETH M. P. DEO MEMORIAL SCIENCE COLLEGE,
North Ambazari Road, Near Ambazari Lake, Nagpur- 440033

DATA VALIDATION & VERIFICATION (DVV)

PANI PURI

31	Archana Ashilkar			
32	Mrs. Swale Joshi			John
33	Ma'am			
34	Arpita Jute			Alas
35	Mrs. Shradha Grewal			S
36	Mrs. Smriti Narale			S
37	Komal Kumbhara	7620314869		Romel
38	Neha Bankar	8055477553		Ramkumar
39	Nirjara Kapse	8263960077		Nirjara
40	Nupur Sharma	9322049259		Ashwini
41	Hareh Kadape	7928346210		Raj
42	Gayatri Varma	9763287531		Gayatri
43	Mahima Wankhede			Mahima
44	Preetna Chaudhari	7620384149		Preetna
45	Sakshi Chakunde	7843018801		Sakshi

Signature of:

Programme In-charge

CO ORDINATOR
INTERNAL QUALITY ASSURANCE CELL
DHARAMPETH, M. P. DEO MEMORIAL &
SCIENCE COLLEGE, NAGPUR

Principal
Dharampeth M.P. Deo Memorial
Science College, Nagpur.



Rotaract club
Kwikkure Bhul

DHARAMPETH M. P. DEO MEMORIAL SCIENCE COLLEGE,
North Ambazari Road, Near Ambazari Lake, Nagpur- 440033

DATA VALIDATION & VERIFICATION (DVV)

46)	Divya Gawande	7385589316	divyagawande125@gmail.com	
47)	Payashree Shoke	9420566010		
48)	Prof. Pitambar Humane	9770468035		
49)	U. Pr. P. W. Ambekar	7116899118		
50)	Dr. N. P. Gaikwad	9623103560		
51)	Ritika Sondhiya	917559165		
52)	Muskan Kekkarai	9156887239		
53)	Gayatri Varma	9763287531		
54)	Jarvi Bhatiya	7248959526		
55)	Nitjara Tapse	8263960077		
56)	Vaishavi Bopadure			
57)	Manya M. Deshpande	9890264284		
58)	Vivek S. Sah X2	9923963071		
59)	Manasi. Wansat	8624005985		
60)	Anjali Shukla	9373105884		

Signature of:

Programme In-charge

ICAAC COORDINATOR
INTERNAL QUALITY ASSURANCE CELL
DHARAMPETH, M. P. DEO MEMORIAL &
SCIENCE COLLEGE, NAGPUR

Principal
Dharampeth M.P. Deo Memorial
Science College, Nagpur.



Rotaract club
Kuskuwa Bhul

DHARAMPETH M. P. DEO MEMORIAL SCIENCE COLLEGE,
North Ambazari Road, Near Ambazari Lake, Nagpur- 440033

DATA VALIDATION & VERIFICATION (DVV)

61)	Bhavana Yumdasani	8888437303	bhavanyagumdasani@gmail.com	Bhavana
62)	Aditi Vaidya	9075714591	aditivaidya619@gmail.com	Ad
63)	Shalu pardihi	8329115380	shalupardihi@gmail.com	
64)	Shubhangi Nishad	9515534076	shubhnishad151@gmail.com	Shubangi
65)	Tajashree P. Bobade	779624175	Tajashree09@gmail.com	Tajashree
66)	Rohini Gajbhaye	9766782254	RohiniGajbhaye10@gmail.com	RohiniGajbhaye
67)	Samruddhi dengade	9021403782		Sam
68)	Kalyani gatade	7775074317	KalyaniGatade62@gmail.com	Kalyani
69)	Chetan bopche	9172484628	ChetanBopche27@gmail.com	Chetan
70)	Priyanka gosankar	9890211585	joshi10priyankaga@gmail.com	Priyanka
71)	Dr. Snehal Katala	9890336139	SnehalKatala16@gmail.com	Snehal
72)	Mrs Shobha Zalka	9307482885	ZalkaShobha5@gmail.com	Shobha
73)	Shraddha ozarkar	8087502147	shraddha_ozarkar11@gmail.com	Shraddha
74)	Pranika Lamole	7719954101	pranikalamole20@gmail.com	Pranika
75)	Aditi Lute	7820812323		

Signature of:

Programme In-charge

CO ORDINATOR
INTERNAL QUALITY ASSURANCE CELL
DHARAMPETH, M. P. DEO MEMORIAL &
SCIENCE COLLEGE, NAGPUR

Principal
Dharampeth M.P. Deo Memorial
Science College, Nagpur.

Chana chosre



DHARAMPETH M. P. DEO MEMORIAL SCIENCE COLLEGE,
North Ambazari Road, Near Ambazari Lake, Nagpur- 440033

DATA VALIDATION & VERIFICATION (DVV)

1)	Mayuri G Mali	9689001714	mayurimali@gmail.com	Smali
2)	Sakshi Thorat	8177911360	sakshithorat620@gmail.com	Sakshi
3)	Ananya Meghra	9284834439	ananyaMeghra@gmail.com	Ananya
4)	Mohima Wankhede	7821883251	mohimawankhede@gmail.com	Mohima
5)	Vaishnavi Bahadure	9284679244	vaishnavibahadure30@gmail.com	Vaishnavi
6)	Rupali Sahare	9		R.S.
7)	Dr shraddha Pande	9637793898	smbansal@gmail.com	S.P.
8)	Ishu Namade	7028494761	ishunamade31@gmail.com	Ishu
9)	Ananya R. Motghare	4219218355	ananyamotghare1802@gmail.com	Ananya
10)	Raj Mesheam			Raj
11)	tanmay bhute	7		T.B.
12)	Prof. Pitambhar Humane	9970468635		P.H.
13)	Gajanan R. Mahapatra	9662504779	Very Good	G.R.
14)	Tejas chelamelwan			T.C.

Signature of:

Gajeshpande
Programme In-charge

IQAC COORDINATOR
INTERNAL QUALITY ASSURANCE OFFICER
DHARAMPETH, M. P. DEO MEMORIAL
SCIENCE COLLEGE, NAGPUR

Principal
Dharampeth M.P. Deo Memorial
Science College, Nagpur.



DHARAMPETH M. P. DEO MEMORIAL SCIENCE COLLEGE,
North Ambazari Road, Near Ambazari Lake, Nagpur- 440033

DATA VALIDATION & VERIFICATION (DVV)

15)	Nupur . M. Shirsone	9822042259	nupurshirsone20@gmail	
16)	Aasmin . A. Sheikh	8668323568	aasmin094@gmail	asheikh
17)	Chhaya . Patil			Patil
18)	Nikhil Edlabadkar	9923651899		
19)				
20)				
21)				
22)				
23)				
24)				
25)				
26)				
27)				
28)				
30)				

Signature of:

Programme In-charge

CO ORDINATOR
INTERNATIONAL COORDINATION CELL
DHARAMPETH, M. P. DEO MEMORIAL &
SCIENCE COLLEGE, NAGPUR

Principal
Dharampeth M.P. Deo Memorial
Science College, Nagpur.



DHARAMPETH M. P. DEO MEMORIAL SCIENCE COLLEGE,
North Ambazari Road, Near Ambazari Lake, Nagpur- 440033

DATA VALIDATION & VERIFICATION (DVV)

31)	Pallavi B. Katre	8459277408	<u>Pallavi</u>	
32)	Poonali Ahongadkar	9309079427	<u>Poonali</u>	
33)	Sujata Kawade	9175451202	<u>Sujata</u>	
34)	Nupur Sharma	9322042259	<u>Nupur</u>	
35)	Muskan	.	<u>Muskan</u>	
36)	Vaishnavi Suman	9156916355	<u>Vaishnavi</u>	
37)	Samrudhi		<u>Samrudhi</u>	
38)	Kajal		<u>Kajal</u>	
39)	Dr. Pooja Khadewal		<u>Dr. Pooja</u>	
40)	Ritika	9175581655	<u>Ritika</u>	
41)	Umang	9322428500	<u>Umang</u>	
42)	Mahi	9960629566	<u>Mahi</u>	
43)	Sadhna Pardhi		<u>Sadhna</u>	
44)	Ruma Kapre	9423110272	<u>Ruma</u>	

Signature of:

SADASH PANDHAR
Programme In-charge

[Signature]

CO ORDINATOR
INTERNAL QUALITY ASSURANCE CELL
DHARAMPETH, M. P. DEO MEMORIAL &
SCIENCE COLLEGE, NAGPUR

[Signature]

Principal
Dharampeth M.P. Deo Memorial
Science College, Nagpur.



DHARAMPETH M. P. DEO MEMORIAL SCIENCE COLLEGE,
North Ambazari Road, Near Ambazari Lake, Nagpur- 440033

DATA VALIDATION & VERIFICATION (DVV)

Makela ←

45)	Khushbu Pali	8459565214	
48)	Kattika Deshmukh	9699720960	
47)	Kishor Waghmare	8446262789	
48)	Tushal - R. Achal	9075995617	
49)	Ruma R. Kapre	9423110272	
50)	Shradha Deshpande	9860042850	
51)	Ankur	7249884620	
52)	Tushar D. Bisne	9764827755	
53)	& Nilambari Gyanvir		
54)	Rohini Waghbiye	9766782254	
55)	Ekwan Suryawanshi		
56)	Tushar H. Kashyap	7447565340	
57)	Wagh (7/2)	9767256188	
58)	Sa SA. Jawade	9404	
59)			

Signature of:

Programme In-charge

ISO COORDINATOR

INTERNAL QUALITY ASSURANCE CELL
DHARAMPETH, M. P. DEO MEMORIAL &
SCIENCE COLLEGE, NAGPUR.

Principal

Dharampeth M.P. Deo Memorial
Science College, Nagpur.



DHARAMPETH M. P. DEO MEMORIAL SCIENCE COLLEGE,
North Ambazari Road, Near Ambazari Lake, Nagpur- 440033

BHEL

DATA VALIDATION & VERIFICATION (DVV)

60)	Prema Chaudhari	7620384149	premadishchaudhari07@gmail.com	Prema Chaudhari
61)	SAKSHI CHAKUNDE	7843018801	sakshichakunde@gmail.com	Schakunde
62)	Anshikha Jarwarkar	9021391207	anshikhajarwarkar@gmail.com	Anshikha
63)	Hemlata Verma	4517058379	varmashemlata957@gmail.com	Hemlata Verma
64)	Janvi A. Kesorikar	7888116270	Janvikorankar@gmail.com	Janvi
65)	Pratiksha Chaudhari	7407317699	PratikshaChaudhari@gmail.com	Pratiksha Chaudhari
66)	Ishwar Sargawankar	8887317297	Sargawankarishwar123@gmail.com	Ishwar
67)	Isha Nemate	7028494761	Ishanemate.79@gmail.com	Ishamate
68)	Kashish Dhote	9322034733	dhotekashish1@gmail.com	K. Dhote
69)	Janvi Bhatiya	7350631206	Bhagyeshhucekar@gmail.com	Bhagyesh
70)	Janvi Bhatiya	7248954526	janvibhatiyu7@gmail.com	Janvi
71)	Bhakti Shrinivas	9075915534		Bhakti
72)	Sakhal Sapke	9730890750		Sakhal
73)	Sagar Pimplikar	8766419049		Sagar Pimplikar
74)	Nilambari Ganvir			Nilambari

Signature of:

Programme In-charge

IQAC Coordinator

CO ORDINATOR
INTERNAL QUALITY ASSURANCE CELL
DHARAMPETH, M. P. DEO MEMORIAL &
SCIENCE COLLEGE, NAGPUR

Principal
Dharampeth M. P. Deo Memorial
Science College, Nagpur.



DHARAMPETH M. P. DEO MEMORIAL SCIENCE COLLEGE,
North Ambazari Road, Near Ambazari Lake, Nagpur- 440033

BHEL

DATA VALIDATION & VERIFICATION (DVV)

75)	Khushi Waghade	91565 20783	khushidussephade@gmail.com	Khushi Waghade
76)	Ketan Bhujar	9657957288	ketanbhujar@gmail.com	Ketan
77)	S.K. Hamparale			
78)	N.V. Bhalerao			
79)	U.A. Wagh			
80)	R.K. Sahasr			
81)	Nishant Jamnani	823 7743521	nishant.jamnani@gmail.com	Nishant
82)	Dr. Snehal Natakale	9890336139	snehal.natakale@gmail.com	Snehal
83)	Dr. Naisvalli Meethran	7753907262	naisvalli296@gmail.com	Naisvalli
84)	Siddhi Jiwari	8087143696	siddhijiwari0721@gmail.com	Siddhi
85)	Paripna Kashyap	7038962494		
86)	Kumal Dighe	9010274303	kumal	Kumal
87)	Sakshi Kanade	8329760853		Sakshi
88)	Mrs. Vibha	9420296680	scenmk14@gmail.com	Mrs. Vibha
89)	Dr. Dnyaneshwar Patil			

Signature of:

Programme In-charge

COORDINATOR
INTERNAL QUALITY ASSURANCE CELL
DHARAMPETH, M. P. DEO MEMORIAL &
SCIENCE COLLEGE, NAGPUR

Principal
Dharampeth M.P. Deo Memorial
Science College, Nagpur.



DHARAMPETH M. P. DEO MEMORIAL SCIENCE COLLEGE,
North Ambazari Road, Near Ambazari Lake, Nagpur- 440033

DATA VALIDATION & VERIFICATION (DVV)

90)			
91)	Nisha Pandey	8605231330	Pandey
92)	Yachana Pandey	9156035297	Pandey
93)	Kashish Dhoke	9322094139	K. Dhoke
94)	Bhagyashri Dhoke	8669997428	B. Dhoke
95)	Gauri Shindekar	982280997	G. Shindekar
96)	Nutan Surjuse	8805570279	Surjuse
97)	Damini Patre	8208255685	Patre
98)	Bhagyashree	8766925275	Bhakar
99)	Riya Rahut	9519688956	Rahut
100)	Harme Sid	9970468635	Sid
101)	Nitin Gaikward		
102)	Prashant Ambekar		
7- 103)	Mrs. Usha Wagh		Wagh
104)	Ishita		Ishita

Signature of:

Suresh Pandey
Programme In-charge

[Signature]
IQAC Coordinator
CO ORDINATOR

INTERNAL QUALITY ASSURANCE CELL
DHARAMPETH, M. P. DEO MEMORIAL &
SCIENCE COLLEGE, NAGPUR

[Signature]
Principal
Dharampeth M.P. Deo Memorial
Science College, Nagpur.



DHARAMPETH M. P. DEO MEMORIAL SCIENCE COLLEGE,
North Ambazari Road, Near Ambazari Lake, Nagpur- 440033

DATA VALIDATION & VERIFICATION (DVV)

1	Harsh Kodape			
2	Sahil Singh			
3	Krushali Jichkar			
4	Ani Rai			
5	Khushi Chaudhari			
6	Shruti Bhingade			<i>[Signature]</i>
7	Raj Meshram			
8	Vanshika Thodake			
9	Punesham Parasha			
10	Yamini K. Nagase			
11	Anjali V. Farsankar			
12	Aasmin K. Sinekhi			
13	Ananya R. Motghare			<i>[Signature]</i>
14	Tushar D. Bishu			<i>[Signature]</i>
15	Shreelha Deshpande Vinay Singh			

Signature of:

[Signature]
Programme In-charge

[Signature]
CO-ORDINATOR
INTERNAL QUALITY ASSURANCE CELL
DHARAMPETH M. P. DEO MEMORIAL &
SCIENCE COLLEGE, NAGPUR

[Signature]
Principal
Dharampeth M.P. Deo Memorial
Science College, Nagpur.



DHARAMPETH M. P. DEO MEMORIAL SCIENCE COLLEGE,
North Ambazari Road, Near Ambazari Lake, Nagpur- 440033

DATA VALIDATION & VERIFICATION (DVV)

16	Siddhi Jiwani	8087143696	siddhijiwani0721@gmail.com	<i>Siddhi Jiwani</i>
17	Mahi Thaware	9960629566	matthawaromahi7@gmail.com	<i>Mahi</i>
18	Brajwal Bhoyar	8010434634	Brajwal738@gmail.com	<i>Brajwal</i>
19	Muskan Kulkarni	9156789239	muskan.kulkarni35@gmail.com	<i>Muskan</i>
20	Umang Wanthi	9322428500	umangwanthi@gmail.com	<i>Umang</i>
21	Ritika Sondhiya	9175531035	sritikasondhiya@gmail.com	<i>Ritika</i>
22	Kartika Deshmukh	9699720960	kartikadeshmukh20@gmail.com	<i>Kartika</i>
23	Kushi Pali	8767607224	palikushi4@gmail.com	<i>Kushi</i>
24				
10				

Signature of:

Sandeepande
Programme In-charge

[Signature]
COORDINATOR
INTERNAL QUALITY ASSURANCE CELL
DHARAMPETH M. P. DEO MEMORIAL &
SCIENCE COLLEGE, NAGPUR
IQAC Coordinator

[Signature]
Principal
Principal
Dharampeth M.P. Deo Memorial
Science College, Nagpur.



DHARAMPETH M. P. DEO MEMORIAL SCIENCE COLLEGE,
North Ambazari Road, Near Ambazari Lake, Nagpur- 440033

DATA VALIDATION & VERIFICATION (DVV)

25)	Anjali Janvi			<i>[Signature]</i>
26)	Kashish dhule			<i>[Signature]</i>
27)	Dr. Seema ubale			<i>[Signature]</i>
28)	Mrs Shobha zale			<i>[Signature]</i>
29)	Rohini Rajbhaye			<i>[Signature]</i>
30)	Tushar Kashab			<i>[Signature]</i>
31)	Ranjana Deshmukh.			<i>[Signature]</i>
32)	Priyanka Das			<i>[Signature]</i>
33)	Trupti Ambule			<i>[Signature]</i>
34)	Achal			<i>[Signature]</i>
35)	Kiran ghugherkar			<i>[Signature]</i>
36)	Shradha Ozarkar			<i>[Signature]</i>
37)	Tommay Kaware			<i>[Signature]</i>
2-38)	Bhagyashri Selotkar			<i>[Signature]</i>
39)	Aromana Ashtikar			<i>[Signature]</i>

Signature of:

[Signature]
Programme In-charge

[Signature]
CO ORDINATOR
INTERNAL QUALITY ASSURANCE CELL
DHARAMPETH, M. P. DEO MEMORIAL &
SCIENCE COLLEGE, NAGPUR

[Signature]
Principal
Dharampeth M.P. Deo Memorial
Science College, Nagpur.

Dahi Puri



DHARAMPETH M. P. DEO MEMORIAL SCIENCE COLLEGE,
North Ambazari Road, Near Ambazari Lake, Nagpur- 440033

DATA VALIDATION & VERIFICATION (DVV)

49)	Dr. Snehal Natole	snehal.natole16@gmail.com	9890336139	<u>Natole</u>
50)	Mahi. S. Shawase	thawaromali7@gmail.com	9900629566	<u>Shawase</u>
51)	Niharika A. Sute	niharikasute@gmail.com		<u>Sute</u>
52)	Poochi Mainumare			<u>Mainumare</u>
53)	Prof. P. T. Humare	9970468635		<u>Humare</u>
54)	Dr. Amlekar	7776899668		
55)	A. N. Gaikwad	9923103520		<u>Gaikwad</u>

Signature of:

Ganeshpande

Programme In-charge

[Signature]

CO-ORDINATOR
INTERNAL QUALITY ASSURANCE CELL
ICAC Coordinator
DHARAMPETH, M. P. DEO MEMORIAL &
SCIENCE COLLEGE, NAGPUR

[Signature]

Principal
Dharampeth M.P. Deo Memorial
Science College, Nagpur.

Dahi Puri



DHARAMPETH M. P. DEO MEMORIAL SCIENCE COLLEGE,
North Ambazari Road, Near Ambazari Lake, Nagpur- 440033

DATA VALIDATION & VERIFICATION (DVV)

1)	Meghna Pandit			
2)	Shruti Bhivgade			
3)	Ashwini Mam			
4)	Kajal Bhanje			
5)	Manswi Bansod			
6)	S.K. Hambarde			
7)	N.V. Bhalerao			
8)	Acuti Kharole			
9)	Dr. Rupa D. Khandelwal			
10)	Nektal Edlabadkar			
11)	Kirti Paturkar			
12)	Shraddha Deshpande			
13)	Rohini Nagbhaye			
14)				
15)				

Signature of:

Programme In-charge

COORDINATOR
INTERNAL QUALITY ASSURANCE CELL
DHARAMPETH, M. P. DEO MEMORIAL &
SCIENCE COLLEGE, NAGPUR

Principal
Dharampeth M.P. Deo Memorial
Science College, Nagpur.

Dahi Puri



DHARAMPETH M. P. DEO MEMORIAL SCIENCE COLLEGE,
North Ambazari Road, Near Ambazari Lake, Nagpur- 440033

DATA VALIDATION & VERIFICATION (DVV)

	eName	Contact no	g. mail	Signature
(1)	Prachi Navendra Laxkar	8806244619	Prachilaxkar159@gmail.com	Prachi
(2)	Deepika Raju Yadav	7709746445	dy.57.96085@gmail.com	Deepika
(3)	Bharti Jagaman Harne	7057791359	bhushkharne@gmail.com	Bharne
(4)	Bhagyashree Sundaral Ambule	9359139068	ambulebbb7@gmail.com	Ambule

Signature of:

Programme In-charge

CO-ORDINATOR
INTERNAL QUALITY ASSURANCE CELL
DHARAMPETH M. P. DEO MEMORIAL &
SCIENCE COLLEGE, NAGPUR

Principal
Dharampeth M. P. Deo Memorial
Science College, Nagpur.



DHARAMPETH M. P. DEO MEMORIAL SCIENCE COLLEGE, NAGPUR
INTERNAL QUALITY ASSURANCE CELL (IQAC)

Activity Report

Date: 18-10-2022

Name of Organizing Department or Committee: Department of Statistics

Name of the activity: Construction of price and quantity index no. By simple aggregating method

Suggested CRITERION point if any:

Date of Activity: 18th October 2022

Place of Activity: Statistics lab

Name of Guest Speaker/s or Judge/s or Chief Guest/s if any:

Title of the Activity: Construction of price and quantity index no. by simple aggregating method

Number of Participants: 18

Name of the Teacher: Gauri Sinekar

Names of other Committee Members / Staff: N.A.

OUTCOME of the Activity with respect to mission vision of the institute and or academics:

Student get the knowledge about Index no. With the help of simple aggregating method, student find out price and quantity index no. of the base year 2017 and current year 2022. How to analyse data relating to index no.

Activity with newspaper coverage if any: No

Activity data save in PC of: Department of Statistics

Prof. Pitambar Humane
IQAC Coordinator

COORDINATOR
INTERNAL QUALITY ASSURANCE CELL
DHARAMPETH, M. P. DEO MEMORIAL &
SCIENCE COLLEGE, NAGPUR

Name & Signature of Teacher In-charge

Dr. Akhilesh Peshwe
Principal

Principal
Dharampeth M.P. Deo Memorial
Science College, Nagpur.



DHARAMPETH M. P. DEO MEMORIAL SCIENCE COLLEGE NAGPUR

Department of Statistics

Class: B.Sc. Sem.- III

NEP ACTIVITY

Paper II

Unit I

Name of the Teacher: Gauri S. Sinekar

Date: 18/10/22

Title of Activity: Construction of price and quantity index no. By simple aggregating method

Sr. No.	Name of Student	Batch	Mobile No.	Email ID	Signature
---------	-----------------	-------	------------	----------	-----------

1	Ketur S. Bhojar	SCOM	9657957276	keturbhojar53@gmail.com	Ketur
2	Haashal N. Ajinkar	SCOM	9527132359	Haashalajinkar8@gmail.com	H.N. Ajinkar
3	Isha S. Nemade	SCOM	7028494761	ishanemade70@gmail.com	Ishane
4	Vicky A. Singh	SCOM	9834782931	vicky.singh11032001@gmail.com	vicky
5	Suman R. Singh	SCOM	9322018536	sumanrsingh12345678@gmail.com	Suman
6	Savit. B. Singh	S.COM	7258867502	savitbajb@gmail.com	Savit
7	Prayakta Pawar	SCOM	9356905159	prayakta2004@gmail.com	Prayakta
8	Swamini S. Rajinkar	S.COM	9822200598	SwaminiRajinkar@gmail.com	Swamini
9	Vrushali Shahane	SCOM	9307516332	vrushalishahane25@gmail.com	Vrushali
10	Aman D. Chauhan	S.COM	729444153	amanchauhan21@gmail.com	Aman
11	Anjali V. Rangankar	S.COM	830031253	anjalihangankar42@gmail.com	Anjali
12	Purushottam Pawar	SCOM	700693071	purushottam.pawar@gmail.com	Purushottam
13	Sarthak Jichkar	SCOM	8605710818	Sarthakjichkar@gmail.com	Sarthak
14	Avishkar A. Bansode	SCOM	7870841958	avishkarbansode@gmail.com	Avishkar
15	Sumit Sahil	SCOM	952240382	sumitsahil1234@gmail.com	Sumit
16	Devang Karia	SCOM	7888238500	devangkar@gmail.com	Devang
17	Khushi Waghade	SCOM	9156520783	khushiwaghade7@gmail.com	Khushi
17	Vishruti Jadhav	SCOM	9156116385	vishrutijadhav93@gmail.com	Vishruti

G. Sinekar
Signature of Teacher

G. Sinekar
Teacher Incharge



DHARAMPETH M. P. DEO MEMORIAL SCIENCE COLLEGE, NAGPUR
INTERNAL QUALITY ASSURANCE CELL (IQAC)
NEP Activity Report

Date: 31/10/2022

Name of Organizing Department or Committee: Chemistry
Name of the activity: NEP Activity Report (Sem V, paper II, Unit III)
Suggested CRITERION point if any: Criteria II
Date of Activity: 18-10-2022
Place of Activity: Department of Chemistry
Name of Guest Speaker/s or Judge/s or Chief Guest/s if any- Nil
Title of the Activity: Identification of photochemical reaction
Number of Participants: 40
Name of the Teacher In-charge / Convener: Dr. Mrs. Mrudul R. Keskar
Names of other Committee Members / Staff: Dr. Mrs. V. P. Meshram

OUTCOME of the Activity with respect to mission vision of the institute and or academics:

This is a student's centric activity. It is a chemical reaction triggered when light energy is absorbed by a substance's molecule. Phosphorescence is a physical phenomenon. Students get the idea about the process in which energy absorbed by any object is released in the form of light.

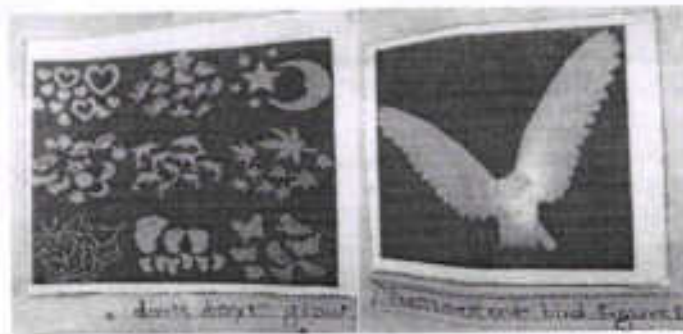

Activity with newspaper coverage if any: Nil

Activity data saved in PC of: Chemistry Department

Note: Kindly share Jio tag photographs separately along with report on igacdsc2022@gmail.com

Prof. Pitambar Humane
IQAC Coordinator

CO ORDINATOR
INTERNAL QUALITY ASSURANCE CELL
DHARAMPETH, M. P. DEO MEMORIAL &
SCIENCE COLLEGE, NAGPUR

Name & Signature of Teacher In-charge

(Dr. Mrs. Mrudul R. Keskar)

Dr. Akhilesh Peshwe
Principal

PRINCIPAL

Dharampeth M.P. Deo Memorial
Science College, Nagpur-440033



DHARAMPETH M. P. DEO MEMORIAL SCIENCE COLLEGE,
North Ambazari Road, Near Ambazari Lake, Nagpur- 440033

DATA VALIDATION & VERIFICATION (DVV)

Name of the Programme : NEP Activity (Identification of photochemical reaction)
Date of the Programme : 18-10-2022 (Sem V, Paper II, Unit III)
Name of Chief Guest if any : _____
Name of Guest Speaker if any : _____

Sr. No.	Name of the Participant	Mobile Number	E-mail Id	Signature
1.	Krushnali Kady	9625856995	krushnali.kady@gmail.com	
2.	Bhumnika Chudge	9930391103	bhumnika.chudge@gmail.com	
3.	Sayali Lokhande	9350413009	sayali.lokhande@gmail.com	
4.	Nandani Hadge	9370301679	nandani.hadge@gmail.com	
5.	Jyotsna Jone	7752052514	jyotsna.jone@gmail.com	
6.	Anushree Wale	9530778633	anushree.wale201@gmail.com	
7.	Aranti Chapekar	7875173047	arantikol@gmail.com	
8.	Saniya Naik	9370570457		
9.	Arpita T. Dakhale	8010866758	arpitadakhale@gmail.com	
10.	Vishakha Gurohadre	7670351270	vishakharoz@gmail.com	
11.	Mrunali Sonawane	9850163812	sonawane.mrunali@gmail.com	
12.	Vanshika Yede	7558246609		
13.	Shruti Pawar	9527989707		
14.	Saniya P. Naik	9370570457		

Signature of:
Programme in-charge

CO ORDINATOR
INTERNAL QUALITY ASSURANCE CELL
DHARAMPETH, M. P. DEO MEMORIAL &
SCIENCE COLLEGE, NAGPUR

PRINCIPAL
Dharampeth M.P. Deo Memorial
Science College, Nagpur-440033



DHARAMPETH M. P. DEO MEMORIAL SCIENCE COLLEGE,
North Ambazari Road, Near Ambazari Lake, Nagpur- 440033

DATA VALIDATION & VERIFICATION (DVV)

16	Aarti Bisen	8767549078		Bin
17	Nandini Pourniker	9370418064	nandini.pourniker@gmail.com	(Name)
18	Aachal Wagh	9579642389	aachalwagh@gmail.com	Deugh
19	Divya Bondre	8668454925	divyabondre3@gmail.com	Bkum
20	Neha Waghade	7229895144	nehawagh102005@gmail.com	Neha
21	Vishal Kumar Singh	9610187225		Vishal
22	Amit Waide	9168496255	Amitwaide440divya@gmail.com	Amit
23	Anshuman Sharma	9320892602		sharma
24	Franksha R. Yelke	8267935724		Frank
25	Adesh Hatwar			A.K. Hatwar
26	Muskan H. Steikhe	8055676833		Ashu
27	Pragya R. Jha	9665952975	pragya.jc97@gmail.com	Pragya
28	Raji Phaten	8669595198		Rajaten
29	Ishwar Suryawashi	8087317297		Ishu
30	Suraj Babasaheb Shende	935666787	surajshende1018@gmail.com	Suraj

Signature of:

afok

Programme In-charge

[Signature]

CO-ORDINATOR
INTERNAL QUALITY ASSURANCE CELL
DHARAMPETH, M. P. DEO MEMORIAL &
SCIENCE COLLEGE, NAGPUR

[Signature]

PRINCIPAL
Dharampeth M. P. Deo Memorial
Science College, Nagpur-440033



DHARAMPETH M. P. DEO MEMORIAL SCIENCE COLLEGE,
North Ambazari Road, Near Ambazari Lake, Nagpur- 440033

DATA VALIDATION & VERIFICATION (DVV)

31.	Raksha Dhote	7498511875	rakshadhote3@gmail.com Pshu
32.	Sayali Pandharpande	8208121910	Sayali Patil4@gmail.com SZ
33.	Ankita Bhoyar	8788031173	Ankitabhoy7@gmail.com Ankita
34.	Manali Shende	7269637634	manalishende@62@11 Shu
35.	Suhani Pournikan	9370419064	suhaniournikan@gmail.com stupan
36.	Sakshi Chamate	7570920488	Sakshi
37.	Arpita Dakhele	8010866758	arpita
38.	Yasustabh P. Ramteke	7218487714	ramtekeyasustabh2002@gmail.com Yea
39.	Neha Kharwar	8766738340	nehakarwar2k@gmail.com Neha
40.	Sonam Upade	9890230462	upadesonam@gmail.com Bupade

Signature of:

Programme In-charge

COORDINATOR
INTERNAL QUALITY ASSURANCE CELL
DHARAMPETH, M. P. DEO MEMORIAL &
SCIENCE COLLEGE, NAGPUR

Principal
PRINCIPAL
Dharampeth M.P. Deo Memorial
Science College, Nagpur-440033



DHARAMPETH M. P. DEO MEMORIAL SCIENCE COLLEGE, NAGPUR

INTERNAL QUALITY ASSURANCE CELL (IQAC)

Activity Report

Date: 19/10/2022

Name of Organizing Department or Committee: Department of Physics

Name of the activity: NEP based Demonstration Activity for B.Sc. Sem-I

Suggested CRITERION point if any: Restricted to RTMNU BSc physics syllabus.

Date of Activity: 19 /10 /2022

Place of Activity: Room no. 004

Name of Guest Speaker/s or Judge/s or Chief Guest/s if any: NA

Title of the Activity: Dielectrics and surface area dependent capacitance

Activity with newspaper coverage if any: No

Number of Participants: BSc Sem-I Students – 11

Name of the Teacher In-charge / Convener: Mr. Roshan B. Raut

Names of other Committee Members / Staff: N.A.

OUTCOME of the Activity with respect to academics:

This demonstration provided BSc Sem-I students to learn the Dielectrics and surface area dependent capacitance. In this activity a piece of aluminium foil was rolled in cylindrical shape and connect two electrodes form a capacitor. On other hand a piece of aluminium foil was rolled with Lab synthesize dielectric material in cylindrical shape and connect two electrodes form a capacitor with dielectric. Both the capacitors were charged and discharge through LED and observed the charge storage capacity. This demonstration helped students to understand the concept of Dielectrics and surface area dependent capacitance. The activity was also repeated for a rectangular plate type capacitors.

DVV: Enclosed.

Activity data save in PC of: Lt. Dr. P. W. Ambekar

Name & Signature of Teacher In-charge

Prof. Pitambar Humane
IQAC Coordinator

CO ORDINATOR

INTERNAL QUALITY ASSURANCE CELL
DHARAMPETH, M. P. DEO MEMORIAL &
SCIENCE COLLEGE, NAGPUR

Dr. Akhilesh Peshwe
Principal
Principal

Dharampeth M.P. Deo Memorial
Science College, Nagpur.



DHARAMPETH M. P. DEO MEMORIAL SCIENCE COLLEGE NAGPUR

Department of Physics

Class: B.Sc. Sem.- I

NEP ACTIVITY

Paper- 2

Unit- 2

Name of the Teacher: R. B. Raut

Date: 19/10/2022

Title of Activity: Dielectrics and surface area dependent capacitance

Sr. No.	Name of Student	Batch	Mobile No.	Email ID	Signature
---------	-----------------	-------	------------	----------	-----------

1-	Ritika Bhoyar	F8	9834587087	ritikabhoyar28@gmail.com	
2-	Konishma P. Prasad	F8	9309318667	naveendepasad32@gmail.com	Konishma
3.	Saurabh Chaudhary	F8	9359883501	schaudhary5599	
4.	Ankit R. Patel.	F8	9970905638	ankitpatel797275@gmail.com	
5.	Ruchi P. Dwivedi	PF	8080776893	Ruchidwivedi123@gmail.com	
6.	Pratibha Bhusari	F8	7821048413	pbhusari718@gmail.com	
7.	Shivam Potel	F7	7038889083	sp040263@gmail.com	Shivam
8.	Monika I. Patel	F8	7499225468	MonikaPatel7032@gmail.com	
9.	Ankit R. Patel	F8	9970905638	ankitpatel797275@gmail.com	
10.	Sheldal .O. Patle	F8	9764596337	Sp085563@gmail.com	
11.	Saniksha. A. Panchbudhe	F5	9763075890	sanikshapanchbudhe@gmail.com	Saniksha

Signature of Teacher

HEAD
DEPARTMENT OF PHYSICS
Dharampeth M. P. Deo Memorial
Science College, Nagpur



**DHARAMPETH M. P. DEO MEMORIAL SCIENCE COLLEGE, NAGPUR
ROTARACT CLUB OF DMPDSVM**

Activity Report

Date: 30 /10/2022

Name of Organizing Department or Committee: ROTARACT CLUB OF DMPDSVM

Name of the activity: Big Billion Smile: Gift Hamper Donation

Suggested CRITERION point if any: Criterion III & Criterion V

Date of Activity: 21st October 2022

Place of Activity: In collaboration with Home Science Department

Name of Guest Speaker/s or Judge/s or Chief Guest/s if any: NIL

Title of the Activity: Diwali Gift

Number of Participants: 21

Name of the Teacher In-charge / Convener: Dr.Mrs.Shraddha Deshpande

Names of other Committee Members / Staff: Rotaract Club Members

OUTCOME of the Activity with respect to mission vision of the institute and or academics:

Activity with newspaper coverage if any: NIL

Activity data save in PC of: Department of English



Prof. Pitambar Humane
IQAC Coordinator

CO ORDINATOR
INTERNAL QUALITY ASSURANCE CELL
DHARAMPETH, M. P. DEO MEMORIAL &
SCIENCE COLLEGE, NAGPUR

Dr. Mrs. Shraddha Deshpande
Teacher In-charge

Dr. Akhilesh Peshwe
Principal
Principal
Dharampeth M.P. Deo Memorial
Science College, Nagpur.



DHARAMPETH M.P.DEO MEMORIAL SCIENCE COLLEGE, NAGPUR

ROTARACT CLUB 22-23

Big Billion Smile: Gift Hamper Donation

21st October 2022

Rotary.org Link



Instagram Link





DHARAMPETH M.P.DEO MEMORIAL SCIENCE COLLEGE, NAGPUR

ROTARACT CLUB 22-23

Big Billion Smile: Gift Hamper Donation

21stOctober 2022

List of Students

Sr.	Name	Contact Number
1	Harsh kodape	9604677672
2	AnanyaMotghare	7219218955
3	GargiHadge	7972076671
4	Nupur Sharma	9322042259
5	PrajwalBhoyar	8010434634
6	SaniaMidhatRaza	8975726700
7	VaishnaviGadge	9022976449
8	VedantBaxy	8530455796
9	Aditi Lute	7820812303
10	RenukaLande	7719951401
11	SanchitaPatil	7218079074
12	Dhammapritilale	9975037356
13	AvishkarBansod	7820841788
14	KhushabuChoudhari	7262074960
15	KartikaDeshmukh	9699720960
16	KunalDigrase	8007525770
17	MuskanKulkarni	9156889239
18	Siddhi Tiwari	8087143696
19	MahiThaware	9960625966
20	RitikaSondhiya	9175581655
21	UmangWarthi	9322428500

Prof. Pitambar Humane
IQAC Coordinator

CO ORDINATOR
INTERNAL QUALITY ASSURANCE CELL
DHARAMPETH, M. P. DEO MEMORIAL &
SCIENCE COLLEGE, NAGPUR

Dr. Mrs. Shraddha Deshpande
Teacher In-charge

Dr. Akhilesh Peshwe
Principal
Dharampeth M.P. Deo Memorial
Science College, Nagpur.



DHARAMPETH M. P. DEO MEMORIAL SCIENCE COLLEGE, NAGPUR

INTERNAL QUALITY ASSURANCE CELL (IQAC)
Activity Report

Date: 21/11/2022

Name of Organizing Department or Committee: Department of Statistics

Name of the activity: Activity on Cluster sampling (using excel)

Suggested CRITERION point if any: Restricted to RTMNU BSc Statistics syllabus.

Date of Activity: 21/10/2022

Place of Activity: Statistics Lab

Name of Guest Speaker/s or Judge/s or Chief Guest/s if any: NA

Title of the Activity: Drawing of cluster random sample in excel

Activity with newspaper coverage if any: No

Number of Participants: 20

Name of the Teacher: Ms. Kumudini Kadbe

Names of other Committee Members / Staff: N.A.

OUTCOME of the Activity with respect to academics:

This activity provided a unique opportunity to BSc Sem-V students to learn how to draw cluster sample using excel. This activity developed interest among students to learn different aspects of excel to perform other activities.

DVV: Enclosed.

Activity data save in PC of: Lt. Dr. P. W. Ambekar

Prof. Pitambar Humane
IQAC Coordinator

CO ORDINATOR
INTERNAL QUALITY ASSURANCE CELL
DHARAMPETH, M. P. DEO MEMORIAL &
SCIENCE COLLEGE, NAGPUR

Name & Signature of Teacher In-charge

Dr. Akhilesh Peshwe
Principal

Principal
Dharampeth M.P. Deo Memorial
Science College, Nagpur.



DHARAMPETH M. P. DEO MEMORIAL SCIENCE COLLEGE NAGPUR

Department of Statistics

Class: B.Sc. Sem.- V

NEP ACTIVITY

Paper- II

Unit- IV

Name of the Teacher: Kumudini Kadbe

Date: 21/10/22

Title of Activity: Drawing of cluster random sample in excel

Sr. No.	Name of Student	Batch	Mobile No.	Email ID	Signature
1	Peachi S Manusmare	PSM 170	9356969609	peachimanusmare1@gmail.com	
2	Himanshu R. Lakhe	PSM	7448252469	himanshulakhe08@gmail.com	
3	Pijush G. Kapre	PSM	9373563027	kaprepijush03@gmail.com	
4	Pratiksha S. Thakre	PSM	8459570299	Pratikshathakre1709@gmail.com	
5	Divyani V. Chude	PSM	7030737121	divyanichude2002@gmail.com	
6	Uday P. Kondarkar	PSM	9545397191	udaykondarkar82@gmail.com	
7	Sareshi L. Borapatre	PSM	8317219372	Sareshi2002bb@gmail.com	
8	Vaibhav S. Rane	PSM	7744951383	vaibhavsane2207@gmail.com	
9	Prof. G. Gokulwad	PSM	7620511383	Profgokulwad1999@gmail.com	
10	Vishal V. Gokhale	SCOM	962368472	Whobirkhale22@gmail.com	
11	Rishikesh R. Dethe	SCOM	8788199260	rshikeshdethe2001@gmail.com	
12	Saurabh Raut	SCOM	9527283213	saurabhraut1995@gmail.com	
13	Neha J. Bankar	SCOM	8055471553	neha2002bankar@gmail.com	
14	Sahil R. Jitade	SCOM	9373424643	sahiljitade75@gmail.com	
15	Diya R. Pali	SCOM	7757052403	diyaipali1553@gmail.com	
16	Tanu S. Mahule	SCOM	7059844982	tanumahule45@gmail.com	
17	Sumit Shalke	SCOM	3021627757	sumitshalke062@gmail.com	
18	Komal M Kumbhar	SCOM	7620314869	KUMBHAR KOMAL 94@gmail.com	
19	Pranjal D. Sawdhan	SCOM	7355455510	pranjal15awdhan123@gmail.com	
20	Satish P. Patil	SCOM	9422820045	satishpatil2001@gmail.com	

Signature of Teacher

Teacher Incharge



**DHARAMPETH M. P. DEO MEMORIAL SCIENCE COLLEGE, NAGPUR
ROTARACT CLUB OF DMPDSVM**

Activity Report

Date: 30/10/2022

Name of Organizing Department or Committee: ROTARACT CLUB OF DMPDSVM

Name of the activity: World Polio Day

Suggested CRITERION point if any: Criterion III & Criterion V

Date of Activity: 24th October 2022

Place of Activity: In collaboration with Home Science Department

Name of Guest Speaker/s or Judge/s or Chief Guest/s if any: NIL

Title of the Activity: World Polio Day

Number of Participants: 21

Name of the Teacher In-charge / Convener: Dr.Mrs.Shraddha Deshpande

Names of other Committee Members / Staff: Rotaract Club Members

OUTCOME of the Activity with respect to mission vision of the institute and or academics:

World Polio Day is commemorated on 24th October every year. Polio is a highly contagious disease caused by the polio virus. Although very rare, the virus can attack the parts of the brain that help you breathe, which can lead to death. Polio has no cure, but it can be prevented with vaccination.

Activity with newspaper coverage if any: NIL

Activity data save in PC of: Department of English

Prof. Pitambar Humane
IQAC Coordinator

CO ORDINATOR
INTERNAL QUALITY ASSURANCE CELL
DHARAMPETH, M. P. DEO MEMORIAL &
SCIENCE COLLEGE, NAGPUR

Dr. Mrs. Shraddha Deshpande
Teacher In-charge

Dr. Akhilesh Peshwe
Principal
Principal
Dharampeth M.P. Deo Memorial
Science College, Nagpur.



DHARAMPETH M.P.DEO MEMORIAL SCIENCE COLLEGE, NAGPUR

ROTARACT CLUB 22-23

World Polio Day

24th October 2022

Instagram Link





DHARAMPETH M.P.DEO MEMORIAL SCIENCE COLLEGE, NAGPUR

ROTARACT CLUB 22-23

World Polio Day

24thOctober 2022

List of Students

Sr.	Name	Contact Number
1	Harsh kodape	9604677672
2	AnanyaMotghare	7219218955
3	GargiHadge	7972076671
4	Nupur Sharma	9322042259
5	PrajwalBhoyar	8010434634
6	SaniaMidhatRaza	8975726700
7	VaishnaviGadge	9022976449
8	VedantBaxy	8530455796
9	Aditi Lute	7820812303
10	RenukaLande	7719951401
11	SanchitaPatil	7218079074
12	Dhammapritilale	9975037356
13	AvishkarBansod	7820841788
14	KhushabuChoudhari	7262074960
15	KartikaDeshmukh	9699720960
16	KunalDigrase	8007525770
17	MuskanKulkarni	9156889239
18	Siddhi Tiwari	8087143696
19	MahiThaware	9960625966
20	RitikaSondhiya	9175581655
21	UmangWarthi	9322428500

Prof. Pitambar Humane
IQAC Coordinator

CO ORDINATOR
INTERNAL QUALITY ASSURANCE CELL
DHARAMPETH, M. P. DEO MEMORIAL &
SCIENCE COLLEGE, NAGPUR

Dr. Mrs. Shraddha Deshpande
Teacher In-charge

Dr. Akhilesh Peshwe
Principal
Principal
Dharampeth M.P. Deo Memorial
Science College, Nagpur.



DHARAMPETH M. P. DEO MEMORIAL SCIENCE COLLEGE, NAGPUR

INTERNAL QUALITY ASSURANCE CELL (IQAC)

Activity Report

Date: 26/10/2022

Name of Organizing Department or Committee: Department of Physics

Name of the activity: NEP based Demonstration Activity for B.Sc. Sem-I

Suggested CRITERION point if any: Restricted to RTMNU BSc physics syllabus.

Date of Activity: 26 /10 /2022

Place of Activity: Room no. 004

Name of Guest Speaker/s or Judge/s or Chief Guest/s if any: NA

Title of the Activity: Demonstration of Kirchhoff's law

Activity with newspaper coverage if any: No

Number of Participants: BSc Sem-I Students – 10

Name of the Teacher In-charge / Convener: Mr. Roshan B. Raut

Names of other Committee Members / Staff: N.A.

OUTCOME of the Activity with respect to academics:

This demonstration for BSc Sem-I students is conducted to learn the Kirchhoff's law. In this activity a LED was connected in a circuit with a battery 5V through a Resistor 200 Ohm in a series. The potential drop across the LED, Resistor measured separately noted down. The potential drop across LED and Resistor was found to be equal to the potential drop across the LED, Resistor measured separately. This demonstration helped students to understand the concept of Kirchhoff's Voltage law.

DVV: Enclosed.

Activity data save in PC of: Lt. Dr. P. W. Ambekar

Prof. Pitambar Humane
IQAC Coordinator

CO ORDINATOR
INTERNAL QUALITY ASSURANCE CELL
DHARAMPETH, M. P. DEO MEMORIAL &
SCIENCE COLLEGE, NAGPUR

Name & Signature of Teacher In-charge

Dr. Akhilesh Peshwe
Principal
Principal
Dharampeth M.P. Deo Memorial
Science College, Nagpur.



DHARAMPETH M. P. DEO MEMORIAL SCIENCE COLLEGE, NAGPUR

INTERNAL QUALITY ASSURANCE CELL (IQAC)
Activity Report

Date: 31/10/2022

Name of Organizing Department or Committee: Department of Statistics

Name of the activity: Activity on proportion

Suggested CRITERION point if any: Restricted to RTMNU BSc Statistics syllabus.

Date of Activity: 31/10/2022

Place of Activity: Statistics Lab

Name of Guest Speaker/s or Judge/s or Chief Guest/s if any: NA

Title of the Activity: Determination of proportion of left handed persons in college

Activity with newspaper coverage if any: No

Number of Participants: 20

Name of the Teacher: Ms. Kumudini Kadbe

Names of other Committee Members / Staff: N.A.

OUTCOME of the Activity with respect to academics:

This activity is designed to give students engaging practice in the use of ratios and proportions. The activity include movement to help stimulate student participation, which encourages full engagement in the learning process.

DVV: Enclosed.

Activity data save in PC of: Lt. Dr. P. W. Ambekar

Prof. Pitambar Humane
IQAC Coordinator

CO ORDINATOR
INTERNAL QUALITY ASSURANCE CELL
DHARAMPETH, M. P. DEO MEMORIAL &
SCIENCE COLLEGE, NAGPUR

Name & Signature of Teacher In-charge

Dr. Akhilesh Peshwe
Principal

Principal
Dharampeth M.P. Deo Memorial
Science College, Nagpur.



DHARAMPETH M. P. DEO MEMORIAL SCIENCE COLLEGE NAGPUR

Department of Statistics

Class: B.Sc. Sem.- V

NEP ACTIVITY

Paper- II

Unit- II

Name of the Teacher: Kumudini Kadbe

Date: 31/10/22

Title of Activity: Determination of proportion of left handed person in college

Sr. No.	Name of Student	Batch	Mobile No.	Email ID	Signature
1	Peachi S. Manuismare	PSM II	9356969609	peachimanuismare@gmail.com	<u>P. Manuismare</u>
2	Himanshu R. Lakhe	PSM	7448252469	himanshulakhe08@gmail.com	<u>hlakhe</u>
3	Piyush G. Kapre	PSM	9373562027	kaprepiyush03@gmail.com	<u>P. Kapre</u>
4	Pratiksha S. Thakre	PSM	8459570299	Pratikshathakre1709@gmail.com	<u>Pratiksha</u>
5	Divyani V. Dhule	PSM	7030731921	divyanidhule2002@gmail.com	<u>Divyani</u>
6	Uday P. Khandarkar	PSM	9545997196	udaykhandarkar38@gmail.com	<u>U. Khandarkar</u>
7	Scalshi L. Borapatre	PSM	8217219372	Scalshi2002bb@gmail.com	<u>Scalshi</u>
8	Vaibhav S. Rane	PSM	7744951383	Vaibhavrane2203@gmail.com	<u>V. Rane</u>
9	Pranav G. Ghatge	PSM	7620511383	Pranavgatge1999@gmail.com	<u>P. Ghatge</u>
10	Saurabh V. Raut	SCOM	987289313	Saurabh2014725@gmail.com	<u>S. Raut</u>
11	Vihari V. Giribale	SCOM	9673681477	VihariGiribale27@gmail.com	<u>V. Giribale</u>
12	Rishikesh Dethle	SCOM	8788199360	Rishikeshdethle2002@gmail.com	<u>R. Dethle</u>
13	Neha J. Bankar	SCOM	8055477553	neha2002bankar@gmail.com	<u>N. Bankar</u>
14	Sahil P. Jitode	SCOM	9373414643	sahiljitode73@gmail.com	<u>S. Jitode</u>
15	Diya R. Patil	SCOM	7757052463	diyaPatil953@gmail.com	<u>D. Patil</u>
16	Suman B. Lakhe	SCOM	9021627757	sumanblakhe2020@gmail.com	<u>S. Lakhe</u>
17	Tanu S. Mohule	SCOM	7057844882	tanumohule41@gmail.com	<u>T. Mohule</u>
18	Komal M. Kumbhare	SCOM	7620314869	Kumbhare Komal 94@gmail.com	<u>K. Kumbhare</u>
19	Jayraj P. Panke	SCOM	9422498044	Jayrajpanke2002@gmail.com	<u>J. Panke</u>
20	Pranjal D. Samulkar	SCOM	7395458510	PranjalSamulkar1244@gmail.com	<u>P. Samulkar</u>

Signature of Teacher

Teacher Incharge



DHARAMPETH M. P. DEO MEMORIAL SCIENCE COLLEGE, NAGPUR
INTERNAL QUALITY ASSURANCE CELL (IQAC)
Activity Report

Date: 23/01/2023

Name of Organizing Department or Committee: English Department

Name of the activity: Poster Competition

Suggested CRITERION point if any: Criteria V

Date of Activity: 1-11 2022

Place of Activity: College १२७

Name of Guest Speaker/s or Judge/s or Chief Guest/s if any: Nil

Title of the Activity: Poster Competition

Number of Participants:

Name of the Teacher In-charge / Convener: Dr.Mrs.Shraddha Deshpande

Names of other Committee Members / Staff: Dr.Akhilesh Peshwe (Principal)

OUTCOME of the Activity with respect to mission vision of the institute and or academics:

To bring out the creative expression of students and to gauge their knowledge and awareness on the topics from their syllabus a poster making activity was conducted.

Activity with newspaper coverage if any: Nil

Activity data save in PC of: English Department

Prof. Pitambar Humane
IQAC Coordinator

CO ORDINATOR
INTERNAL QUALITY ASSURANCE CELL
DHARAMPETH, M. P. DEO MEMORIAL &
SCIENCE COLLEGE, NAGPUR

Dr. Mrs. Shraddha Deshpande
Teacher Incharge

Dr. Akhilesh Peshwe
Principal
Dharampeth M.P. Deo Memorial
Science College, Nagpur.



Dharampeth M.P.Deo Memorial Science College, Nagpur



Department of English
NOTICE

Academic Session 2022-2023

POSTER COMPETITION

All the students are hereby informed that English Department is organizing a
A Poster Competition on following themes:

- 1. Preposition**
- 2. Subject Verb Agreement**

- Poster should be on A4 Size paper.
- Students can use A4 size handmade sheets also.
- Poster will be judged on the content, use of language, presentation and creativity.
- Poster should be made in pairs.

Posters should be presented on **1st November 2022**, at 1.00 p.m in Room. No. 10.



Dr. Shraddha Deshpande
Head,
Department of English
13/10/22

Dr. Shraddha Deshpande
Head, Department of English
Dharampeth M.P. Deo Memorial
Science College, Nagpur



DHARAMPETH M. P. DEO MEMORIAL SCIENCE COLLEGE,
North Ambazari Road, Near Ambazari Lake, Nagpur- 440033

DATA VALIDATION & VERIFICATION (DVV)

Name of the Programme : Poster (English Activity)
Date of the Programme : 1st Nov 2022
Name of Chief Guest if any : _____
Name of Guest Speaker if any : _____

Sr. No.	Name of the Participant	Mobile Number	E-mail Id	Signature
1.	Siddhi B. Tiwari	8087143696	siddhitiwari0721@gmail.com	
2.	Mahi S. Thaware	9960629566	thawaremahis7@gmail.com	
3.	Kartika M. Deshmukh	9699720960	kartikamd20@gmail.com	
4.	Umang G. Warthi	9322428500	umangwarthi@gmail.com	
5.	Ritika R. Sondhiya	917551655	ritikasondhiya@gmail.com	
6.	Sonalie Chaudhari	8856055003	sonalichaudhari9@gmail.com	
7.	Muskan Kulkarni	9156889239	muskanmkulkarni34@gmail.com	
8.	Aakansha mairal	8010923662	aakanyogi2004@gmail.com	
9.	Neha L. Manjari	9373832266	nehawanjari755@gmail.com	
10.	Khushi K. Rewade	9588445994	Khushirewade@gmail.com	

Signature of:

Programme In-charge
Dr. Shraddha Deshpande
Head, Department of English
Dharampeth M.P. Deo Memorial
Science College, Nagpur

CO-ORDINATOR
IQAC COORDINATOR
INTERNAL QUALITY ASSURANCE CELL
DHARAMPETH, M. P. DEO MEMORIAL &
SCIENCE COLLEGE, NAGPUR

Principal
Dharampeth M.P. Deo Memorial
Science College, Nagpur.



DHARAMPETH M. P. DEO MEMORIAL SCIENCE COLLEGE,
North Ambazari Road, Near Ambazari Lake, Nagpur- 440033

DATA VALIDATION & VERIFICATION (DVV)

11.	Anshul Yuvraj Kinnapure	9284067169	anshulkinapure650@gmail.com	Anshul
12.	Krutika S. Bokale	9021533341	pokalekrutika@gmail.com	Krutika
13.	Riya A. Singh	9595649831	riyaas2307@gmail.com	Riya Singh
14.	Shreyas A. Jha	8983236002	Sangeetajha0303@gmail.com	Shreyas
15.	Yashraj K. Pandey	9156035297	pandeykr54@gmail.com	Yashraj
16.	Sunaina P. Chichonde	8530970132	Sunainachichonde@gmail.com	Chichonde
17.	Dally K. Narjai	9826013213	Krishnanarjai12345@gmail.com	Dally
18.	Komalika S. Chaudhari	9822033866	KomalikaChaudhari07X@gmail.com	Komalika
19.	Shanku L. Umare	9284244534	shankulumare1912@gmail.com	Shanku
15.	Ghanashree U. Dhomare	8459807047	ghanashreedhomare@gmail.com	Ghanashree
16.	Apeksha S. Katangale	7559455794	apekshakatangale26@gmail.com	Katangale
17.	Priyanka Y. Chavhan	9099654562	priyankachavhan69@gmail.com	Chavhan
18.	Chanchal K. Waghmare	7196016894	waghmarechanchal@gmail.com	Chanchal
19.	Durgesh K. Ghodmare	9075318618	durgeshghodmare011@gmail.com	Durgesh
20.	Neha L. Hanjari	9373932266	nehahanjari@gmail.com	Neha

Signature of:

Dr. Shradha Deshpande
Programme in Charge
Head, Department of English
Dharampeth M.P. Deo Memorial
Science College, Nagpur.

CO-ORDINATOR
INTERNAL IQAC COORDINATOR
DHARAMPETH, M. P. DEO MEMORIAL &
SCIENCE COLLEGE, NAGPUR

Principal
Dharampeth M.P. Deo Memorial
Science College, Nagpur.



DHARAMPETH M. P. DEO MEMORIAL SCIENCE COLLEGE,
North Ambazari Road, Near Ambazari Lake, Nagpur- 440033

DATA VALIDATION & VERIFICATION (DVV)

21	Shruti Chanekar	shrutichannekar2009@gmail.com	Shruti Chanekar
22)	Gunjan Bhojare	gunjan8665335876	gunjanbhojare39@gmail.com Gunjan
23)	Ruchi P. Dwivedi	ruchi8080776893	Ruchidwivedi330@gmail.com Ruchi
24)	Nihal V. Meshram	nihal8767292960	nihalmeshram74@gmail.com N.V. Meshram
25)	Mansurli D. Bhilkar.	9992727616	Mansurli D. Bhilkar@gmail.com Mansurli
26)	Tejus R Chetmelwar	3604662119	Tejus Chetmelwar@gmail.com Tejus
27)	Badal Gendal Somkuwar	7448247750	badalsomkuwar1@gmail.com Badal
28)	Divyani G. Zade	7972403069	divyanizade2009@gmail.com Divyani
29)	Khushi Pali	8767607224	PaliKhushi@gmail.com Khushi

Signature of:

Programme In-charge
Dr. Shraddha Deshpande
 Head, Department of English
 Dharampeth M.P. Deo Memorial
 Science College, Nagpur

CO-ORDINATOR
INTERNATIONAL QUALITY ASSURANCE CELL
DHARAMPETH, M. P. DEO MEMORIAL &
SCIENCE COLLEGE, NAGPUR

Principal
 Dharampeth M.P. Deo Memorial
 Science College, Nagpur.



DHARAMPETH M. P. DEO MEMORIAL SCIENCE COLLEGE,
North Ambazari Road, Near Ambazari Lake, Nagpur- 440033

DATA VALIDATION & VERIFICATION (DVV)

Name of the Programme : Poster (English Activity)
Date of the Programme : 1st Nov 2022
Name of Chief Guest if any : _____
Name of Guest Speaker if any : _____

Sr. No.	Name of the Participant	Mobile Number	E-mail Id	Signature
1.	Nisha v Pandey	8605231990	abhisek8605231990@gmail.com	Nisha
2.	Abhay P. Tembhore	8975363145	abhay230102@gmail.com	Abhay
3.	Nitu B. Rai	7058638984	rainitu1419@gmail.com	Nitu
4.	Sanjana . S. Tabhane	9699186571	tabhanesanjana@gmail.com	Sanju
5.	Manithrani . M. Todase	809050430	manithranitodase@gmail.com	Mani
6.	Pranali R. Dehankar	8767581278	Pelehra@gmail.com	Pranali
7.	Anjali Thakre	7066554821	thakreanjur381@gmail.com	Anjali
8.	Anvay Borkar	9168538614	anvayborkar@gmail.com	Anvay
9.	Sejal Kolhe	8483045985	KolheSejal04@gmail.com	Sejal
10.	Sanyak M. Hadke	7020171304	sanyakhadke30@gmail.com	Sanyak

Signature of:

Programme In-charge
Dr. Shraddha Deshpande
Head, Department of English
Dharampeth M.P. Deo Memorial
Science College, Nagpur.

IQAC COORDINATOR
INTERNAL QUALITY ASSURANCE CELL
DHARAMPETH M. P. DEO MEMORIAL &
SCIENCE COLLEGE, NAGPUR

Principal
Dharampeth M.P. Deo Memorial
Science College, Nagpur.





DHARAMPETH M. P. DEO MEMORIAL SCIENCE COLLEGE,
North Ambazari Road, Near Ambazari Lake, Nagpur- 440033

DATA VALIDATION & VERIFICATION (DVV)

11	Priya B. Sharma	8010764549	priyasharma19012004@gmail.com	Sharma
12	Meenal . A. Chaudhary	9529014604	meenalchaudhary2002@gmail.com	Chaudhary
13	Lucky A Vishwakarma	9579680186	lvishwakarma24@gmail.com	Vishwakarma
14	Sunaina chichonde	8530970132	sunainachichonde@gmail.com	Sunaina
15	Ashlesha khadgi		AshleshaKhadgi@gmail.com	Ashlesha
16	Gunjan I. Bhoys	7666799586	gunjanbhoys@gmail.com	Gunjan
17	Kalyani R. Sindram	8446539622	kalyanisindram@gmail.com	K.Sindram
18	Rohan .H. Meshram	7499956761	rohanmeshram49@gmail.com	Rmeshram
19	Vaidehi P. Thote	7558499191	vaidehitote27@gmail.com	Vaidehi
20	Anjali Meshram	8855819748	anjaliMeshram5023@gmail.com	Anjali
21	Ghanashree U. Dhamane	8459807047	ghanashreedhamane@gmail.com	Ghanashree
22	Aarjya S. Hussain	7066411418	hussainarjyas@gmail.com	Ahussain
23	Yachana K. Pandey	9156035297	pandey/kns4@gmail.com	Pandey
24	Rashi Satpute	9763941509	rashisatpute77@gmail.com	Rashi
25	Sakshi Chaudhary	8766352462	Sakshichaudhary111933@gmail.com	Sakshi

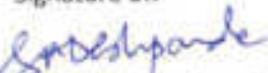
Signature of:

Dr. Shraddha Deshpande
Programme in Charge
Head, Department of English
Dharampeth M.P. Deo Memorial
Science College, Nagpur

COO
INTERNAL QUALITY ASSURANCE CELL
IQAC Coordinator
DHARAMPETH, M. P. DEO MEMORIAL &
SCIENCE COLLEGE, NAGPUR

Principal
Dharampeth M.P. Deo Memorial
Science College, Nagpur.



DHARAMPETH M. P. DEO MEMORIAL SCIENCE COLLEGE,
North Ambazari Road, Near Ambazari Lake, Nagpur- 440033

DATA VALIDATION & VERIFICATION (DVV)

26	Chanchal K. Waghwanis	7796016894	waghwanitara@gmail.com	chanchal
27	Jeet S Pardhi	702025431	jeetspardhi1@gmail.com	
28	Samyak Hadke	7020173304	samyakhadke69@gmail.com	
29	Sejal Kolhe	8483045984	Kothesejal04@gmail.com	
30	AKANSHA TAGDE	8605426387	Tagdeakansha@gmail.com	
31	Kiran ghughuskar	9021231607	ghughuskar.kiran@gmail.com	
32	Mathan M. Todare	8080870430	mathantodare@gmail.com	
33	Pranali Y. Chauhan	9699654562	pranalichauhan69@gmail.com	Pranali
34	Pratiksha M. Meshram	8459070338	meshrampratiksha14@gmail.com	pratiksha
35	Anjali R. Thakre	7066554821	thakreanjur381@gmail.com	Anjali
36	Shamwati Umare	9284249534	shamwati.umare1912@gmail.com	Shamwati
37	Komalika chaudhari	9322033866	KomalikaChaudhari03@gmail.com	
38	Aravj Borikar	9145401746	Aravj.Borikar@gmail.com	
39	Roy Meshram	2529927031	roymeshram@gmail.com	Roy
40	Krutika S. Pokale	9021533341	pokalekrutika6@gmail.com	Kspokale

Signature of:

Programme In-charge
Dr. Shiradha Deshpande
Head, Department
Dharampeth M. P. Deo Memorial
Science College, Nagpur

COORDINATOR
INTERNAL QUALITY ASSURANCE CELL
DHARAMPETH, M. P. DEO MEMORIAL &
SCIENCE COLLEGE, NAGPUR

Principal
Principal
Dharampeth M.P. Deo Memorial
Science College, Nagpur.



DHARAMPETH M. P. DEO MEMORIAL SCIENCE COLLEGE, (poster)
North Ambazari Road, Near Ambazari Lake, Nagpur- 440033

DATA VALIDATION & VERIFICATION (DVV)

1.	Vaidhree B. Gangal	7507907218	gangalvaidhree@gmail.com	Vaidhree
2.	Shrutika G. Pise	9322316336	shrutikapise67@gmail.com	Shrutika
3.	Samiksha D. Shenkar	7420881158	Samikshashenkar08@gmail.com	Samiksha
4.	Pratiksha Y. Boreve	9579936818	Pratikshaboreve49@gmail.com	Pratiksha
5.	Kashish K. Bisen	4887886117	Kashishbisen01@gmail.com	K. Bisen
6.	Bhagyashali D. Neware	779643477	Saltshineware@gmail.com	B.D. Neware
7.	Monali N. Shende	7796516257	Shendemonali@gmail.com	Monali
8.	Muzneeli D. Dilkar	9322427616	muzneeli312@gmail.com	Muzneeli
9.	Sandhya Sahu	9730805235	nehasahu15404@gmail.com	Sandhya
10.	Isha Waghmare	8856319474	Ishuwaghmare9474@gmail.com	Isha
11)	Chetna Buriel	8010342968	burielchetna@gmail.com	Chetna
12)	Nisha Konkaz	9990996645	nishakonkazi@gmail.com	Nisha
13)	Pranali R. Dehankar	8767581278	PranaliR@gmail.com	Pranali R.
14)	Veena Borikar	9322016921	veenaborikar14@gmail.com	Veena
15	Rutika Yadav	8446085943	yadavrutika434@gmail.com	Rutika

Signature of:

Programme In-charge
Dr. Shraddha Deshpande
Head, Department of English
Dharampeth M.P. Deo Memorial
Science College, Nagpur

COORDINATOR
INTERNAL QUALITY ASSURANCE CELL
DHARAMPETH, M. P. DEO MEMORIAL &
SCIENCE COLLEGE, NAGPUR

Principal
Dharampeth M.P. Deo Memorial
Science College, Nagpur.



DHARAMPETH M. P. DEO MEMORIAL SCIENCE COLLEGE,

No. 1 Ambazari Road, Near Ambazari Lake, Nagpur-440033

DATA VALIDATION & VERIFICATION (DVV)

11)	Saurabh Chaudhary	9359883501	schaudhary5599@gmail.com	
12)	Sakshi Chaudhary	9766341962	sakshichaudhary773399	
13)	Katika M. Deshmukh	9699720960	katikamel20@gmail.com	
14)	Siddhi B. Jirani	8084143696	siddhijirani021@gmail.com	
15)	Vidya F. Lohi	7020963219	Vidyalohi8@gmail.com	
16)	Jagriti G. Fulkar	8767911807	Jagritifulkar@gmail.com	
17)	Shivam V. Patel	7038889083	sp040263@gmail.com	shivam
18)	Prachi Chajbhaje	7517259426	prachichajbhaje4967@gmail.com	prachi
19)	Divyani G. Zade	7972403069	divyanizade2005@gmail.com	
20)	Mahima Khare	9545918678	mahimakhare11@gmail.com	
21)	Vaideli Nagalkar	9325963446	Vaideli.nagalkar@gmail.com	
22)	Ankit Patel	9970907638	ankitpatel797275@gmail.com	
23)				
24)				
25)				

Signature of:

Programme In-charge
Dr. Shraddha Deshpande
Head, Department of English
Dharampeth M.P. Deo Memorial
Science College, Nagpur

IQAC Coordinator
IQAC Co-ordinator
Dharampeth M.P. Deo Memorial
Science College, Nagpur-440033

PRINCIPAL
Dharampeth M.P. Deo Memorial
Science College, Nagpur-440033



DHARAMPETH M. P. DEO MEMORIAL SCIENCE COLLEGE,
North Ambazari Road, Near Ambazari Lake, Nagpur- 440033

DATA VALIDATION & VERIFICATION (DVV)

23)	Pradnya Bandu Tirpude	8010362232	pradnyatirpude9145@gmail.com Pradnya
24)	Amal Anand Chaudhary	9529014604	amalchudhary2004@gmail.com Amal Chaudhary
25)	Veena Borikar	9322016921	veenaBORIKAR14@gmail.com Veena
26)	Vaishnavi Namdev Tonge	8421657443	Vaishnavitonge2004@gmail.com Vaishnavi
27)	Janhvi Mahadeo Joge	7385060171	Janhvijoge08@gmail.com Janhvi
28)	Divyanshi Vitthal Zagade	9022866318	divyanshizagade@gmail.com Divyanshi
29)	Pranali R. Dehankar	8767581278	PranaliR11@gmail.com Pranali R. D.
30)	Samiksha A Panchbudhe	9763075590	samikshapanchbudhe363@gmail.com S. Panchbudhe.
31)	Prachi G. Pardhi	7263935912	prachipardhi282@gmail.com P.G.R.
32)	Rutika G. Yadav	8446085949	yadavrutika434@gmail.com Rutika
33)	Aufali Meshram	9767405772	aufalimeshram2023@gmail.com Aufali
34)	Apeksha S. Katangale	7559455794	apekshakatangale26@gmail.com A. Katangale
35)	Varsha L. Turkar	9373650950	varshaturkar487@gmail.com Varsha
36)	Sakshi Mishra	9529889315	Smishra939683@gmail.com Sakshi
37)	Yadnyak Dhage	8623062678	ysdhage0104@gmail.com Y.D.

Signature of

Shraddha Deshpande

Programme In Charge

Dr. Shraddha Deshpande

Head, Department of ...

Dharampeth M. P. Deo Mem.

Amal Chaudhary

Coordinator
Dharampeth M. P. Deo Memorial
Science College, Nagpur-440033

Principals

PRINCIPAL

Dharampeth M.P. Deo Memorial
Science College Nagpur-440033



DHARAMPETH M. P. DEO MEMORIAL SCIENCE COLLEGE,
North Ambazari Road, Near Ambazari Lake, Nagpur- 440033

DATA VALIDATION & VERIFICATION (DVV)

41	Megha Shankar Bhattar	9421728880	meghabhattar@gmail.com	Megha
42	Priyali V. Gupta	7020069377	29991537@gmail.com	Gupta
43	Varsha L. Turkar	9373650950	varshaturkar@gmail.com	Turkar
44	Sakshi Mishra	9529889315	smishra99683@gmail.com	Sakshi
45	Rashi R. Sahpute	9763941509	rashisahpute77@gmail.com	Rashi
46	Divyani Zagade	9022866318	divyani zagade@gmail.com	Divyani
47	Jhanvi H. Larber	8666510539	Jhanvi larber@gmail.com	Jhanvi
48	Jagodi A. Fulkar	8767911307	Jagodi.fulkar@gmail.com	Jagodi
49	Tushal Achare	9075995617	acharetushal@gmail.com	Tushal
50	Samiksha A. Panchbude	9963075890	samikshapanchbude@gmail.com	Samiksha
51	Ved S. Choudhary	7498572768	ved.choudhary.5769@gmail.com	Ved
52	Vedant A. Unethkar	9049932753	unethkarvedant@gmail.com	Vedant
53	Abhiruk R. Singh	8208948107	abhiruk882006@gmail.com	Abhiruk
54	Uday C. Baghele	8453549603	bagheleuday@gmail.com	Uday
55	TANU. H. SINGH	8806355808	tanusingh63492@gmail.com	Tanu

Signature of:

Program In-charge
Head, Department of Education
Dharampeth M.P. Deo Memorial
Science College, Nagpur

CO-ORDINATOR
INTERNAL QUALITY ASSURANCE CELL
DHARAMPETH, M. P. DEO MEMORIAL &
SCIENCE COLLEGE, NAGPUR

Principal
Dharampeth M.P. Deo Memorial
Science College, Nagpur.



DHARAMPETH M. P. DEO MEMORIAL SCIENCE COLLEGE, NAGPUR
INTERNAL QUALITY ASSURANCE CELL (IQAC)

Activity Report

Date: 30th Nov 2022

Name of Organizing Department or Committee: BOTANY DEPARTMENT

Name of the activity: POSTER COMPETATION

Suggested CRITERION point if any: CRITERION-I

Date of Activity: 3rd NOV 2022

Place of Activity: DEPARTMENT OF BOTANY

Name of Guest Speaker/s or Judge/s or Chief Guest/s if any: Prof. Pitambar Humane, Dr. Chandrakumar Patle, Mr. Amol Pimpalshende, Dr. Mrs. Reshma Hiwase, Dr. Mrs. Sweta Rai & Mrs. Dipali Nikure

Title of the Activity: Poster Competition; Economic importance of Cyanobacteria and Algae or Classification of Algae.

Number of Participants: 31

Name of the Teacher In-charge / Convener: Miss- Dipali P. Nikure

Names of other Committee Members / Staff: Dr. Chandrakumar Patle, Mr. Amol Pimpalshende, Dr. Mrs. Reshma Hiwase, Dr. Mrs. Sweta Rai & Mrs. Dipali Nikure

OUTCOME of the Activity with respect to mission vision of the institute and or academics:

Active Participation of Students in preparation of Charts increases their knowledge in the subject. Students tried to use different terminology in preparation of Charts. Different Student created different Charts by their own creativity. This activity helps the students to bring the creativity and innovation in them in the form of posters. The art of poster making was also enhanced due to this activity.

Activity with newspaper coverage if any: NA

Activity data save in PC of: Prof. Pitambar Humane's Laptop

Prof. Pitambar Humane
IQAC Coordinator

CO ORDINATOR
INTERNAL QUALITY ASSURANCE CELL
DHARAMPETH, M. P. DEO MEMORIAL &
SCIENCE COLLEGE, NAGPUR

Dipali P. Nikure

Name & Signature of Teacher In-charge

Dr. Akhilesh Peshwe
Principal

**Dharampeth M. P. Deo Memorial
Science College, Nagpur.**



DHARAMPETH M. P. DEO MEMORIAL SCIENCE COLLEGE,
North Ambazari Road, Near Ambazari Lake, Nagpur- 440033

DATA VALIDATION & VERIFICATION (DVV)

Name of the Programme : Poster competition: Ecological Imp of cyanobacteria & Algae or
Date of the Programme : 3rd Nov 2022 Classification of Algae
Name of Chief Guest if any : _____
Name of Guest Speaker if any : _____

Sr. No.	Name of the Participant	Mobile Number	E-mail Id	Signature
1	Ankasha K. Kholnagade	7972228707	ankashkholnagade7@gmail.com	Ankashi
2	Yachana K. Pandey	9156035297	ypandeykn54@gmail.com	Pandey
3	Aasiya Khatun S. Hussain	7066411418	hussainasiya894@gmail.com	Ahussain
4	Priya B. Sharma	8090764549	priya19012004sharma@gmail.com	Priya
5	Ravindra M. Khachre	8007198273	khachre Ravindra 892@gmail.com	Ravindra
6	Yagita Ramesh Denge	7058437240	yagitadenge@gmail.com	Ramesh
7	Rohan H. Meshram	7499956761	rohmeshram4@gmail.com	Rohanshram
8	Kiran K. Ghughuskar	9021231607	ghughuskar.kiran2004@gmail.com	Kiran
9	Rashi R. Satpute	9763941509	rashisatpute77@gmail.com	Ange
10	Komalika S. Chaudhari	9322033866	Komalika chaudhari073@gmail.com	Komalika

11. Ghanash
Signature of:

[Signature]
Programme In-charge

[Signature]
IQAC Coordinator
COORDINATOR
INTERNAL QUALITY ASSURANCE CELL
DHARAMPETH, M. P. DEO MEMORIAL &
SCIENCE COLLEGE, NAGPUR

[Signature]
Principal
Principal
Dharampeth M.P. Deo Memorial
Science College, Nagpur.



DHARAMPETH M. P. DEO MEMORIAL SCIENCE COLLEGE,
North Ambazari Road, Near Ambazari Lake, Nagpur- 440033

DATA VALIDATION & VERIFICATION (DVV)

11)	ducky A rishwakar md	9579660186	lvvishwakar ²⁹⁰ @gmail.com	<u>Dvishwakar</u>
12)	Amish Askari			
13)	Ashalesha Khadgu			
14)	Sunaina crunchole	8530970132	sunainacrunchole@gmail.com	<u>Schinchole</u>
15)	Samyak Hadke			
16)	Sejal Kolbe	8483045985	KolbeSejal04@gmail.com	<u>Sejal</u>
17)	Ashwini A Langroze	9689117254	langrozeashwinii77@gmail.com	<u>Ashwini</u>
18)	Aarti K. Kharole	9579745628	aartikharole@gmail.com	<u>Aarti</u>
19)	Nitu Rai	7058638984	nitu1419@gmail.com	<u>Nitu</u>
20)	Miya Dhoke	9011681628	miyadhoke1931@gmail.com	<u>Miya</u>
21)	Nisha Pandey	8605231390	abhishet8605231390@gmail.com	<u>Nisha</u>
22)	Maheshwari Bhokare			
23)	Kalyan R. Sindam	8446531622	Kalyanistodhan@gmail.com	
24)	Abhay Tembhare	8975363145	abhay2301@gmail.com	<u>Abhay</u>
25)	Aparna Mohare	7020649887	aparnamohare@gmail.com	<u>Aparna</u>
26)	Apeksha Katangale	75594557894	apekshakatangale@gmail.com	<u>Apeksha</u>
27)	Prerana T. Prasad	9322725293	preranasaut50@gmail.com	<u>Prerana</u>
Signature of:	28) Khushi D. Prasad	9637249032	khushiprasad@gmail.com	<u>Khushi</u>
Programme In-charge	29) Nikita Das	9637249032	Nikitacele907@gmail.com	<u>Nikita</u> Principal
	30) Anvay Borhater	9168538614	anvayborhater.570@gmail.com	<u>Anvay</u>

IQAC Coordinator

Principal



DHARAMPETH M. P. DEO MEMORIAL SCIENCE COLLEGE, NAGPUR

**INTERNAL QUALITY ASSURANCE CELL (IQAC)
Activity Report**

Date:03/11/2022

Name of Organizing Department or Committee: Department of Physics

Name of the activity: NEP based Demonstration Activity for B.Sc. Sem-I

Suggested CRITERION point if any: Restricted to RTMNU BSc physics syllabus.

Date of Activity: 03/11/2022

Place of Activity: Physics laboratory

Name of Guest Speaker/s or Judge/s or Chief Guest/s if any: NA

Title of the Activity: Demonstration of surface tension in different diameter capillaries

Activity with newspaper coverage if any: No

Number of Participants: BSc Sem-I Students – 10

Name of the Teacher In-charge / Convener: Mr. Nikhil Somkule

Names of other Committee Members / Staff: N.A.

OUTCOME of the Activity with respect to academics:

In this demonstration of surface tension, three capillaries of different diameters (0.5 mm, 1.0 mm and 2.0 mm) of same material (glass) were used. All the capillaries were dipped in the same liquid (water) simultaneously and the height of the liquid rise in the capillaries were observed. It was found that the rise of the liquid column was highest in 0.5 mm capillary and lowest in 2.0 mm capillary. The results were in agreement with the Surface tension formula $2T = \rho g r h$.

DVV: Enclosed.

Activity data save in PC of: Lt. Dr. P. W. Ambekar

Prof. Pitambar Humane
IQAC Coordinator
COORDINATOR
INTERNAL QUALITY ASSURANCE CELL
DHARAMPETH, M. P. DEO MEMORIAL &
SCIENCE COLLEGE, NAGPUR

Name & Signature of Teacher In-charge

Dr. Akhilesh Peshwe
Principal
Principal
Dharampeth M.P. Deo Memorial
Science College, Nagpur.



DHARAMPETH M. P. DEO MEMORIAL SCIENCE COLLEGE, NAGPUR

INTERNAL QUALITY ASSURANCE CELL (IQAC)

Activity Report

Date:03/11/2022

Name of Organizing Department or Committee: Department of Physics

Name of the activity: NEP based Demonstration Activity for B.Sc. Sem-I

Suggested CRITERION point if any: Restricted to RTMNU BSc physics syllabus.

Date of Activity: 03/11/2022

Place of Activity: Room no. 004

Name of Guest Speaker/s or Judge/s or Chief Guest/s if any: NA

Title of the Activity: Inductive & capacitive effect on phase of ac source

Activity with newspaper coverage if any: No

Number of Participants: BSc Sem-I Students – 10

Name of the Teacher In-charge / Convener: Mr. Roshan B. Raut

Names of other Committee Members / Staff: N.A.

OUTCOME of the Activity with respect to academics:

This demonstration provided a unique opportunity to BSc Sem-I students to learn the Inductive & capacitive effect on phase of ac source. In this activity a Capacitor and Inductor was connected separately to a power supply. The Capacitive reactance and Inductive reactance were observed in a CRO and Function generator. This demonstration helped students to understand the concept of Inductive & capacitive effect on phase of ac source.

DVV: Enclosed.

Activity data save in PC of: Lt. Dr. P. W. Ambekar

Prof. Pitambar Humane
IQAC Coordinator

CO ORDINATOR
INTERNAL QUALITY ASSURANCE CELL
DHARAMPETH, M. P. DEO MEMORIAL &
SCIENCE COLLEGE, NAGPUR

Name & Signature of Teacher In-charge

Dr. Akhilesh Peshwe
Principal
Principal
Dharampeth M.P. Deo Memorial
Science College, Nagpur.



DHARAMPETH M. P. DEO MEMORIAL SCIENCE COLLEGE, NAGPUR
INTERNAL QUALITY ASSURANCE CELL (IQAC)

Activity Report

Date: 24th Nov 2022

Name of Organizing Department or Committee: BOTANY DEPARTMENT

Name of the activity; -To prepare word puzzles on Microbes (Viruses Mycoplasma and Bacteria)

Suggested CRITERION point if any: CRITERION-I

Date of Activity: 4th NOV 2022

Place of Activity: DEPARTMENT OF BOTANY

Name of Guest Speaker/s or Judge/s or Chief Guest/s if any: NA

Title of the Activity: To prepare word puzzles on Microbes (Viruses Mycoplasma and Bacteria)

Number of Participants: 37

Name of the Teacher In-charge / Convener: Miss- Dipali P. Nikure

Names of other Committee Members / Staff: Dr. Chandrakumar Patle, Mr. Amol Pimpalshende, Dr. Mrs. Reshma Hiwase, Dr. Mrs. Sweta Rai & Mrs. Dipali Nikure

OUTCOME of the Activity with respect to mission vision of the institute and or academics:

Active Participation of Students in preparation of Puzzles increases their knowledge in the subject. Students tried to use different terminology in preparation of puzzles. Different Student created different puzzles by their own creativity. The preparation of word puzzle increases the vocabulary of the subject among students. Also, the students found creative in preparation of word puzzles.

Activity with newspaper coverage if any: NA

Activity data save in PC of: Prof. Pitambar Humane's Laptop

Prof. Pitambar Humane
IQAC Coordinator

CO ORDINATOR
INTERNAL QUALITY ASSURANCE CELL
DHARAMPETH, M. P. DEO MEMORIAL &
SCIENCE COLLEGE, NAGPUR

Dipali P. Nikure.

Name & Signature of Teacher In-charge

Dr. Akhilesh Peshwe
Principal
Principal
Dharampeth M.P. Deo Memorial
Science College, Nagpur.



DHARAMPETH M. P. DEO MEMORIAL SCIENCE COLLEGE,
North Ambazari Road, Near Ambazari Lake, Nagpur- 440033

DATA VALIDATION & VERIFICATION (DVV)

Name of the Programme : to prepare word puzzles on microbes (viruses, Mycoplasma & Bacteria)
 Date of the Programme : 4th Nov 2022
 Name of Chief Guest if any : _____
 Name of Guest Speaker if any : _____

Sr. No.	Name of the Participant	Mobile Number	E-mail Id	Signature
1	Aakrushi K. Khotkhotkar	7972228707	aakrushi.khotkhotkar@gmail.com	<i>Aakrushi</i>
2	Yachana K. Pandey	9156035297	pandeyyachana@gmail.com	<i>Yachana</i>
3	Aarushi Khotkar S. Husain	7066411418	husain.aarushi@gmail.com	<i>Aarushi</i>
4	Prisha Sharma	8010764549	prisha1902004.sharma@gmail.com	<i>Prisha</i>
5	Yagita R. Denge	7058437260	yagitadenge@gmail.com	<i>Yagita</i>
6	Ravindra Phadise	8007198273	ravindra.phadise@gmail.com	<i>Ravindra</i>
7	Rohan Meshram	7499956761	rohan.meshram@gmail.com	<i>Rohan</i>
8	Sanjana S. Tabhane	3699186571	tabhane.sanjana@gmail.com	<i>Sanjana</i>
9	Rashi K. Satpute	9763941508	rashisatpute77@gmail.com	<i>Rashi</i>

Signature of:

Programme In-charge

IQAC Coordinator

COORDINATOR
INTERNAL QUALITY ASSURANCE CELL
DHARAMPETH, M. P. DEO MEMORIAL &
SCIENCE COLLEGE, NAGPUR

Principal
Principal
Dharampeth M. P. Deo Memorial
Science College, Nagpur.



DHARAMPETH M. P. DEO MEMORIAL SCIENCE COLLEGE,
North Ambazari Road, Near Ambazari Lake, Nagpur- 440033

DATA VALIDATION & VERIFICATION (DVV)

10)	Ravindra Khadse.			
11)	Arya Dhoke	9011681628	aryamanuata1331@gmail.com	Arje
13)	Nisha Pandey			
14)	Abhay Tembhere	8975363145	abhay230102@gmail.com	Abhay
15)	Anjali Thakre	7066554821	thakreanjy381@gmail.com	Anjali
16)	Nishi B. Rai	7058638784	r.nishi1412@gmail.com	Nishi
17)	Lucky A Vishwakarma	9579660186	lvishwakarma@gmail.com	Lucky Vishwakarma
18)	Aarti K. Kharole	9578795628	aartikhadole@gmail.com	Aarti
19)	Ashwini A. Lanjewar	968011754	lanjewarshwini777@gmail.com	Ashwini
20)	Khushi J. Bhandari	9606367894	zanskhushibhandari@gmail.com	Khushi
21)	Peeyanshu T. Raut	9322725233	peeyanshukaut56@gmail.com	Peeyanshu
22)	Rohan H. Meshram	7499956761	Rohan Meshram	Rohan
23)	Khushi Prasad	9637249032	khushiprasad31	Khushi
24)	Nikita Das	8446297886	Nikitadas907@gmail.com	Nikita
25)	Sagar D. Kolhe	8483045985	kolhasyatal04@gmail.com	Sagar
26)	Anvay B. Borkar	9168539614	anvayborkar400@gmail.com	Anvay

Signature of:

Programme In-charge

IQAC Coordinator

CO ORDINATOR
INTERNAL QUALITY ASSURANCE CELL
DHARAMPETH, M. P. DEO MEMORIAL &
SCIENCE COLLEGE, NAGPUR

Principal

Principal
Dharampeth M.P. Deo Memorial
Science College, Nagpur.



DHARAMPETH M. P. DEO MEMORIAL SCIENCE COLLEGE,
North Ambazari Road, Near Ambazari Lake, Nagpur- 440033

DATA VALIDATION & VERIFICATION (DVV)

27)	Aparna Mohare	7020649887	oparnamohare23@gmail.com	Aparna
28)	Anshul Y. Kinnapure	9284067169	anshulkinnapure65@gmail.com	Anshul
29)	Anjali Thakre	7066554821	Anjalithakre@gmail.com	Anjali
30)	Komalika Chaudhari	9322033866	KomalikaChaudhari573@gmail.com	Komalika
31)	Yogita Denge.	7058437240	yogitadenge@gmail.com	YDenge
32)	Vaishnavi Denge.	8421657943	VaishnaviDenge2004@gmail.com	Vaishnavi
33)	Apelash Kistangale	7559955794	ApelashKistangale@gmail.com	Apelash
34)	Nisha Pandey	8605231390	nbishk8605231390@gmail.com	Nisha
35)	Yachana K. Pandey	9156075297	pandeykns4@gmail.com	Yachana
36)	Priya B. Sharma	8010784543	priya19012004@gmail.com	Priya
37)	Ghanashree U. Dhemare	8459807647	ghanashreedhemare@gmail.com	Ghanashree

Signature of:

Programme In-charge

COORDINATOR
INTERNAL QUALITY ASSURANCE CELL
DHARAMPETH, M. P. DEO MEMORIAL &
SCIENCE COLLEGE, NAGPUR

Principal
Principal
Dharampeth M.P. Deo Memorial
Science College, Nagpur.



INTERNAL QUALITY ASSURANCE CELL (IQAC)

Activity Report

Date: 04/11/2022

Name of Organizing Department or Committee: Department of Physics

Name of the activity: NEP based Demonstration Activity for B.Sc. Sem-V

Suggested CRITERION point if any: Restricted to RTMNU BSc physics syllabus.

Date of Activity: 04/11/2022

Place of Activity: Room no. 004

Name of Guest Speaker/s or Judge/s or Chief Guest/s if any: NA

Title of the Activity: Demonstration Finding most probable and average height of students in the class

Activity with newspaper coverage if any: No

Number of Participants: BSc Sem-V Students-21

Name of the Teacher In-charge / Convener: Mr. Nishant Zode

Names of other Committee Members / Staff: N.A.

OUTCOME of the Activity with respect to academics:

BSc Sem-V students were made to learn the phenomenon finding most probable and average height of students in the class. To relate how average speed behaviour of ideal in KTG we demonstrated student how find average by simple measuring their height and finding average height. Also comparing how many student have same approximate height and called it as Most probable height

DVV: Enclosed.

Activity data save in PC of: Lt. Dr. P. W. Ambekar

Prof. Pitambar Humane
IQAC Coordinator

CO ORDINATOR
INTERNAL QUALITY ASSURANCE CELL
DHARAMPETH, M. P. DEO MEMORIAL &
SCIENCE COLLEGE, NAGPUR

Name & Signature of Teacher In-charge
DEPARTMENT OF PHYSICS
Dharampeth M. P. Deo Memorial
Science College, Nagpur

Dr. Akhilesh Peshwe
Principal

Principal
Dharampeth M.P. Deo Memorial
Science College, Nagpur.

**DHARAMPETH M. P. DEO MEMORIAL SCIENCE COLLEGE NAGPUR****Department of Physics**

Class: B.Sc. Sem.-V

NEP ACTIVITY

Paper- I

Unit- III

Name of the Teacher: Nishant ZodeDate: 04/11/2022Title of Activity: Finding most probable and average height of student in class

Sr. No.	Name of Student	Batch	Mobile No.	Email ID	Signature
1	Sakshi Moon	T-10	7745827736	sakshim@gmail.com	
2	Muskan Sheikh	T-9	8055474633	Muskan2019sss@gmail.com	
3	Shivani Bhute	T-10	930290209	bhuteshivan83@gmail.com	
4	Frachi S. Waghule	T-8	8767914118	Frachiwaghule21@gmail.com	
5	Damini M. Bandbuche	T-7	827105785	bandbuchedomini@gmail.com	
6	Raji. N. Pathan	T-9	8669595198	rajiknang66@gmail.com	
7	Rani D. Patel	T-9	7888241794	Ranipatel5515@gmail.com	
8	Aakash. Ashok. Silcalay	T-10	9175422057	SPKdauakash@gmail.com	
9	Tannay Bhute	T-10	7697250831	tannaybhute900@gmail.com	
10	Shivam Manjari	T-8	960787302	shivammanjari12911@gmail.com	
11	Pragya Sna	T-8	966885296	pragya@gmail.com	
12	Chaitale kumbade	T-8	9359540741	chaitale@gmail.com	
13	Pratiksha Umare	T-3	9359175006	Pratikshakumare56@gmail.com	
14	Suhriya Patle	T-7	7767871925	Patlesuhriya@gmail.com	
15	Ashwini Suresh	T-9	808731727	ashwinisuresh@gmail.com	
16	Ankita Sonwane	T-3	87280492	ankitasonwane@gmail.com	
17	Megha Bisen	T-3	751795926	meghabisen@gmail.com	
18	Kiran Waghade	T-3	932584536	Kiranwaghade@gmail.com	
19	Pallavi Y. Bhugat	T-10	9022654940	Pallavi02208@gmail.com	
20	Anshuman Sharma	T-8	937089246	anshuman93@gmail.com	
21	Chetan Kauthe	T-7	9657271601	chetan@gmail.com	

NZode

Signature of Teacher

NZodeDEPARTMENT OF PHYSICS
Dharampeth M. P. Deo Memorial
Science College, Nagpur



**DHARAMPETH M. P. DEO MEMORIAL SCIENCE COLLEGE, NAGPUR
INTERNAL QUALITY ASSURANCE CELL (IQAC)**

Activity Report

Date: 5/11/22

Name of Organizing Department or Committee: Department of Home-Science

Name of the activity: _Balwadi Visit

Suggested CRITERION point if any: II

Date of Activity: 5.11.22

Place of Activity: Gandtoli, Ramnagar, Nagpur.

Name of Guest Speaker/s or Judge/s or Chief Guest/s if any:

Title of the Activity: Visit to Balwadi

Number of Participants: 18

Name of the Teacher In-charge / Convener: M.M. Deshpande & DR. Manda Walokar

Names of other Committee Members / Staff: Entire Staff OF Home Science

OUTCOME of the Activity with respect to mission vision of the institute and or academics:

Student learn to participate with School Children, teach them songs, rhymes, Stories Syllabus related activities.

Activity with newspaper coverage if any: No

Activity data save in PC of:

Note: Kindly share geotag photographs separately along with report on igacdsc2022@gmail.com



M. M. Deshpande
Name & Signature of Teacher In-charge

Pitambar Humane
Prof. Pitambar Humane
IQAC Coordinator
CO-ORDINATOR
INTERNAL QUALITY ASSURANCE CELL
DHARAMPETH, M. P. DEO MEMORIAL &
SCIENCE COLLEGE, NAGPUR

Akhillesh Peshwe
Dr. Akhillesh Peshwe
Principal
PRINCIPAL
Dharampeth M. P. Deo Memorial
Science College, Nagpur-440033

To
The Principal,
Dharampeth M.P. Deo Memorial Science College,
Ambazari, Nagpur

Subject: Application for permission to visit Aanganwadi center

Respected sir,

I, Dr. Manda Walokar, CHB (Home Science Department) request you to permit to visit the Aanganwadi center situated at Ram Nagar, near our college on dated 5 Nov. 2022 at 12:30 P.M. along with the student of B.Sc home science semester 3 and 5, as this activity is a part of our syllabus, which will be beneficial to our students in future.

I hope you would provide your utmost consideration to your request.

Thanking you,

Yours sincerely,

Neelipande
HOD, Home Science

Chatur
PRINCIPAL
DHARAMPETH M.P. DEO
MEMORIAL SCIENCE COLLEGE
NAGPUR

Chatur

visit to Aganwadi Centre



DHARAMPETH M. P. DEO MEMORIAL SCIENCE COLLEGE,
North Ambazari Road, Near Ambazari Lake, Nagpur- 440033

DATA VALIDATION & VERIFICATION (DVV)

Sl. NO	students Name	Mail ID	Phone Number	Signature
1.	Pragya S. Tiwari	Pragyatiwari14052008@gmail.com	6394098386	
2.	ojasvi M. Wankhede	wankhedojasvi@gmail.com	8767697751	
3.	Priya K. Khawshi	priyakhawshi@gmail.com	9768617224	
4.	Kpmayo .N Kale	kpmayakale003@gmail.com	8866073792	
5.	Archita A. Maske	maskearchita@gmail.com	9975034151	
6.	Bhagyashree S. Ambule	ambuleb@gmail.com	9359139068	
7.	Vaishnavi K. Pradhan	pradhanvaisnavi157@gmail.com	9763169560	
8.	Gujata V. Kaulke	sujatakaulke1@gmail.com	9175451202	
9.	Shrushti Patekar	shrushtipatekar@gmail.com	7987067403	
10)	Pallavi B. Katre	Pkatre573@gmail.com	8459277408	
11)	Bharti G. Harne	bhartiharne@gmail.com	7057791959	
12)	Deepika R. Julekar	dgr596025@gmail.com	9790994644	
13)	Tanner S. Korde	kordetanner0139@gmail.com	7841384450	

Signature of:

Programme In-charge

CO-ORDINATOR
INTERNAL QUALITY ASSURANCE CELL
DHARAMPETH, M. P. DEO MEMORIAL &
SCIENCE COLLEGE, NAGPUR

Principal

Sem - 12
5/11/2024

Visit to Aganwadi Centre



DHARAMPETH M. P. DEO MEMORIAL SCIENCE COLLEGE,
North Ambazari Road, Near Ambazari Lake, Nagpur - 440033

DATA VALIDATION & VERIFICATION (DVV)

1.	Sushmita Mallick	9884916560	sushmittk00@gmail.com	Sushmita
2.	Aashi Ramteke	8983345716	aashiramteke7@gmail.com	Ramteke
3.	Aarti Raut	8625813184	araut@gmail.com	ARaut
4.	Mahima Inamkhede	7821883251	mahima.inamkhede@gmail.com	Mahima
6.	Vaughika & Talase	9488118928	Vaughika@gmail.com	vaughika
7.	Ananya A Meghre	9284834439	Ananyameghre@gmail.com	Ananya

Signature of:
M. S. Dalakam
Programme In-charge

M. S. Dalakam

[Signature]
CO ORDINATOR
IQAC Coordinator
INTERNAL QUALITY ASSURANCE CELL
DHARAMPETH, M. P. DEO MEMORIAL &
SCIENCE COLLEGE NAGPUR

[Signature]
Principal

Dharampeth M. P. Deo Memorial
Science College, Nagpur-440033



DHARAMPETH M. P. DEO MEMORIAL SCIENCE COLLEGE, NAGPUR
INTERNAL QUALITY ASSURANCE CELL (IQAC)

Activity Report

Date: 25th Nov 2022

Name of Organizing Department or Committee: BOTANY DEPARTMENT

Name of the activity: Collection of Algal Members

Suggested CRITERION point if any: CRITERION-I

Date of Activity: 5 NOV 2022

Place of Activity: College Campus

Name of Guest Speaker/s or Judge/s or Chief Guest/s if any: NA

Title of the Activity: To Collect, Identify and describe some common Algal Members found in and around college campus or residence.

Number of Participants: 26

Name of the Teacher In-charge / Convener: Miss- Dipali P. Nikure

Names of other Committee Members / Staff: Dr. Chandrakumar Patle, Mr. Amol Pimpalshende, Dr. Mrs. Reshma Hiwase, Dr. Mrs. Sweta Rai & Mrs. Dipali Nikure

OUTCOME of the Activity with respect to mission vision of the institute and or academics:

Active Participation of Students in Collection of different Algal Members increases their knowledge in the subject and identification of Algal members. Students search on different places which also increases knowledge. The student became aware about the different algal members in their residence area. This will also help to identify the presence of different algal members in different water bodies nearby areas of the city.

Activity with newspaper coverage if any: NA

Activity data save in PC of: Prof. Pitambar Humane's Laptop

Prof. Pitambar Humane
IQAC Coordinator

CO ORDINATOR
INTERNAL QUALITY ASSURANCE CELL
DHARAMPETH, M. P. DEO MEMORIAL &
SCIENCE COLLEGE, NAGPUR

Dipali P. Nikure.

Name & Signature of Teacher In-charge

Dr. Akhilesh Peshwe
Principal
Principal
Dharampath M.P. Deo Memorial
Science College, Nagpur.



DHARAMPETH M. P. DEO MEMORIAL SCIENCE COLLEGE,
North Ambazari Road, Near Ambazari Lake, Nagpur- 440033

DATA VALIDATION & VERIFICATION (DVV)

Name of the Programme : To collect, identify & describe some common fungal members found in other college

Date of the Programme : 5th Nov 2022

Name of Chief Guest if any : _____

Name of Guest Speaker if any : _____

Sr. No.	Name of the Participant	Mobile Number	E-mail Id	Signature
1	Ankusha. K. Khotekar	7972228707	ankushakhotekar@gmail.com	Ankusha
2	Arshita Khotkar. S. Hiranjan	7066411418	huranjanofjessie@gmail.com	Arshita
3	Yachana K. Pandey	9156035297	pandeyken54@gmail.com	Pandey
4	Priya B. Sharma	8010764549	priya19012004@gmail.com	Sharma
5	Rohan H. Meshram	7499956761	rohanmeshram49@gmail.com	Rohan
6	Sanjana .S. Tabbane	9699186571	tabbanesanjana@gmail.com	Sanjana
7	Ravindra Khadse	8007178273	khadseravindra842@gmail.com	Khadse
8	Nitesh B. Rai	7058638984	nitesh1419@gmail.com	Nitesh
9	Abhay P. Tembhare	8975363145	abhay23012@gmail.com	Abhay
10	Rashi R. Satpute	9763941509	rashisatpute77@gmail.com	Rashi

Signature of:

Programme in-charge

IQAC Coordinator
COORDINATOR
INTERNAL QUALITY ASSURANCE CELL
DHARAMPETH, M. P. DEO MEMORIAL &
SCIENCE COLLEGE, NAGPUR

Principal
Principal
Dharampeth M.P. Deo Memorial
Science College, Nagpur.



DHARAMPETH M. P. DEO MEMORIAL SCIENCE COLLEGE,
North Ambazari Road, Near Ambazari Lake, Nagpur- 440033

DATA VALIDATION & VERIFICATION (DVV)

11.	Komalika .S. Chaudhari	9322033866	Komalikachaudhari073@gmail.com	
12	Lucky A. Vishwakarma			
13	Aparna Mohare	7020649887	aparnamohare@gmail.com	Aparna
14	Arya Dhoke	901168628	aryamanvata@gmail.com	Arya
15)	Anjali Thakre	7066554821	thakreanju381@gmail.com	Anjali
16)	Vaishnavi N Tonge	8421657443	Vaishnavitonge2000@gmail.com	Vaishnavi
17)	Anshul Y. Kinapure	9284067169	anshulkinapure650@gmail.com	Anshul
18)	Lucky A Vishwakarma	9579660186	Lvishwakarma240@gmail.com	Lvishwakarma
19)	Prayanshu T. Raut	9322725233	PrayanshuRaut50@gmail.com	Prayanshu
20)	Khuski S. Bhanu	9604367894	2003khuski@gmail.com	Khuski
21)	Nisha Pandey	8605231590	abhishta8605231590@gmail.com	Nisha
22)	Khuski Prasad	9637249092	khuskiprasad31@gmail.com	Khuski
23)	Nikita Das	84416297880	Nikitadas9079@gmail.com	Nikita
24)	Sefal Kolhe	8483045985	Kolhesefal04@gmail.com	Sefal
25)	Anvay Borkar	9165538614	anvayborkar520@gmail.com	Anvay
26)	Ghanashree U. Dhore	8459807047	ghanashreedhore@gmail.com	Ghanashree

Signature of:

Programme In-charge

IQAC Coordinator

COORDINATOR
INTERNAL QUALITY ASSURANCE CELL
DHARAMPETH, M. P. DEO MEMORIAL &
SCIENCE COLLEGE, NAGPUR

Principal
Principal
Dharampeth M.P. Deo Memorial
Science College, Nagpur.



DHARAMPETH M. P. DEO MEMORIAL SCIENCE COLLEGE, NAGPUR
INTERNAL QUALITY ASSURANCE CELL (IQAC)

Activity Report

Date: 25th Nov 2022

Name of Organizing Department or Committee: BOTANY DEPARTMENT

Name of the activity: To Study Biofertilizers commonly used by Farmers.

Suggested CRITERION point if any: CRITERION-I

Date of Activity: 5th NOV 2022

Place of Activity: DEPARTMENT OF BOTANY

Name of Guest Speaker/s or Judge/s or Chief Guest/s if any: NA

Title of the Activity: To Study Biofertilizers commonly used by Farmers

Number of Participants: 18

Name of the Teacher In-charge / Convener: Miss- Dipali P. Nikure

Names of other Committee Members / Staff: Dr. Chandrakumar Patle, Mr. Amol Pimpalshende, Dr. Mrs. Reshma Hiwase, Dr. Mrs. Sweta Rai & Mrs. Dipali Nikure

OUTCOME of the Activity with respect to mission vision of the institute and or academics:

Active Participation of Students on making Reports on Biofertilizers by Searching Biofertilizers Names and uses increases their knowledge in the subject. Students also individually contact farmers and collect information from them also enhance their knowledge. The change in atmosphere is due to use of chemical fertilizers, hence, it is important to spread the awareness to use the biofertilizer to avoid soil and water pollution.

Activity with newspaper coverage if any: NA

Activity data save in PC of: Prof. Pitambar Humane's Laptop

Prof. Pitambar Humane
IQAC Coordinator

CO ORDINATOR
INTERNAL QUALITY ASSURANCE CELL
DHARAMPETH, M. P. DEO MEMORIAL &
SCIENCE COLLEGE, NAGPUR

Dipali P. Nikure,

Name & Signature of Teacher In-charge

Dr. Achillesh Peshwe
Principal
Principal
Dharampeth M.P. Deo Memorial
Science College, Nagpur.



DHARAMPETH M. P. DEO MEMORIAL SCIENCE COLLEGE,
North Ambazari Road, Near Ambazari Lake, Nagpur- 440033

DATA VALIDATION & VERIFICATION (DVV)

Name of the Programme : To study Biofertilizer commonly used by farmer.
Date of the Programme : 5th Nov 2022
Name of Chief Guest if any : _____
Name of Guest Speaker if any : _____

Sr. No.	Name of the Participant	Mobile Number	E-mail Id	Signature
1	Ravindra M. Khadse	8007198273	khadse.ravindra842@gmail.com	
2	Yagita R. Denge	7058439240	yagitadenge@gmail.com	
3	Sanjana S. Tabhane	9699186571	tabhanesanjana@gmail.com	
4	Rashi P. Salpute	9763941509	rashisalpute77@gmail.com	
5	Lucky A. Vishwakarma	9579660186	luckyvishwakarma@gmail.com	
6	Nitu Rai	7058628984	nitu1414@gmail.com	
7	Syjal Kohre			
8	Arya Bhojke	901681628	arya.harmata1331@gmail.com	
9	Abhay Tembhare	8975363145	abhay230102@gmail.com	
10	Aparna Mahare	7020649987	apannamahare@gmail.com	

Signature of:

Programme In-charge

IQAC COORDINATOR
INTERNAL QUALITY ASSURANCE CELL
DHARAMPETH, M. P. DEO MEMORIAL &
SCIENCE COLLEGE, NAGPUR

Principal
Principal
Dharampeth M. P. Deo Memorial
Science College, Nagpur.



DHARAMPETH M. P. DEO MEMORIAL SCIENCE COLLEGE,
North Ambazari Road, Near Ambazari Lake, Nagpur- 440033

DATA VALIDATION & VERIFICATION (DVV)

11)	Sakshi . S choudhary	8766852462	Sakshichoudhary11111@gmail.com	Sakshi
12)	Ghanashree. U. Dhokane	8459804649	Ghanashreedhokane@gmail.com	Ghanashree
13)	Manthan .M. Todase	880870630	manthan.todase@gmail.com	Manthan
14)	Aarti k. kharole	9579745628	aartikharole@gmail.com	Aarti
15)	Ashwini A. lanjewar	868911754	lanjewarashwini@gmail.com	Ashwini
16)	Sunaina p. chichonde	8530970132	sunainachichonde123@gmail.com	Sunaina
17)	Tanu Dhawale	8459543857	Tanudhawale7@gmail.com	Tanu
18)	Riya . A. Singh	9595649831	riyas2307@gmail.com	Riya

Signature of:

Programme In-charge

CO-ORDINATOR
INTERNAL QUALITY ASSURANCE CELL
DHARAMPETH, M. P. DEO MEMORIAL &
SCIENCE COLLEGE, NAGPUR

Principal
Principal
Dharampeth M.P. Deo Memorial
Science College, Nagpur.



INTERNAL QUALITY ASSURANCE CELL (IQAC)

Activity Report

Date: 7/11/2022

Name of Organizing Department or Committee: Department of Mathematics

Name of the activity: NEP based find the application of First-order Differential Equations to Real World Systems for B.Sc. Semester-III

Suggested CRITERION point if any: Criterion I.

Date of Activity: 5/11/2022

Place of Activity: Class room

Name of Guest Speaker/s or Judge/s or Chief Guest/s if any: NA

Title of the Activity: Find the application of First-order Differential Equations to Real World Systems

Activity with newspaper coverage if any: No

Number of Participants: B.Sc. Semester-III Students

Name of the Teacher In-charge / Convener: Dr. N. P. Gaikwad (42)

Names of other Committee Members / Staff: N.A.

OUTCOME of the Activity with respect to academics:

This activity provided an opportunity to B.Sc. Semester-III students to application of First-order Differential Equations to Real World Systems. In this activity, involves the derivative of a function or a dependent variable with respect to an independent variable. **Population growth, spring vibration, heat flow, radioactive decay** can be represented using a differential equation.

This activity helped students to understand the concept of application of First-order Differential Equations to Real World Systems.

DVV: Enclosed

Dr. N. P. Gaikwad
Name & Signature of Teacher In-charge



Prof. Pitambar Humane

IQAC Coordinator

CO ORDINATOR
INTERNAL QUALITY ASSURANCE CELL
DHARAMPETH, M. P. DEO MEMORIAL &
SCIENCE COLLEGE, NAGPUR



Dr. Akhilesh Peshwe

Principal

Principal
Dharampeth M.P. Deo Memorial
Science College, Nagpur.



DHARAMPETH M. P. DEO MEMORIAL SCIENCE COLLEGE,
North Ambazari Road, Near Ambazari Lake, Nagpur- 440033

DATA VALIDATION & VERIFICATION (DVV)

Name of the Programme : Find the application of first order diff. eqⁿ to Real world system
Date of the Programme : 05/11/2022
Name of Chief Guest if any : —
Name of Guest Speaker if any : —

Sr. No.	Name of the Participant	Mobile Number	E-mail Id	Signature
1)	Devang. Kasra	7888238500	ladddudevong@gmail.com	
2)	Sejal. R. Lakhanpal	9028851568	Sejallakhanpal@gmail.com	
3)	Prachi. R. Koppalwar	7498102097	Prachikoppalwar@gmail.com	
4)	Kajal P. Nighot	9373250623	Kajunighot2@gmail.com	
5)	Shital R. Ketzake	9373389723	shital202pk@gmail.com	
6)	Nikita J. Kalla	9067324988	kallonikita54@gmail.com	
7)	Aasmin. K. Sheikh	8668323588	aasmin5029@gmail.com	
8)	Aditya Kumar Singh	7350543901	adityasingh282180@gmail.com	
9)	Dinesh J. Parteti	9623389676	partetidinesh51@gmail.com	
10)	Vicky. A. Singh	9834782931	vickysingh1032001@gmail.com	
11)	Yash. R. Bhedekar	7020829422	yashbhedekar@gmail.com	
12)	Chetan V. Bopche	9172484828	Chetanbopch27@gmail.com	

Programme In-charge

IQAC Coordinator

Principal

Dharampeth M.P. Deo Memorial
Science College, Nagpur.



DHARAMPETH M. P. DEO MEMORIAL SCIENCE COLLEGE,
North Ambazari Road, Near Ambazari Lake, Nagpur- 440033

DATA VALIDATION & VERIFICATION (DVV)

13]	Rahul . R. Kawade	9359525716	KawadeRahul04@gmail.com	R Kawade
14]	Ketan S. Bhojar	9657957296	Ketanbhojar55@gmail.com	K Bhojar
15]	Harshal Ajankar	9527732348	HarshalAjankar8@gmail.com	H. N. Harshal
16]	Isha Nemade	7028494761	IshaNemade72@gmail.com	Isha
17]	Kajal Prasad	7410763138	prasadkajal2004@gmail.com	K Prasad
18)	Bhagyawathi Patil Pandey	9175302601	pandeybhagyawathi@gmail.com	Pandey
19)	Shweta Bedwal	9080440184	shwetabedwal2005@gmail.com	shweta
20)	Rital Bisen	7029810940	ritalbisen06@gmail.com	Rital
21)	Mansi Nandawar	7709322027	mansinandawar@gmail.com	M Nandawar
22)	Aditya Kumar Singh	7350543961	adityaSingh288180@gmail.com	A. K. S
23]	Dinash . I. Paroteti	8623389676	ParotetiDinash51@gmail.com	Din
24)	Vicky . A. Singh	9834782931	vickySingh11072001@gmail.com	Vicky
25]	Somit Sable	9322410388	SomitSable1250@gmail.com	Somit
26]	Vrushali K. Shahare	9307516332	Vrushalishahare25@gmail.com	V K Shahare
27)	Sarthak Jichkar	8605710878	sarthakjichkar@gmail.com	Sarthak
28)	Sanchit . S. Patil .	7818079074	sanchitapatil18003@gmail.com	Sanchit
29)	Damini Katre .	8208255685	daminikatre31@gmail.com	Damini
30)	Aditi Lute .	7820212803	aditilute191@gmail.com	Aditi
31	Kunal S Digrave	8010274303	kunaldigrave@gmail.com	Kunal

Programme in-charge

IQAC Coordinator
IQAC Co-ordinator

Dharampeth M.P. Deo Memorial
Science College, Nagpur-440033

Principal
Principal
Dharampeth M.P. Deo Memorial
Science College, Nagpur.



DHARAMPETH M. P. DEO MEMORIAL SCIENCE COLLEGE,
North Ambazari Road, Near Ambazari Lake, Nagpur- 440033

DATA VALIDATION & VERIFICATION (DVV)

32	Ritik M. Varma	9356744234	ritik.v.29@gmail.com	R. Varma
33	Ritik V. Gajbhiye	7520826960	ritik.gajbhiye.05@gmail.com	Rit
34	Jasraj D. Paliwal	9370820325	jasraj.paliwal.47@gmail.com	J.P.
35	Amanya Motghare	7219218955	amanya.motghare@gmail.com	A
36	Jay A. Patil	7385436956	Jay.Patil0326@gmail.com	Jay
37	Divya Hanote	8605422901	divyahanote0406@gmail.com	Divya
38	Kavita Mishra	9657199261		Aishwarya
39	Rupur Sharma	9322042259	rupursharma258@gmail.com	Rupur
40	Aditya Kumar Singh ^{Shukla}	9518994638	adityashukla0025@gmail.com	Aditya
41	Pradumana Singh	7666939940	pradumana.singh@gmail.com	P
42	Nitin Kushwaha	9693429005	nitinkushwaha07@gmail.com	Nitin
43	Ananya Motghare	7219218955	ananya.motghare@gmail.com	A
44	Hitesh G. Kawase	7058427112	hitesh.kawase.73@gmail.com	Hitesh
45	Reshmi Lande	7719952401	reshmi.lande.220@gmail.com	Reshmi
40	Vaishnavi Tulekar	9156916355	v70806893@gmail.com	Vaishnavi
41	Gaurav Lande	7767854087	gaurav.lande5421@gmail.com	Gaurav
42	Akshay Khondare	7350856109	akshay.khondare79@gmail.com	Akshay

Signature of:

Programme In-charge

IQAC Coordinator
IQAC Co-ordinator
Dharampeth M. P. Deo Memorial
Science College, Nagpur-440033

Principal
Dharampeth M. P. Deo Memorial
Science College, Nagpur.



DHARAMPETH M. P. DEO MEMORIAL SCIENCE COLLEGE, NAGPUR

INTERNAL QUALITY ASSURANCE CELL (IQAC)

Activity Report

Date: 5th November 2022

Name of Organizing Department or Committee: Electronics Department
Name of the Activity : Solving, minimizing and verifying Boolean equations using K-map
Suggested CRITERION point if any: Suggested criteria II
Date of Activity: 5th November 2022
Place of Activity : Electronics Lab

Name of Guest Speaker/s or Judge/s or Chief Guest/s if any : Not applicable

Title of the Activity: Solving, minimizing and verifying Boolean equations using K-map
Based on Unit : 3(Paper 2)
Class : Semester I
Number of Participants: 17

Name of the Teacher In-charge / Convener: Prof. V. V. Rangari

OUTCOME of the Activity with respect to mission vision of the institute and or academics:

Students know how to use K-map. Students know how to minimize the Boolean equation using K-map.

Prof. V. V. Rangari

Head of the Department



Prof. Pitambar Humane

CO ORDINATOR

**INTERNAL QUALITY ASSURANCE CELL
DHARAMPETH, M. P. DEO MEMORIAL &
SCIENCE COLLEGE, NAGPUR**

Dr. Akhilesh Peshwe

Principal
Dharampeth M.P. Deo Memorial
Science College, Nagpur.



DHARAMPETH M. P. DEO MEMORIAL SCIENCE COLLEGE, NAGPUR

Department of Electronics

Semester I- (2022-23)

Activity (Paper II - Unit- 3)

Sr. No.	Student Name	Mobile Number	Email ID
1	Sandeep Rakesh Kumar Kumar	8081144948	sandeepk27900@gmail.com
2	Vedant Onkar Umretkar	9049932753	umretkarvedant@gmail.com
3	Tushal Rupkumar Achare	9075995617	acharetushal5@gmail.com
4	Ved Sudhir Choudhary	7498572766	vedchoudhary.cs.749@gmail.com
5	Abhishek Ravindra Singh	8208948107	abhi0882005@gmail.com
6	Khushbu Rajiv Pali	8459565214	palikhushbu59@gmail.com
7	Khushi Rajiv Pali	8767607224	palikhushi4@gmail.com
8	Harshata Gunderao Warkhede	9860432428	bandukeshao20@gmail.com
9	Vaidhavi Baburao Gongal	7507907278	gayatrigongal787@gmail.com
10	Simran Narendra Dhimole	8390347026	mishralaxmi210@gmail.com
11	Tanu Ajay Singh	8806355808	tanusingh63492@gmail.com
12	Aniket Jayram Bawankar	9322804484	adityabawankar9@gmail.com
13	Tejas Rajesh Chelmeelwar	9604662119	tejaschelmeelwar@gmail.com
14	Aayushi Vikram Singh	9595119942	senxerox04@gmail.com
15	Isha Ishwar Waghmare	8855919474	ishawaghmare9474@gmail.com
16	Bhagyashali Dadarao Neware	7796434177	sakshineware2017@gmail.com
17	Uday Chandrashekhar Baghele	8459549609	bagheleuday@gmail.com

Name & Signature of Teacher In-Charge

Prof. Pitambar Humane
IQAC Coordinator

CO ORDINATOR

INTERNAL QUALITY ASSURANCE CELL
DHARAMPETH, M. P. DEO MEMORIAL &
SCIENCE COLLEGE, NAGPUR

Name & Signature of Head of the
Department

Dr. Varsha V. Rang
Professor & Head
Department of Electrc
Dharampeth M.P. Deo Mem
Science College, Nagpur

Dr. Akhilesh Peshwe
Principal

Principal
Dharampeth M.P. Deo Memorial
Science College, Nagpur.



DHARAMPETH M. P. DEO MEMORIAL SCIENCE COLLEGE, NAGPUR

INTERNAL QUALITY ASSURANCE CELL (IQAC)

Activity Report

Date: 05/11/2022

Name of Organizing Department or Committee: Department of Physics

Name of the activity: NEP based Demonstration Activity for B.Sc. Semester-III

Suggested CRITERION point if any: Restricted to RTMNU B.Sc. physics syllabus.

Date of Activity: 05/11/2022

Place of Activity: Room no. 003

Name of Guest Speaker/s or Judge/s or Chief Guest/s if any: NA

Title of the Activity: Demonstration on diffraction using blade & laser.

Activity with newspaper coverage if any: No

Number of Participants: B.Sc. Semester-III Students - 50

Name of the Teacher In-charge / Convener: Ms. Amrapali K. Meshram

Names of other Committee Members / Staff: N.A.

OUTCOME of the Activity with respect to academics:

This demonstration provided a unique opportunity to B.Sc. Semester-III students to learn the phenomenon of diffraction. In this activity, took two blades which fixed in potato & put it in black background, the gap between these blades much smaller than 1 mm. passed the laser beam on it through slit, diffraction pattern identified by alternate dark & bright bands. This demonstration helped students to understand the concept of optical phenomenon diffraction.

DVV: Enclosed.

Activity data save in PC of: Lt. Dr. P. W. Ambekar

Prof. Pitambar Humane
IQAC Coordinator

CO ORDINATOR
INTERNAL QUALITY ASSURANCE CELL
DHARAMPETH, M. P. DEO MEMORIAL &
SCIENCE COLLEGE, NAGPUR

Name & Signature of Teacher In-charge

Dr. Akhilesh Peshwe
Principal
Principal
Dharampeth M.P. Deo Memorial
Science College, Nagpur.



DHARAMPETH M. P. DEO MEMORIAL SCIENCE COLLEGE NAGPUR

Department of Physics

Class: B.Sc. Sem.-III

NEP ACTIVITY

Paper-2

Unit-II

Name of the Teacher: Annapali Meshram

Date: 05/11/2022

Title of Activity: Demonstration of diffraction using blade and laser

Sr. No.	Name of Student	Batch	Mobile No.	Email ID	Signature
---------	-----------------	-------	------------	----------	-----------

1	Kajal P. Nighot	S-8	9373250623	Kajalnighot2000@gmail.com	
2	Kajal Prakashwar Prasad	S-8	7410703188	prasadkajal000@gmail.com	
3	Mansi Ashok Badole	S-8	7796308467	mansibadole@gmail.com	
4	Atharva Vinod Ingle	S-7	9022468606	atharviningle23@gmail.com	
5	Ayush R. Basilkar	S-5	9519445072	ayushbasilkar@gmail.com	
6	Atharav P. Umate	S-5	9284641511	atharavumate@gmail.com	
7	Jasraj D. Kalival	S-8	9370820525	jasrajkalival47@gmail.com	
8	Mansi S. Fatimg	S-8	8767154685	mansifatimg2110@gmail.com	
9	Ritul K. Bisen	S-5	7028810840	ritulbisen06@gmail.com	
10	Shweta R. Bedwal	S-5	8080440184	shwetabedwal2605@gmail.com	
11	Sakshi M. Ingle	S-9	9067877694	inglesakshi702@gmail.com	
12	Simran Talmale	S-9	7972530938	simrantalmale@gmail.com	
13	Anuj Mishra	S-5	8103656208	anujmishra251202@gmail.com	
14	Ananya L. Motghare	S-7	7219218955	ananya.motghare@gmail.com	
15	Apuva S. Venkatar	S-7	9623613911	apuva.venkatar@gmail.com	
16	Priyanka S. Shah	S-3	7385197355	PS3347311@gmail.com	
17	Aasmin K. Sheikh	S-3	8668323588	aasmin1502@gmail.com	
18	Nutan Surjux	S-5	885570279	nutansurjux2@gmail.com	
19	Bhagyashree Thakre	S-5	8766925275	thakrebhagyashree2005.com	
20	Shraddha Rajc	S-10	7776804063	shraddharaje4@gmail.com	
21	Aditi Lute	S-5	7820812303	aditilute161@gmail.com	
22	Komal Patle	S-8	9128174850	komalpatle234@gmail.com	
23	Krunal Digrao		8010274903	krunaldigrao@gmail.com	
24	Nupur M. Sharma		9322042259	nupursharmas258@gmail.com	

Head of Department

24) Kamal Digrao	S-S	10276303		
25) Prachin R. Kotpalliwar	S-9	7498102097	prachin.kotpalliwar@gmail.com	Prachin
26) Adityakumar Shukla	S-S	9518994638	adityashukla2001@gmail.com	Aditya
27) Nitin Kulkarni	S-S	9893429005	nitinkulkarni706@gmail.com	Nitin
28) Nupur Sharma	S-8	9322042259	nupursharma2008@gmail.com	Nupur
29) Divya Karate	S-8	8605472901	divyakarate0406@gmail.com	Divya
30) Chetan Bopche	S-3	9172494628	chetanbopche27@gmail.com	Chetan
31) Prakhya Buzalkar	S-3	8329760853	Prakhya.Buzalkar580@gmail.com	Prakhya
32) Saanchita Patil	S-5	7218079074	saanchitapatil2003@gmail.com	Saanchita
33) Damini Katre	S-5	8208255685	damnikatre3@gmail.com	Damini
34) Bhumnika V. Thakre	S-3	2218249917	Bhumnika.thakre55@gmail.com	Bhumnika
35) Vrushali Shahare	S-1	9307516332	Vrushalishahare25@gmail.com	Vrushali
36) Swanandi Dharna	S-10	7420880982	swanandidharna31@gmail.com	Swanandi
37) Ruchika Patle	S-9	8669335907	ruchikapatle4@gmail.com	Ruchika
38) Pawan Vishwakarma	S-3	7038608869	Pawanvishwakarma488@gmail.com	Pawan
39) Roshali D. Bhoskar	S-3	9579485592	bhoskarrashali@gmail.com	Roshali
40) Dharmaprajapati	S-7	9975037356	Dharmaprajapati7@gmail.com	Dharmaprajapati
41) Ashmit Juwan	S-7	9080238161	Ashmitjuwan@gmail.com	Ashmit
42) Akshay P. Khondare	S-5	7350356909	akshaykhondare79@gmail.com	Akshay
43) Hitesh G. Kaware	S-5	7058427112	hiteshkaware73@gmail.com	Hitesh
44) Nikitika G. Mishra	S-5	9067445711	Kamavanshadkaminikam100@gmail.com	Nikitika
45) Omkumar D. Devanjan	S-5	963624388	omkumardi12@gmail.com	Omkumar
46) Aditya Kumar Singh	S-5	7350543501	adityasingh28818@gmail.com	Aditya
47) Dipesh Parle	S-7	9623389676	parledipesh51@gmail.com	Dipesh
48) Vaishu S. Nimje	S-9	9579997869	vaishunimje2003@gmail.com	Vaishu
49) Vatan S. Sonwame	S-9	9975410765	vatansonwame@gmail.com	Vatan

(Signature)

HEAD
DEPARTMENT OF PHYSICS
Dharampath M. P. Deo Memorial
Science College, Nagpur



DHARAMPETH M. P. DEO MEMORIAL SCIENCE COLLEGE, NAGPUR

INTERNAL QUALITY ASSURANCE CELL (IQAC)

Activity Report

Date: 05/11/2022

Name of Organizing Department or Committee: Department of Physics

Name of the activity: NEP based Demonstration Activity for B.Sc. Sem-I

Suggested CRITERION point if any: Restricted to RTMNU BSc physics syllabus.

Date of Activity: 05/11/2022

Place of Activity: Room No. 004

Name of Guest Speaker/s or Judge/s or Chief Guest/s if any: NA

Title of the Activity: Elastic collision of same sized pebbles

Activity with newspaper coverage if any: No

Number of Participants: BSc Sem-I Students – 10

Name of the Teacher In-charge / Convener: Mr. Nikhil Somkule

Names of other Committee Members / Staff: N.A.

OUTCOME of the Activity with respect to academics:

This demonstration was done to show the students the principle of conservation of linear momentum. It states that, "When no external force act on the bodies, then linear momentum is conserved. i.e., Momentum before collision = Momentum after collision". In this demo two pebbles of same mass, size and shape were used, one was kept stationary on the ground and the other was used to strike the first pebble head on. After the collision it was observed that, the first pebble stopped and the second pebble gained the initial velocity of the first pebble, thus confirming the principle of conservation of linear momentum.

$$M_1U_1 + M_2U_2 = M_1V_1 + M_2V_2$$

DVV: Enclosed.

Activity data save in PC of: Lt. Dr. P. W. Ambekar

Prof. Pitambar Humane
IQAC Coordinator

CO ORDINATOR
INTERNAL QUALITY ASSURANCE CELL
DHARAMPETH, M. P. DEO MEMORIAL &
SCIENCE COLLEGE, NAGPUR

Name & Signature of Teacher In-charge

Dr. Akhilesh Peshwe
Principal

Principal
Dharampeth M.P. Deo Memorial
Science College, Nagpur.



Activity Report

Date: 7th November 2022

Name of Organizing Department or Committee: Electronics Department

Name of the activity: Guest Lecture

Suggested CRITERION point if any: Suggested criteria II

Date of Activity: 7th November 2022

Place of Activity: Electronics Lab,

Name of Guest Speaker/s or Judge/s or Chief Guest/s if any: Mr. Vipul V. Mishra,
Assistant Professor, Department of Electronics and Computer Science, RTMNU, Nagpur.

Title of the Activity: Guest Lecture

Number of Participants: 37

Name of the Teacher In-charge / Convener: Mrs. Leena P. Thakare

OUTCOME of the Activity with respect to mission vision of the institute and or academics:

Report

Guest Lecture for Sem III and Sem V was conducted by Department of Electronics, Dharampeth M. P. Deo Memorial Science College, Nagpur on 7th November 2022 from 11.30 am to 1.30 pm. The objective of taking this lecture was to aware the students about the cutting edge technology in wireless communication. The Guest Speaker was Mr. Vipul V. Mishra, Assistant Professor, Department of Electronics and Computer Science, RTMNU, Nagpur. He Spoke on topic "Cellular Mobile Communication". The speaker explained the basics of communication, types of communications, digital communication, concept of frequency reuse, multiplexing etc with examples. After the lecture, the students were given time to interact with the speaker. Students felt that the lecture was more informative and interactive. The Guest was introduced by Prof. Varsha Rangari. Formal vote of thanks was given by Mrs. Leena P. Thakare.



IQAC Co-ordinator
Dharampeth M. P. Deo Memorial
Science College, Nagpur-440033

Prof. Pitambar Humane
IQAC Coordinator

Prof. Varsha V. Rangari
Head of the Department

PRINCIPAL
Dharampeth M. P. Deo Memorial
Science College, Nagpur-440033
Principal



Dharampeth M. P. Deo Memorial Science College,
Nagpur
Department of Electronics

Invitation Letter

Date: 27th October 2022

To,
Mr. Vipul Mishra,
Assistant Professor,
Department of Electronics and Computer Science,
RTMNU, Nagpur.

Subject: Invitation letter to be Resource Person for Guest Lecture.

Dear Vipul,

Its give me immense pleasure to invite you to be the Resource Person for Guest Lecture in our department on "**Cellular Mobile Communication**" for Our second- and third-year electronics students to be held on 7th November 2022. It will be very kind of you if you accept our invitation for the same.

Thank You,

Accepted
[Signature]

[Signature]
Dr. Varsha V. Rangon
Professor & Head
Department of Electronics
Dharampeth M.P. Deo Memorial
Science College, Nagpur



Dharampeth M. P. Deo Memorial Science College, Nagpur
Department of Electronics

Appreciation Letter

Date: 7th November 2022

To,
Mr. Vipul Mishra,
Assistant Professor,
Department of Electronics and Computer Science,
RTMNU, Nagpur.

Dear Vipul,

On behalf of Department of Electronics, Dharampeth M. P. Deo Memorial Science College, Nagpur, I would like to appreciate you for accepting our invitation to be Resource person for guest lecture.

I appreciate your efforts to prepare and deliver presentation on "Cellular Mobile Communication" for our second- and third-year electronics students to be held on 7th November 2022.

Once again, thank you and we appreciate your continued support.

Sincerely,

Dr. Varsha V. Rangari
Professional & Head
Department of Electronics
Dharampeth M.P. Deo Memorial
Science College, Nagpur



DHARAMPETH M. P. DEO MEMORIAL SCIENCE COLLEGE,
North Ambazari Road, Near Ambazari Lake, Nagpur-440033

DATA VALIDATION & VERIFICATION (DVV)

Name of the Programme : Guest Lecture
Date of the Programme : 7/11/2022
Name of Chief Guest if any : Shri. Vipul Mishra
Name of Guest Speaker if any : Shri. Vipul Mishra

Sr. No.	Name of the Participant	Mobile Number	E-mail Id	Signature
1)	Prakash M. Khanna	9011599643	prakash2002khan@gmail.com	Prakash
2)	Prathmesh S. Bedhiye	9765262138	Prathmeshbedhiye@gmail.com	Prathmesh
3)	Sagar O. Sonwane	9356591564	SagarSonwane706@gmail.com	Sagar
4)	Susmitha P. Sharma	9130964601	Susmithasharma1069@gmail.com	Sharma
5)	Kurran R. Waghade	9325845366	KurranWaghade09@gmail.com	Kurran
6)	Ankita L. Sonwane	9579661554	ankitasonwane10@gmail.com	Ankita
7)	Pratiksha S. Umare	9859175006	pratikshaumare50@gmail.com	Pratiksha
8)	Megha T. Bisen	7517953260	bisen7652@gmail.com	Bisen
9)	ABHIJEET S. MANKAR	8738099642	abhijeetmankar5@gmail.com	Abhi
10)	Tommy S. Godam	7262034356	tommygodam1@gmail.com	T-S Godam

Signature of:

Programme In-charge

CO ORDINATOR
INTERNAL QUALITY ASSURANCE CELL
DHARAMPETH, M. P. DEO MEMORIAL &
SCIENCE COLLEGE, NAGPUR

Principal
Dharampeth M.P. Deo Memorial
Science College, Nagpur.



DHARAMPETH M. P. DEO MEMORIAL SCIENCE COLLEGE,
North Ambazari Road, Near Ambazari Lake, Nagpur-440031

DATA VALIDATION & VERIFICATION (DVV)

11)	Pratiksha R. Bhandarkar	8329760853	Pratiksha.Bhandarkar56@gmail.com	Bhandarkar
12)	Prasanna M. Bhade	9934016826	PrasannaBhade	Bhade
13)	Tejas S. Wadhawe	7038980231	Anjaliwadhawe@gmail.com	Tejas
14)	Asmin K. Sheikh	8668323568	asmin0209@gmail.com	AsminK.
15)	Preksha V. Londe	7719991409	prekshavlonde2200	Preksha
16)	Urvashi S. Umathe	9177779259	urvashiumathe@gmail.com	Urvashi
17)	Mansi D. Nandanwar	7769322027	mansinandanwar14@gmail.com	Mansi
18)	Sadhana M. Pandey	7276017322	sadhanapandey18@gmail.com	Sadhana
19)	Sakshi V. Kanade	8806934839	sakshikanade32@gmail.com	Sakshi
20)	Urnati C. Chopde	9022627619	urnatichopde2002@gmail.com	Urnati
21)	Chetan V. Bopche	9172484628	chetanbopche21@gmail.com	Chetan
22)	Anush S. Gowade	8080004076	anushs6008@gmail.com	Anush
23)	Yash R. Wadkar	7220929422	yashwadkar5011	Yash
24)	Pawan Vishwakarma	7058408869	pawarvishwakarma67608.com	Pawan
25)	Sandeep Sunde	9067118497	sandeepsunde15@gmail.com	Sandeep
26)	Rahul Kowade	9359525716	kowade Rahul @ 062@gmail.com	Rahul

Signature of:

Programme In-charge

COORDINATOR
INTERNAL QUALITY ASSURANCE CELL
DHARAMPETH, M. P. DEO MEMORIAL &
SCIENCE COLLEGE, NAGPUR

Principal
Dharampeth M.P. Deo Memorial
Science College, Nagpur.



DHARAMPETH M. P. DEO MEMORIAL SCIENCE COLLEGE,
North Ambazari Road, Near Ambazari Lake, Nagpur- 440033

DATA VALIDATION & VERIFICATION (DVV)

27	Nirish Navghare	9659373735	navgharenish@gmail.com Jug.Patil0326@gmail.in	Navghare Jug P.
28	Jay Anilbhui Patil	7385436956		
29	Rajwade shilpanath shah	7340851865	25.334711@gmail.com Pravin.Sitaram@gmail.com	Rajwade Pravin
30	Pratish A. Sithe	9022553251		
31	Jayvi A. Katarakar	7888116270	jayvikatarakar@gmail.com	Jayvi
32	Rajal L. Rohad	9175635273	RajalRohad@gmail.com	Raja
33	Mulrand S. Hood	9609785822	mulrandhood2003@gmail.com	Mulrand
34	Mahesh. P. Mastur	902195173	maheshmastur@gmail.com	Mahesh
35	Pratham M. Sansar	8275451474	pratham.sansar.412	Pratham
36	Aashi. B. Singh	9709208740	Aashibsingh2000	Aashi
37	Sakshi. S. Huddale	9405142450	huddalesakshi@gmail.com	Sakshi

Signature of:

Pratish A. Sithe
Programme In-charge

[Signature]

CO ORDINATOR
INTERMEDIATE COORDINATION CELL
DHARAMPETH, M. P. DEO MEMORIAL &
SCIENCE COLLEGE, NAGPUR

[Signature]

Principal
Dharampeth M.P. Deo Memorial
Science College, Nagpur.



DHARAMPETH M. P. DEO MEMORIAL SCIENCE COLLEGE,
North Ambazari Road, Near Ambazari Lake, Nagpur-440033

DATA VALIDATION & VERIFICATION (DVV)

Name of the Programme : Guest Lecture on "Instruments for Generation of waveforms"
 Date of the Programme : 12th November, 2022
 Name of Chief Guest if any : _____
 Name of Guest Speaker if any : Mr. Abhijeet Kshirsagar

Sr. No.	Name of the Participant	Mobile Number	E-mail Id	Signature
1.	Simran Khimale	7666330683	simrandhimala80@gmail.com	
2.	TANU . H. JINGH	8806855808	tanusingh69492@gmail.com	
3.	Tejas Dongre	9322578918	Tj9874@gmail.com	
4.	Ved.S. Choudhary	7498572706	vedchoudhary1276@gmail.com	
5.	Jay Anilbhau Patil	7385436956	jay.ah110326@gmail.com	
6.	Uday . c. Baghose	8483542609	baghoseuday@gmail.com	
7.	Rohit Kawade	9359525716	KawadeRohit19@gmail.com	
8.	Ankush . S. Gunde	8080004076	agundes@gmail.com	
9.)	vaithes A. Gangekar	7507907178	gangekarvaithes@gmail.com	
10)	Tom Waghmare	8855919474	ishanwaghmare9474@gmail.com	

Signature of:

Programme In-charge

IQAC Coordinator

INTERNAL QUALITY ASSURANCE CELL
DHARAMPETH, M. P. DEO MEMORIAL &
SCIENCE COLLEGE, NAGPUR

Principal

Dharampeth M.P. Deo Memorial
Science College, Nagpur.



DHARAMPETH M. P. DEO MEMORIAL SCIENCE COLLEGE,
North Ambazari Road, Near Ambazari Lake, Nagpur- 440033

DATA VALIDATION & VERIFICATION (DVV)

11)	Bhagyashali D. Chavare	7796434177	sakshinidare2017@gmail.com	B. D. Chavare
12)	Tushal R. Achare	9075995617	achartushal5@gmail.com	Tushal
13)	Abhishek R. Singh	8208348103	abhi0832005@gmail.com	Abhishek
14)	Vedant O. Umasthakar	9049932753	umasthakarvedant@gmail.com	Vedant
15)	Chetan V. Popche	9172484628	chetanpopche27@gmail.com	Chetan
16)	Mangsi D. Nandanwar	7709322027	mangsinandanwar1@gmail.com	M. Nandanwar
17)	Sakshi V. Kharde	8806934839	sakshikharde32@gmail.com	Sakshi
18)	Urvashi S. Umasthakar	8177373253	umasthakaruvashi@gmail.com	U. Umasthakar
19)	Priyanka S. Shah	4385197365	rs324711@gmail.com	Priyanka
20)	Alismin K. Sheikh	8665322558	alismin06@gmail.com	A. Sheikh
21)	Tushar S. Wadhwa	7038980231	anjaliwadhw@gmail.com	Tushar
22)	Jayvi A. Kharakra	7888116270	jayvikharakra@gmail.com	Jayvi
23)	Bhagyawathi Pandey	9175302601	pandeybhagyawathi@gmail.com	B. Pandey
24)	Sachin M. Patil	7276017322	sachinpatil91@gmail.com	Sachin
25)	Urvashi C. Chopde	9022627617	urvashichopde2002@gmail.com	U. Chopde
26)	Jyeshth R. Madhkar	7020883421	jyeshthmadhkar@gmail.com	Jyeshth

Signature of:

Programme In-charge

IQAC Coordinator
CO ORDINATOR
INTERNAL QUALITY ASSURANCE CELL
DHARAMPETH, M. P. DEO MEMORIAL &
SCIENCE COLLEGE, NAGPUR

Principal
Dharampeth M.P. Deo Memorial
Science College, Nagpur.



DHARAMPETH M. P. DEO MEMORIAL SCIENCE COLLEGE, NAGPUR
INTERNAL QUALITY ASSURANCE CELL (IQAC)

Activity Report

Date: 07-11-2022

Name of Organizing Department or Committee: Department of Statistics

Name of the activity: Graphical representation of inflation, deflation index of last 5 years.

Suggested CRITERION point if any:

Date of Activity: 7th November 2022

Place of Activity: Statistics lab

Name of Guest Speaker/s or Judge/s or Chief Guest/s if any:

Title of the Activity: Graphical representation of inflation, deflation index of last 5 years.

Number of Participants: 18

Name of the Teacher: Gauri Sinekar

Names of other Committee Members / Staff: N.A.

OUTCOME of the Activity with respect to mission vision of the institute and or academics:

Student get the knowledge about Graphical Representation. With the help of Graphical representation, student knows the concept of inflation and deflation. How to analyse data regarding inflation and deflation. Also students find out the inflation and deflation trend.

Activity with newspaper coverage if any: No

Activity data save in PC of: Department of Statistics

Prof. Pitambar Humane
IQAC Coordinator

Name & Signature of Teacher In-charge

Dr. Akhilesh Peshwe
Principal

Principal
Dharampeth M.P. Deo Memorial
Science College, Nagpur.

CO ORDINATOR
INTERNAL QUALITY ASSURANCE CELL
DHARAMPETH, M. P. DEO MEMORIAL &
SCIENCE COLLEGE, NAGPUR



DHARAMPETH M. P. DEO MEMORIAL SCIENCE COLLEGE NAGPUR

Department of Statistics

NEP ACTIVITY

Paper - II

Unit - II

Class: B.Sc. Sem. - III

Name of the Teacher: Gauri S. Sinekhar

Date: 07/11/22

Title of Activity: Graphical representation of inflation, deflation index of last 5 year.

Sr. No.	Name of Student	Batch	Mobile No.	Email ID	Signature
1.	Ketan G. Bhojra	Scom	9657987276	ketanbhojra53@gmail.com	
2.	Harshal N. Ajankar	Scom	9527732348	harshalajankar1234@gmail.com	
3.	Ishu S. Nemade	Scom	7028494761	ishunemade.72@gmail.com	
4.	Vicky A. Singh	Scom	9834482931	vicky.singh11032001@gmail.com	
5.	Suman R. Singh	Scom	9322018536	suman.r.singh12345678@gmail.com	
6.	Savil B. Singh	S. Com	7258868502	savilbsingh@gmail.com	
7.	Prajakta Pawar	Scom	9356905759	prajakta2404@gmail.com	
8.	Suamini Rajankar	S. Com	9822200508	Suamini.rajankar@gmail.com	
9.	Aman D. Chavhan	Scom	7819486153	amanchavhan71@gmail.com	
10.	Vrushali Shobare	Scom	9307516332	vrushali8shobare2504@gmail.com	
11.	Prerushkotta Parashkar	Scom	7020643071	prerushkar.purushkotta@gmail.com	
12.	Anjali V. Rangankar	S. Com	8830031253	anjali.rangankar42@gmail.com	
13.	Sarthak Jichkar	Scom	8605710878	Sarthak.jichkar@gmail.com	
14.	Avishkar A. Bansal	Scom	7820241188	avishkarbansal02@gmail.com	
15.	Sumit Saboo	Scom	9322411088	sumitsaboo250@gmail.com	
16.	Devang. Karia	Scom	7888248500	devang@gmail.com	
17.	Khushi Waghade	Scom	9146520783	Khushidwaghade1@gmail.com	
18.	VAISHALI JADHAV	Scom	9156910355	vaishali93@gmail.com	

G. Sinekhar
Signature of Teacher

G. Sinekhar
Teacher Incharge



DHARAMPETH M. P. DEO MEMORIAL SCIENCE COLLEGE, NAGPUR

INTERNAL QUALITY ASSURANCE CELL (IQAC)
Activity Report

Date: 07/11/2022

Name of Organizing Department or Committee: Department of Statistics

Name of the activity: Activity on stratified sampling (Diagrammatic Explanation)

Suggested CRITERION point if any: Restricted to RTMNU BSc Statistics syllabus.

Date of Activity: 07/11/2022

Place of Activity: Statistics Lab

Name of Guest Speaker/s or Judge/s or Chief Guest/s if any: NA

Title of the Activity: Diagrammatic (or form a chart) explanation of stratified sampling

Activity with newspaper coverage if any: No

Number of Participants: 20

Name of the Teacher: Ms. Kumudini Kadbe

Names of other Committee Members / Staff: N.A.

OUTCOME of the Activity with respect to academics:

In this activity students understood what stratified sampling is all about. How it can be explained diagrammatically. Different aspects of diagrammatic explanations.

DVV: Enclosed.

Activity data save in PC of: Lt. Dr. P. W. Ambekar

Prof. Pitambar Humane
IQAC Coordinator

CO ORDINATOR
INTERNAL QUALITY ASSURANCE CELL
DHARAMPETH, M. P. DEO MEMORIAL &
SCIENCE COLLEGE, NAGPUR

Name & Signature of Teacher In-charge

Dr. Akhilesh Peshwe
Principal

Principal
Dharampeth M.P. Deo Memorial
Science College, Nagpur.



DHARAMPETH M. P. DEO MEMORIAL SCIENCE COLLEGE NAGPUR

Department of Statistics

Class: B.Sc. Sem. - V

NEP ACTIVITY

Paper: II

Unit: III

Name of the Teacher: Kumudini Kadbe

Date: 07/11/22

Title of Activity: Diagrammatic (or form a chart) explanation of Stratified Sampling

Sr. No.	Name of Student	Batch	Mobile No.	Email ID	Signature
1	Prachi S. Manusmare	PSM (1)	9356969609	prachimenusmare@gmail.com	<u>Prachi S. Manusmare</u>
2	Himanshu R. Lakhe	PSM	7448252469	himanshulakhe20@gmail.com	<u>Lakhe</u>
3	Piyush G. Kapse	PSM	9373562022	Kapsepiyush03@olan	<u>Piyush</u>
4	Pratiksha S. Thakre	PSM	8459570299	Pratikshathakre1709@gmail.com	<u>Pratiksha</u>
5	Divyani U. Dhule	PSM	7030731921	divyanidhule2002@gmail.com	<u>Divy Dhule</u>
6	Uday P. Khandarkar	PSM	9525397196	udaykhandarkar89@gmail.com	<u>Khandarkar</u>
7	Sakshi L. Bhanupatke	PSM	8311219372	Sakshilbhanupatke@gmail.com	<u>Sakshi</u>
8	Vaibhav G. Rane	PSM	7744957382	vaibhavrane2207@gmail.com	<u>Rane</u>
9	Proful G. Garkwad	PSM	7620511383	Profulgarkwad1999@gmail.com	<u>Proful</u>
10	Vishal V. Gishale	SCOM	9673681472	Vishalgishale22@gmail.com	<u>Gishale</u>
11	Saurabh V. Raut	SCOM	9527229213	Saurabh.raut.1725@gmail.com	<u>Raut</u>
12	Rishikesh R. Dethre	SCOM	8788199260	Rishikeshdethre2002@gmail.com	<u>Dethre</u>
13	Neha J. Bankar	SCOM	8053477553	neha2002bankar@gmail.com	<u>Bankar</u>
14	Divya R. Patil	SCOM	7757052463	divya.patil.953@gmail.com	<u>Patil</u>
15	Tanvi S. Mahule	SCOM	7057844982	tanvimahule4@gmail.com	<u>Mahule</u>
16	Sahil R. Jitwade	SCOM	9376414643	sahiljitwade73@gmail.com	<u>Jitwade</u>
17	Komal M. Kumbhar	SCOM	7620314869	kumbharykomal94@gmail.com	<u>Komal</u>
18	Sumit R. Lakhe	SCOM	9021627757	sumitlakhe262@gmail.com	<u>Lakhe</u>
19	Pranjal D. Sawarkar	SCOM	7385758510	pranjalsawarkar1234@gmail.com	<u>Sawarkar</u>
20	Jarug P. Patke	SCOM	9422486064	Jarug.patke.2002@gmail.com	<u>Patke</u>

Kumudini Kadbe
Signature of Teacher

Kumudini Kadbe
Teacher Incharge



DHARAMPETH M. P. DEO MEMORIAL SCIENCE COLLEGE, NAGPUR
INTERNAL QUALITY ASSURANCE CELL (IQAC)

Activity Report

NEP Activity 2022-23

Date: 14/11/2022

Name of Organizing Department or Committee: Department of Chemistry

Name of the activity: NEP Activity

Suggested CRITERION point if any: Criterion II

Date of Activity: 07-11-2022

Place of Activity: Room No. 5

Name of Guest Speaker/s or Judge/s or Chief Guest/s if any: _____

Title of the Activity: Structural determination of Quinoline and Isoquinoline (Sem V, Paper I, Unit II)

Number of Participants: 24

Name of the Teacher In-charge / Convener: Dr Deepika Brijpuriya

Names of other Committee Members / Staff: Dr Vaishali Meshram

OUTCOME of the Activity with respect to mission vision of the institute and or academics:

This is student centric activity. Structural determination of Quinoline and Isoquinoline helps the student to understand, the bonding of molecular orbital, its electronic configuration in ground and excited state. With this activity, student clearly understand with the difference between cyclic and heterocyclic compound. Electrophilic substitution, Nucleophilic substitution, and aromaticity are the concept cleared by this activity.



Activity with newspaper coverage if any: _____

Activity data save in PC of: Department of Chemistry

Note: Kindly share geotag photographs separately along with report on igacdsc2022@gmail.com

Prof. Pitambar Humane
IQAC Coordinator

CO ORDINATOR
INTERNAL QUALITY ASSURANCE CELL
DHARAMPETH, M. P. DEO MEMORIAL &
SCIENCE COLLEGE, NAGPUR

Dr. Deepika Brijpuriya
Name & Signature of Teacher In-charge

Dr. Akhilesh Peshwe
Principal

PRINCIPAL
Dharampeth M.P. Deo Memorial
Science College, Nagpur-440033



DHARAMPETH M. P. DEO MEMORIAL SCIENCE COLLEGE,
North Ambazari Road, Near Ambazari Lake, Nagpur- 440033

DATA VALIDATION & VERIFICATION (DVV)

Name of the Programme : NEP ACTIVITY (Structural Determination of Quinaline and Isoquinoline)
Date of the Programme : 7/11/2022
Name of Chief Guest if any : —
Name of Guest Speaker if any : —

Sr. No.	Name of the Participant	Mobile Number	E-mail Id	Signature
1	Pragya R Jha.	9665852975	pragya1697@gmail.com	<u>Jha</u>
2.	Priyanshi .P. Singh	7219259020	priyanshisingh18040@gmail.com	<u>Singh</u>
3-	Chaitali .M. Bumbade	9359540394	Chaitali2020b@gmail.com	<u>Chaitali</u>
4.	Akanksha R. Yelufe	8767935524	akankshayelufe@gmail.com	<u>Akanksha</u>
5.	Anushka .S. Das	7058933157	ad04092001@gmail.com	<u>Das</u>
6.	Pallavi Y. Bhagat	9022654940	Pallavi2208@gmail.com	<u>Bhagat</u>
7.	Supriya Patle	7757671925	PatleSupriya012@gmail.com	<u>Patle</u>
8.	Vaishnavi R. Chandekar	7249882964	vaishnavi.chandekar@gmail.com	<u>Chandekar</u>
9.	Ishwan Suryawanshi	8087317297	SuryawanshiIshwan123@gmail.com	<u>Ishwan</u>
10.	Vishal Kumar Singh	9610187223	singhvishal96a@gmail.com	<u>Vishal</u>

Signature of:

Abhishek
Programme In-charge

Abhishek
CO-ORDINATOR
IQAC Coordinator
INTERNAL QUALITY ASSURANCE CELL
DHARAMPETH, M. P. DEO MEMORIAL &
SCIENCE COLLEGE, NAGPUR

Abhishek
Principal
PRINCIPAL

Dharampeth M.P. Deo Memorial
Science College, Nagpur-440033



DHARAMPETH M. P. DEO MEMORIAL SCIENCE COLLEGE,
North Ambazari Road, Near Ambazari Lake, Nagpur- 440033

DATA VALIDATION & VERIFICATION (DVV)

Name of the Programme : _____
Date of the Programme : 7/11/22
Name of Chief Guest if any : _____
Name of Guest Speaker if any : _____

Sr. No.	Name of the Participant	Mobile Number	E-mail Id	Signature
11.	Anshuman Sharma	9370892462	anshuman.sharma@slu.ac	<u>Anshuman</u>
12.	Chetan Ramesh Kamthe	9637271601	Kamthe.chetan.B@gmail.com	<u>Kamthe</u>
13.	Akash. Ashok. Sikdar	9175422051	Sikdar.akash@PS@gmail.com	<u>Akash</u>
14.	Suraj B. Shende	9356666487	Surajbshende2018@gmail	<u>Shende</u>
15.	Shivam S. Mawrya	9607873702	ShivamMawrya12911@gmail	<u>Mshivam</u>
16.	Priyanka L. Gujwar	9579263881	priyankagujwar2001@gmail.com	<u>Priyanka</u>
17.	Sushila S. Puwti	9507433390	SushilaPuwti2004@gmail.com	<u>Spuwti</u>
18.	Sonam M. Upade	9890230462	upradesonam@gmail.com	<u>Upade</u>
19.	Anjali R. Mishra	9319948106		<u>Anjali</u>
20.	AMISHA R. Ande	8767618394		<u>Ande</u>

Signature of:

Anika

Programme In-charge

Anika
IQAC Coordinator

COORDINATOR
INTERNAL QUALITY ASSURANCE CELL
DHARAMPETH, M. P. DEO MEMORIAL &
SCIENCE COLLEGE, NAGPUR

Anika
Principal

Principal
PRINCIPAL
Dharampeth M.P. Deo Memorial
Science College, Nagpur-440033



DHARAMPETH M. P. DEO MEMORIAL SCIENCE COLLEGE,
North Ambazari Road, Near Ambazari Lake, Nagpur- 440033

DATA VALIDATION & VERIFICATION (DVV)

Name of the Programme : _____
Date of the Programme : 7/11/22
Name of Chief Guest if any : _____
Name of Guest Speaker if any : _____

Sr. No.	Name of the Participant	Mobile Number	E-mail Id	Signature
21	Aspita .T. Dakhale	806866758	aspitadekhal02@gmail.com	<i>Aspita</i>
22	Jayashree D. Hiwase	7385473157	Jshihwase1@gmail.com	J. D. Hiwase
23.	TEJAL A Mankar	9822458697	tejal.mankar.933@gmail.com	TEJAL
24.	Laxmi .bi. sayam	7517793675	Sayamlaxmi989@gmail.com	Laxmi

Signature of:

Aspita
Programme In-charge

Chand
IQAC Coordinator

INTERNAL QUALITY ASSURANCE CELL
DHARAMPETH M. P. DEO MEMORIAL
SCIENCE COLLEGE, NAGPUR

Tejal
Principal
PRINCIPAL

Dharampeth M.P. Deo Memorial
Science College, Nagpur-440033



DHARAMPETH M. P. DEO MEMORIAL SCIENCE COLLEGE, NAGPUR
INTERNAL QUALITY ASSURANCE CELL (IQAC)
Activity Report

Date: 10/11/2022

Name of Organizing Department or Committee: Microbiology Department

Name of the activity: Felicitation and Guest lecture of the Alumnus

Suggested CRITERION point if any: Criterion II. and V

Date of Activity: 9th Nov 2022

Place of Activity: Late shree Vinayakrao Phatak Hall

Name of Guest Speaker/s or Judge/s or Chief Guest/s if any: Guest Speaker- DR. VIVEK CHOPRA Senior Principal Scientist, Genetech, USA.

Title of the Activity: Felicitation and Guest lecture of the Alumnus DR. VIVEK CHOPRA Senior Principal Scientist, Genetech, USA.

Number of Participants: 100

Name of the Teacher In-charge / Convener: Dr. Vidya Kathoke

Names of other Committee Members / Staff: Dr Vaishali Pimple, Dr. Pratiksha Pohekar, Ms Diksha Zade

OUTCOME of the Activity with respect to mission vision of the institute and or academics:

To enhance the attachment & interaction of alumnus with the College.

The interaction of alumnus with the students will help in motivation or create interest in science field as well as in research field in India or abroad.

It will help to solve the doubts or queries of the students if they wish to study abroad through their guidance.

Activity with newspaper coverage any:



Prof. Pitambar Humane
IQAC Coordinator

Dr. Vidya R. Kathoke
Name & Signature of Teacher In-charge

Dr. Akhilesh Peshwe
Principal



Dharampeth M.P. Deo Memorial science College, Nagpur
Academic Session: 2022-2023
DEPARTMENT OF MICROBIOLOGY

Date: 07/11/2022

NOTICE

All the students of microbiology this is to inform you that department of microbiology is organizing a program on Felicitation of our proud alumnus Dr Vivek Chopra, Principal Scientist, US, followed by his guest lecture on 9th Nov 2022 at 10 :15 am. Its compulsory for every student to attend this program.

Venue: Late Shree Vinayakrao Phatak Hall
Date : 9th November 2022
Time: 10.30 am

W. Kathake

Head

Department of Microbiology

Dr. W. R. Kathake
Head
Dept. of Microbiology
Dharampeth M.P. Deo Memorial
Science College, Nagpur



DHARAMPETH M. P. DEO MEMORIAL SCIENCE COLLEGE,
North Ambazari Road, Near Ambazari Lake, Nagpur- 440033

DATA VALIDATION & VERIFICATION (DVV)

Name of the Programme : Felicitaton of Alumnus Dr Vivek Chopra followed by Guest Lecture
Date of the Programme : 9th Nov 2022
Name of Chief Guest if any : Dr Vivek Chopra Senior Principal Scientist, Genetech USA
Name of Guest Speaker if any : Dr Vivek Chopra

Sr. No.	Name of the Participant	Mobile Number	E-mail Id	Signature
1)	Sagar S. Bawane	9975460979	Sagarbawane637@gmail.com	
2)	Chirayu B. Dolai	8010135012	chirayudolai22@gmail.com	
3)	Vaibhav A. Malewar	8767838219	vaibhavmalewar74@gmail.com	
4)	Pratiksha S. Navghare	8623033760	NavgharePratiksha94@gmail.com	
5)	Nikita S. Bhave	9860159628	nikitabhav98@gmail.com	
6)	Sureti Longadje	8390516517	suretilongadje11@gmail.com	
7)	Vishakha Basulante	8329639834	VishakhaBasulante@gmail.com	
8)	Kalyani Shahare	9307046378	ShahareKalyani5@gmail.com	
9)	Vaishnavi Kapse	8983751089	Vaishnavikapse05@gmail.com	
10)	Shital Bankar	7758055139	Shitalbankar122@gmail.com	

Signature of:

In-charge

IQAC Coordinator

Principal
Dharampeth M. P. Deo Memorial
Science College, Nagpur



DHARAMPETH M. P. DEO MEMORIAL SCIENCE COLLEGE,
North Ambazari Road, Near Ambazari Lake, Nagpur- 440033

DATA VALIDATION & VERIFICATION (DVV)

11)	Uamila V. Bondre	9370673867	bondre.uamila2000@gmail.com	Uamila
12)	Shreyas S. Dhanule	8888264004	Shreyas.dhanule121@gmail.com	Shreyas
13)	Vidhansi A. Shende	8080640782	Vidhansi.Shende37@gmail.com	V.A. Shende
14)	Kalpana D. Suhagpure	9579236712	Kalpana.suhagpure@gmail.com	Suhagpure
15)	Tina U. Rahangdale	9921776769	tina.rahangdale@gmail.com	Rahangdale
16)	Vaishnavi R. Lakhe	8669594864	chhatuli.lakhe531@gmail.com	Lakhe
17)	Chhatuli G. Wadikar	9325047907	chhatuli.wadikar@gmail.com	Wadikar
18)	Shyama D. Nasse	9765943998	shyama.nasse@gmail.com	Nasse
19)	Siddharth Hirkar	9579092931	hirkar.siddharth123@gmail.com	Hirkar
20)	Ketaki R. Kirpal	9112759066	Ketaki.kirpal12@gmail.com	Kirpal
21)	Afzina R. Sheikh	8080083981	afzinashikh973@gmail.com	Sheikh
22)	Ankush A. Raut	9767873447	ankush.raut2003@gmail.com	Raut
23)	Anushree Chandel	9145631751	anushree.chandel2001@gmail.com	Chandel
24)	Smriti Vaidya	8856908764	Smriti.Vaidya36@gmail.com	Smriti
25)	Prachal M. Meshram	7028735508	prachal.meshram47@gmail.com	Meshram
26)	Anchal S. Singh	7875537925	Santosh.singh2392@gmail.com	Anchal

Signature of:

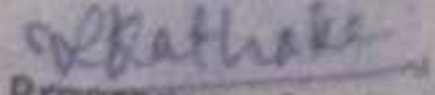
Programme In-charge

IQAC Coordinator

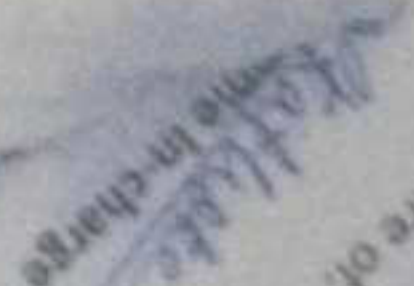
Signature of:



DHARAMPETH M. P. DEO MEMORIAL SCIENCE COLLEGE,
North Ambazari Road, Near Ambazari Lake, Nagpur- 440033

DATA VAUDATION & VERIFICATION (DYC)

68	Arushi Chaphekar	7835173847	arushich01@gmail.com
49	Adha Sakhamale	9405197847	adha_sakha@rediffmail.com
45	Neha L. Wanjari	9373832266	nehawanjari1992@gmail.com
40	Arijati R. Thakre	7066554821	thakrearijati31@gmail.com
47	Komalika Lawalari	9322033866	komalikalawalari@gmail.com
48	Shrushti Manu	9280249534	shrushtimanu1912@gmail.com
49	Apeksha Kotangale	7559455799	ApekshaKotangale05@gmail.com
50	Anay Borkar	9145401246	Anayborkar@gmail.com
51	Aparna Mohare	7020649877	aparnamohare23@gmail.com
52	Maya Dhoke	901681628	mayanamsale30@gmail.com
53	Ravindra Khadse	8007198273	khadse5ravindra392@gmail.com
54	Jeet Sparshi	7020215431	jeetsparshi11@gmail.com
55	Aishul Kirnapure	9284067165	aishulkirnapure@gmail.com
50	Nisha V. Pandey	8605231390	attichele8605231390@gmail.com
57	Yogita Derge	7058437240	nyogitaderge@gmail.com

Signature of:

N. K. Thakre
Programme In-charge

IQAC Coordinator

N. K. Thakre
Signature of:





DHARAMPETH M. P. DEO MEMORIAL SCIENCE COLLEGE,
North Ambazari Road, Near Ambazari Lake, Nagpur- 440033

DATA VALIDATION & VERIFICATION (DVV)

Name of the Programme

FALICITATION OF ALUMINUS AND GUEST LECTURE

Date of the Programme

09/11/2022

Name of Chief Guest if any

Dr. Vivek Chopra, Principle Scientist Genetech USA

Name of Guest Speaker if any

Dr. Vivek Chopra

Sr. No.	Name of the Participant	Mobile Number	E-mail Id	Signature
1.	Siddharth Hirkanse - II nd	9579092931	hirkanesiddharth1234@gmail.com	
2.	Vaishnavi Gadge - II nd	9022976449	gadgenvaishnavi00@gmail.com	
3.	Gargi Hadge - II nd	797207661	gargihadge@gmail.com	
4.	Harsh Kodape - II nd	9604677672	harshkodape008@gmail.com	
5.	Vedant Baxy - II nd	8530455796	vedantbaxy2003@gmail.com	
6.	Prarajwal Bhoyan - II nd	8010434634	prarajwalb738@gmail.com	
7.	Rupesh. C. Bhokare - II nd	8805887370	bhokarerupesh@gmail.com	
8.	Rohit. A. Parate - II nd	9373097285	Parate.rohit.8@gmail.com	
9.	Purnali chawhane - I st	9699654562	Purnalichawhane69@gmail.com	
10.	Meenal choudhary - I st	9529014604	meenalchoudhary2004@gmail.com	

Signature of:

Programme In-charge

IQAC Coordinator

Principal
Dharampeth M. P. Deo Memorial
Science College, Nagpur



DHARAMPETH M. P. DEO MEMORIAL SCIENCE COLLEGE,
North Ambazari Road, Near Ambazari Lake, Nagpur- 440033

DATA VALIDATION & VERIFICATION (DVV)

Name of the Programme : Felicitation of Alumni and Guest lecture
Date of the Programme : 09/11/2022
Name of Chief Guest if any : Dr Vivek Chopra, Principal Scientist Genetech USA
Name of Guest Speaker if any : Dr Vivek Chopra

Sr. No.	Name of the Participant	Mobile Number	E-mail Id	Signature
1.	Laxmi Goude	7758058514	laxmigoode2908@gmail.com	
2.	Nandini Hadge	9370301679	nandinihadge17@gmail.com	
3.	Gargi Hadge	7972076671	gargihadge@gmail.com	
4.	Vaishnavi Gadge	9022976449	gadgervaishnavi00@gmail.com	
5.	Ishika Thakre	8010907069	ishithakre@gmail.com	
6.	Anjali Pali	7498102109	paliyanjali44@gmail.com	
7.	Anushree Wale	8530778433	anushriwale200@quora.com	
8.	Pranali Chauhan	9699654562	pranalichauhan69@gmail.com	
9.	Pratiksha Meshram	8459070338	meshrampratiksha14@gmail.com	
10.	Shruti M. Pawar	9527988707	ShrutiPawar0001@gmail.com	

Signature of:

Programme In-charge

IQAC Coordinator

Principal

Dharampeth M. P. Deo Memorial
Science College, Nagpur



DHARAMPETH M. P. DEO MEMORIAL SCIENCE COLLEGE,
North Ambazari Road, Near Ambazari Lake, Nagpur- 440033

DATA VAUDATION & VERIFICATION (DVV)

11)	Tammaray Choudhary	8600102341	tehdhara@rediffmail.com	Tej
12)	Tejas Salunke	7030730670	tejasSalunke2003@gmail.com	Tejas
13)	Prajwal Bhuyar	8010434634	prajwalb728@gmail.com	Prajwal
14)	Souraj Yadav	8767435158	SourajYadav2003@gmail.com	Souraj
15)	Sanket Lode	7972085380	SanketLode23@gmail.com	Sanket
16)	vedant Baxy	8530453796	vedantBaxy2003@gmail.com	Baxy
17)	Harsh Kodape	9604677672	harshkodape05@gmail.com	Kodape
18)	Manali Shinde	7249637434	manalishinde062@gmail.com	MZ
19)	Ankita Bhoyar	8788031173	ankitabhoyar06@gmail.com	Ankita
20)	Neha Chandratre	9370570933	nehachandratre51@gmail.com	Neha
21)	Avanti Chaphekar	7875173847	avantion@gmail.com	Avanti
22)	Astha Lakhaswade	9405197842	asthalakhaswade@gmail.com	Lakhaswade
23)	Mahi Thaware	9960629566	thawaremahit@gmail.com	Mahi
24)	Vaidehi Thote	7558499191	vaidehitote77@gmail.com	Vaidehi
25)	Umang Wauthi	9322428500	umangwauthi@gmail.com	Wauthi
26)	Ritika Sondhiya	9175581655	ritikasondhiya@gmail.com	Ritika

Signature of:

Programme In-charge

IQAC Coordinator

Principal



DHARAMPETH M. P. DEO MEMORIAL SCIENCE COLLEGE,
North Ambazari Road, Near Ambazari Lake, Nagpur- 440033

DATA VALIDATION & VERIFICATION (DVV)

27]	Siddhi Jivari	8087143696	siddhijivari0721@gmail.com	
28]	Kartika Deshmukh	9699720960	Kartika20@gmail.com	
29]	Muskan Kulkarni	9156889239	Muskankulkarni34@gmail.com	
30]	Sakshi Meshram	9145355733	MeshramSakshi210@gmail.com	
31]	Jagati Warkar			
32]	Fahi Chaudhari			
33]	Maasi Mate	84		
30]	Samiksha Kundekar	9145253158	samikshakundekar@gmail.com	
31]	Samiksha Chaudhari	7517090406	chaudhariesamiksha26@gmail.com	
32]	Suman Ashutosh. Singh	7249465307	missumansingh3@gmail.com	
33]	Roshani madhav Bambal	9325853408	roshani2018bb@gmail.com	
34]	Krushnali Sanjay Kudu	8625854995	KrushnaliKudu67@gmail.com	
35]	Bhumika D. Chedge	8830391103	bhumikachedge@gmail.com	
36]	Manish S. Gade	9970329857	manishgade21@gmail.com	
37]	Vivek P. Wiharegaonkar	8956482581	Vivekwharegaonkar@gmail.com	
38]	Balraj M. Deker	9420396682	Balrajwadekar@gmail.com	

Signature of:

Programme In-charge

IQAC Coordinator

Principal

Signature
Programme In-charge



DHARAMPETH M. P. DEO MEMORIAL SCIENCE COLLEGE, NAGPUR
INTERNAL QUALITY ASSURANCE CELL (IQAC)

Activity Report

Date: 23/01/2023

Name of Organizing Department or Committee: Training Placement and Career Guidance
Cell 22-23

Name of the activity: Guest Lecture

Suggested CRITERION point if any: Criterion V

Date of Activity: 10th November 2022

Place of Activity: Vinayakrao Phatak Hall

Name of Guest Speaker/s or Judge/s or Chief Guest/s if any: Mr. Jayant Pathak, Director,
AILSG, Nagpur

Title of the Activity: Employment Opportunities in Public Health And Sanitation

Number of Participants: 82

Name of the Teacher In-charge / Convener: Dr. Mrs. Shraddha Deshpande

Names of other Committee Members / Staff: Dr. Nitin Gaikwad Dr. Snehal Narale

OUTCOME of the Activity with respect to mission vision of the institute and or academics:

Mr. Jayant Pathak, Regional Director at All India Institute of Local Self Government – AILSG was the spokesperson. He explained about Sanitary Inspector Courses, Course syllabus in details, different job opportunities for mathematics and biology students.

Activity with newspaper coverage if any: Nil

Activity data save in PC of: Department of English



Prof. Pitambar Humane
IQAC Coordinator

CO ORDINATOR
INTERNAL QUALITY ASSURANCE CELL
DHARAMPETH, M. P. DEO MEMORIAL &
SCIENCE COLLEGE, NAGPUR

Dr. Mrs. Shraddha Deshpande
Teacher Incharge

Dr. Akhilesh Peshwe
Principal
Dharampeth M.P. Deo Memorial
Science College, Nagpur-440 033

DHARAMPETH M.P.DEO MEMORIAL SCIENCE COLLEGE,
NAGPUR

Training Placement and Career Guidance Cell -22-23

NOTICE

Date: 08/10/2022

All the students are hereby informed that Training Placement and Career Guidance Cell 22-23 is conducting a Guest Lecture on Employment opportunities in Public Health and Nutrition on 10th November 2022 at 12 noon in Vinayakrao Phatak Hall.

Students should attend the program positively.



Dr. Mrs. Shraddha Deshpande

Convener



DHARAMPETH M. P. DEO MEMORIAL SCIENCE COLLEGE,
North Ambazari Road, Near Ambazari Lake, Nagpur- 440033

DATA VALIDATION & VERIFICATION (DVV)

Name of the Programme : Employment Opportunities in Public Health and Sanitation Sector
Date of the Programme : 10th November 2022 for Science Graduates
Name of Chief Guest if any : Nil
Name of Guest Speaker if any : Mr. Jayant Pathak, Director AILSG Nagpur

Sr. No.	Name of the Participant	Mobile Number	E-mail Id	Signature
1)	Ishwan U. Suryawanshi	8887317297	Suryawanshiishwan 123@gmail.com	
2)	Vishal Kumar Singh	9610187223	singhvishal9602@gmail.com	
3)	Supriya Patle	7757571925	PatleSupriya@123@gmail.com	
4)	Anushka D. Das	7058933157	ad09092003@gmail.com	
5)	Psagye R Jha	9665852875	psagyer1994@gmail.com	
6)	Akanksha R Yelwe	8767935524	akankshayelwe@gmail.com	
7)	Priyanshi Singh	7219259020	priyanshisingh1804@gmail.com	
8)	Pathari Y. Bhagat	9022654940	Pathariy2208@gmail.com	
9)	Raksha D. Dhote	7498511875	rakshadhote3@gmail.com	
10)	Tanmay Bhute	7697250831	tanmaybhute900@gmail.com	

Signature of:

Programme In-charge

CO-ORDINATOR
IQAC Coordinator
INTERNAL QUALITY ASSURANCE CELL
DHARAMPETH, M. P. DEO MEMORIAL &
SCIENCE COLLEGE, NAGPUR

Principal
Principal
Dharampeth M.P. Deo Memorial
Science College, Nagpur



DHARAMPETH M. P. DEO MEMORIAL SCIENCE COLLEGE,
North Ambazari Road, Near Ambazari Lake, Nagpur- 440033

DATA VALIDATION & VERIFICATION (DVV)

11]	Shivam S. Mawrya	9607973707	Shivammawrya12911@gmail.com	Shivam
12]	Himanshu Lakhv	7448252469	himanshulakhoor@gmail.com	Himanshu
13]	Vaibhav S. Rane	7744951383	vaibhavarane@gmail.com	Vaibhav
14]	Prasay S. Dore	9830629245	Prasay23@gmail.com	Prasay
15]	Uday P. Kankarkar	9595897196	udaykankarkar8@gmail.com	Uday
16]	Sakshi L. Barapatre	8317219372	sakshi2002hb@gmail.com	Sakshi
17]	Dikshita Saheene	9028830801	dikshitesaheene@gmail.com	Dikshita
18]	Khushi Gupta	9922997235	kg098970@gmail.com	Khushi
19]	Komal Kumbhare	7620314869	KumbhareKomal84@gmail.com	Komal
20]	Neha Bankar	8055477553	neha2002bankar@gmail.com	Neha
21]	Divyani U. Ekhale	7030731921	divyamdhule2002@gmail.com	Divyani
22]	Prachi S. Manumare	9856969609	Prachi2020m@gmail.com	Prachi
23]	Tanu S. Mohule	7057844382	tanumohule85@gmail.com	Tanu
24]	Kautilk A. Adlakha	8530597159	k.adlakha@gmail.com	Kautilk
25]	Aakash A. Sirdar	9175422051	Akshayakush15@gmail.com	Aakash

Signature of:

Programme In-charge

CO ORDINATOR
INTERNAL QUALITY ASSURANCE CELL
DHARAMPETH, M. P. DEO MEMORIAL &
SCIENCE COLLEGE, NAGPUR

Principal
Dharampeth M.P. Deo Memorial
Science College, Nagpur.



DHARAMPETH M. P. DEO MEMORIAL SCIENCE COLLEGE,
North Ambazari Road, Near Ambazari Lake, Nagpur- 440033

DATA VALIDATION & VERIFICATION (DVV)

26)	Anshuman Sharma	9370892462	Anshumanisharma@gmail.com	Anshuman
27)	Chetan Ramesh Kamthe	9637271601	chetanrakesh66@gmail.com	Chetan
28)	Saurabh Shukla	7721802706	Saurabh77@gmail.com	Saurabh
29)	Suraj B. Shende	9356666487	Surajbshende2018@gmail.com	Shende
30)	Mukesh, S. Oraon	7249339368	Oraonm64@gmail.com	Mukesh
31)	Suraj Shyam Jode	8767635158	Surajshyamjode2@gmail.com	Suraj
32)	Sanket Jode	7972085380	Sanketjodek2@gmail.com	Sanket
33)	Pragijwal Mungle	9834234902	pragijwalmungle123@gmail.com	Pragijwal
34)	Hansh H. Waghmare	9112959406	Hanshwaghmare778@gmail.com	Hansh
35)	Adesh K. Hatwari	7517431162	adeshhatwari2003@gmail.com	Adesh Hatwari
36)	Manish S. Grade	9370329850	Manishgrade99@gmail.com	Grade
37)	Abdul Rahe Aman Shafique	7666938578	raheaman2811@gmail.com	Abdul
38)	Rinam e. Wankhede	8010966529	wankhederinam@gmail.com	Rinam
39)	Tisha D. Kature	9021541048	Tishakature@gmail.com	Tisha
40)	Shruti M. Pawar	9527988707	shrutipawar0001@gmail.com	Shruti

Signature of:

Programme In-charge

CO-ORDINATOR
INTERNATIONAL QUALITY ASSURANCE CELL
DHARAMPETH, M. P. DEO MEMORIAL &
SCIENCE COLLEGE, NAGPUR

Principal

Dharampeth M.P. Deo Memorial
Science College, Nagpur.



DHARAMPETH M. P. DEO MEMORIAL SCIENCE COLLEGE,
North Ambazari Road, Near Ambazari Lake, Nagpur- 440033

DATA VALIDATION & VERIFICATION (DVV)

41)	Rani. D. Kokate	7498945148	Ranikokate1009@gmail.com	Ranikokate
42)	Nandini Hodge	9370301679	nandinihodge17@gmail.com	Nandini Hodge
43)	Anushri. Wate	8530778433	anushriwate2001@gmail.com	Anushri Wate
44)	Laxmi Goude	7758058514	laxmigoode2908@gmail.com	Laxmi Goude
45)	Ishita Thakre	8010907069	ishithakre@gmail.com	Ishita Thakre
50)	Samiksha Kundekar	9145253158	samishkukuratkar@gmail.com	Samiksha Kundekar
51)	Ayushi Shukla	9373668043	ayushishukla28112002@gmail.com	Ayushi Shukla
52)	Madhura Bhendure	8767484914	MadhuraBhendure@gmail.com	Madhura Bhendure
53)	Samiksha R. Chaudhari	7517090406	choudhariesamikat1626@gmail.com	Samiksha R. Chaudhari
54)	Vivek R. Chakravarti	8956482581	vivekchakravarti@gmail.com	Vivek R. Chakravarti
55)	Bhumika D. Chedde	8530391103	Bhumikachedde@gmail.com	Bhumika D. Chedde
56)	Krushnali S. Kadu	8625854395	krushnalikodur@gmail.com	Krushnali S. Kadu
57)	Saloni Walele	7420396582	saloniwalele@gmail.com	Saloni Walele
58)	Tejas G. Salunke	7030710670	tejasalunke@gmail.com	Tejas G. Salunke
59)	Tanmay Choudhary	8600102341	tkhachary56@gmail.com	Tanmay Choudhary

Signature of:

Programme In-charge

COORDINATOR
INTERNAL QUALITY ASSURANCE CELL
DHARAMPETH, M. P. DEO MEMORIAL &
SCIENCE COLLEGE, NAGPUR

Principal

Dharampeth M.P. Deo Memorial
Science College, Nagpur.



DHARAMPETH M. P. DEO MEMORIAL SCIENCE COLLEGE,
North Ambazari Road, Near Ambazari Lake, Nagpur- 440033

DATA VALIDATION & VERIFICATION (DVV)

Name of the Programme : Employment Opportunity in Public Health and Sanitation Sector for Science graduates
Date of the Programme : 10th November 2022
Name of Chief Guest if any : Nil
Name of Guest Speaker if any : Mr. Jayant Patil, Director AILSG, Nagpur

Sr. No.	Name of the Participant	Mobile Number	E-mail Id	Signature
1	Diya Ramesh Patil	7757052663	diyapatil553@gmail.com	Rpatil
2	Pranjal D. Sawadkar	7385458510	pranjalsawadkar1234@gmail.com	Pawadkar
3	Ruchita S. Bhayari	9627832686	ruchitabhayari07@gmail.com	Bhayari
4	Khushi D. D. D. D.	9890009937	k4857471@gmail.com	Khushi
5	Bhumi D. Chedge	8830891103	bhunikuchedge@gmail.com	Chedge
6	Krushnali S. Kadi	8625854995	krushnalikadi67@gmail.com	Kadi
7	Vivek R. Wathwawagh	8356482591	vivekwathwawagh@gmail.com	Wathwawagh
8	Balraj M. Wadgaonkar	9420396682	balrajwadgaonkar@gmail.com	Wadgaonkar
9	Tejas G. Salunke	7030730670	tejasalunke2008@gmail.com	Salunke
10	Tanmay Choudhari	8600102341	tchoudhari8600@gmail.com	Choudhari

Signature of:

Programme In-charge

IQAC COORDINATOR
INTERNAL QUALITY ASSURANCE CELL
DHARAMPETH, M. P. DEO MEMORIAL &
SCIENCE COLLEGE, NAGPUR

Principal
Principal
Dharampeth M.P. Deo Memorial
Science College, Nagpur.



DHARAMPETH M. P. DEO MEMORIAL SCIENCE COLLEGE,
North Ambazari Road, Near Ambazari Lake, Nagpur- 440033

DATA VALIDATION & VERIFICATION (DVV)

11.	Anushri Wale	8530778433	anushriwale200@gmail.com	
12.	Nandini Hadge	9370301679	nandinihadge7@gmail.com	
13.	Daxmi Gorte	775805854	daxmigorde29@gmail.com	
14.	Ishika Thakre	8010207069	ishithakre22@gmail.com	
15.	Samiksha Kuntekar	9145253758	samikshakuntekar@gmail.com	
16.	Ayushi Shukla	9373668043	ayushishukla2112002@gmail.com	
17.	Madhura Phondke	8767484914	madhurasabirondur@gmail.com	
18.	Samiksha R. Choudhari	7517090406	choudhari.samiksha26@gmail.com	
19.	Samiksha R. Khasare	9604473539	sekha.khasare@gmail.com	
20.	Sani A. Rai	9855999509	sanirani17@gmail.com	
21.	Seema M. Lakda	7058728070	seema.lakda073@gmail.com	
22.	Pratikha Choudhari	7507317699	choudharypratikha200009	
23.	Sujata Phansaj. Souwane	9021135140	sujatasouwane2001@gmail.com	

Signature of:

Programme In-charge

CO-ORDINATOR
INTERNAL QUALITY ASSURANCE CELL
DHARAMPETH, M. P. DEO MEMORIAL &
SCIENCE COLLEGE, NAGPUR

Principal
Dharampeth M.P. Deo Memorial
Science College, Nagpur



DHARAMPETH M. P. DEO MEMORIAL SCIENCE COLLEGE,
North Ambazari Road, Near Ambazari Lake, Nagpur- 440033

DATA VALIDATION & VERIFICATION (DVV)

Name of the Programme : Inauguration of Women Cell (Best out of Waste)
Date of the Programme : 20th January 2023
Name of Chief Guest if any : Mrs. Bhakti Dixit
Name of Guest Speaker if any : -

Sr. No.	Name of the Participant	Mobile Number	E-mail Id	Signature
1	SAKSHI .R. CHARUNDE	7843018801	sakshicharunde@gmail	
2	Neha R. Vishwakarma	8983534173	nehavishwakarma650830@gmail.com	
3	Anshikha V. Jaiswarkar	9021391207	anshikhajaiswarkar@gmail.com	
4	Prema D. Chaudhari	7620384149	chaudhariprema294@gmail.com	
5	Shubhangi .R. Nishad	9518534076	shubhnishad351@gmail.com	
6	Hemlata D. Verma	7517058379	vamhentalata957@gmail.com	
7	Shalu T. Pardhi	8329115380	shalupardhi3@gmail.com	
8	Minal T. Patle	7350730164	minalpatle83@gmail.com	
9	Aditi Vaidya	9075714591	Aditivaidya619@gmail.com	
10	Khushi .R. Pali	8767607224	PaliKhushi@gmail.com	

Signature of:

Programme In-charge

COORDINATOR
INTERNAL QUALITY ASSURANCE CELL
DHARAMPETH, M. P. DEO MEMORIAL &
SCIENCE COLLEGE, NAGPUR

PRINCIPAL
Dharampeth M.P. Deo Memorial
Science College, Nagpur-440 033



DHARAMPETH M. P. DEO MEMORIAL SCIENCE COLLEGE,
North Ambazari Road, Near Ambazari Lake, Nagpur- 440033

DATA VALIDATION & VERIFICATION (DVV)

10.	Vaishnavi . K. Pradhan	9763169560	pradhanvaishnavi155@gmail.com	Pradhan.
11.	Shrushti Patekar	7387067403	Shrushtipatekar@gmail.com	Shrushti
12.	Pellavi Katre	8459277408	Pratra573@gmail.com	Pellavi
13.	Bhagyashree Ambule.	3359139068	ambuleb66@gmail.com	Ambule
14	Kimoya Kale	8866073792	kimoyakale@gmail.com	Kimoya
15.	Tanuja S. Konde	7841984450	kondetanuja33@gmail.com	Tanuja
16.	Avani S. Shenwai	9096507459	avanishenwai5@gmail.com	Avani
17.	Ajasi Wankhede	8767699751	wankhedeajasi@gmail.com	Ajasi
18.	Pragya S. Tiwari	6394098386	Pragyatiwari14052002@gmail.com	Pragya
19.	Priya K. Khawshi	9763617224	priyakhawshi5@gmail.com	Priya
20.	Prachi N. Lanekar.	8806244419	prachilanekar15@gmail.com	Prachi
20.	Khushbu Pali	8459565214	paliKhushbu59@gmail.com	Khushbu
21.	Harshata Wankhede	8263977208	harshatawankhede@gmail.com	Harshata
22	Tannu Vasthi	9322044903	tannuvasthi@gmail.com	Tannu
23)	Dhannapreeti R Lale	9975037856	dhananapreeti@gmail.com	Dhannapreeti
24)	Renuka Lande	7719951401	renukalande22@gmail.com	Renuka

Signature of:

Programme In-charge

CO-ORDINATOR
INTERNAL QUALITY ASSURANCE CELL
DHARAMPETH, M. P. DEO MEMORIAL &
SCIENCE COLLEGE, NAGPUR

PRINCIPAL
Dharampeth M.P. Deo Memorial
Science College, Nagpur-440 033



DHARAMPETH M. P. DEO MEMORIAL SCIENCE COLLEGE, NAGPUR
INTERNAL QUALITY ASSURANCE CELL (IQAC)

Activity Report

Date: 22nd, DEC 2022

Name of Organizing Department or Committee: BOTANY DEPARTMENT

Name of the activity: Word Puzzle

Suggested CRITERION point if any: CRITERION-1

Date of Activity: 10th Nov., 2022

Place of Activity: DHARAMPETH M.P. DEO MEMORIAL SCIENCE COLLEGE

Name of Guest Speaker/s or Judge/s or Chief Guest/s if any: NA

Title of the Activity: To prepare word puzzle on ecological factors

Number of Participants:36

Name of the Teacher In-charge / Convener: Dr. Mrs. Reshma Hiwase

Names of other Committee Members / Staff: Dr. Chandrakumar Patle, Mr. Amol Pimpalshende, Dr. Mrs. Sweta Rai & Mrs. Dipali Nikure

OUTCOME of the Activity with respect to mission vision of the institute and or academics: Word puzzles on ecological factors help to students to improve to correct answer and improve to task that require quick thinking and knowledge of ecological factors. It also helps to improve working memory on learning and achievements.

Activity with newspaper coverage if any: NA

Activity data save in PC of: Prof. Pitambar Humane's Laptop

Dr. Reshma Hiwase

Name & Signature of Teacher In-charge



Prof. Pitambar Humane
IQAC Coordinator

CO ORDINATOR
INTERNAL QUALITY ASSURANCE CELL
DHARAMPETH, M. P. DEO MEMORIAL &
SCIENCE COLLEGE, NAGPUR



Dr. Akhilesh Peshwe
Principal
Principal
Dharampeth M.P. Deo Memorial
Science College, Nagpur.



DHARAMPETH M. P. DEO MEMORIAL SCIENCE COLLEGE,
North Ambazari Road, Near Ambazari Lake, Nagpur- 440033

DATA VALIDATION & VERIFICATION (DVV)

Name of the Programme : To prepare word puzzles on Ecological Factors
Date of the Programme : 10th November 2022
Name of Chief Guest if any : _____
Name of Guest Speaker if any : _____

Sr. No.	Name of the Participant	Mobile Number	E-mail Id	Signature
1.	Asha sharnarao landge	9322231581	ashalandgeacol@gmail.com	Ashalandge
2.	Neha Ravindra khawase	8766738340	nehadonarkle@gmail.com	Neha Khawase
3.	Krushnaji S. Kady	8625854995	Krushnalikadugi@gmail.com	Kady
4.	Vivek R. Wadhvani	8956482331	Vivek.wadhvani@gmail.com	Vivek
5.	Bhumika O. Chedge	8830391105	bhumikachedge@gmail.com	Bhumika
6.	Madhura U. Bhandure	8767484914	Madhurabhandure@gmail.com	Madhura
7.	Babruj M. Wadla	9420396682	babrujwadla@gmail.com	Babruj
8.	Samiksha No. Kundekar	9145253158	samikshakundekar@gmail.com	Samiksha
9.	Samiksha P. Chaudhari	7517090406	chaudhari.samiksha@gmail.com	Samiksha
10.	Sanskriti Panchbhawe	7447613155		Sanskriti

Signature of:

Programme In-charge

IQAC Coordinator,
CO ORDINATOR

INTERNAL QUALITY ASSURANCE CELL
DHARAMPETH, M. P. DEO MEMORIAL &
SCIENCE COLLEGE, NAGPUR

Principal
Principal

Dharampeth M.P. Deo Memorial
Science College, Nagpur.



DHARAMPETH M. P. DEO MEMORIAL SCIENCE COLLEGE,
North Ambazari Road, Near Ambazari Lake, Nagpur- 440033

DATA VALIDATION & VERIFICATION (DVV)

11	Samiksha N. Khandekar	9145253759	samikshakhandekar@gmail.com	<u>Samiksha</u>
12	Kaustubh R. Ramteke	7218487714	ramtel@kaustubhr2002@gmail.com	<u>Ramteke</u>
13	Vaishnavi R. Chandekar	7249882964	vaishnavichandekar000@gmail.com	<u>Chandekar</u>
14	Shiwani S.R. Dwivedi	8855900546	ShiwaniDwivedi41@gmail.com	<u>Shiwani</u>
15	Shreyansh S. Naikwar	7447644189	shreyanshnaikwar7@gmail.com	<u>Naikwar</u>
16	Rinam C. Wankhede	840966529	wankhedorinam07@gmail.com	<u>Wankhede</u>
17	Sankanti S. Panikhar	7447613185	sankantipantikhar49@gmail.com	<u>Sankanti</u>
18	Angushi Shukla	9373665043	angushishukla2812002@gmail.com	<u>Shukla</u>
19	Rakhi P. Yedam	7378312504	yedamrakhi2000@gmail.com	<u>Rakhi</u>
20	Rani B. Katwale	8011247038	bkmaris11@gmail.com	<u>Katwale</u>
21	Jayashree D. Hiwase	7385473157	Jubhihiwase10@gmail.com	<u>J.D. Hiwase</u>
22	Sakshi P. Mankar	8180816539	sakshi2018mm@gmail.com	<u>Mankar</u>
23	Rishakha G. Gaurhade	7620351270	rishakha2020gg@gmail.com	<u>R.G.</u>
24	Ranjali L. Dande	9325473318	dandehranjali1@gmail.com	<u>R.Dande</u>
25	Avanti A. Chiphkase	7875173847	avanti1011@gmail.com	<u>Avanti</u>
26	Geswini Bhagat	7558367848	chandakbhagat45@gmail.com	<u>Bhagat</u>

Signature of

Programme In-charge

IQAC Coordinator

CO ORDINATOR

INTERNAL QUALITY ASSURANCE CELL
DHARAMPETH, M. P. DEO MEMORIAL &
SCIENCE COLLEGE, NAGPUR

Principal
Principal

Dharampeth M.P. Deo Memorial
Science College, Nagpur.



DHARAMPETH M. P. DEO MEMORIAL SCIENCE COLLEGE,
North Ambazari Road, Near Ambazari Lake, Nagpur- 440033

DATA VALIDATION & VERIFICATION (DVV)

27	Astha Sakharwal	9405197842	asthasakharwal@gmail	Astha Sakharwal
28	Roshani M. Bambal	9325853408	roshanizaisbt@gmail.com	Roshani
29	Anushri S. Wale	8530178433	anushri.wale@gmail	Anushri Wale
30	Anjali R. Pali	7498102109		
31	Gayli S. Lokhande	9356413804	sayali.lokhande2910@gmail.com	Lokhande
32	Buman A. Singh	7249465307	misumanstn@gmail.com	Buman
33	Sonam M. Upgade	9890230462	upradesonam@gmail.com	Suprade
34	Suslita S. Pwiti	7507489390	SuslitaPwiti224@gmail.com	Suslita
35	Anjali R. Misra	8319948106		Anjali
36	Priyanka L. Gujwar	9579263881	Priyankagujwar2000@gmail.com	Priyanka

Signature of:

Programme In-charge

IQAC Coordinator

CO ORDINATOR
INTERNAL QUALITY ASSURANCE CELL
DHARAMPETH, M. P. DEO MEMORIAL &
SCIENCE COLLEGE, NAGPUR

Principal

Principal

Dharampeth M.P. Deo Memorial
Science College, Nagpur.



DHARAMPETH M. P. DEO MEMORIAL SCIENCE COLLEGE, NAGPUR
INTERNAL QUALITY ASSURANCE CELL (IQAC)

Activity Report

Date: 22, DEC 2022

Name of Organizing Department or Committee: BOTANY DEPARTMENT

Name of the activity: Morphological adaptation in plants

Suggested CRITERION point if any: CRITERION-I

Date of Activity: 10th Nov., 2022

Place of Activity: DHARAMPETH M.P. DEO MEMORIAL SCIENCE COLLEGE

Name of Guest Speaker/s or Judge/s or Chief Guest/s if any: NA

Title of the Activity: To study Plant showing morphological adaptations.

Number of Participants: 34

Name of the Teacher In-charge / Convener: Dr. Mrs. Reshma Hiwase

Names of other Committee Members / Staff: Dr. Chandrakumar Patle, Mr. Amol Pimpalshende, Dr. Mrs. Sweta Rai & Mrs. Dipali Nikure

OUTCOME of the Activity with respect to mission vision of the institute and or academics: This type of activity helpful to students to understand the adaptation of plant life in various environments such desert, aquatic and terrestrial habitats. The morphological characters are such as phylloclades in *Opuntia*, Phyllode in *Acaciaauriculiformis*, stipules modification in *Acacia nilotica*, respiratory roots (Pneumatophores) in saline habitat plants.

Activity with newspaper coverage if any: NA

Activity data save in PC of: Prof. Pitambar Humane's Laptop

Dr. Reshma Hiwase
Name & Signature of Teacher In-charge

Prof. Pitambar Humane
IQAC Coordinator
CO ORDINATOR
INTERNAL QUALITY ASSURANCE CELL
DHARAMPETH, M. P. DEO MEMORIAL &
SCIENCE COLLEGE, NAGPUR

Dr. Akhilesh Peshwe
Principal
Principal
Dharampeth M.P. Deo Memorial
Science College, Nagpur.



DHARAMPETH M. P. DEO MEMORIAL SCIENCE COLLEGE,
North Ambazari Road, Near Ambazari Lake, Nagpur- 440033

DATA VALIDATION & VERIFICATION (DVV)

Name of the Programme : To study the plants showing morphological
Date of the Programme : 10th Dec 2022
Name of Chief Guest if any : _____
Name of Guest Speaker if any : _____

Sr. No.	Name of the Participant	Mobile Number	E-mail Id	Signature
1.	Kaustubh R. Paritake	7218487714	1paritakekaustubh2002@gmail.com	(KParitake)
2.	Vaishnavi R. Chandekar	72498 82964	vaishnavichandekar00@gmail.com	(VChandekar)
3.	Balraj Mangru Wadga	9420396682	balrajwadga@gmail.com	(B.Wadga)
4.	Asha Shamrao Landge	9322231581	ashalandge01@gmail.com	(A.Landge)
5.	Neha Ravindra Khawase	8766738340	neha2002kk@gmail.com	(N.Khawase)
6.	Krushnali Sanjay Kady	8625854995	krushnalikady67@gmail.com	(K.Kady)
7.	Bhumika D. Chedje	8830391103	bhumikachedge@gmail.com	(B.Chedje)
8.	Vivek R. Wankhede	8956482591	vivekwankhede09@gmail.com	(V.Wankhede)
9.	Madhura U. Bhondwe	8767484914	madhuraabhondwe@gmail.com	(M.Bhondwe)
10.	Rinam Wankhede	8010966529	Wankhede.rinam7@gmail.com	(R.Wankhede)
11.	Samiksha R. Choudhary	7517090406	choudharysamiksha26@gmail.com	(S.Choudhary)

Signature of:

Programme In-charge

Signature of IQAC Coordinator

CO ORDINATOR

INTERNAL QUALITY ASSURANCE CELL
DHARAMPETH, M. P. DEO MEMORIAL &
SCIENCE COLLEGE, NAGPUR

Signature of Principal

Principal

Dharampeth M.P. Deo Memorial
Science College, Nagpur.



DHARAMPETH M. P. DEO MEMORIAL SCIENCE COLLEGE,
North Ambazari Road, Near Ambazari Lake, Nagpur- 440033

DATA VALIDATION & VERIFICATION (DVV)

12	Shivani S.R. Dwivedi	8855900546	shivani.dwivedi41@gmail.com	Shivani
13	Shreyansh S. Naikwar	7447844189	shreyansh.naikwar7@gmail.com	Shreyansh
14	Rinam C. Wankhede	8010966529	wankhede.rinam07@gmail.com	Rinam
15	Sankranti S. Panichkhan	7447613185	sankranti.panichkhan44@gmail.com	Sankranti
16	Ayushi Shukla	9373668043	ayushishukla28112002@gmail.com	Ayushi
17	Sakshi V. Chamate	7709204933	chamate.sakshi24@gmail.com	Sakshi
18	Meunali R. Sonare	9850163812	sonare.meunali16@gmail.com	Meunali
19	Neha A. Waghade	7249895144	nehawaghade16082002@gmail.com	Neha
20	Aspita T. Dakhale	8010866758	aspitadakhale02@gmail.com	Aspita
21	Rukhi P. Gedum	7378312504	gedumrukhi000@gmail.com	Rukhi
22	Kani B. Khatwale	9011247032	kanib1112@gmail.com	Kani
23	Jayashree D. Hiwase	7385473157	Jelhihiwase10@gmail.com	J.D. Hiwase
24	Sakshi P. Mankar	8180816539	sakshi2018mm@gmail.com	Sakshi
25	Vishakha G. Brawhade	7620351270	vishakha2009@gmail.com	Vishakha
26	Beonjali L. Dande	9323478318	dandebeonjali6@gmail.com	Beonjali
27	Avanti A. Chaphekar	7875173847	avanti1011@gmail.com	Avanti

Signature of:

Programme In-charge

IQAC Coordinator

CO ORDINATOR
INTERNAL QUALITY ASSURANCE CELL
DHARAMPETH, M. P. DEO MEMORIAL &
SCIENCE COLLEGE, NAGPUR

Principal

Principal
Dharampeth M.P. Deo Memorial
Science College, Nagpur.



DHARAMPETH M. P. DEO MEMORIAL SCIENCE COLLEGE,
North Ambazari Road, Near Ambazari Lake, Nagpur- 440033

DATA VALIDATION & VERIFICATION (DVV)

28	Aatha Sakharwade	9405197842	aathasakharwade@gmail.com	Aathasakharwade
29	Dhawini Bhagat	7558367348	chandabhagat456@gmail.com	chandabhagat
30	Rashmi M. Bumbal	9325853408	Rashmiz01866@shri.com	Rashmi
31	Arushi S. Wele	8530778433	arushiswele@gmail.com	Arushi
32	Amyali R. Pali	7498102109	amyaliPali@gmail.com	Amyali
33	Suman, A. Singh.	7249465307	misssumansingh@gmail.com	Suman
34	Sayali S. Lokhande	9356413804	SayaliLokhande@gmail.com	Sayali

Signature of:

Programme In-charge

IQAC Coordinator

COORDINATOR

INTERNAL QUALITY ASSURANCE CELL
DHARAMPETH, M. P. DEO MEMORIAL &
SCIENCE COLLEGE, NAGPUR

Principal
Principal

Dharampeth M.P. Deo Memorial
Science College, Nagpur.



DHARAMPETH M. P. DEO MEMORIAL SCIENCE COLLEGE, NAGPUR
INTERNAL QUALITY ASSURANCE CELL (IQAC)

Activity Report

Date: 22nd, DEC 2022

Name of Organizing Department or Committee: BOTANY DEPARTMENT

Name of the activity: Vermicompost

Suggested CRITERION point if any: CRITERION-1

Date of Activity: 10th Nov., 2022

Place of Activity: DHARAMPETH M.P. DEO MEMORIAL SCIENCE COLLEGE

Name of Guest Speaker/s or Judge/s or Chief Guest/s if any: NA

Title of the Activity: To study practice vermicompost

Number of Participants: 30

Name of the Teacher In-charge / Convener: Dr. Mrs. Reshma Hiwase

Names of other Committee Members / Staff: Dr. Chandrakumar Patle, Mr. Amol Pimpalshende, Dr. Mrs. Sweta Rai & Mrs. Dipali Nikure

OUTCOME of the Activity with respect to mission vision of the institute and or academics: Vermicompost practice has important role in fertility of agricultural land. Vermicompost enhance soil fertility and soil has better aeration, porosity and water retention capacity. Organic matter improved for better crop yield.

Activity with newspaper coverage if any: NA

Activity data save in PC of: Prof. Pitambar Humane's Laptop

Dr. Reshma Hiwase

Name & Signature of Teacher In-charge

Prof. Pitambar Humane
IQAC Coordinator

CO ORDINATOR

INTERNAL QUALITY ASSURANCE CELL
DHARAMPETH, M. P. DEO MEMORIAL &
SCIENCE COLLEGE, NAGPUR

Dr. Akhilesh Peshwe
Principal
Principal

Dharampeth M.P. Deo Memorial
Science College, Nagpur.



DHARAMPETH M. P. DEO MEMORIAL SCIENCE COLLEGE,
North Ambazari Road, Near Ambazari Lake, Nagpur- 440033

DATA VALIDATION & VERIFICATION (DVV)

Name of the Programme : To practice vermicompost
Date of the Programme : 10 Nov 2022
Name of Chief Guest if any : _____
Name of Guest Speaker if any : _____

Sr. No.	Name of the Participant	Mobile Number	E-mail Id	Signature
1.	Krushnali Sanjay kadu	8625854995	krushnalikadug7@gmail.com	
2.	Bhumika D. Chedge	8830391103	bhumikachedge@gmail.com	
3.	Vivek R. Waghmare	8956482591	vivek.waghmare88@gmail.com	
4.	Madhura U. Bhandare	8767484114	madhura.bhandare@gmail.com	
5.	Neha R. Khelwase	8766798940	neha2002kk@gmail.com	
6.	Asha Shamrawandge	9322231581	asharandge0601@gmail.com	
7.	Kaustubh R. Ramteke	7218487714	ramtekekaustubh2001@gmail.com	
8.	Vaishnavi R. Chandekar	7249882964	vaishnavichandekar1000@gmail.com	
9.	Babji M. Neelole	942029668	babji.neelole@gmail.com	
10.	Samiksha R. Choudhary	7517090406	choudharysamiksha26@gmail.com	
11.	Samiksha N. Kundekar	9145253758	-	-

Signature of:

Programme In-charge

IQAC Coordinator

COORDINATOR

INTERNAL QUALITY ASSURANCE CELL
DHARAMPETH M. P. DEO MEMORIAL &
SCIENCE COLLEGE, NAGPUR

Principal

Principal

Dharampeth M.P. Deo Memorial
Science College, Nagpur.



DHARAMPETH M. P. DEO MEMORIAL SCIENCE COLLEGE,
North Ambazari Road, Near Ambazari Lake, Nagpur- 440033

DATA VALIDATION & VERIFICATION (DVV)

11.	Samiksha N. Kunderkar	9145253758	samikshakunderkar@gmail.com	<u>Sunderkar</u>
12.	Rinam Wankhede	8010966529	wankhedeirinam07@gmail.com	<u>Rinam</u>
13.	Shivani Dusiwedi	8855900546	shivanidusiwedi@gmail.com	<u>Shivani</u>
14.	Shreyansh S. Naikwar	7447846189	shreyanshnaikwar1@gmail.com	<u>Shreyansh</u>
15.	Rinam Wankhede	8010966529	wankhedeirinam07@gmail.com	<u>Rinam</u>
16.	Sankanti S. Panikbhave	7447613185	sankanti.panikbhave43@gmail.com	<u>Sankanti</u>
17.	Ayushi Shukla	9373668043	ayushishukla2002@gmail.com	<u>Ayushi</u>
18.	Rakhi P. Gedam	7378312505	gedamrakhi2000@gmail.com	<u>Rakhi</u>
19.	Rani B. Katurale	9011247022	krani8112@gmail.com	<u>Rani</u>
20.	Sakshi P. Mankar	8180816539	sakshi2018mmmm@gmail.com	<u>Mankar</u>
21.	Vishakha G. Grawhade	7620351270	vishakha.2020gg@gmail.com	<u>Vg.</u>
22.	Pranjavi C. Dandekar	3325473317	dandekarpranjavi@gmail.com	<u>P.Dandekar</u>
23.	Avanti Achapherkar	7875173847	avantion@gmail.com	<u>Avanti</u>
24.	Astha Sakhasame	9405197842	asthasakhasame@gmail.com	<u>Asthasame</u>
25.	Chardebhagat	7558367348	chardebhagat45@gmail.com	<u>Chardebhagat</u>
26.	Roshani Bamba	9325853408	roshanizol8th@gmail.com	<u>Roshani</u>

Signature of:

PKinwat

Programme In-charge

PKinwat

IQAC Coordinator

CO ORDINATOR

INTERNAL QUALITY ASSURANCE CELL
DHARAMPETH M. P. DEO MEMORIAL &
SCIENCE COLLEGE, NAGPUR

Principals

Principal

Principal

Dharampeth M.P. Deo Memorial
Science College, Nagpur.



DHARAMPETH M. P. DEO MEMORIAL SCIENCE COLLEGE, NAGPUR
INTERNAL QUALITY ASSURANCE CELL (IQAC)

Activity Report

Date: 18/11/2022

Name of Organizing Department or Committee:

Name of the activity: Seminar

Suggested CRITERION point if any: _ Criteria VI

Date of Activity: 10 November to 17th November 2022

Place of Activity: Chemistry Department Laboratory

Name of Guest Speaker/s or Judge/s or Chief Guest/s if any: Nil

Title of the Activity: Student seminar for B. Sc Sem V

Number of Participants: 145

Name of the Teacher In-charge / Convener: Dr Vaishali Meshram

Names of other Committee Members / Staff: Nil

OUTCOME of the Activity with respect to mission vision of the institute and or academics:

Due to seminar students prepared the topic well which is very important for exam point of view and they have developed their skill for the presentation and confidence.

Activity with newspaper coverage if any: Nil

Activity data save in PC of:

Note: Kindly share geotag photographs separately along with report on iqacdsc2022@gmail.com



Prof. Pitambar Humane
IQAC Coordinator

CO ORDINATOR
INTERNAL QUALITY ASSURANCE CELL
DHARAMPETH, M. P. DEO MEMORIAL &
SCIENCE COLLEGE, NAGPUR

Name & Signature of Teacher In-charge

Dr. Akhilesh Peshwe
Principal

PRINCIPAL
Dharampeth M.P. Deo Memorial
Science College, Nagpur-440033

B.Sc (Sem-V)



DHARAMPETH M. P. DEO MEMORIAL SCIENCE COLLEGE,
North Ambazari Road, Near Ambazari Lake, Nagpur- 440033

DATA VALIDATION & VERIFICATION (DVV)

Name of the Programme : Students Seminars B.Sc. Sem V

Date of the Programme : _____

Name of Chief Guest if any : _____

Name of Guest Speaker if any : _____

Sr. No.	Name of the Participant	Mobile Number	E-mail Id	Signature
1)	Manish. B. Gunde	9370329857	manishgunde79@gmail.com	M Gunde
2)	Tanmay Y. Chaudhari	8600102341	tchoudhari8600@gmail.com	Tan
3)	Tisha D. Kature	9021541048	tishakature@gmail.com	Tisha
4)	Bhargavi A. Sambare	7709403806	bhargavisambaros@gmail.com	Bhargavi
5)	Shruti M Pawale	9527988707	shrutipawale001@gmail.com	Shruti Pawale
6)	Nandini S. Hadge	9370301679	nandinihadge17@gmail.com	N Hadge
7)	Karmi M. Gunde	7758058514	karmigunde2905@gmail.com	Karmi Gunde
8)	Anjali P. Pali	7498102109	paliangall546@gmail.com	Anjali
9)	Shreyansh S. Naikwar	7447844189	shreyanshnaikwar27@gmail.com	Shreyansh Naikwar
10)	Ishika S. Thakre	8010907069	ishithakre22@gmail.com	Ishika
11)	Madhura U. Bhandare	8767484914	MadhuraBhandare@gmail.com	Madhura

Signature of: [Signature]
Programme In-charge

[Signature]
COORDINATOR
IQAC Coordinator
INTERNAL QUALITY ASSURANCE CELL
DHARAMPETH, M. P. DEO MEMORIAL &
SCIENCE COLLEGE, NAGPUR

[Signature]
PRINCIPAL
Dharampeth M.P. Deo Memorial
Science College, Nagpur-440033

15/11/22



DHARAMPETH M. P. DEO MEMORIAL SCIENCE COLLEGE,
North Ambazari Road, Near Ambazari Lake, Nagpur- 440033

DATA VALIDATION & VERIFICATION (DVV)

S.N.	Name of participants	mobile no.	Email id.	Signature
1)	Aditi Dhoble	8847709571	aditidhoble4@gmail.com	
2)	Raksha Dhote	7498511875	rakshadhote3@gmail.com	
3)	Pallavi y. Bhagat	9022654940	Pallaviy2208@gmail.com	
4)	Priyanshi P. Singh	7219259020	priyanshisingh17040@gmail.com	
5)	Chaitali M. Buxbade	9359540894	chaitali20206@gmail.com	
6)	Anushka D. Des	7058933157	ad04092001@gmail.com	
7)	Akanksha R. Yelure	8767935524	akankshayelure@gmail.com	
8)	Nikita G. Ekre	7972140515	clerenikita344@gmail.com	
9)	Mukesh Oraon	7249339568	oraonm64@gmail.com	
10)	Sakshi Moon	7745827736	sakshim3030@gmail.com	
11)	Sakshi V. Chamate	7709206933	chamatesakshi29@gmail.com	
12)	Saniya P. Naik	9370570457	saniyanai51@gmail.com	
13)	Vanshika C. Yede	7558244609	Vanshikayede1@gmail.com	
14)	Sonam M. Upgrade	9890230462	upgrade_sonam@gmail.com	
15)	Sushila S. Puroh	7507439390	sushilapuroh22@gmail.com	
16)	Neha R. Khetwase	8766738340	neha2002kk@gmail.com	

Signature of:

Programme In-charge

CO ORDINATOR

INTERNAL QUALITY ASSURANCE CELL
DHARAMPETH, M. P. DEO MEMORIAL &
SCIENCE COLLEGE, NAGPUR

PRINCIPAL
Dharampeth M.P. Deo Memorial
Science College, Nagpur-440033



DHARAMPETH M. P. DEO MEMORIAL SCIENCE COLLEGE,
North Ambazari Road, Near Ambazari Lake, Nagpur- 440033

DATA VALIDATION & VERIFICATION (DVV)

S.N.	Name of participants	Mobile no.	Email id	Signature
1]	Shreyash R. Chavhan	9307580971	shreyashr@gmail.com	
2]	Asha. S. Landge	932231581	ashalandge@ceolga@gmail.com	Asha. S. Landge
3]	Nikita R. Rahangdale	9307723308	nikitarahangdale2005@gmail.com	Nikita Rahangdale
4]	Divya T. Bondre	8668454925	divyabondre9@gmail.com	Divya
5]	Sakshi S. Geeri	9529660277	sakshigscicce@gmail.com	Sakshi
6]	Neha. A. Waghade	7249895144	nehawaghade16082002@gmail.com	Neha Waghade
7]	Mrunali P. Sonsare	9850163812	sonsarermrunali16@gmail.com	Mrunali
8]	Rashmi M. Babbar	9325853408	rashmi2018bb@gmail.com	Rashmi
9]	Shruti A. Kulkole	9075232517	Shruti.kulkole13@gmail.com	S. Kulkole
10]	Nikita D. Shebe	9021019101	nikita.shebe2019@gmail.com	Nikita
11]	Aachal S. Wagh	9579643389	aachal.wagh2003@gmail.com	Aachal
12]	Sufriya Patle	7757871925	patlesufriya012@gmail.com	Patle
13]	Damini M. Bondbuche	8275105785	bondbuchedamini@gmail.com	D. Bondbuche
14]	Manali S. Shinde	7249637434	manalishinde062@gmail.com	M S
15]	PRAGYA R JHA	9665852975	pragya997@gmail.com	Pragya

Signature of:

Programme In-charge

COORDINATOR
INTERNAL QUALITY ASSURANCE CELL
DHARAMPETH, M. P. DEO MEMORIAL &
SCIENCE COLLEGE, NAGPUR

PRINCIPAL

Dharampeth M. P. Deo Memorial
Science College, Nagpur-440033



DHARAMPETH M. P. DEO MEMORIAL SCIENCE COLLEGE,
North Ambazari Road, Near Ambazari Lake, Nagpur- 440033

DATA VALIDATION & VERIFICATION (DVV)

S.N.	Name of participants	Mobile no.	Email id	Signature
1.	Aarti B. Bisen	8767549078	aartibisen129@gmail.com	Aarti Bisen
2.	Suhani P. Indurkar	9370419064	suhaniindurkar@990@gmail.com	Suhani Indurkar
3.	Aarju S. Patle	7887934824	aarjupatle2002@gmail.com	Aarju Patle
4.	Aishwarya A. Joshi	7498328662	aishwaryajoshi2003@gmail.com	Aishwarya Joshi
5.	Arpita D. Gaydhane	9527250282	arpitagaydhane@gmail.com	Arpita Gaydhane
6.	Sadalparman A. Shetkh	9673410404	shetkhsadal924@gmail.com	Sadalparman A. Shetkh
7.	Nandlul p. paunpkar	9764359642	nandlulpapunpkar@gmail.com	Nandlul p. paunpkar
8.	Vishal Kumar Singh	9610187923	singhvishal9602@gmail.com	Vishal Kumar Singh
9.	Kartik Adlakhia	8530597159	k.adlakhia@gmail.com	Kartik Adlakhia
10.	Amit J. Walde	9168496253	amitwalde440divya@gmail.com	Amit J. Walde
11.	Shreyash. Prakash. Gharode	9673215962	shreyashshreyash08@gmail.com	Shreyash Gharode
12.	Nitin L. Harin Khede	9561179324	harinkhede.vijay@gmail.com	Nitin L. Harin Khede
13.	Kshitij S. Akrapalijwar	9834397158	shyamakrapalijwar927@gmail.com	Kshitij S. Akrapalijwar
14.	Saurabh K. Shukla	7721802706	Shmsaurabh77@gmail.com	Saurabh K. Shukla
15.	Anup B. Dhadhe	9730860336	anupdhadhe12345@gmail.com	Anup B. Dhadhe
16.	Priyanshu B. Singh	7775800561	singhpriyanshu0786@gmail.com	Priyanshu B. Singh

Signature of:

[Signature]
Programme in-charge

[Signature]
CO-ORDINATOR
INTERNAL QUALITY ASSURANCE CELL
DHARAMPETH, M. P. DEO MEMORIAL &
SCIENCE COLLEGE, NAGPUR

[Signature]
PRINCIPAL
Dharampeth M. P. Deo Memorial
Science College, Nagpur-440033



DHARAMPETH M. P. DEO MEMORIAL SCIENCE COLLEGE,
North Ambazari Road, Near Ambazari Lake, Nagpur- 440033

DATA VALIDATION & VERIFICATION (DVV)

S.N.	Name of participant	contact no.	Email id	Signature
1	Bhumika D. chedje	8830391103	bhumikachedje@gmail.com	<i>Bchedje</i>
2	Krushnali S. Kachle	8625854995	krushnaliach46@gmail.com	<i>Kachle</i>
3	Vivek R. Wakhurwade	8956082531	vivek.wakhurwade@gmail.com	<i>Vivek</i>
4	Samiksha R. Chaudhari	7517090406	choudharysamiksha26@gmail.com	<i>Sfm</i>
5	Samiksha N. Kundekar	9145253758	samikshakundekar@gmail.com	<i>Kundekar</i>
6	Sayli S. Lokhande	9356413804	saylilokhande2910@gmail.com	<i>Lokhande</i>
7	Muskan H. Sheikh	8055474633	muskan2019555@gmail.com	<i>Msheikh</i>
8	Shivani G. Bhute	9309900209	bhuteshivani895@gmail.com	<i>Sbhute</i>
9	Rosi. N. Patthan	8669595198	Rosikhan6622@gmail.com	<i>R Patthan</i>
10	Jayashree D. Hiwase	7385473157	Juhihiwase10@gmail.com	<i>J.D. Hiwase</i>
11	Arpita T. Dakhale	8010866758	arpitadakhale02@gmail.com	<i>Dakhale</i>
12	Priyanka L. Gujwar	9579263881	priyankagujwar2000@gmail.com	<i>Priyanka</i>
13	Amisha B. Anle	9767618394	amishanle2004@gmail.com	<i>Amisha</i>
14	Ayushi Shukla	9373668043	ayushishukla28112002	<i>Ayushi</i>
15	Rinam C Wankhede	8010966529	wankhederinam07@gmail.com	<i>Rwankhede</i>
16	Suman A. Singh	7249465307	sumansingh3@gmail.com	<i>Suman</i>
17	Anjali R. Mishra	8379948106		<i>Anjali</i>

Signature of:

P. P. Mishra

Programme In-charge

CO ORDINATOR
IOAC COORDINATOR
INTERNAL QUALITY ASSURANCE CELL
DHARAMPETH, M. P. DEO ME
SCIENCE COLLEGE, NAGPUR

PRINCIPAL

Dharampeth M.P. Deo Memorial
Science College, Nagpur-440033



DHARAMPETH M. P. DEO MEMORIAL SCIENCE COLLEGE,
North Ambazari Road, Near Ambazari Lake, Nagpur- 440033

DATA VALIDATION & VERIFICATION (DVV)

1)	Anjali. R. Mishra	9879948106	am38654@gmail	Anjali
2)	Sakshi V. Chamate	7709204893	chamate.sakshidc@gmail.com	Sakshi
3)	Rakhi. P. Gedam	7378312509	gedamrakhi@gmail.com	Rakhi
4)	Neha. A. Waghade	7249895144	nehawaghade16082002@gmail.com	Naghad
5)	Laxmi G. Sayam	7517799675	Sayamlaxmi389@gmail.com	Laxmi
6)	Tejal Mankar	9922458697	tejalmankar933@gmail.com	TRIAL
7)	Priyanka L. Gujwal	9549263881	priyankagujwal2000@gmail.com	Priyanka
8)	Amisha R. Anle	8767618396	amv1016@gmail.com	Amisha
9)	Meunali R. Sonbare	9850163812	Sonbaremeunali16@gmail.com	Meunali
10)	Aparna S. Bhute	9356964121	aparnha2006@gmail.com	Aparna
11)	Jayashree D. Hiwase	7385473157	Jshihiwase10@gmail.com	J.D. Hiwase
12)	Arpita T. Dakhale	8010866758	arpitadakhale02@gmail.com	Dakhale
13)	Kartik Adakchia	8530599159	k.adakchi@gmail	Kartik
14)	Mogha Fulwar	8605399606	moghafulwar@gmail.com	Mogha
15)	Vaishnavi Chandekar	7249882964	vaishnavij@gmail.com	Chandekar
16)	Anshuman G. Sharma	8625024400	anshuman@gmail.com	Anshuman

Signature of:

Programme In-charge

IQAC Coordinator
CO ORDINATOR
INTERNAL QUALITY ASSURANCE CELL
DHARAMPETH, M. P. DEO MEMORIAL &
SCIENCE COLLEGE, NAGPUR

Principal
PRINCIPAL
Dharampeth M.P. Deo Memorial
Science College, Nagpur-440038



DHARAMPETH M. P. DEO MEMORIAL SCIENCE COLLEGE,
North Ambazari Road, Near Ambazari Lake, Nagpur- 440033

DATA VALIDATION & VERIFICATION (DVV)

Name of the Programme : B.sc sem V Seminar (chemistry)
Date of the Programme : 12/11/2022
Name of Chief Guest if any : -
Name of Guest Speaker if any : -

Sr. No.	Name of the Participant	Mobile Number	E-mail Id	Signature
1	Anjali R. Pali	749810209	pali.anjali44@gmail.com	
2	Anshu Wale	8530778433	anshuwale2000@gmail.com	
3	Anshuman Sharma	9370892462	anshumansharma804@gmail.com	
4	Kaustik Dalakha	8530597159	kaustikdalakha@gmail.com	
5	Vishal Kumar Singh	9610187223	singhvishal9602@gmail.com	
6	Chetan Kamthe	9632727160	kanthechetan6@gmail.com	
7	Krushnali's Kodu	8625854995	krushnalikodu67@gmail.com	
8	Bhumnika chedge	8830391103	bhumnikachedge@gmail.com	
9	Vivek Wahurwagh	8956482591	vivekwahurwagh59@gmail.com	
10	Rinam C Wankhede	8010966529	wankhedeirinam@gmail.com	

Signature of:

Programme In-charge

COORDINATOR
INTERNAL QUALITY ASSURANCE CELL
DHARAMPETH, M. P. DEO MEMORIAL &
SCIENCE COLLEGE, NAGPUR

Head
Department of Chemistry
Dharampeth M. P. Deo Memorial
Science College, Nagpur-440033
PRINCIPAL



DHARAMPETH M. P. DEO MEMORIAL SCIENCE COLLEGE,
North Ambazari Road, Near Ambazari Lake, Nagpur- 440033

DATA VALIDATION & VERIFICATION (DVV)

11	Shivani S.R. Dwivedi	8855900546	shivani.dwivedi46@gmail.com	<i>Shivani</i>
12	Ayushi . O. Shukla	9373668043	ayushishukla28112002@gmail.com	<i>Ayushi</i>
13	Samiksha R. Choudhary	7517090406	choudharysamiksha26@gmail.com	<i>Samiksha</i>
14	Samiksha N. Kurdekar	9145253758	samikshakurdekar@gmail.com	<i>Samiksha</i>
15	Madhura U. Bhondure	8767484914	madhura.bhondure@gmail.com	<i>Madhura</i>
16	Nikita . R. Rahangdale	9307723308	nikitarahangdale2005@gmail.com	<i>Nikita</i>
17	Divya T. Bondre	8668454925	divyabondre3@gmail.com	<i>Divya</i>
18	Astha A. Sakharwade	9405197842	asthasakharwade@gmail.com	<i>Astha</i>
19	Avanti . A. Chaphekar	7875173847	avanti1011@gmail.com	<i>Avanti</i>
20	Adesh Hatwar	7517431102	adesh.hatwar2002@gmail.com	<i>Adesh Hatwar?</i>
21	Aarju S. Patle	7887934824	Aarjupatle2002@gmail.com	<i>Aarju</i>
22	Shreyansh. Naikwar	7447244189	shreyanshnaikwar7@gmail.com	<i>Shreyansh</i>
23				

Signature of:

Programme In-charge

COORDINATOR
INTERNAL QUALITY ASSURANCE CELL
DHARAMPETH, M. P. DEO MEMORIAL &
SCIENCE COLLEGE, NAGPUR

Principal
Dharampeth M.P. Deo Memorial
Science College, Nagpur-440033



DHARAMPETH M. P. DEO MEMORIAL SCIENCE COLLEGE,
North Ambazari Road, Near Ambazari Lake, Nagpur- 440033

DATA VALIDATION & VERIFICATION (DVV)

1.	Kattika M. Deshmukh	Sem I F-15	9649720960	Kattikamd20@gmail.com
2.	Mahi. S. Thaware	Sem I F-15	9960629566	thawaremahis7@gmail.com
3.	Siddhi. B. Jiwari	Sem I F-15	8087143696	siddhitiwari0721@gmail.com
3.4	Umang. Wadhi	Sem I F-15	9322428500	umangwadhi@gmail.com
5.	Kavishma. N. Prasad	Sem I F-8	9309318667	Navendra.prasad72@gmail.com
6.	Ritika. R. Sandhuja	Sem I - F-15	9175581655	ritikasandhuja@gmail.com
7.	Ashalesha Khadgi	Sem I - (CBZ) F11	7820929579	Ashalesha.khadgi@gmail.com
8.	Gunjan J. Bhoyar	Sem I - (CBZ) F11	7666799586	gunjanbhoyar01@gmail.com
9.	Valdehi Thote	Sem I - (CBZ) F15	7558499191	valdehitote11@gmail.com
10.	Anjali Meshram	Sem I (CBZ) F14	7767905772	anjali.meshram2021@gmail.com
11.	Meenal chowdhary	Sem I (CBZ) F14	9529014604	meenachowdhary2008@gmail.com
12.	Dhanashri Neware	Sem I (CBZ) F14	9369909913	dhanashrineware186@gmail.com
13.	Abhay Tembhere	Sem I (CBZ) F11	8975363145	abhay230102@gmail.com
K.	Aakasha. K. Kholagade	Sem I (CBZ) F11	7972228707	atanakholagade7@gmail.com

Signature of:

Programme In-charge

CO-ORDINATOR
INTERNAL QUALITY ASSURANCE CELL
DHARAMPETH, M. P. DEO MEMORIAL &
SCIENCE COLLEGE, NAGPUR

PRINCIPAL
Dharampeth M.P. Deo Memorial
Science College, Nagpur-440033



DHARAMPETH M. P. DEO MEMORIAL SCIENCE COLLEGE,
North Ambazari Road, Near Ambazari Lake, Nagpur- 440033

DATA VALIDATION & VERIFICATION (DVV)

Batch:- T-13

Date:- 15/11/22

Name of the Programme : Seminar B.Sc. sem V [CBM]
Date of the Programme : 15/11/22 - - -
Name of Chief Guest if any : -
Name of Guest Speaker if any : -

Sr. No.	Name of the Participant	Mobile Number	E-mail Id	Signature
1.	Ayushi Shukla	9373668043	ayushishukla28112002	
2.	Anusthi S. Wale	8530778433	anusthiwale2001@gmail	
3.	Shreyansh. Naitware	7447844189	shreyanshnaitware7@ku	
4	Rinani C wankhede	8010966529	wankhedeirinani04@gmail	
5.	Duman. A. Singh.	9249465307	missumay singh30@gmail - CBM	

Signature of:

Programme In-charge

COORDINATOR
INTERNAL QUALITY ASSURANCE CELL
DHARAMPETH, M. P. DEO MEMORIAL &
SCIENCE COLLEGE, NAGPUR

PRINCIPAL
Dharampeth M.P. Deo Memorial
Science College, Nagpur-440033



DHARAMPETH M. P. DEO MEMORIAL SCIENCE COLLEGE, NAGPUR

INTERNAL QUALITY ASSURANCE CELL (IQAC)

Activity Report

Date: 10/11/2022

Name of Organizing Department or Committee: Department of Physics

Name of the activity: NEP based Demonstration Activity for B.Sc. Semester III

Suggested CRITERION point if any: Restricted to RTMNU B.Sc. physics syllabus.

Date of Activity: 10/11/2022

Place of Activity: Physics Laboratory

Name of Guest Speaker/s or Judge/s or Chief Guest/s if any: NA

Title of the Activity: Demonstration of IC voltage regulation

Activity with newspaper coverage if any: No

Number of Participants: B.Sc. Semester III Students - 53

Name of the Teacher In-charge / Convener: Dr. Nayana Sonwane

Names of other Committee Members / Staff: N.A.

OUTCOME of the Activity with respect to academics:

Using this activity students get acquainted with the electronic circuits for voltage regulation, necessary to avoid the fluctuations in the output voltage w.r.t input voltage. The circuit was made up using the components such as transformer, rectifier, filter, and regulating IC. The IC 7805 was used for the purpose of regulation where the first, second, and third pin of IC was connected to the input, ground, and output in the circuit respectively. The output was measured using multimeter.

DVV: Enclosed.

Activity data save in PC of: Lt. Dr. P. W. Ambekar

Prof. Pitambar Humane
IQAC Coordinator

CO ORDINATOR
INTERNAL QUALITY ASSURANCE CELL
DHARAMPETH, M. P. DEO MEMORIAL &
SCIENCE COLLEGE, NAGPUR

Name & Signature of Teacher In-charge
HEAD
DEPARTMENT OF
Dharampeth M. P. Deo Memorial
Science College, Nagpur

Dr. Akhilesh Peshwe
Principal
Principal
Dharampeth M.P. Deo Memorial
Science College, Nagpur.



DHARAMPETH M. P. DEO MEMORIAL SCIENCE COLLEGE NAGPUR

Department of Physics

Class: B.Sc. Sem.- III

NEP ACTIVITY

Paper- 1

Unit- IV

Name of the Teacher: D.S.N. Sawane

Date: 10/11/22

Title of Activity: Demonstration of IC Voltage Regulation

Sr. No.	Name of Student	Batch	Mobile No.	Email ID	Signature
---------	-----------------	-------	------------	----------	-----------

1.	Kajal Tilakdhari Prasad	S-8	7410763132	prasad2004@gmail.com	<u>Prasad</u>
2.	Shruti Ramtame	S-9	8851031895	shruti1981@gmail.com	<u>Shruti</u>
3.	Mansi Ashok Budale	S-8	7196308467	mansibudale@gmail.com	<u>Mansi</u>
4.	Kajal P. Nighat	S-8	9373250623	kajalnighat2000@gmail.com	<u>Nighat</u>
5.	Atharav P. Wante	S-5	9284641511	atharav.p@gmail.com	<u>Wante</u>
6.	Ayush R. Basilrao	S-5	9519445092	ayushbasilrao@gmail.com	<u>Ayush</u>
7.	Jansaj Demital Patil	S-8	9370820325	jansajpatil142@gmail.com	<u>Patil</u>
8.	Mansi S. Fating	S-8	8767154686	mansifating2110@gmail.com	<u>Fating</u>
9.	Atharva Vinod Ingule	S-7	922418136	atharvavindod27@gmail.com	<u>Ingule</u>
10.	Ritul K. Bisen	S-5	7028810840	ritulbisen06@gmail.com	<u>Bisen</u>
11.	Shweta Bedwal	S-5	5090440154	shwetabedwalbase@gmail.com	<u>Bedwal</u>
12.	Anuj Mishra	S-5	8103656208	anujmishra2502@gmail.com	<u>Anuj</u>
13.	Asmin K. Sheikh	S-3	8668323588	asmin029@gmail.com	<u>Sheikh</u>
14.	Priyanka S. Shah	S-3	7385197265	ps3247311@gmail.com	<u>Priyanka</u>
15.	Shraddha B. Roje	S-10	7876804083	shraddharoje46@gmail.com	<u>Roje</u>
16.	Simran Talmolle	S-10	7922530337	simranaltalme@gmail.com	<u>Talme</u>
17.	Aaravya F. Molghe	S-7	72021885	aaravyamolgha@gmail.com	<u>Molgha</u>
18.	Apurva S. Verulkar	S-7	9623613911	apurvasverulkar@gmail.com	<u>Verulkar</u>
19.	Aditi Kute	S-5	7820812303	aditkute19@gmail.com	<u>Kute</u>
20.	Nupur Sharma	S-8	9322042250	nupursharma858@gmail.com	<u>Sharma</u>
21.	Damini Katar	S-9	8208255685	daminikatar@gmail.com	<u>Katar</u>
22.	Sanchita Patil	S-5	7218079074	sanchitapatil2003@gmail.com	<u>Patil</u>
23.	Bhagyashree Thakre	S-5	8766925275	thakrebhagyashree@gmail.com	<u>Thakre</u>
24.	Nutan Surjare	S-5	8805570279	nutansurjare2@gmail.com	<u>Surjare</u>
25.	Aditi Kute	S-5	7820812303	aditkute161@gmail.com	<u>Aditi</u>
26.	Chetan Bhopche	S-3	9172484628	chetanbhopche27@gmail.com	<u>Bhopche</u>
27.	Komal Patil	S-5	9887768500	komalpatil234@gmail.com	<u>Patil</u>
28.	Prakhar Bhatkar	S-3	8329760853	prakharpbhatkar@gmail.com	<u>Bhatkar</u>
29.	Komal Digrao	S-5	8010274803	komaldigrao@gmail.com	<u>Digrao</u>

Signature of Teacher

Head of Department

- 30) Prachin R. Kotrallikar S-9 7495102097 prachinrallikar@gmail.com Prachin
- 31) Adityakumar Shukla S-5 9518994638 adityashukla2025@gmail.com Aditya
- 32) Nitin Keshwaha S-5 9693429005 nitinkeshwaha705@gmail.com Nitin
- 33) Divya Hanote S-8 8605422901 divyahanote0406@gmail.com Divya
- 34) ~~Nupur Sharma S-8~~
- 35) ~~Prachin~~
- 34) Bhumika V. Thakre S-2 7218247917 bhumikathakre55@gmail.com Bhumika
- 35) Vrushali K. Shahare S-1 9307516332 vrushalishahare21@gmail.com Vrushali
- 36) Ashmit N. Jumar S-7 8080238101 ashmitjumar@gmail.com Ashmit
- 37) Swanandidharne S-10 7420880982 swanandidharne31@gmail.com Swanandi
- 38) Ruchika Padle S-9 8669335907 ruchikopadle4@gmail.com Ruchika
- 39) Rushali D. Bhoskar S-9 8579485537 rushalibhoskar24@gmail.com Rushali
- 40) Pawan S. Vishwakarma S-3 7038408869 pawanshivsharma84@gmail.com Pawan
- 41) Dhammapati Lale S-7 9975037356 dhammapatiraj@gmail.com Dhammapati
- 42) Akshay Khondare S-5 7350956809 akshaykhondare79@gmail.com Akshay
- 43) Omkumar D. Devangan S-5 9763624388 ommumasi12@gmail.com Omkumar
- 44) Hitesh G. Kaware S-5 7058427112 hiteshkaware73@gmail.com Hitesh
- 45) Hejike. Mishra S-1 9067445777 kumerianandharmil7010@gmail.com Hejike
- 46) Aditya Kumar Singh S-5 7350543901 adityasingh28818@gmail.com Aditya
- 47) Dinesh Purtele S-7 9623389676 purteledinesh51@gmail.com Dinesh
- 48) Ayaz M. Sheikh S-7 8767355503 ayazsheikh9068@gmail.com Ayaz
- 49) Rohit S. Wanjari S-9 7741061907 wrohit031@gmail.com Rohit
- 50) Pratik D. Lilhare S-9 9307480269 pratiklilhare3@gmail.com Pratik
- 51) Mitallam Prasad S-8 7558719534 pmithilam343@gmail.com Mitallam
- 52) Vaishu Sahadeonimje S-9 9579993869 vaishusahadeonimje2@gmail.com Vaishu
- 53) Vatan S. Sowwane S-9 9975410765 Vatan



INTERNAL QUALITY ASSURANCE CELL (IQAC)

Activity Report

Date: 11/11/2022

Name of Organizing Department or Committee: Department of Physics

Name of the activity: NEP based Demonstration Activity for B.Sc. Sem-V

Suggested CRITERION point if any: Restricted to RTMNU BSc physics syllabus.

Date of Activity: 11/11/2022

Place of Activity: Room no. 004

Name of Guest Speaker/s or Judge/s or Chief Guest/s if any: NA

Title of the Activity: Demonstration Comparative chart for Metal, Semiconductor and insulator

Activity with newspaper coverage if any: No

Number of Participants: BSc Sem-V Students - 14

Name of the Teacher In-charge / Convener: Mr. Nishant Zode

Names of other Committee Members / Staff: N.A.

OUTCOME of the Activity with respect to academics:

This demonstration provided an opportunity to BSc Sem-V students to learn the Comparative chart for Metal, Semiconductor and Insulator. The main difference between the conductor, semiconductor & insulator is in its conduction state. The conductors always conduct electric current while the insulators do not conduct. However, semiconductor conducts & blocks at different conditions. The comparison of values at zero kelvin and room temperature were studied.

DVV: Enclosed.

Activity data save in PC of: Lt. Dr. P. W. Ambekar

Prof. Pitambar Humane
IQAC Coordinator

CO ORDINATOR
INTERNAL QUALITY ASSURANCE CELL
DHARAMPETH, M. P. DEO MEMORIAL &
SCIENCE COLLEGE, NAGPUR

HEAD
DEPARTMENT OF PHYSICS
Dharampeth M. P. Deo Memorial
Science College, Nagpur

Dr. Akhilesh Peshwe
Principal

Principal
Dharampeth M.P. Deo Memorial
Science College, Nagpur



DHARAMPETH M. P. DEO MEMORIAL SCIENCE COLLEGE, NAGPUR
INTERNAL QUALITY ASSURANCE CELL (IQAC)

NEP Activity Report

Date : 14/11/23

Name of Organizing Department or Committee: Department of Chemistry

Name of the activity: NEP Activity Home Science Sem I Unit II

Suggested CRITERION point if any: Criteria II

Date of Activity: 11/11/22

Place of Activity: Home Science department 2nd floor

Name of Guest Speaker/s or Judge/s or Chief Guest/s if any: Nil

Title of the Activity: Different Types of Alloy used in Kitchen

Number of Participants: 17

Name of the Teacher In-charge / Convener: Dr. Sandip Madhukar Bhiwagade

Names of other Committee Members / Staff: Dr. Vaishali P. Meshram

OUTCOME of the Activity with respect to mission vision of the institute and or academics:

.This activity helps to understand students helps the student to identify different types of alloys used in Kitchen, Why alloys are superior to pure metals, Why alloys are generally more resistance to corrosion, what are application of alloys in day today life what is mean by ferrous and nonferrous alloy.

Activity with newspaper coverage If any : Nil

Activity data save in PC of: Department of Chemistry



Dr. Sandip M. Bhiwagade
Bhiwagade

Prof. Pitambar Humane
IQAC Coordinator

Name & Signature of Teacher In-charge

Dr. Akhilesh Peshwe
Principal

CO ORDINATOR
INTERNAL QUALITY ASSURANCE CELL
DHARAMPETH, M. P. DEO MEMORIAL &
SCIENCE COLLEGE, NAGPUR

PRINCIPAL
Dharampeth M.P. Deo Memorial
Science College, Nagpur-440033

Date: 11/11/22



DHARAMPETH M. P. DEO MEMORIAL SCIENCE COLLEGE,
North Ambazari Road, Near Ambazari Lake, Nagpur- 440033.

DATA VALIDATION & VERIFICATION (DVV)

Name of the Programme : NEP Activity (Different kind of Alloys used in kitchen)
 Date of the Programme : 11/11/22
 Name of Chief Guest if any : _____
 Name of Guest Speaker if any : _____

Sr. No.	Name of the Participant	Mobile Number	E-mail Id	Signature
1.	Tejasvini Rewade	7796027056	tejasrewade803@gmail.com	
2.	Shubhankar G. Hirkare	9579092931	shubhankarhirkare1234@gmail.com	
3.	Kalpna D. Sunagpure	9579236712	Kalpanasunagpure7890	
4.	Shubhankar Wikey	702943177	shubhankarwikey157@gmail.com	
5.	Kimaya Kale	8866073792	kimayakale003@gmail.com	
6.	Tanee S. Korde	7841384450	kordetanree33@gmail.com	
7.	Vaishnavi Pradhan	9763169560	pradhanvaishnavi157@gmail.com	
8.	Shrushti Patkar	7387067403	ShrushtiPatkar@gmail.com	
9.	Bhagyashree S. Ambule	9359139068	ambuleb667@gmail.com	
10.	Pallavi B. Katar	8459277408	pratoe573@gmail.com	

Signature of:
 11) Priya K. Khawshi
 10) Rachli N. Laxkar

9763617224 Priyakhawshi8@gmail.com
 8806244419 Rachilaxkar158@gmail.com

Programme In-charge

IQAC COORDINATOR
CO ORDINATOR
 INTERNAL QUALITY ASSURANCE CELL
 DHARAMPETH, M. P. DEO MEMORIAL SCIENCE COLLEGE, NAGPUR

Principal
PRINCIPAL
 Dharampeth M.P. Deo Memorial Science College, Nagpur-440033

13) Mansi N. Chaudhary 7720088783

chaudharymansiq21@gmail.com

Mansi

14) Riya U. Maity 7350980367

maityriya23@gmail.com

Riya

15) Avani S. Shenwai 9096507459

avanishenwai15@gmail.com

Avani

16) Jasvi Wankhede 8767699751

wankhedejasvi@gmail.com

Jasvi

17) Pragya Tiwari 6394098386

Pragyatiwari14052003@gmail.com

Pragya



DHARAMPETH M. P. DEO MEMORIAL SCIENCE COLLEGE, NAGPUR
INTERNAL QUALITY ASSURANCE CELL (IQAC)

Activity Report

Name of Organizing Department or Committee:

Name of the activity: Paragraph Writing Competition

Suggested CRITERION point if any: Criteria V

Date of Activity: 11-11-2022

Place of Activity: College

Name of Guest Speaker/s or Judge/s or Chief Guest/s if any: Nil

Title of the Activity: Paragraph Writing Competition

Number of Participants: 06

Name of the Teacher In-charge / Convener: Dr.Mrs.Shraddha Deshpande

Names of other Committee Members / Staff: Dr.Akhilesh Peshwe (Principal)

OUTCOME of the Activity with respect to mission vision of the institute and or academics:

Students were asked to write paragraph based on different topics. They learnt content gathering, analysing, organising and presenting it in the form of paragraphs.

Activity with newspaper coverage if any: Nil

Activity data save in PC of: English Department,

Prof. Pitambar Humane
IQAC Coordinator

CO ORDINATOR
INTERNAL QUALITY ASSURANCE CELL
DHARAMPETH, M. P. DEO MEMORIAL &
SCIENCE COLLEGE, NAGPUR

Dr. Mrs. Shraddha Deshpande
Teacher Incharge

Dr. Akhilesh Peshwe
Principal
Dharampeth M.P. Deo Memorial
Science College, Nagpur.



Dharampeth M.P. Deo Memorial Science College, Nagpur
Department of English

NOTICE

Academic Session 2022-2023

PARAGRAPH WRITING COMPETITION



All the students are hereby informed that English Department is organizing **Paragraph Writing Competition** on the following topics:

- Gifts of Science
 - Person, I admire the most
 - Visit to a historical place
 - Importance of Social Service
-
- Paragraph should be in English language and of 150-200 words.
 - Paragraph should be submitted on **11th November 2022** at 11.30 a.m in Home Science Department.



Dr. Shraddha Deshpande

Head,

Department of English

13/10/22

Dr. Shraddha Deshpande
Head, Department of English
Dharampeth M.P. Deo Memorial
Science College, Nagpur

Paragraph writing



DHARAMPETH M. P. DEO MEMORIAL SCIENCE COLLEGE,
North Ambazari Road, Near Ambazari Lake, Nagpur- 440033

DATA VALIDATION & VERIFICATION (DVV)

(Hec.)

1.	Aditi R. Vaidya	9075714591	aditivaidya619@gmail.com	AR
2.	Ashwini N. Pandey	8308621072	ashwinipandey229@gmail.com	Ashwini
3.	Prerna J. Chaudhari	7620384149	chaudhariprerna294@gmail.com	Prerna
4.	Neha R. Vishwakarma	8983534175	Nehavishwakarma2023@gmail.com	Neha
5.	Anshikha U. Jaiswarakar	9021391207	anshikhajaiswarakar@gmail.com	Anshikha
6.	Gayatri N. Verma	9763287531	gayatriverma@gmail.com	Gayatri

(Signature)

(Signature)

Signature of:

Dr. Shraddha Deshpande
Head, Department of English
Dharampeth M.P. Deo Memorial
Science College, Nagpur

IQAC Co-ordinator
Dharampeth M.P. Deo Memorial
Science College, Nagpur-440033

PRINCIPAL
Dharampeth M.P. Deo Memorial
Science College, Nagpur-440033



Activity Report

Date: 30.11.22

Name of Organizing Department or Committee: Home Science Department

Name of the activity: Demonstration of Fashion maker, how to use it and an Industry tailoring Unit with its operating mechanism.

Suggested CRITERION point if any: criteria 2 & 5

Date of Activity: 11.11.22

Place of Activity: Department of Home Science

Name of Guest Speaker/s or Judge/s or Chief Guest/s if any:

Mrs Pratiksha Mandale

Title of the Activity: Demonstration of working of Singer Fashion Maker

Number of Participants: 18

Name of the Teacher In-charge / Convener: Dr Shraddha Deshpande and Mrs M Deshpande

Names of other Committee Members / Staff: Entire teaching Staff of Home Science.

OUTCOME of the Activity with respect to mission vision of the institute and or academics:
Updated Knowledge & techniques of latest equipments in fashion industry.

Rotary Club ,Nagpur have donated the Sewing Machines (10 in number) With the mission to highlight women Empowerment & income generation aspects amongst girl Students .In this light few training programmes would be a part of regular feature in near future to satisfy this mission .

Activity with newspaper coverage if any: NA

Activity data save in PC of: Mrs M Deshpande

Note: Kindly share geotag photographs separately along with report on iqacdsc2022@gmail.com

COORDINATOR
INTERNAL QUALITY ASSURANCE CELL
DHARAMPETH M. P. DEO MEMORIAL &
SCIENCE COLLEGE, NAGPUR
Prof. Pitambar Humane

11.11.22
Name & Signature of Teacher In-charge

PRINCIPAL
DHARAMPETH M. P. DEO MEMORIAL
SCIENCE COLLEGE, NAGPUR
Dr. Akhilesh Peshwe

Workshop On Working of Fashion Maker

Date:- 11/11/2022



DHARAMPETH M. P. DEO MEMORIAL SCIENCE COLLEGE,
North Ambazari Road, Near Ambazari Lake, Nagpur- 440033

DATA VALIDATION & VERIFICATION (DVV)

1.	Sushmita Mallick	9887916560	sushmitt10@gmail.com	Sushmita
2.	Aarti Raut	8625813189	araut46@gmail.com	A Raut
3.	Prenci Chaudhari	7620384149	chaudhasiprencia294@gmail.com	Prenci Chaudhari
4.	Anshikha Jaiswarakar	9021391207	anshikhajaiswarakar@gmail.com	Anshikha
5.	SAKSHI CHAKONDE	7843018801	sakshichakonde@gmail.com	Sakshi Chakonde
6.	Neha R. Vishwakarma	9975846970		Neha
7.	Shalu Pordhi	8329115380		Shalu
8.	Aditi Vaidya	9075714591	aditivaidya19@gmail.com	Aditi
9.	Bhavana Guwadasoni	888437303	bhavanaguwadasoni@gmail.com	Bhavana
10.	Minal Patle	735730164		Minal
11.	Grishma Sonule	7620842550	grishmasonule@gmail.com	Grishma
12.	Ananya Meghde	9284834439	ananyameghde@gmail.com	Ananya
13.	Vaishnavi Bahadure	9284679244	vaishnavibahadure34@gmail.com	Vaishnavi
14.	Sakshi Thosar	8177911360	sakshithosar62@gmail.com	Sakshi
15.	Nayuni Mali	9067028172	NayuniMali92@gmail.com	Nayuni

Signature of:

Program In-charge

COORDINATOR
INTERNAL COORDINATOR
SHARAMPETH, M. P. DEO MEMORIAL &
SCIENCE COLLEGE, NAGPUR

Principal A1

Dharampeth M. P. Deo Memorial
Science College, Nagpur-440033



Activity Report

Date: 12th November 2022

Name of Organizing Department or Committee: Electronics Department
Name of the activity: Guest Lecture
Suggested CRITERION point if any: Suggested criteria II
Date of Activity: 12th November 2022

Place of Activity: Electronics Lab,

Name of Guest Speaker/s or Judge/s or Chief Guest/s if any: Mr. Abhijeet Kshirsagar,
Shri Mathuradas Mohota Science College, Nagpur.

Title of the Activity: Guest Lecture

Number of Participants: 27

Name of the Teacher In-charge / Convener: Mrs. Leena P. Thakare

OUTCOME of the Activity with respect to mission vision of the institute and or academics:

➤ Report

Guest Lecture for Sem I and Sem III was conducted by Department of Electronics, Dharampeth M. P. Deo Memorial Science College, Nagpur on 12th November 2022 from 1.00 pm to 2.30 pm. The objective of taking this lecture was to aware the students about the Amplifiers and Oscillators. The Guest Speaker was Mr. Abhijeet Kshirsagar, Shri Mathuradas Mohota Science College, Nagpur. He Spoke on topic " Instruments for Waveform Generation". The speaker explained the basics of Amplifiers, Barkhausen Criterion, Different types of Oscillators. After the lecture, the students were given time to interact with the speaker. Students felt that the lecture was more informative and interactive. The Guest was introduced by Simran Dhimole, student of sem I. Formal vote of thanks was given by Mrs. Leena P. Thakare.



IQAC Co-ordinator

Dharampeth M. P. Deo Memorial
Science College, Nagpur-440013

Prof. Pitambar Humane
IQAC Coordinator

Prof. Varsha V. Rangari
Head of the Department

Dr. Akhilesh Peshwe
Principal
Dharampeth M. P. Deo Memorial
Science College, Nagpur-440013



**Dharampeth M. P. Deo Memorial Science College,
Nagpur
Department of Electronics**

Appreciation Letter

Date: 12th November 2022

To,
Mr. Abhijeet Kshirsagar,
Assistant Professor,
Shri Mathuradas Mohota Science college,
Nagpur.

Dear Sir,

On behalf of Department of Electronics, Dharampeth M. P. Deo Memorial Science College, Nagpur, I would like to appreciate you for accepting our invitation to be Resource person for guest lecture. I appreciate your efforts to prepare and deliver presentation on "**Instruments for Generation of Waveforms**" for Our first- and second-year electronics students to be held on 12th November 2022

Once again, thank you and we appreciate your continued support.

Sincerely,

Dr. Varsha V. Rangari
Professional & Head
Department of Electronics
Dharampeth M.P. Deo Memorial
Science College, Nagpur



Dharampeth M. P. Deo Memorial Science College,
Nagpur
Department of Electronics

Invitation Letter

Date: 7th November 2022

To,
Mr. Abhijeet Kshirsagar,
Assistant Professor,
Shri Mathuradas Mohota Science college, Nagpur.

Subject: Invitation letter to be Resource Person for Guest Lecture.

Dear Sir,

Its give me immense pleasure to invite you to be the Resource Person for Guest Lecture in our department on "**Instruments for Generation of Waveforms**" for Our first- and second-year electronics students to be held on 12th November 2022. It will be very kind of you if you accept our invitation for the same.

Thank You,

Accepted
07/11/2022

Abhijeet Kshirsagar

Dr. Varsha V. Rangari
Professor & Head
Department of Electronics
Dharampeth M.P. Deo Memorial
Science College, Nagpur



DHARAMPETH M. P. DEO MEMORIAL SCIENCE COLLEGE,
North Ambazari Road, Near Ambazari Lake, Nagpur-440033

DATA VALIDATION & VERIFICATION (DVV)

Name of the Programme : Guest Lecture on "Instruments for Generation of waveforms"
 Date of the Programme : 12th November, 2022
 Name of Chief Guest if any : _____
 Name of Guest Speaker if any : Mr. Abhijeet Kshirsagar

Sr. No.	Name of the Participant	Mobile Number	E-mail Id	Signature
1.	Simran Khimale	7666330683	simrandhimala80@gmail.com	
2.	TANU . H. JINGH	8806855808	tanusingh69492@gmail.com	
3.	Tejas Dongre	9322578918	Tj9874@gmail.com	
4.	Ved.S. Choudhary	7498572706	vedchoudhary1276@gmail.com	
5.	Jay Anilbhau Patil	7385436956	jay.patil326@gmail.com	
6.	Uday . C. Baghose	8483542609	baghoseuday@gmail.com	
7.	Rohit Kawade	9359525716	KawadeRohit19@gmail.com	
8.	Ankush . S. Gunde	8080004076	agund3@gmail.com	
9.)	vaithae A. Gangeel	7507907178	gangeelvaithae@gmail.com	
10)	Tom Waghmare	8855919474	ishanwaghmare9474@gmail.com	

Signature of:

Programme In-charge

IQAC Coordinator

INTERNAL QUALITY ASSURANCE CELL
DHARAMPETH, M. P. DEO MEMORIAL &
SCIENCE COLLEGE, NAGPUR

Principal

Dharampeth M.P. Deo Memorial
Science College, Nagpur.



DHARAMPETH M. P. DEO MEMORIAL SCIENCE COLLEGE,
North Ambazari Road, Near Ambazari Lake, Nagpur- 440033

DATA VALIDATION & VERIFICATION (DVV)

11)	Bhagyashali D. Chavare	7796434177	sakshinidare2017@gmail.com	B. Chavare
12)	Tushal R. Achare	9075995617	achartushal5@gmail.com	Tushal
13)	Abhishek R. Singh	8208348103	abhi0832005@gmail.com	Singh
14)	Vedant O. Umasthakar	9049932753	umasthakarvedant@gmail.com	Vedant
15)	Chetan V. Popche	9172484628	chetanpopche27@gmail.com	Popche
16)	Mangsi D. Nandanwar	7709322027	mangsinandanwar1@gmail.com	M. Nandanwar
17)	Sakshi V. Kharde	8806934839	sakshikharde30@gmail.com	Sakshi
18)	Urvashi S. Umasthakar	8177373253	umasthakaruvashi@gmail.com	U. Umasthakar
19)	Priyanka S. Shah	4385197365	rs324711@gmail.com	Priyanka
20)	Alismin K. Sheikh	8665322558	alismin06@gmail.com	A. Sheikh
21)	Tushar S. Wadhwa	7038980231	anjaliwadhw@gmail.com	Tushar
22)	Jayvi A. Kharakra	7888116270	jayvikesarkar@gmail.com	Jayvi
23)	Bhagyawathi Pandey	9175302601	pandeybhagyawathi@gmail.com	B. Pandey
24)	Sachin M. Potlhi	7276017322	sachinpotlhi91@gmail.com	S. Potlhi
25)	Urvashi C. Chopde	9022627617	urvashichopde2002@gmail.com	U. Chopde
26)	Jyesh R. Madhkar	7020883421	JyeshMadhkar@gmail.com	J. Madhkar

Signature of:

Programme In-charge

IQAC Coordinator
CO ORDINATOR
INTERNAL QUALITY ASSURANCE CELL
DHARAMPETH, M. P. DEO MEMORIAL &
SCIENCE COLLEGE, NAGPUR

Principal
Dharampeth M.P. Deo Memorial
Science College, Nagpur.



**DHARAMPETH M. P. DEO MEMORIAL SCIENCE COLLEGE, NAGPUR
INTERNAL QUALITY ASSURANCE CELL (IQAC)**

Activity Report

Date: 16/11/2022

Name of Organizing Department or Committee: Entrepreneurship Development Cell

Name of the activity: A guest Lecture

Suggested CRITERION point if any: II and V

Date of Activity: 15/03/2023

Place of Activity: Dr. Abdul Kalam Hall

Name of Guest Speaker/s or Judge/s or Chief Guest/s if any: Dr. Jaldeep Bhansali,
Mindcrafter Horiba,

Title of the Activity: "Career Opportunities in Health Sector" A guest Lecture by
Expert from HORIBA.

Number of Participants: 40 (Sem II, IV, VI)

Name of the Teacher In-charge / Convener: Dr. Mrs. Vidya R. Kathoke

Names of other Committee Members / Staff:

**OUTCOME of the Activity with respect to mission vision of the institute and or
academics:**

It helps to motivate the students to set up their goals, and helps to become courageous if
unsuccessful in one goal can proceed for another goal.

Such lectures help to increase confidence and courage of students in selecting goals and also
help to remove their confusion.

Activity with newspaper coverage if any:

https://m.facebook.com/story.php?story_fbid=pfbid0ap6rp431KzPVD6kNUF8avHVyN3n4WX8DpXqCBCqaHDXDRGfu5kHLfbRHpXA91g8oi&id=100064142527382&mibextid=Nif5oz



Note: Kindly share geotag photographs separately along with report on

iqacds-2022@gmail.com

Prof. Pitambar Humane
IQAC Coordinator

CO ORDINATOR
INTERNAL QUALITY ASSURANCE CELL
DHARAMPETH, M. P. DEO MEMORIAL &
SCIENCE COLLEGE, NAGPUR

vekat hake
Name & Signature of Teacher In-charge

Dr. Akhilesh Peshwe
Principal

Principal
Dharampeth M. P. Deo Memorial
Science College, Nagpur



Dharampeth M.P. Deo Memorial science College, Nagpur
Academic Session: 2022-2023
DEPARTMENT OF MICROBIOLOGY

Date: 14/03/2023

NOTICE

All dear student a guest Lecture on "Career opportunities in Health Sector" was arranged tomorrow with HORIBA at 2.00 pm in Abdul kalam hall on Wednesday 15/03.2023. All should join the program positively.

Venue: APJ Abdul Kalam Hall
Date: 15th March 2023
Time: 2.00 pm

Kathoke
Head

Department of Microbiology

Dr. V. R. Kathoke
Head

Deptt. of Microbiology
Dharampeth M.P. Deo Memorial
Science College, Nagpur.

Principal
Dharampeth M.P. Deo Memorial
Science College, Nagpur.



Nagpur, Maharashtra, India
105, Ambazari Rd, near Ambazari, Kasturba Layout, Lake Mouza,
Ambazari, Nagpur, Maharashtra 440033, India
Lat 21.131292°
Long 79.047751°
15/03/23 01:28 PM GMT +05:30

Principal
Dharmapada Jaji College
Dharmapada Jaji College



DHARAMPETH M. P. DEO MEMORIAL SCIENCE COLLEGE, NAGPUR
Activity Report

Date: 15/03/2023

“Career Opportunities in Health Sector” A guest Lecture by Expert from HORIBA.

A Guest lecture by expert from Horiba was arranged on 15/03/2023 by Dr. Jaldeep Bhansali, Mindcrafter. He delivered a motivational speech on how to fix a goal for future. He advised them to be always positive & to have at least two to three goals so that if we become unsuccessful in one goal can courageously switch to another goal. Hard work and perseverance of a person will help to achieve goals in life.

During discussions the students asked questions to clarify their concepts and confusions about fixing goals.

The students get motivated and were happy to have such useful lecture. 40 students got benefited by this lecture.



CO ORDINATOR
INTERNAL QUALITY ASSURANCE CELL
DHARAMPETH, M. P. DEO MEMORIAL &
SCIENCE COLLEGE, NAGPUR

Principal
DHARAMPETH M. P. DEO MEMORIAL
SCIENCE COLLEGE, NAGPUR.



DHARAMPETH M. P. DEO MEMORIAL SCIENCE COLLEGE,
North Ambazari Road, Near Ambazari Lake, Nagpur- 440033

DATA VALIDATION & VERIFICATION (DVV)

Name of the Programme : A Guest lecture on 'Career Opportunities in Health Sector
Date of the Programme : 15/03/2023
Name of Chief Guest if any : Dr Jaldeep Bhansali
Name of Guest Speaker if any : Dr Jaldeep Bhansali

Sr. No.	Name of the Participant	Mobile Number	E-mail Id	Signature
1)	Anjali R. Pali	7488102109	pali.anjalis46@gmail.com	
2)	shruti Pawar	9527988707	shrutipawar001@gmail.com	
3)	Anushais Wele	8530778433	anushaiswele2001@gmail.com	
4)	Ishika S. Thakur	8010907069	ishithakur22@gmail.com	
5)	Laxmi Grade	7758058514	laxmigrade@gmail.com	
6)	Nandini Hadge	9370301670	nandinihadge11@gmail.com	
7)	Madhura Bhondwe	8767484914	MadhuraBhondwe@gmail.com	
8)	Shivani S.R. Dwivedi	8855900546	shivanidwivedi41@gmail.com	
9)	Krushnali S. Kadu	8625854995	KrushnaliKadusf@gmail.com	
10)	Astha A. Sakharwade	940597842	asthasakharwade@gmail.com	

Signature of:

Programme In-charge

COORDINATOR
INTER-UNIVERSITY ASSURANCE CELL
DHARAMPETH M. P. DEO MEMORIAL &
SCIENCE COLLEGE

Principal

Dharampeth M. P. Deo Memorial
Science College, Nagpur



DHARAMPETH M. P. DEO MEMORIAL SCIENCE COLLEGE,
North Ambazari Road, Near Ambazari Lake, Nagpur- 440033

DATA VALIDATION & VERIFICATION (DVV)

1	Manali .S. Shinde	7249637434	manalishinde062@gmail.com	
2	Suhani P. Indurkar	9370419064	suhaniindurkar90@gmail.com	
3.	Nandini p. pournikar	9764359642	nandini.pournikar@gmail.com	
4.	Srushti .M. Gaikwad	7385532705	srushtigaikwad8095@gmail.com	
5.	Aarabi B. Bisen	8767549078	aarabibisen12@gmail.com	
6.	Pranjali H. Gaikwad	9130893362	gaikwadpranjali.99@gmail.com	
7.	Arpita D. Gaydhane	9527250282	arpitagaydhane@gmail.com	
8.	Jyoti . J. Sharma	8669736380	jyotis8390@gmail.com	
9.	Siddhant . G. Hirkan	9579092931	hirkanesiddhas@gmail.com	
10.	Rinani C. Wankhede	8010966529	rinanawankhede@gmail.com	

Signature of:

Programme In-charge

COORDINATOR
INTERNAL QUALITY ASSURANCE CELL
DHARAMPETH M. P. DEO MEMORIAL &
SCIENCE COLLEGE, NAGPUR

Principal
Principal
Dharampeth M. P. Deo Memorial



**DHARAMPETH M. P. DEO MEMORIAL SCIENCE COLLEGE, NAGPUR
ROTARACT CLUB OF DMPDSVM**

Activity Report

Date: 30 /11/2022

Name of Organizing Department or Committee: ROTARACT CLUB OF DMPDSVM

Name of the activity: Voter Id Registration Camp

Suggested CRITERION point if any: Criterion III & Criterion V

Date of Activity: 12th November 2022

Place of Activity: College

Name of Guest Speaker/s or Judge/s or Chief Guest/s if any: NIL

Title of the Activity: Voter Id Registration Camp

Number of Participants: 09

Name of the Teacher In-charge / Convener: Dr.Mrs.Shraddha Deshpande

Names of other Committee Members / Staff: Rotaract Club Members

OUTCOME of the Activity with respect to mission vision of the institute and or academics:

Election commission of India offers online voter registration for Indian citizens who have attained the age of 18 on the qualifying date (1st of January of the year of revision of electoral roll). Citizen, can enroll himself/herself as General Voter and fill Form 6 online at National Voters' Service Portal. Registered voters should also check their enrollment status. This activity was held to register college students for Voter Id who are eligible for this enrollment.

Activity with newspaper coverage if any: NIL

Activity data save in PC of: Department of English



Prof. Pitambar Humane
IQAC Coordinator

CO ORDINATOR
INTERNAL QUALITY ASSURANCE CELL
DHARAMPETH, M. P. DEO MEMORIAL &
SCIENCE COLLEGE, NAGPUR

Dr. Mrs. Shraddha Deshpande
Teacher In-charge

Dr. Akhilesh Peshwe
Principal
Principal
Dharampeth M.P. Deo Memorial
Science College, Nagpur.



DHARAMPETH M.P.DEO MEMORIAL SCIENCE COLLEGE, NAGPUR

ROTARACT CLUB 22-23

Voter Id Registration Camp

12 November 2022

Rotary.org Link





DHARAMPETH M.P.DEO MEMORIAL SCIENCE COLLEGE, NAGPUR

ROTARACT CLUB 22-23

Voter Id Registration Camp

12 November 2022

List of Students

Sr.	Name	Contact Number
1	Harsh kodape	9604677672
2	AnanyaMotghare	7219218955
3	GargiHadge	7972076671
4	PrajwalBhoyar	8010434634
5	SaniaMidhatRaza	8975726700
6	VaishnaviGadge	9022976449
7	VedantBaxy	8530455796
8	AvishkarBansod	7820841788
9	KunalDigrase	8007525770

Prof. Pitambar Humane
IQAC Coordinator

CO ORDINATOR
INTERNAL QUALITY ASSURANCE CELL
DHARAMPETH, M. P. DEO MEMORIAL &
SCIENCE COLLEGE, NAGPUR

Dr. Mrs. Shraddha Deshpande
Teacher In-charge

Dr. Akhilesh Peshwe
Principal
Principal
Dharampeth M.P. Deo Memorial
Science College, Nagpur.



DHARAMPETH M. P. DEO MEMORIAL SCIENCE COLLEGE, NAGPUR
INTERNAL QUALITY ASSURANCE CELL (IQAC)
Activity Report NEP

Date: 30.11.22

Name of Organizing Department or Committee: Department of Home-Science

Name of the activity: Diet Survey on Anaemia and Malnutrition.

Suggested CRITERION point if any:

Date of Activity: 12/11/2022

Place of Activity: Online Google Survey.

Name of Guest Speaker/s or Judge/s or Chief Guest/s if any:

Title of the Activity: Online Google Survey -Diet Survey on Anaemia and Malnutrition.

Number of Participants: 19

Name of the Teacher In-charge / Convener: Mrs Pradnya Bagalkote.

Names of other Committee Members / Staff: Mrs Manju Deshpande.

OUTCOME of the Activity with respect to mission vision of the institute and or academics:

Students learnt how to make Google forms and how to do online diet survey on anemia and malnutrition.

Activity with newspaper coverage if any:

Activity data save in PC of: https://docs.google.com/forms/d/18w9qiwHa_4fPcApd06FX2-QwKv9tbrZJQ-H1YLSIAYk/edit

Note: Kindly share geotag photographs separately along with report on iqacdsc2022@gmail.com

Name & Signature of Teacher In-charge

Mrs Pradnya Bagalkote
Convener
Internal Quality Assurance Cell
Dharampeth M. P. Deo Memorial &
Science College, Nagpur

Dr. Akhilesh Peshwe
Principal
Principal
Dharampeth M.P. Deo Memorial
Science College, Nagpur.

Diet Survey on Anaemia & Malnutrition

Date:- 12/11/2022



DHARAMPETH M. P. DEO MEMORIAL SCIENCE COLLEGE,
North Ambazari Road, Near Ambazari Lake, Nagpur- 440033

DATA VALIDATION & VERIFICATION (DVV)

Google Survey

1)	Pallavi B. Katre	8459277408	pkatre573@gmail.com	Katre
2)	Bhagyashree Ambule	9175451202	ambuleb66@gmail.com	Ambule
3)	Sujata Kawase	9309079427	prnu02gh@gmail.com	Kawase
4)	Poonali Ghangadkar	9022302785	shahnammodali@gmail.com	Poonali
5)	Shahnam T. Modali	9975034151	maskearchilax@gmail.com	Shahnam
6)	Archita S. Maske	8806266619	prachilaxekar159@gmail.com	Archita
7)	Prachi N. Laxekar	9096507459	prachilaxekar159@gmail.com	Prachi
8)	Avani S. Shrivastava	8767699751	wankhede1@gmail.com	Avani
9)	Ojasvi M. Wankhede	7841384450	kordeTannu130@gmail.com	Ojasvi
10)	Tannu S. Korde	8866073792	kimayaNkale@gmail.com	Tannu
11)	Kimaya N. Kale	7350980367	malviya23@gmail.com	Kimaya
12)	Riya U. Malviya	917099216215	dy57gal@gmail.com	Riya
13)	Deepika Yechar	9763169560	pradhanavishnavi155@gmail.com	Deepika
14)	Vishnavi K. Pradhan	7387067403	shrushtiPatekar@gmail.com	Vishnavi
15)	Shrushti S. Patekar	9763617224	pryakhawshi3@gmail.com	Shrushti
16)	Pritya K. Khawshi	9145457202	pryakhawshi3@gmail.com	Pritya
17)	Sujata V. Kawade	6394098386	pryakhawshi3@gmail.com	Sujata
18)	Pragya S. Tiwari	9284237798	Pragyatiwari16052003@gmail.com	Pragya
19)	Kerinaast. Diwe		kerinaclive@gmail.com	Kerinaast

Signature of

Programme In-charge

PTS

IQAC COORDINATOR
INTERNAL QUALITY ASSURANCE CELL
DHARAMPETH M. P. DEO MEMORIAL &
SCIENCE COLLEGE, NAGPUR

Principal
Dharampeth M. P. Deo Memorial
Science College, Nagpur.



DHARAMPETH M. P. DEO MEMORIAL SCIENCE COLLEGE, NAGPUR

INTERNAL QUALITY ASSURANCE CELL (IQAC)

Activity Report

Date: 14/11/2022

Name of Organizing Department or Committee: Department of Mathematics

Name of the activity: NEP based Application of group theory for B.Sc. Semester-V

Suggested CRITERION point if any: Criterion I.

Date of Activity: 12/11/2022

Place of Activity: Class room

Name of Guest Speaker/s or Judge/s or Chief Guest/s if any: NA

Title of the Activity: Application of group theory for B.Sc. Semester-V (10)

Activity with newspaper coverage if any: No

Number of Participants: B.Sc. Semester-V Students

Name of the Teacher In-charge / Convener: Dr. N. P. Gaikwad

Names of other Committee Members / Staff: N.A.

OUTCOME of the Activity with respect to academics:

Students are very interested in group representations, especially of Lie groups. Examples of the use of groups in physics include the Standard Model, gauge theory, the Lorentz group, and the Poincaré group.

DVV: Enclosed.

Dr. N. P. Gaikwad
Name & Signature of Teacher In-charge



Prof. Pitambar Humane

IQAC Coordinator

CO ORDINATOR
INTERNAL QUALITY ASSURANCE CELL
DHARAMPETH, M. P. DEO MEMORIAL &
SCIENCE COLLEGE, NAGPUR



Dr. Akhilesh Peshwe

Principal

Principal
Dharampeth M.P. Deo Memorial
Science College, Nagpur.



DHARAMPETH M. P. DEO MEMORIAL SCIENCE COLLEGE,
North Ambazari Road, Near Ambazari Lake, Nagpur-440033

DATA VALIDATION & VERIFICATION (DVV)

Name of the Programme : NEP based Application of group
 Date of the Programme : 12/11/2022 | theory for B.Sc - Semester-V
 Name of Chief Guest if any : _____
 Name of Guest Speaker if any : _____

Sr. No.	Name of the Participant	Mobile Number	E-mail Id	Signature
1)	Shivam S. Maurya	9607873702	Shivammaurya1129.	<u>MShivam</u>
2)	Raksha D. Dhoke	7498511875	rakshadhoke3@gmail.com	<u>Raksha</u>
3)	Priyanshi P. Singh	7219259020	priyanshisingh18040@gmail.com	<u>Singh</u>
4)	Chaitali M. Burbaude	9359540394	chaitali20206@gmail.com	<u>Chaitali</u>
5)	Pallavi Y. Bhagat	9022654940	Pallaviy2208@gmail.com	<u>Bhagat</u>
6)	Anushka S. Das	7058933157	ad04092005@gmail.com	<u>Anushka</u>
7)	Aaditi Dhobke	8867709571	aditidhobke4@gmail.com	<u>Aaditi</u>
8)	Shivani G. Bhute	9302900209	bhuteshivani89@gmail.com	<u>Sbhute</u>
9)	Alkanksha R Yeluge	8767935524	alkankshayeluge@gmail.com	<u>Alkanksha</u>
10)	Janmay Bhute	7697250831	tanmaybhute900@gmail.com	<u>Janmay</u>

Signature of:

Programme In-charge

IQAC Coordinator

Dharampeth M.P. Deo Memorial
Science College, Nagpur-440033

Principal

Dharampeth M.P. Deo Memorial
Science College, Nagpur-440033



DHARAMPETH M. P. DEO MEMORIAL SCIENCE COLLEGE,
North Ambazari Road, Near Ambazari Lake, Nagpur- 440033

DATA VALIDATION & VERIFICATION (DVV)

11	Pragya R Jha	9665852975	pragya1697@gmail.com	
12	Sakshi Moon	7745827736	sakshim3030@gmail.com	
13	Nikita Ekre	9479953719	Ekrenikita851@gmail.com	
14	Khushi Aundhkar	8767219513	khushiandkar652@gmail.com	
15	Rani Kokate	7498945148	Ranikokate@gmail.com	
16	Ishwar Suryawanshi	8587577297	suryawanshi.ishwar125@gmail.com	
17	Supriya Patle	7757871925	PatlesupriyaPatle23@gmail.com	
18	Anjali Namdev Charde	8261964188	anjalicarde20@gmail.com	
19	Priyanshu Bijay Singh	7775800561	singhpriyanshu0786@gmail.com	
20	Aakash . Ashok. Sikdar	9175422051	Aakash sikdar 015@gmail.com	
21	Tanmay . Sunil Gadam	7262034396	tanmay.gadam@gmail.com	
22	Bhavesh Rameshwar Maske	7489951631	bhaveshmaske2002@gmail.com	
23	Akash Day	7972942799	akash1@gmail.com	
24	Sanchit . M. Joshi	8975706788	sanchit.joshi02@gmail.com	
25	Abhishek A. Falke	7823835535	abhi.malephalle88@gmail.com	
26	Tanvi S. Mohule	7057844882	tanvimohule@gmail.com	

Signature of

Programme In-charge

IQAC Coordinator
Dharampeth M.P. Deo Memorial
Science College, Nagpur-440033

PRINCIPAL

Dharampeth M.P. Deo Memorial
Science College, Nagpur-440033



DHARAMPETH M. P. DEO MEMORIAL SCIENCE COLLEGE,
North Ambazari Road, Near Ambazari Lake, Nagpur- 440033

DATA VALIDATION & VERIFICATION (DVV)

27	Samplesha Rabhane	9307133863	samplesha_rabhane@gmail.com	<u>Samp.</u>
28	Komal M Kumbhwar	7620314869	KumbhwarKomal94@gmail.com	<u>Komal</u>
29	Neha S. Bankar	8055477553	neha2002bankar@gmail.com	<u>Bankar</u>
30	Sahil R. Jirbode	9373414643	sahiljirbode11@gmail.com	<u>Sahil</u>
31	Megha Fulwal	8605399606	MeghaFulwal0@gmail.com	<u>Megha</u>
32	Anshuman Sharma	9370892462	anshumansharmastu@gmail.com	<u>Anshuman</u>
33	Chetan Kamthe	9637271601	KamtheChetan01@gmail.com	<u>Chetan</u>
32	Prakash Khanal	9011599643	PrakashKhanal@gmail.com	<u>Prakash</u>
33	Karthik Adlakha	8530597159	kadlakha@gmail.com	<u>Karthik</u>
34	Pranay Mahajan	7385551492	Pranaymahajan@gmail.com	<u>Pranay</u>
35	Vishal Kumar Singh	9610187023	SinghVishal9602@gmail.com	<u>Vishal</u>
36	Kshiti S. Akonpaliwar	9834397158	KshitiAkonpaliwar@gmail.com	<u>Kshiti</u>
37	Vinay R. Jaidwal	8788422101	Vinay8788422101@gmail.com	<u>Vinay</u>
37	Ankita Sonware	9579661554	AnkitaSonware10@gmail.com	<u>Ankita</u>
39	Megha Bisen	7517953260	bisenmegha@gmail.com	<u>Megha</u>
40	Pratiksha S. Umarre	9359175006	pratikshaumarre50@gmail.com	<u>Pratiksha</u>

Signature of:

Programme In-charge

IQAC Coordinator
Dharampeth M.P. Deo Memorial
Science College, Nagpur-440033

PRINCIPAL
Dharampeth M.P. Deo Memorial
Science College, Nagpur-440033



DHARAMPETH M. P. DEO MEMORIAL SCIENCE COLLEGE,
North Ambazari Road, Near Ambazari Lake, Nagpur- 440033

DATA VALIDATION & VERIFICATION (DVV)

41	Karan R. Wagnare	9325845366	karanwagnare09@gmail.com	Kwagnare
42	Samiksha R. Khasare	9604473539	srekhaskhasare@gmail.com	Skhasare
43	Diya R. Patil	7757052463	diyapatil1553@gmail.com	Dpatil
44	Pranjal D. Sawalkar	9385458510	pranjalbawalkar1234@gmail.com	Dsawalkar
45	Nikita D. Shebe	9021019101	nikita-shebe2019@gmail.com	Dshebe
46	Aachal S. Wagh	9579643389	aachalwagh2002@gmail.com	Awagh
47	Nikhil K. Jankar	8530960407	nikhiljankar@gmail.com	Njankar
48	Tanushree R. Datt	9766927406	tanushreedatt2002@gmail.com	Datt
49	VAIBHAV S. RANE	7744951383	vaidhaurane2207@gmail.com	Vran
50	Hiransha B. Lakte	7448252569	hiransha2020@gmail.com	Hlakte
51	Prachi S. Mundharpur	9856469609	prachi2020@gmail.com	Pprachi
52	Piyush G. Kopse	9873563022	kopshipiyush08@gmail.com	Pkopse
53	Uday P. Kandarkar	9545897196	udaykandarkar99@gmail.com	Ukandarkar
54	Divyani U. Dhule	7030731921	divyanidhule2002@gmail.com	Ddhule
55	Sumit Bhalchandra	5021627757	sumitbhalchandra2002@gmail.com	Sbhalchandra
56	Ravi N. Patil	8669593198	Rajikherangadga@gmail.com	Rpatil

Signature of:

Programme In-charge

IQAC Coordinator
Dharampeth M. P. Deo Memorial
Science College, Nagpur-440033

Principal

Dharampeth M. P. Deo Memorial
Science College, Nagpur-440033



DHARAMPETH M. P. DEO MEMORIAL SCIENCE COLLEGE,
North Ambazari Road, Near Ambazari Lake, Nagpur- 440033

DATA VALIDATION & VERIFICATION (DVV)

57.	Rani D. Patel	7888241794	ranipatel68091@gmail.com	Rani..
58	Adesh Harkar	7517431162	adesh.harkar@gmail.com	A.K. Harkar
59	Prachi K. Vardabhe	9325336932	Prachivardabhe@gmail.com	Vardabhe
60	Snehal Bute	7058756570	snehalbute@gmail.com	
61	Mitraj R. Chauhan	9420626335	mitrajprchauhan7102@gmail.com	Mitraj
62	Rishikesh dhet	8788199260	rishikeshdhet2002@gmail.com	Rishikesh
63	Karaj S. Dhor	88055292863	karajdhor97@gmail.com	Karaj
64.	Sakshi L. Borcupatre	8317219372	sakshizorabba@gmail.com	Sakshi
65.	Mahesh. p. Maske	9021951173	maheshmaske48@gmail.com	Maske
66	ABHIJEET-S. MANKAR	8738040642	AbhiJeet@gmail.com	Abhi
67	Ruchita S. Bhoyar	9527832686	ruchitabhoyar07@gmail.com	Ruchita

Signature of:

Programme In-charge

IQAC Coordinator

Dharampeth M.P. Deo Memorial
Science College, Nagpur-440033

**Principal
PRINCIPAL**

Dharampeth M.P. Deo Memorial
Science College, Nagpur-440033



NEP Activity Report

Date : 15/11/22

Name of Organizing Department or Committee: Department of Chemistry

Name of the activity: NEP Activity Home Science Sem I unit III

Suggested CRITERION point if any: Criteria II

Date of Activity: 12/11/22 and 14/11/2022

Place of Activity: Home Science Department 2nd floor and chemistry lab. 3rd floor

Name of Guest Speaker/s or Judge/s or Chief Guest/s if any: Nil

Title of the Activity: Use of stalagmometer to find out surface tension of liquid

Number of Participants: 24

Name of the Teacher In-charge / Convener: Dr. Sandip Madhukar Bhiwagade

Names of other Committee Members / Staff: Dr. Vaishali P. Meshram

OUTCOME of the Activity with respect to mission vision of the institute and or academics:

In this activity students learn about surface tension. Surface tension is property of liquid.

This property of liquid plays major role to clean dirt from the cloths. In this activity students learn how to measure surface tension of liquid by using of stalagmometer.

Activity with newspaper coverage if any : Nil

Activity data save in PC of: Department of Chemistry



Dr. Sandip Bhiwagade
~~Dr. Bhiwagade~~

Name & Signature of Teacher In-charge

Prof. Pitambar Humane
IQAC Coordinator

Dr. Akhilesh Peshwe
Principal

CO ORDINATOR
INTERNAL QUALITY ASSURANCE CELL
DHARAMPETH, M. P. DEO MEMORIAL &
SCIENCE COLLEGE, NAGPUR

PRINCIPAL
Dharampeth M.P. Deo Memorial
Science College, Nagpur-441117



DHARAMPETH M. P. DEO MEMORIAL SCIENCE COLLEGE,
North Ambazari Road, Near Ambazari Lake, Nagpur-440033

DATA VALIDATION & VERIFICATION (DVV)

Name of the Programme : NEP-Activity (Use of Galvanometer to find out surface tension of
Date of the Programme : 12/11/22 & 14/11/2022 liquid
Name of Chief Guest if any : _____
Name of Guest Speaker if any : _____

Sr. No.	Name of the Participant	Mobile Number	E-mail Id	Signature
1.	Amshikha U. Jaiswarkar	9021391207	amshikhajaiswarkar@gmail.com	Amshikha
2.	Prema J. Chaudhari	7620384149	chaudharprema20@gmail.com	P. Chaudhari
3.	Abhi. R. Vaideya	8075714591	abhirvaideya619@gmail.com	Abhi
4.	Ashwini N. Pandey	8308681078	ashwinipandey829@gmail.com	Ashwini
5.	Minal. L. Patle	7350730164	patleminal83@gmail.com	Minal
6.	Shalu P. Pardhi	8329115380	shalupardhi3@gmail.com	Shalu
7.	SAKSHI R. CHAKUNDE	7843018801	sakshichakunde@gmail.com	Sakshir
8.	Neha R. Vishwakarma	8883534173	nehavishwakarma85285@gmail.com	Neha
9.	Astha P. Bhowray	9156003306	asthabhowray@gmail.com	Astha
10.	Hemlata D. Verma	7517058379	vermahemlata@gmail.com	Hemlata
11.	Shubhangi R. Nishad	9518534076	shubhnishad@gmail.com	Shubhangi
12.	Gayatri N. Varma	9463287591	gayatriveerma@gmail.com	Gayatri
13.	Vaishnavi Kapse	708320089	vaishnavikapse@gmail.com	Vaishnavi
14.	Shreya Dhawale	8888261004	shreyadhawale20@gmail.com	Shreya

Signature of:
Programme In-charge

IQAC Coordinator
CO ORDINATOR
INTERNAL QUALITY ASSURANCE CELL
DHARAMPETH, M. P. DEO MEMORIAL &
SCIENCE COLLEGE, NAGPUR

Principal

PRINCIPAL

Dharampeth M.P. Deo Memorial
Science College, Nagpur-440033



DHARAMPETH M. P. DEO MEMORIAL SCIENCE COLLEGE, NAGPUR
INTERNAL QUALITY ASSURANCE CELL (IQAC)
NEP Activity Report

Date : 15/11/23

Name of Organizing Department or Committee: Department of Chemistry

Name of the activity: NEP Activity Home Science Sem I unit I

Suggested CRITERION point if any: Criteria II

Date of Activity: 12/11/22 and 14/11/2022

Place of Activity: Home Science Department 2nd floor and chemistry lab. 3rd floor

Name of Guest Speaker/s or Judge/s or Chief Guest/s if any: Nil

Title of the Activity: Identification of hard and Soft water and chemical method to estimate hardness of water

Number of Participants: 34

Name of the Teacher In-charge / Convener: Dr. Sandip Madhukar Bhiwagade

Names of other Committee Members / Staff: Dr. Vaishali P. Meshram

OUTCOME of the Activity with respect to mission vision of the institute and or academics:

This is student centric activity. In this activity students learn about different types of impurities present in water, what is mean by suspended, colloidal, floating, bacterial and chemical impurities present in water. In this activity student learn about hardness of water and how one can identify hard water and soft water by using simple soap, what is mean by temporary, permanent and harness of water and how to estimate temporary, permanent and total harness of water by using chemical method

Activity with newspaper coverage if any : Nil

Activity data save In PC of: Department of Chemistry



Dr. Sandip Bhiwagade
(Handwritten signature)

Name & Signature of Teacher In-charge

(Handwritten signature)

Prof. Pitambar Humane
IQAC Coordinator

(Handwritten signature)
Dr. Akhlesh Peshwe
Principal

CO ORDINATOR
INTERNAL QUALITY ASSURANCE CELL
DHARAMPETH, M. P. DEO MEMORIAL &
SCIENCE COLLEGE, NAGPUR

PRINCIPAL
Dharampeth M.P. Deo Memorial
Science College, Nagpur-440033



DHARAMPETH M. P. DEO MEMORIAL SCIENCE COLLEGE,
North Ambazari Road, Near Ambazari Lake, Nagpur- 440033

Date: 12/11/22

DATA VALIDATION & VERIFICATION (DVV)

Sr.No.	Name	Batch / Group	Mobile. No.	Signature
1]	Anushri S. Wele	CBM T-13	8530778433	
2]	Bhargavi A. Sambare	CZM T-15	7709403806	
3]	Waxmi M. Gaudle	CZM T-14	7758058514	
4]	Tshika S. Thakre	CZM - T-14	8010907069	
5]	Anjali R. Puli	CBM - T-13	7498102109	
6]	Shruti M. Pawar	CZM - T-15	9527988707	
7]	Manmay Y. Choudhari	CZM - T-14	8600102341	
8]	Manish. Grade	CZM - T-14	9370329857	
9]	Nandini Hagde.	CZM - T14	9370301679	
10]	Aishwarya Joshi	CZM - T15	8956169223	
11]	Shreyansh S. Naikwar	CBM - T13	7447844189	
12]	Rudesh W. Wadde	CBM - T13	8329676611	
13]	Balraj M. Wadde	CBM - T13	9420396682	
14]	Kartik Adlakha	PCM - T7	8530597159	
15]	Chetan Kamthe	PCM - T7	9637271601	
16]	Divya Gondre	PCM - T9	8668454925	
17]	Supriya Patle	PCM - T7	7757871925	

Signature of:

Programme In-Charge

IQAC Coordinator

CO ORDINATOR
INTERNAL QUALITY ASSURANCE CELL
DHARAMPETH, M. P. DEO MEMORIAL
SCIENCE COLLEGE, NAGPUR

Principal

PRINCIPAL
Dharampeth M.P. Deo Memorial
Science College, Nagpur-440033



DHARAMPETH M. P. DEC MEMORIAL SCIENCE COLLEGE,
North Ambazari Road, Near Ambazari Lake, Nagpur- 440033

DATA VALIDATION & VERIFICATION (DVV)

16.	Anshuman Sharma	PCM - T9	9370892462	<u>Anshuman</u>
17.	Mukesh Oraon	PCM - T9	7249339368	<u>Mukesh</u>
18.	Suraj B. Shende	PCM - T9	9856666487	<u>Shende</u>
19.	Saurabh K. Shukla	PCM - T8	7721802706	<u>Shukla</u>
20.	Adesh H. Hedcoor	PCM - T8	7517491102	<u>A.H. Hedcoor</u>
21.	Shivam S. Mawnya	PCM - T9	9607873702	<u>Shivam</u>
22.	Tanmay Bhatte	PCM - T10	7697250831	<u>Tanmay</u>
23.	Ashwan Surjawanishi	PCM - T9	8087317297	<u>Ashwan</u>
24.	Vishal Kumar Singh	PCM - T10	9610187223	<u>Vishal</u>
25.	Pratham P. Auptak	PCM - T10	8767275449	<u>Pratham</u>
26.	Prachi S. Waghale	PCM - T8	8767914118	<u>Prachi</u>
27.	Pragya R Jha	PCM - T8	9665852975	<u>Pragya</u>
28.	Akanksha R Yeluge	PCM - T8	8767935524	<u>Akanksha</u>
29.	Vedika P. Karanbar	PCM - T10	9145149787	<u>Vedika</u>
30.	Roji - N. Pathan	PCM - T9	8669595198	<u>R. Pathan</u>
31.	Nikita R. Rahangdale	PCM - T9	889307723308	<u>Nikita</u>
32.	Snehal A. Butke	PCM - T10	7058756570	<u>Snehal</u>

Signature of:

[Signature]
Programme In-charge

IQAC Coordinator

[Signature]
Principal



185

DHARAMPETH M. P. DEO MEMORIAL SCIENCE COLLEGE, NAGPUR
INTERNAL QUALITY ASSURANCE CELL (IQAC)
NEP Activity Report

Date : 15/11/22

Name of Organizing Department or Committee: Department of Chemistry

Name of the activity: NEP Activity Sem V Unit II Paper II

Suggested CRITERION point if any: Criteria II

Date of Activity: 12/11/22

Place of Activity: Room No. 5

Name of Guest Speaker/s or Judge/s or Chief Guest/s if any: Nil

Title of the Activity: Preparation of balloon model of different orbital

Number of Participants: 66

Name of the Teacher In-charge / Convener: Dr. Sandip Madhukar Bhiwagade

Names of other Committee Members / Staff: Dr. Vaishali P. Meshram

OUTCOME of the Activity with respect to mission vision of the institute and or academics:

This is student centric activity. This activity helps to understand students very clearly the 3D nature of the orbital which further helps the students to get better understandings of microscopic world of atoms, how duality principle works in microscopic particles like electron, how electrons arranged in the orbital, what is the meaning of positive and negative sign of which is written on the orbital. How principle of Molecular orbital Theory (MOT) works, how Molecular orbital formed.

Activity with newspaper coverage if any : Nil

Activity data save in PC of: Department of Chemistry



Prof. Pitambar Humane
IQAC Coordinator

CO ORDINATOR
INTERNAL QUALITY ASSURANCE CELL
DHARAMPETH, M. P. DEO MEMORIAL &
SCIENCE COLLEGE, NAGPUR

Name & Signature of Teacher In-charge

Dr. Akhilesh Peshwe
Principal

PRINCIPAL
Dharampeth M.P. Deo Memorial
Science College, Nagpur-440033



DHARAMPETH M. P. DEO MEMORIAL SCIENCE COLLEGE,
North Ambazari Road, Near Ambazari Lake, Nagpur- 440033

Date: 12/11/22

MO Dig. of Homo & Hetero
molecules & Preparation of balloon
Model

DATA VALIDATION & VERIFICATION (DVV)

NEP Report Submission

Sr.	Name of student	Mobile No	Email	Sign.
1.	Priyanshi Singh	7219259020	priyanshisingh18040@gmail.com	P Singh
2.	Anushka D. Das	7058933157	ado4092001@gmail.com	Anushka
3.	Nikita G. FRC	7972190515	ekscnikita300@gmail.com	Nikita
4.	Shruti A. Kukule	9075232517	Shrutikukule13@gmail.com	S. Kukule
5.	Chaitali M. Burebade	9399540394	chaitali20206@gmail.com	Chaitali
6.	Tanmay Bhute	7697250831	tanmaybhute900@gmail.com	Tanmay
7.	Akanksha R. Yelure	9730108278	akankshayelure@gmail.com	Akanksha
8.	Pragya R. Jha	9665852975	pragya9697@gmail.com	Pragya
9.	Shivam S. Mawrya	9607873702	shivamawrya@gmail.com	Shivam
10.	Vishal Kumar Singh	9610187223	singhvishal9602@gmail.com	Vishal
11.	Raksha D. Dhote	7498511875	rakshadhote3@gmail.com	R. Dhote
12.	Sakshi Moon	7745827736	sakshim3030@gmail.com	Sakshi
13.	Muskan H. Sheikh	8055474633	Muskan2019555@gmail.com	Muskan
14.	Shivani G. Bhute	9302900209	bhuteshivani855@gmail.com	Shivani

Signature of:

Programme In-charge

IQAC COORDINATOR

INTERNAL QUALITY ASSURANCE CELL
DHARAMPETH, M. P. DEO MEMORIAL &
SCIENCE COLLEGE, NAGPUR

Principal

PRINCIPAL

Dharampeth M. P. Deo Memorial
Science College, Nagpur-440033

15.	Pallavi Y. Bhagat	9022654940	Pallavim 2708@gmail.com	<u>Bhagat</u>
16.	Nikita Shebe	9021019101	nikita.shebe2019@gmail.com	<u>Nikita</u>
15.	Arpita Gaydhare	9527250282	arpitagaydhare@gmail.com	<u>Arpita</u>
16.	Akash Ashok Sirkolan	8175422051	Sirkolan akash 15@gmail.com	<u>Akash</u>
17	Kavishma S Bamsod	7369812507	KavishmaBamsod401@gmail.com	<u>Kavishma</u>
18.	Rasi. N. Pothan	8669595198	Rasiknan66024@gmail.com	<u>R Pothan</u>
19.	Rani. d. Patel	8669595198	Ranipatel12404@gmail.com	<u>Rani</u>
20.	Pranjali N. Gaikwad	9130893362	gaikwadpranjali39@gmail.com	<u>Gaikwad</u>
21.	Ishwari U. Suryawanshi	8087317297	suryawanshiishwari123@gmail.com	
22.	Aarjya S. Patle	7887934824	aarjyapatle2002@gmail.com	<u>Aarjya</u>
23	Shreuti M. Pawar	9527981707	Shreuti Pawar 0001@gmail.com	<u>Shreuti</u>
24.	Diwya T. Bondre	8668454925	diwyabondre3@gmail.com	<u>Diwya</u>
25.	Damini M. Bandbuche	8275105785	bandbuchedamini@gmail.com	<u>D. Bandbuche</u>
26	Aachal Swagh	9579643389	aachalswagh003@gmail.com	<u>Swagh</u>
27.	Ajaswini Bhagat	7558367348	shardabhagat452@gmail.com	<u>Ajaswini</u>
28.	Pranjali L. Dandale	9325973318	dandalepranjali0@gmail.com	<u>P Dandale</u>
29	Avanti. A. Chaphekar	7875173847	avanti1011@gmail.com	<u>Avanti</u>



DHARAMPETH M. P. DEO MEMORIAL SCIENCE COLLEGE,
North Ambazari Road, Near Ambazari Lake, Nagpur- 440033

DATA VALIDATION & VERIFICATION (DVV)

30	Aareti Bisen	8767484914	madhusabhadars@gmail.com	M.B.
31	Adesh .k. Hatwan	7517431162	adeshatwara2002@gmail.com	A.K. Hatwan
32	Sahil Ghodeshwar	7507999271	sahilghodeshwar@gmail.com	Sahil
33	Nikita R. Rahangdale	9307723308	nikitarahangdale2005@gmail.com	Rahangdale
34	Neha J. Chandhate	9370570833	nehachandhate246@gmail.com	N.J. Chandhate
35	Katlik Adlakha	8530597159	katlik@gmail.com	Katlik
36	Rammay Chandhari	8600102341	rchandhari8600@gmail.com	Rammay
37	Aitha Sakhaswade	9405197842	aithasakhaswade@gmail.com	Aitha
38	Manish Gonde	9370929857	manishgonde79@gmail.com	Manish
39	Krushnali S. Kerdur	8625834995	krushnali.kerdur@gmail.com	Kerdur
40	Ishita S. Thakre	8010907069	ishithakre22@gmail.com	Ishita
41	Aditi Dhoble	8847709571	aditidhoble4@gmail.com	Aditi
42	Tanushree Date	9766927405	tanushreedate2@gmail.com	Date
43	Saurabh K. Shukla	7721802706	Shusaurabh7@gmail.com	Shukla
44	Prachi S. Waghale	8767914118	Prachiwaghale1@gmail.com	Waghale
45	Shubham. S. Gupta	7038609520	shubhangupta79@gmail.com	Gupta
46	Harsh. S. Singh	9011689573	harshsingh7@gmail.com	Singh

Signature of:

Programme In-charge

IQAC Coordinator

CO ORDINATOR
INTERNAL QUALITY ASSURANCE CELL
DHARAMPETH, M. P. DEO MEMORIAL &
SCIENCE COLLEGE, NAGPUR

Principal
PRINCIPAL

Dharampeth M. P. Deo Memorial
Science College, Nagpur-440033

47	Suroj B. Shende	9356666487	Surojshende2018@gmail.com	<u>Suroj</u>
118	Kshiti J. Ahanpaliwar	9834397158	shven822@gmail.com	<u>Sh</u>
49	Vinay R. Jaiswal	8788422102	Vinay R. Jaiswal@gmail.com	<u>Vinay</u>
50	Amit J. Walde	9168496253	Amitwalde440@gmail.com	<u>Amit</u>
51	Nitin L. Hazinkhede	9561179324	hazinkhede.vijay@gmail.com	<u>Nitin</u>
52	Neha A. Waghade	7249895144	nehawaghade16082002@gmail.com	<u>NWaghade.</u>
53	Rani B. Khatke	9011247038	bkranie112@gmail.com	<u>Rani</u>
54	Rakhi P. Gedam	7378312504	gedamrakhi2000@gmail.com	<u>Rakhi</u>
55	Meunali R. Sonbaxe	9850163812	Sonbaxemeunali16@gmail.com	<u>Meunali</u>
56	Priyanka D. Bohane	7620740373	Priyankabohane9@gmail.com	<u>Priyanka</u>
57	Vaishnavi R. Chandekar	7249982964	vaishnavichandekar@gmail.com	<u>Chandekar</u>
58	Aishwarya Joshi		aishwaryajoshi@gmail.com	<u>Aishwarya</u>
59	Vedika P. Karawkar	9145143787	vedikakarawkar@gmail.com	<u>Vedika</u>
60	Anshuman Chauhan	8370992462	Anshuman Chauhan@gmail.com	<u>Anshuman</u>
61	Chetan Kauthe	9637271601	kauthechetan8@gmail.com	<u>Chetan</u>
62	Supriya Patte	9757971925	supriyapatte@gmail.com	<u>Supriya</u>
63	Megha Fulwar	8605399606	meghafulwar@gmail.com	<u>M Fulwar</u>
64	Anjali N. Charde	8261964188	anjalicarde20@gmail.com	<u>ACharde</u>
65	Ankita R. Bhoyar	8788031173	ankitabhoyar08@gmail.com	<u>Ankita</u>
66	Idha B. Gupta	9373259849	idha202gupta@gmail.com	<u>Idha</u>



126

DHARAMPETH M. P. DEO MEMORIAL SCIENCE COLLEGE, NAGPUR
INTERNAL QUALITY ASSURANCE CELL (IQAC)
NEP Activity Report

Date : 15/11/22

Name of Organizing Department or Committee: Department of Chemistry

Name of the activity: NEP Activity Sem V Unit II

Suggested CRITERION point if any: Criteria II

Date of Activity: 12/11/22

Place of Activity: Room No. 5

Name of Guest Speaker/s or Judge/s or Chief Guest/s if any: Nil

Title of the Activity: MO diagram of Homo and Heteromolecule

Number of Participants: 66

Name of the Teacher In-charge / Convener: Dr. Sandip Madhukar Bhiwagade

Names of other Committee Members / Staff: Dr. Vaishali P. Meshram

OUTCOME of the Activity with respect to mission vision of the institute and or academics:

In this activity students learn about the postulates of MOT, how molecular orbitals are formed, how molecular orbitals are classified in bonding, antibonding orbital and nonbonding orbitals.

Activity with newspaper coverage if any : Nil

Activity data save in PC of: Department of Chemistry



Dr. Sandip M. Bhiwagade
Sandip Bhiwagade

Name & Signature of Teacher In-charge

Prof. Pitambar Humane

IQAC Coordinator
CO ORDINATOR

INTERNAL QUALITY ASSURANCE CELL
DHARAMPETH, M. P. DEO MEMORIAL &
SCIENCE COLLEGE, NAGPUR

Dr. Akhilesh Peshwe

Principal
PRINCIPAL

Dharampeth M.P. Deo Memorial
Science College, Nagpur-440033



DHARAMPETH M. P. DEO MEMORIAL SCIENCE COLLEGE,
North Ambazari Road, Near Ambazari Lake, Nagpur- 440033

Date: 12/11/22

MO Dig. of Homo & Hetero
molecules & Preparation of ballbon
model

DATA VALIDATION & VERIFICATION (DVV)

NEP Report Submission

Sr.	Name of student	Mobile No	Email	Sign.
1.	Priyanshi Singh	7219259020	priyanshisingh18040@gmail.com	P Singh
2.	Anushka D. Das	7058933157	ado4092001@gmail.com	Das
3.	Nikita G. Ekre	7972190515	ekrenikita3uu@gmail.com	Ekre
4.	Shruti A. Kukole	9075232517	Shrutikukole13@gmail.com	S. Kukole
5.	Chaitali M. Burebade	9359540394	chaitali20206@gmail.com	Chaitali
6.	Tanmay Bhute	7697250531	tanmaybhute90@gmail.com	Tanmay
7.	Akanksha R. Yelure	9730108278	akankshayelure@gmail.com	Akanksha
8.	Pragya R. Jha	9665852975	pragya9297@gmail.com	Jha
9.	Shivam S. Mawanya	9607873702	Shivamawanya@gmail.com	Shivam
10.	Vishal Kumar Singh	9610187223	singhvishal96@gmail.com	Vishal
11.	Raksha D. Dhote	7498511875	rekshadhote9@gmail.com	R. Dhote
12.	Sakshi Moon	7745827736	sakshim3030@gmail.com	Sakshi
13.	Muskan H. Sheikh	8055474633	Muskan2019555@gmail.com	M. Sheikh
14.	Shivani G. Bhute	9302900209	bhuteshivani85@gmail.com	Shivani

Signature of:

Programme In-charge

COORDINATOR

INTERNAL QUALITY ASSURANCE CELL
DHARAMPETH, M. P. DEO MEMORIAL &
SCIENCE COLLEGE, NAGPUR

Principal

PRINCIPAL

Dharampeth M. P. Deo Memorial
Science College, Nagpur-440033

15.	Pallavi Y. Bhagat	9022654940	Pallavim 2708@gmail.com	Bhagat
16.	Nikita Shebe	9021019101	nikita.shebe2019@gmail.com	Nikita
15.	Arpita Gaydhare	9527250282	arpitagaydhare@gmail.com	Arpita
16.	Akash Ashok Sikolau	8175422051	Sikolau akash 15@gmail.com	Akash
17	Kavishma S. Bamzod	7369812507	Kavishmabamzod401@gmail.com	Kavishma
18.	Raji. N. Tathar	8669595198	Rajiknana66024@gmail.com	R. Tathar
19.	Rani. d. Patel	8669595198	Ranipatel12404@gmail.com	Rani
20.	Pranjali N. Gaikwad	9130893362	gaikwadpranjali39@gmail.com	Gaikwad
21.	Ishwari U. Suryawanshi	8087317297	suryawanshiishwari123@gmail.com	
22.	Aarju S. Patle	7887934824	aarjupatle2002@gmail.com	Aarju
23	Shreuti M. Pawar	9527981707	shreuti Pawar 0001@gmail.com	Shreuti
24.	Diya T. Bondre	8668454925	diyabondre3@gmail.com	Diya
25.	Damini M. Bandbuche	8275105785	bandbuchedamini@gmail.com	D. Bandbuche
26	Aachal Swagh	9579643389	aachalswagh003@gmail.com	Aachal
27.	Shardabini Bhagat	7558367348	shardabhagat452@gmail.com	Shardabini
28.	Pranjali L. Dandekar	9325973318	dandekarpranjali0@gmail.com	P. Dandekar
29	Avanti. A. Chaphekar	7875173847	avanti1011@gmail.com	Avanti



DHARAMPETH M. P. DEO MEMORIAL SCIENCE COLLEGE,
North Ambazari Road, Near Ambazari Lake, Nagpur- 440033

DATA VALIDATION & VERIFICATION (DVV)

30	Aarati Bisen	8167484914	madhusabhanur@gmail.com	Madhusabhanur
31	Adesh K. Hatwan	7517431162	adeshatw022002@gmail.com	A.K. Hatwan
32	Sachin Ghodeshwar	7507999271	sachinghodeshwar@gmail.com	Sachin
33	Nikita R. Rahangdale	9307723308	nikitarahangdale2005@gmail.com	Nikita
34	Neha J. Chandrade	9370570893	nehachandrade246@gmail.com	N. Chandrade
35	Karthik Adlakha	8530597159	kadlakha@gmail.com	Karthik
36	Rammay Chaudhari	8600102341	rchaudhari8600@gmail.com	Rammay
37	Astha Sakhaswade	9405197842	asthasakhaswade@gmail.com	Astha
38	Manish Gade	9370329857	manishgade79@gmail.com	Manish
39	Krushnali S. Kadam	8625854995	krushnali.kadam67@gmail.com	Krushnali
40	Ishika S. Thakre	8010907069	ishithakre22@gmail.com	Ishika
41	Aditi Dhoble	8847709571	aditidhoble5@gmail.com	Aditi
42	Tanushree Dote	9766927406	tanushreedote22@gmail.com	Tanushree
43	Saurabh K. Shukla	7721802706	Shusaurabh77@gmail.com	Saurabh
44	Poochi S. Waghale	8767914118	Poochiwaghale11@gmail.com	Poochi
45	Shubham J. Gupta	7038609520	shubhangupta79@gmail.com	Shubham
46	Harsh S. Singh	9011689573	harshsingh7@gmail.com	Harsh

Signature of:

Programme In-charge

CO ORDINATOR

INTERNAL QUALITY ASSURANCE CELL
DHARAMPETH, M. P. DEO MEMORIAL &
SCIENCE COLLEGE, NAGPUR

Principal
PRINCIPAL

Dharampeth M. P. Deo Memorial
Science College, Nagpur-440033

47	Suraj B. Shende	935666487	surajbshende2018@gmail.com	<u>Suraj</u>
118	Kshiti J. Ahanpaliwar	9834397158	shvam822@gmail.com	<u>Kshiti</u>
49	Vinay R. Jaiswal	8788422102	Vinay R. Jaiswal 8788422101@gmail.com	<u>Vinay</u>
50	Amit J. Walde	9168496253	Amitwalde440@gmail.com	<u>Amit</u>
51	Nitin L. Hasinkhede	9561179324	hasinkhede.vijay@gmail.com	<u>Nitin</u>
52	Neha. A. Waghade	7249895144	nehawaghade16082002@gmail.com	<u>NWaghade.</u>
53	Rani B. Khatke	9011247038	bkrani8112@gmail.com	<u>Rani</u>
54	Rakhi. P. Gedum	7378312504	gedumrakhi2000@gmail.com	<u>Rakhi</u>
55	Mrunali R. Sonare	9850163812	Sonaremrinali16@gmail.com	<u>MRunali</u>
56	Priyanka D. Bohane	7620740373	Priyankabohane9@gmail.com	<u>Priyanka</u>
57	Vaishnavi R. Chandekar	7249882964	vaishnavichandekar@gmail.com	<u>Vaishnavi</u>
58	Aishwarya Joshi		aishwaryajoshi@gmail.com	<u>Aishwarya</u>
59	Vedika P. Karandekar	9145149787	vedikakarandekar@gmail.com	<u>Vedika</u>
60	Anshuman Sharma	8870992462	Anshuman Sharma@gmail.com	<u>Anshuman</u>
61	Chetan Kauthe	9637271601	kauthechetan6@gmail.com	<u>Chetan</u>
62	Supriya Patte	7757971925	supriyapatte@gmail.com	<u>Supriya</u>
63	Megha Fulwar	8605399606	meghafulwar@gmail.com	<u>Megha</u>
64	Anjali N. Charde	8261964188	anjalicarde20@gmail.com	<u>Anjali</u>
65	Ankita R. Bhoyar	8788031173	ankitabhoyar06@gmail.com	<u>Ankita</u>
66	Idha B. Gupta	9373259849	idha2002gupta@gmail.com	<u>Idha</u>



DHARAMPETH M. P. DEO MEMORIAL SCIENCE COLLEGE, NAGPUR
DEPARTMENT OF COMPUTER SCIENCE
ACADEMIC SESSION: 2022-23

NOTICE

10th November 2022

All the students are hereby informed that the Department of Computer Science, Dharampeth M.P. Deo Memorial Science College, Nagpur and Department of Robotics and Cloud Technology, RTMNU, Nagpur Organizes an interesting and value-added Seminar on "Cloud Technology & Information Security and It's Future Opportunities" on 14th November 2022. All the interested students should register themselves on or before 12th November 2022. The details are given below;

 **Registration Link :**

<https://bit.ly/3GgGBXc>

Date : Monday, November 14, 2022

Time: *12:00 PM TO 1:00 PM (IST)*

Resource Person -

Mr. Anil Tatode

Training Officer

Department Of Robotics & Cloud Technology, RTMNU, Nagpur

Seminar Highlights

Know how of Industry Insights

Introduction to Cloud Technology

User Segments

Revenue Forecast - India

Revenue Forecast - Global

Job Profile in Cloud Technology

Employment Opportunities in India

Global Employment Opportunities



Head, Department of Computer Science

Head,
Department of Computer Science
Dharampeth M. P. Deo
Science College, Nagpur



DHARAMPETH M. P. DEO MEMORIAL SCIENCE COLLEGE, NAGPUR
DEPARTMENT OF COMPUTER SCIENCE
ACADEMIC SESSION: 2022-23

NOTICE

10th November 2022

All the students are hereby informed that the Department of Computer Science, Dharampeth M.P.Deo Memorial Science College, Nagpur and Department of Robotics and Cloud Technology, RTMNU, Nagpur Organizes an interesting and value-added Seminar on "Cloud Technology & Information Security and It's Future Opportunities" on 14th November 2022. All the interested students should register themselves on or before 12th November 2022. The details are given below:



Registration Link :

<https://bit.ly/3GgGBXc>

Date : Monday, November 14, 2022

Time* : *12:00 PM TO 1:00 PM (IST)

Resource Person -

Mr. Anil Tatode

Training Officer

Department Of Robotics & Cloud Technology, RTMNU, Nagpur

Seminar Highlights

Know how of Industry Insights

Intorduction to Cloud Technology

User Segments

Revenue Forecast - India

Revenue Forecast - Global

Jobs Profile in Cloud Technology

Employment Opportunities in India

Global Employment Opportunities

Head , Department of Computer Science

Head,
Department of Computer Science
Dharampeth M. P. Deo Memorial
Science College, Nagpur.



DHARAMPETH M. P. DEO MEMORIAL SCIENCE COLLEGE, NAGPUR
INTERNAL QUALITY ASSURANCE CELL (IQAC)

Activity Report

Date: 30th November 2022

Name of Organizing Department or Committee: Department of Computer Science in association with Department of Robotics and Cloud Technology, RTMNU

Name of the activity: A Seminar

Suggested CRITERION point if any: Criteria V

Date of Activity: 14th November 2022

Place of Activity: In house (Zoom Platform)

Name of Guest Speaker/s or Judge/s or Chief Guest/s if any: Mr. Anil Tatode, Trainer
Department of Robotics and Cloud Technology, RTMNU

Title of the Activity: "Cloud Technology & Information Security and Its Future Opportunities."

Number of Participants: 118

Name of the Teacher In-charge / Convener: Dr. Snehal Narale

Names of other Committee Members / Staff: Mrs. Ruma Kapre, Mrs. Shraddha Ozarkar

OUTCOME of the Activity with respect to mission vision of the institute and or academics:

This webinar helps the students to understand the basics of cloud computing and the technology along with its merit, demerit and applications. It helps the students to get aware about the technology used in the area. Along with this the webinar would help the students to understand the follows concepts related to cloud and its security in details:

1. Cloud Visibility.
2. The best cloud security solutions like AppTrana enable 24x7 monitoring of the application and cloud-based assets.
3. Higher Availability.
4. Effective protection against DDoS Attacks. ...
5. Data Security. ...
6. Pay as you Go Model. ...
7. Advanced Threat Detection. ...
8. Regulatory Compliance.

The highlights of the seminar were as follows:

- Know how of Industry Insights
- Introduction to Cloud Technology
- User Segments
- Revenue Forecast - India
- Revenue Forecast - Global
- Jobs Profile in Cloud Technology
- Employment Opportunities in India
- Global Employment Opportunities

Activity with newspaper coverage if any: Nil

Activity data save in PC of: Dr. Mrs. Snehal Narale's Laptop

Registration Form Response Link :

<https://bit.ly/3GgGBXc>



Satale
 Dr. Mrs. Snehal Narale
 Name & Signature of Teacher In-charge

Humane

Prof. Pitambar Humane
 IQAC Coordinator
 IQAC Co-ordinator
 Dharampeth M.P. Deo Memorial
 Science College, Nagpur-440033

Peshwe
 Dr. Akhijesh Peshwe
 Principal
 Principal
 Dharampeth M.P. Deo Memorial
 Science College, Nagpur.



DHARAMPETH M. P. DEO MEMORIAL SCIENCE COLLEGE,
North Ambazari Road, Near Ambazari Lake, Nagpur-440033

DATA VALIDATION & VERIFICATION (DVV)

Name of the Programme : Seminar on cloud Technology (Information security & ITS future opportunities)
Date of the Programme : 14/11/2022
Name of Chief Guest if any :
Name of Guest Speaker if any : Mr. Anil Tatode, Training officer, Dept. of Robotics & cloud, PTMM

Sr. No.	Name of the Participant	Mobile Number	E-mail Id	Signature
1.	Isha Nemade	7028494761	ishanemade@gmail.com	Ishane
2.	Bhagyashree S. Thakare	8766925275	thakarebhagyashree@gmail.com	Bhatakare
3.	Nidhan Surjuse	9805570279	nidhanurjuse2@gmail.com	Nidhan
4.	Sarehita Patil	9218049071	sarehita.patil2002@gmail.com	Sarehita
5.	Damini Katta	8208255685	daminikatta31@gmail.com	Damini
6.	Shweta Bedwal	8080440484	shwetabedwal2605@gmail.com	Shweta
7.	Khushboo Ganesh Walimik	8983700782	khushboowalimik14@gmail.com	Khushboo
8.	Yamini Mishra	8623046668	yaminimishra2257@gmail.com	Yamini
9.	Komal Kumbhare	7620314869	kumbhare.komal99@gmail.com	Komal
10.	Neha J. Bunker	8055477553	nehajbunker@gmail.com	Neha

Signature of
Ratode
Programme In-charge

Head,
Department of Computer Science
Dharampeth M. P. Deo Memorial
Science College, Nagpur

Signature of
Anil
IQAC Coordinator

CO ORDINATOR
INTERNAL QUALITY ASSURANCE CELL
DHARAMPETH, M. P. DEO MEMORIAL &
SCIENCE COLLEGE, NAGPUR

Signature of
Debnar
Principal

Principal
Dharampeth M.P. Deo Memorial
Science College, Nagpur.



DHARAMPETH M. P. DEO MEMORIAL SCIENCE COLLEGE,
North Ambazari Road, Near Ambazari Lake, Nagpur-440033

DATA VALIDATION & VERIFICATION (DVV)

11.	Taru Sonjay Mahude	7057844382	tarusmahude@gmail.com	Tarude
12.	Dikshita Anamol Sakhar	9028830801	dikshitaanamol@gmail.com	Dikshita
13.	Kaushli Anil Gupta	9992997935	kg99930@gmail.com	Gupta
14.	Soni Chetan Rai	885598508	Sonichetanrai@gmail.com	Soni
15.	Sajasa Phomaj Sonwane	902155140	sajasa1010@gmail.com	Sajasa
16.	Sesma Madan Lakda	7058728070	sesmalakda073@gmail.com	Lakda
17.	Somiksha R. Khasare	9604473539	somikshakhasare@gmail.com	Khasare
18.	Sakshi Satish Hiwarkar	9356651344	sakshihiwarkar@gmail.com	Sakshi
19.	Sonija V. Chonija	9764386844	DVC.Chonija@gmail.com	Chonija
20.	Utkarsha A. Tale	7439159178	utkarshatale9@gmail.com	Tale
21.	Chetna S. Bhusile	8010342968	bhusilechetna@gmail.com	Chetna
22.	Tata T. Waghmare	8855919474	tatawaghmare9474@gmail.com	Tata
23.	Timu H. Singh	8806855808	timusingh69499@gmail.com	Singh
24.	Pranali V. Gupta	7020069377	kg991539@gmail.com	Gupta
25.	Pradnya B. Trapude	8010362282	Pradnyatrapude945@gmail.com	Trapude
26.	Syanti Kulkarni	8767911307	syantikulkarni@gmail.com	Kulkarni

Signature of:

Kasali
Programme In-charge

Head,

Department of Computer Science
Dharampeth M. P. Deo Memorial
Science College, Nagpur

IQAC Coordinator

CO ORDINATOR
INTERNAL QUALITY ASSURANCE CELL
DHARAMPETH, M. P. DEO MEMORIAL &
SCIENCE COLLEGE, NAGPUR

Principal

Dharampeth M.P. Deo Memorial
Science College, Nagpur.



CHARANPETH M. P. DEO MEMORIAL SCIENCE COLLEGE,
North Ambazari Road, Near Ambazari Lake, Nagpur - 440033

DATA VALIDATION & VERIFICATION (DVV)

27.	Pranjal D. Sankulkarni	7385458570	pranjal.sankulkarni@gmail.com	Pranjal
28.	Diya R. Patil	7457052463	diyapattil65@gmail.com	Patil
29.	Simran N. Ahimale	7666330683	simranahimale80@gmail.com	Ahimale
30.	Prachi G. Pawar	77263935912	prachipawar282@gmail.com	P.G. Pawar
31.	Shilpa N. Deshpande	8130091540	shilpadeshpande2109@gmail.com	Shilpa
32.	Kashish K. Bisera	7887886117	kashishbisera05@gmail.com	K. Bisera
33.	Sania Niwal	7058425021	niwalsonia970@gmail.com	Sania
34.	Nisha S. Katarake	9890996646	nishakatarake23@gmail.com	Nisha
35.	Pooja Debnikar	8767581278	pedebnikar@gmail.com	Debnikar
36.	Vaidheer B. Chougale	8507807278	gorylev.vaidheer@gmail.com	Chougale
37.	Devshree Kulkarni	8021344265	kulkarnidevshree@gmail.com	D.P. Kulkarni
38.	Monal N. Shenkar	7796516257	shenkarmonal92@gmail.com	Monal
39.	Samiksha B. Shenkar	7420881158	samikshashenkar20@gmail.com	Samiksha
40.	Vaidika P. Nargalkar	9325962446	nargalkarvaidika@gmail.com	Vaidika
41.	Pratishtha J. Bore	9579226218	pratishthabore1998@gmail.com	Pratishtha Bore
42.	Muskan C. Vaidya	9209718287	muskanvaidya9@gmail.com	Vaidya

Signature of

Programme In-charge

Head,

Department of Computer Science
Charanpeth M. P. Deo Memorial
Science College, Nagpur

IQAC Coordinator

CO-ORDINATOR

NATIONAL QUALITY ASSURANCE CELL
CHARANPETH M. P. DEO MEMORIAL
SCIENCE COLLEGE, NAGPUR

Principal

Principal
Charanpeth M.P. Deo Memorial
Science College, Nagpur



DHARAMPETH M. P. DEO MEMORIAL SCIENCE COLLEGE,
North Ambazari Road, Near Ambazari Lake, Nagpur-440033

DATA VALIDATION & VERIFICATION (DVV)

43	Nilmit V. Sable	9322410388	nilmitsable2508@gmail.com	
44	Ankursh (Mawale)	7582194156	agawade08@gmail.com	
45	Ved S. Chaudhary	7498572766	vedchaudhary02@gmail.com	
46	Tushar R. Achare	9075995617	tusharshyl5@gmail.com	
47	Anamika K. Khar	9028833552	khar123@gmail.com	
48	Vedant D. Unethkar	9049932753	unethkarvedant@gmail.com	
49	Tejas Dongre	9322578918	Tejasdongre053@gmail.com	
50	BADAL G. SOMKUNWAR	7448247750	badalsonkumar16@gmail.com	
51	Pratik D. Ingle	7057937510	Pratikingle@gmail.com	
52	Bhavesh R. Maske	7489951631	bhaveshmaske2002@gmail.com	
53	Tanmay S. Gaudam	7262034396	tanmaygadam36@gmail.com	
54	Rajit L. Rohad	9175635273	Rajitrohadv@gmail.com	
55	Mukund S. Hood	9604785822	mukundhood2002@gmail.com	
56	Sahil Singh	7257767502	sahilsingh01@gmail.com	
57	Purushottam Khar	7020698091	purushottamkhar@gmail.com	
58	Vivek V. Kulkarni	9373167516	kulkarnivivek389@gmail.com	

Signature of

Pratik D. Ingle
Programme In-charge

IGAC Coordinator

Principal

Head,
Department of Distance Education
Dharampeth M. P. Deo Memorial
Science College, Nagpur

CO ORDINATOR
INTERNAL QUALITY ASSURANCE CELL
DHARAMPETH, M. P. DEO MEMORIAL
SCIENCE COLLEGE, NAGPUR

Dharampeth M. P. Deo Memorial
Science College, Nagpur.



DHARAMPETH M. P. DEO MEMORIAL SCIENCE COLLEGE,
North Ambarali Road, Near Ambarali Lake, Nagpur-440033

DATA VALIDATION & VERIFICATION (DVV)

59	Sandeep Kumar	8081146948	Sandeepk27900@gmail.com	Sandeep
60	Aditya Kumar Singh	7950543901	adityasingh28120@gmail.com	Aditya
61	Nitin K. Kusumakar	9693429015	nitin.kusumakar206@gmail.com	Nitin
62	Jay Anilbhai Patil	7385436956	Jay.Patil0326@gmail.com	Jay
63	Adityakumar Shukla	9518994636	adityashukla099@gmail.com	Aditya
64	Anuj M. Mishra	8103656208	anujmishra2510@gmail.com	Anuj
65	Harit Kishorekar	9055709357	haritkishorekar@gmail.com	Harit
66	Harit Kishorekar	9767219301	haritkishorekar5@gmail.com	Harit
67	Abdul Basit Anwar Saifiqur	766928578	abulbasit2511@gmail.com	Abdul
68	Vishal Girihal	9673681972	Vishalgirihal27@gmail.com	Vishal
69	Tejas P Pawar	9422489061	Tejas.P.Pawar@gmail.com	Tejas
70	Pratishtha P. Deshpande	8388133260	pratishthadeshpande@gmail.com	Pratishtha
71	Bhavesh D. Mathur	9021317056	bhaveshmathur181120@gmail.com	Bhavesh
72	Sourabh V. Raut	9527023213	Sourabh.Raut1205@gmail.com	Sourabh
73	Yash R. Khedekar	7020929422	yash.khedekar5@gmail.com	Yash
74	Santosh S. Jitkhan	8605710878	santoshjitkhan@gmail.com	Santosh

Signature of
Santosh
Programme in-charge

Head,
Department of Computer Science
Dharampeth M. P. Deo Memorial
Science College, Nagpur

Ant.
IQAC Coordinator

CO ORDINATOR
INTERNAL QUALITY ASSURANCE CELL
DHARAMPETH, M. P. DEO MEMORIAL
SCIENCE COLLEGE, NAGPUR

Ant.
Principal

PRINCIPAL
Dharampeth M. P. Deo Memorial
Science College, Nagpur



DHARAMPETH M. P. DEO MEMORIAL SCIENCE COLLEGE,
North Ambazari Road, Near Ambazari Lake, Nagpur- 440033

DATA VALIDATION & VERIFICATION (DVV)

75)	Vibhanshu Lavasa Jain	9581232204	Vibhanshu.jain7@gmail.com	Vibhanshu
76)	Prayanshu Prady Singh	9527710380	Prayanshu.singh1234@gmail.com	P Singh
77)	Aradhita Ravidas Chhalak	9021640582	pradikhabhaskar@gmail.com	Aradhita
78)	Rohit S. Pandey	8767788709	889756531@gmail.com	R Pandey
79)	Mansi P. Pat	7350450539	mansipat@gmail.com	Mansi
80)	Sanjit Joshi	8975706798	sanjit.joshi@gmail.com	Sanjit
81)	Pranav S. Dore	8830624245	pranavdore47@gmail.com	Pranav
82)	Prathmesh S. Badhye	9765222138	prathmeshbadhye@gmail.com	Prathmesh
83)	Pratham M. Jorjar	901144930	pratham.jorjar43@gmail.com	Pratham
84)	Nikhil K. Jankar	9026121407	Nikhiljankar@gmail.com	Nikhil
85)	Nirish Q. Nawghane	9099879785	nawghane@gmail.com	Nirish
86)	Sandeep L. Gurde	9067118437	sandeepgurde15@gmail.com	Sandeep
87)	Ashish Rane	9022226215	ashishrane123@gmail.com	Ashish
88)	Aditya Singh	8999323047	aditya8999singh@gmail.com	Aditya
89)	Gendal Makhade	9112142728	gendalmakhade@gmail.com	Gendal
90)	Samiksha A. Panchbudhe	9763075490	samikshapanchbudhe@gmail.com	Samiksha

Signature of

Rasale

Programme in-charge
Head,

Department of Computer Science
Dharampeth M. P. Deo Memorial
Science College, Nagpur

IQAC Coordinator

CO ORDINATOR
INTERNAL QUALITY ASSURANCE CELL
DHARAMPETH, M. P. DEO MEMORIAL &
SCIENCE COLLEGE, NAGPUR

Principal

Dharampeth M. P. Deo Memorial
Science College, Nagpur



DHARAMPETH M. P. DEO MEMORIAL SCIENCE COLLEGE,
North Ambazari Road, Near Ambazari Lake, Nagpur- 440033

DATA VALIDATION & VERIFICATION (DVV)

91)	Urvashi S. Umathe	8177779277	uvmshumathe@gmail.com Umathe
92)	Sakshi V. Kanade	8806934839	sakshikanade326@gmail.com Kanade
93)	Urnati C. Chopde	9022677617	urnatichopde2002@gmail.com Chopde
94)	Mansi D. Nandanwar	7709322027	mansinandanwar1@gmail.com Nandanwar
95)	Vicky A. Singh	9834782931	vickyasingh11032000@gmail.com Vicky
96)	Suman R. Singh	9322018596	sumansingh12045628@gmail.com Suman
97)	Khushi D. Waghade	9156520783	khushi.waghade@gmail.com K.D. Waghade
98)	Vaishnavi D. Jadhav	9156916855	VJ0808597@gmail.com Jadhav
99)	Amkumar D. Desai	9763674388	amkumard12@gmail.com Desai
100)	Priyanka S. Narkar	9498039928	priyankas1234@gmail.com Narkar
101)	Ankur S. Krupali	7249884620	ankurkrupali@gmail.com Ankur
102)	Hibert B. Kulkarni	7058427112	hibertkulkarni30@gmail.com Kulkarni
103)	Akshay P. Khandare	7350956109	akshay.khandare79@gmail.com Aksh
104)	Kunal S. Dighe	8010294303	kunaldighe2007@gmail.com Dighe
105)	Rahul Kausade	9359525716	Raundrahul@gmail.com Kausade

Signature of:

Program In-charge

Head,

Department of Computer Science
(Dharampeth M. P. Deo Memorial
Science College, Nagpur)



IQAC Coordinator

CO ORDINATOR
INTERNAL QUALITY ASSURANCE CELL
DHARAMPETH, M. P. DEO MEMORIAL
SCIENCE COLLEGE, NAGPUR



Principal
Dharampeth M.P. Deo Memorial
Science College, Nagpur.



DHARAMPETH M. P. DEO MEMORIAL SCIENCE COLLEGE,
North Ambazari Road, Near Ambazari Lake, Nagpur-440033

DATA VALIDATION & VERIFICATION (DVV)

106)	Tanvi Jage	7385060871	TanviJage08@gmail.com	Tanvi
107)	Sakshi Mishra	9529889315	smishra39683@gmail.com	Sakshi
108)	Pritam Kothare	8810793204	Pritamkothare55@gmail.com	Pritam
109)	Tejas Chalmewar	9604662119	Tejaschalmewar@gmail.com	Tejas
110)	Tanvi Laibey	846510589	Tanvilaibey@gmail.com	Tanvi
111)	Varsha Tiwari	9373630950	varshatiwari9856@gmail.com	Varsha
112)	Veena Banikar	9322016921	veenabanikar14@gmail.com	Veena
113)	Rutika Yadav	8466285953	yadavrutika930@gmail.com	Rutika
114)	Divyanshi Zagade	3022866318	divyanshizagade@gmail.com	Divyanshi
115)	Jasni Khade	7385066634	Jasnikhade892@gmail.com	Jasni
116)	Sandhya Sahu	9730305235	Sandhyasahu1544@gmail.com	Sandhya
117)	Renuka Londe	7715351401	renukalonde202@gmail.com	Renuka
118)	Arishka Bhand	7870861383	arishkabhand02@gmail.com	Arishka

Signature of:
[Signature]
Programme In-charge
Head,

Department of Computer Science
Dharampeth M. P. Deo Memorial
Science College, Nagpur

[Signature]

IQAC Coordinator

CO ORDINATOR
INTERNAL QUALITY ASSURANCE CELL
DHARAMPETH M. P. DEO MEMORIAL &
SCIENCE COLLEGE, NAGPUR

[Signature]
Principal

Principal
Dharampeth M.P. Deo Memorial
Science College, Nagpur.



DHARAMPETH M. P. DEO MEMORIAL SCIENCE COLLEGE, NAGPUR

INTERNAL QUALITY ASSURANCE CELL (IQAC)

Activity Report

Date: 18/11/2022

Name of Organizing Department or Committee: Department of Mathematics

Name of the activity: NEP based Short note on the work of Mathematician (Cayley / Hamilton) for B.Sc. Semester-I

Suggested CRITERION point if any: Criterion I.

Date of Activity: 14/11/2022

Place of Activity: Class room

Name of Guest Speaker/s or Judge/s or Chief Guest/s if any: NA

Title of the Activity: Short note on the work of Mathematician (Cayley / Hamilton)

Activity with newspaper coverage if any: No

Number of Participants: B.Sc. Semester-I Students (63)

Name of the Teacher In-charge / Convener: Dr. N. P. Gaikwad

Names of other Committee Members / Staff: N.A.

OUTCOME of the Activity with respect to academics:

The great mathematician Arthur Cayley and William Hamilton are known for their work in matrices. This activity provided them to know and understand their work in detail. This activity helped students to understand the concept of matrices.

DVV: Enclosed.

Dr. N. P. Gaikwad
Name & Signature of Teacher In-charge



Prof. Pitambar Humane
IQAC Coordinator

CO ORDINATOR
INTERNAL QUALITY ASSURANCE CELL
DHARAMPETH, M. P. DEO MEMORIAL &
SCIENCE COLLEGE, NAGPUR



Dr. Akhilesh Peshwe
Principal
Principal
Dharampeth M.P. Deo Memorial
Science College, Nagpur.



DHARAMPETH M. P. DEO MEMORIAL SCIENCE COLLEGE,
North Ambazari Road, Near Ambazari Lake, Nagpur- 440033

DATA VALIDATION & VERIFICATION (DVV)

Name of the Programme : NEP based short note on the work of Mathematics for B.Sc. Sem 2

Date of the Programme : 14/11/2022

Name of Chief Guest if any : -

Name of Guest Speaker if any : -

Sr. No.	Name of the Participant	Mobile Number	E-mail Id	Signature
1	Ved. S. Chaudhary	7498572766	vedchaudhary.cs.749@gmail.com	
2	Mohit Klirdekar	8055328357	mohitklirdekar@gmail.com	
3)	uday c. Baghele	2459549609	baghelecuday@gmail.com	
4)	Tushal Achare	9075995617	achare.tushal5@gmail.com	
5)	Pranali Gupta	9020069377	29991537@gmail.com	
6)	Sandeep Kumar	8081144948	sandeepk2790@gmail.com	
7)	Yadnyak Bhage	8623062678	ysbhage0106@gmail.com	
8)	Gendral Bhojraj Machade	9112142728	nithilmachade2005@gmail.com	
9)	Poojan Gurwant Thakre	8262963719	thakrepoojan739@gmail.com	
10)	TANU . H. SINGH	8806355808	tanusingh63492@gmail.com	
11)	Simran N. Dhimale	7666330683	simrandhimale80@gmail.com	
12)	Vedant S. Umethkar	9069932753	umethkar.vedant@gmail.com	

Programme In-charge

IQAC Coordinator

IQAC Co-ordinator

Dharampeth M. P. Deo Memorial
Science College, Nagpur-440033

Principal

Principal

Dharampeth M. P. Deo Memorial
Science College, Nagpur.



DHARAMPETH M. P. DEO MEMORIAL SCIENCE COLLEGE,
North Ambazari Road, Near Ambazari Lake, Nagpur-440033

DATA VALIDATION & VERIFICATION (DVV)

13	Aniket Jaysam Bawkas	9767219301	AnikeBawka0156@gmail.com	Bawka
14	Sonia Sanjay Niwal	7058425021	niwalsonia70@gmail.com	Niwal
15	Nisha Shriam Kowarkar	9890996645	nishakowarkar333@gmail.com	Kowarkar
16	Kashish K. Bisen	7887886117	kashishbisen@gmail.com	K. Bisen
17	Monali N. Shende	7796516257	shendemonali92@gmail.com	Monali
18	Pranali R. Dehankar	8767581278	Pdehna@gmail.com	Pranali R.D.
19	Bhagyashree D. Nalote	7796434177	sakshineware2017@gmail.com	B. Nalote
	Aditya S. Gosavi	9158048313	aditya.gosavi71@gmail.com	A. Gosavi
	Priyanshu Singh	9527710380	PriyanshuSinghji001@gmail.com	P. Singh
	Pratik Niranwar	9324788243	PratikNiranwar@gmail.com	Pratik
	Ritik Niranwar	9948066424	RitikNiranwar@gmail.com	Niranwar
	Vibhanshu Jain	9561232204	vibhanshujain7@gmail.com	Vibhanshu
	Khushi Pali	8367680724	PaliKhushi4@gmail.com	Khushi
	Khushbu Pali	8959565214	paliKhushbu@gmail.com	Khushbu
	Jannu Varkhi	9322044903	jannuvarkhi@gmail.com	Jannu
	Harshata Warkhede	8263977208	harshatawarkhede@gmail.com	Harshata
	Badal Gendal Somkuwar	7448247750	badalSomkuwar1@gmail.com	Badal
	Mahesh D. Pawde	9112875119	pawdemahesh97@gmail.com	Mahesh

Programme In-charge

IQAC Coordinator

IQAC Co-ordinator

Dharampeth M.P. Deo Memorial
Science College, Nagpur-440033

Principal

Principal

Dharampeth M.P. Deo Memorial
Science College, Nagpur.



DHARAMPETH M. P. DEO MEMORIAL SCIENCE COLLEGE,
North Ambazari Road, Near Ambazari Lake, Nagpur-440033

DATA VALIDATION & VERIFICATION (DVV)

Nayan N. Walhase	784182447	nayanwalhase10@gmail.com	NWalhase
Isha T. Waghmare	8855919474	ishawaghmare2474@gmail.com	Isha
Yogita J. Karamore	8381045307	swara.karamore@gmail.com	YKaramore
Bhagyashali D. Deware	7796434177	sakshineware2019@gmail.com	B.D. Deware
Chetna S. Buiwle	8010342968	buiwlechetna@gmail.com	Chetna
Devashri P. Kakde	9021844265	kakdedevashri@gmail.com	D.P. Kakde
Shrutika G. Pise	9322316336	shrutikapise67@gmail.com	S.Pise
Divyani G. Zade	7972403069	divyanizade2005@gmail.com	D.Zade
Janhvi Kismarou	7058235243	janhvikismarou@gmail.com	J.Kismarou
Ashwini R. Chaudhary	9689699792732	chaudharyashwini@gmail.com	A.R. Chaudhary
Shreya G. Bhimte	9637762811	shreyabhimte1@gmail.com	Shreya
Tejas Dongre	9322578518	tejasdongre453@gmail.com	T.Dongre
Janvi Joge	7385660891	Janvijoge08@gmail.com	Janvi
Veena Borikar	9822016921	veena_borikar_14@gmail.com	Veena
Samirna Shende	7420881158	samirna_shende@gmail.com	S.Shende
Vaidhee B. Gangol	7507907278	gangolvaidhee@gmail.com	V.Gangol
Tejas R. Chetmelkar	964662119	tejaschetmelkar@gmail.com	T.Chetmelkar

Signature of:

Programme In-charge

IQAC Coordinator
Dharampeth M. P. Deo Memorial
Science College, Nagpur-440033

Principal
Dharampeth M.P. Deo Memorial
Science College, Nagpur.



DHARAMPETH M. P. DEO MEMORIAL SCIENCE COLLEGE,
North Ambazari Road, Near Ambazari Lake, Nagpur-440033

DATA VALIDATION & VERIFICATION (DVV)

Vaishali M. Sahasre	4972925403	khineshwar vaishali.sahasre251@gmail.com	Vaishali
Khineshwar R. Pushptode	8624976072	khineshwaripushptode@gmail.com	Sh
Utkarsha Ingale	7499159178	utkarshaingale9@gmail.com	Utkarsha
Ankit Patel	9970905638	ankitpatel797275@gmail.com	Ankit
Jenivi Kimpalare	7058235243	jenivikimpalare@gmail.com	Jenivi Kimpalare
Samiksha. panchbudhe	9763075890	samikshapanchbudhe3@gmail.com	S. Panchbudhe
Divyani V. Zagade	9022866318	divyanizagade@gmail.com	Divyani
Jenivi V. Khade	4385066634	Jenivikhade@gmail.com	Jenivi
Abhishek R. Singh	8208948107	Abhi088205@gmail.com	Abhishek
Vaideli Nagalkar	9325463446	Vaidelinagalkar@gmail.com	Vaideli
Monu P. Patil	7350450579	monupat@gmail.com	Monu
Janvi Laibey	8466510539	Janvilalibey@gmail.com	Janvi
Sakshi Mishra	9529889315	smishra9968@gmail.com	Sakshi
Varsha Turkar	9373650950	varshaturkar488@gmail.com	Varsha
Ruchi Dwivedi	8080776893	ruchidwivedi2306@gmail.com	Ruchi

Signature of:

Programme In-charge

IQAC Coordinator

Dharampeth M. P. Deo Memorial
Science College, Nagpur-440033

Principal

Dharampeth M. P. Deo Memorial
Science College, Nagpur.



DHARAMPETH M. P. DEO MEMORIAL SCIENCE COLLEGE, NAGPUR

INTERNAL QUALITY ASSURANCE CELL (IQAC)

Activity Report

Date: 17/11/2022

Name of Organizing Department or Committee: Department of Mathematics

Name of the activity: NEP based worksheet on Derivatives, for B.Sc. Semester-I

Suggested CRITERION point if any: Criterion I.

Date of Activity: 14/11/2022

Place of Activity: Class room

Name of Guest Speaker/s or Judge/s or Chief Guest/s if any: NA

Title of the Activity: Worksheet on Derivatives

Activity with newspaper coverage if any: No

Number of Participants: B.Sc. Semester-I Students (46)

Name of the Teacher In-charge / Convener: Dr. N. P. Gaikwad

Names of other Committee Members / Staff: N.A.

OUTCOME of the Activity with respect to academics:

In mathematics, the derivative of a function of a real variable measures the sensitivity to change of the function value with respect to a change in its argument. Derivatives are a fundamental tool of calculus. This activity helped students to understand the concept of derivative.

DVV: Enclosed.

(Dr. N. P. Gaikwad)
Name & Signature of Teacher In-charge



Prof. Pitambar Humane

IQAC Coordinator

CO ORDINATOR
INTERNAL QUALITY ASSURANCE CELL
DHARAMPETH, M. P. DEO MEMORIAL &
SCIENCE COLLEGE, NAGPUR



Dr. Akhifesh Peshwe

Principal

Principal
Dharampeth M.P. Deo Memorial
Science College, Nagpur.



DHARAMPETH M. P. DEO MEMORIAL SCIENCE COLLEGE,
North Ambazari Road, Near Ambazari Lake, Nagpur- 440033

DATA VALIDATION & VERIFICATION (DVV)

Name of the Programme : NRP based workshop on Derivatives for B.Sc. sem I
 Date of the Programme : 14/11/2022
 Name of Chief Guest if any : —
 Name of Guest Speaker if any : —

Sr. No.	Name of the Participant	Mobile Number	E-mail Id	Signature
1]	Tushal Achare	9075995617	achare.tushals@gmail.com	<i>Tushal</i>
2]	Simran N. Dhimale	7666330683	simrandhimale80@gmail.com	<i>Dhimale</i>
	Uday C. Baghete	8459549609	bagheteuday@gmail.com	<i>Uday</i>
	Vedant S. Unkethar	9049932753	unketharvedant@gmail.com	<i>Ved</i>
	Mahesh D. Pawade	9112875119	pawademahesh97@gmail.com	<i>Mahesh</i>
	Gendral Bhajraj. Meehade	9112142728	nikhilmeehade2005@gmail.com	<i>Gendral</i>
	TANU. H. SINGH	8806355808	tanusingh63492@gmail.com	<i>Tanu</i>
	Ved. S. Chaudhary	7498522766	vedhaudharys-109@gmail.com	<i>Ved</i>
	Mohit Khirdkar	8055328357	mohitkhirdkar@gmail.com	<i>Mohit</i>
	Yadnyak Dhage	8623062678	yadnyak0106@gmail.com	<i>YD</i>
	Pawan G. Thakre	8262969118	thakrepawan799@gmail.com	<i>P. Thakre</i>
	Uday C. Baghete	8459549609	bagheteuday@gmail.com	<i>Uday</i>

Programme In-charge

IQAC Coordinator

Principal

IQAC Co-ordinator

Principal



DHARAMPETH M. P. DEO MEMORIAL SCIENCE COLLEGE,
North Ambazari Road, Near Ambazari Lake, Nagpur-440033

DATA VALIDATION & VERIFICATION (DVV)

Sandeep Kumar	8001144941	sandeepk27900@gmail.com
Pranali Gupta	7020069377	29991537@gmail.com
Dhyaneshu Singh	9527710380	DhyaneshuSingh1002@gmail.com
Pratik Hiranwar	9324788243	PratikHiranwar@gmail.com
Ritik Hiranwar	7498066424	RitikHiranwar@gmail.com
Khuski Pali	8767607224	KushkiPali@gmail.com
Khuski Pali	8459565214	pdikhuski59@gmail.com
Tannu Vasthi	9322044903	TannuVasthi@gmail.com
Harshata Bhakhet	8263977208	harshatabhakhet@gmail.com
Aditya Gosavi	9158948313	aadityagosavi71@gmail.com
Vibhanshu K. Tane	9561232204	VibhanshuTane7@gmail.com
Sonia Niswal	7058425021	niswalsonia70@gmail.com
Vaidhvee B. Gangal	7507907278	gangalvaidhvee@gmail.com
Aniket J. Bawarkar	9767219301	AniketBawarkar@gmail.com
Tejas Dongre	9322578918	TejasDongre452@gmail.com
Vaishali Mahesh Sahasrabudhe	7992925403	VaishaliSahasrabudhe251@gmail.com
Khineshwar R. Pushptode	8624976072	khineshwarpushptode@gmail.com
Tanvi. M. Joge	7315060871	TanviJoge08@gmail.com
Shreya G. Shimte	9637762811	Shreyashimte11@gmail.com

Programme in-charge

IQAC Coordinator

Principal

IQAC Co-ordinator

Dharampeth M. P. Deo Memorial
Science College, Nagpur-440033

Principal

Dharampeth M. P. Deo Memorial
Science College, Nagpur.



DHARAMPETH M. P. DEO MEMORIAL SCIENCE COLLEGE,
North Ambazari Road, Near Ambazari Lake, Nagpur- 440033

DATA VALIDATION & VERIFICATION (DVV)

Veena Borikar	9322016921	veenakorikar14@gmail.com	<u>Veena</u>
Shrutika G. Pise	9322316336	shrutikapise67@gmail.com	<u>Spise</u>
Kashish K. Bisen	9887886119	KashishBisen08@gmail.com	<u>K-Bisen</u>
Nitya Shrivastava Kharak	9890996645	nityakharak333@gmail.com	<u>Nitya</u>
Pranali R. Dehankar	8767581278	pdehna@gmail.com	<u>Pranali R</u>
Divyani G. Zade	7972403069	divyanzade2005@gmail.com	<u>Zade</u>
Samiksha Shende	7420881158	Samikshashende08@gmail.com	<u>Sshende</u>
Ashwini R. Chaudhary	9699792732	chaudharyashwini28@gmail.com	<u>A.R. Chaudhary</u>
Monali N. Shende	7796516257	shendemonali72@gmail.com	<u>Monali</u>
Chetna S. Buike	8010342968	buikechetna@gmail.com	<u>Chetna</u>
Devashi. P. Kakde	9021344265	kakdedevashi@gmail.com	<u>D. P. Kakde</u>
Isha I. Waghmare	8855919474	ishawaghmare9474@gmail.com	<u>Isha</u>
Tejus R. Chelmalwar	9604662119	tejuschelmalwar@gmail.com	<u>Tejus</u>
Neeraj N. Wathkar	7841870700	Neeraj N. wathkar@gmail.com	<u>Neeraj</u>
Badal Gendal Somkuwar	7448247750	badal/somkuwar1@gmail.com	<u>Badal</u>
Yogita J. Kadam	8381045307	swaraj.kadam@gmail.com	<u>Yogita</u>
Ankit Patel	9970905638	ankitpatel797275@gmail.com	<u>Ankit</u>

Signature of:

Programme In-charge

IQAC Co-ordinator
Dharampeth M.P. Deo Memorial
Science College, Nagpur-440033

Principal
Dharampeth M.P. Deo Memorial
Science College, Nagpur.



DHARAMPETH M. P. DEO MEMORIAL SCIENCE COLLEGE, NAGPUR

INTERNAL QUALITY ASSURANCE CELL (IQAC)

Activity Report

Date: 14-11-2022

Name of Organizing Department or Committee: Department of Statistics.

Name of the activity: Construction of stem and leaf chart.

Suggested CRITERION point if any:

Date of Activity: 14 November 2022

Place of Activity: Statistics lab

Name of Guest Speaker/s or Judge/s or Chief Guest/s if any:

Title of the Activity: Construction of stem and leaf chart.

Number of Participants: 23

Name of the Teacher: Durga hingwe

Names of other Committee Members / Staff: N.A.

OUTCOME of the Activity with respect to mission vision of the institute and or academics:

Students learn from this activity is, Stem and leaf plots display the shape and spread of a data distribution. They are similar to histograms but they show digits instead of bars. Usually, a stem and leaf plot is ordered, which simply means that the leaves are arranged in ascending order from left to right.

Activity with newspaper coverage if any: No

Activity data save in PC of: Department of Statistics

Prof. Pitambar Humane
IQAC Coordinator

Name & Signature of Teacher In-charge

Dr. Akhilesh Peshwe
Principal

Principal

**Dharampeth M.P. Deo Memorial
Science College, Nagpur.**

CO ORDINATOR
INTERNAL QUALITY ASSURANCE CELL
DHARAMPETH, M. P. DEO MEMORIAL S
SCIENCE COLLEGE, NAGPUR



DHARAMPETH M. P. DEO MEMORIAL SCIENCE COLLEGE NAGPUR

Department of Statistics

Class: B.Sc. Sem.-1

NEP ACTIVITY

Paper II

Unit III

Name of the Teacher: Durga C. Hingwe

Date: 14-11-2022

Title of Activity: Construction of stem and leaf chart

Sr. No.	Name of Student	Batch	Mobile No.	Email ID	Signature
1	Dinayani V. Zagade	F2	9022206318	dinayanizagade@gmail.com	
2	Jamuni V. Khode	F2	7355066634	JamuniKhode@gmail.com	
3	Pranali P. Debnikar	F2	8767581278	Pdebnika@gmail.com	
4	Nisha S. Kowarkar	F2	9990996645	nishakowarkar333@gmail.com	
5	Utkarsha D. Tugale	F2	7499159178	utkarshatugale9@gmail.com	
6	Vidya Lohi	F2	7020963219	Vidyalohi@gmail.com	
7	Sakshi Mishra	F2	9579889315	Sakshimishra39683@gmail.com	
8	Janhvi Laibey	F2	8446510539	Janhvilaibey@gmail.com	
9	Rutika Yadav	F2	8446085943	yadavarutika33@gmail.com	
10	Mudit Khedkar	F2	9055328357	muditkhedkar@gmail.com	
11	Vena Borikar	F2	9322016921	venaborikar14@gmail.com	
12	Janhvi Joge	F2	738506097	JanhviJoge08@gmail.com	
13	Pranali Aupta	F2	7020060377	pranali1537@gmail.com	
14	Jagruti Fullawar	F2	8767911807	Jagrutifullawar@gmail.com	
15	Soniq Niwal	F2	7058425021	niwasoniq70@gmail.com	
16	Chetna Bawle	F2	8010342968	bawlechetna@gmail.com	
17	Devashi Kakate	F2	9021344265	kakatedevashi@gmail.com	
18	Janhvi A. Kianapure	F2	7058235243	janhvikianapure@gmail.com	
19	Pradnya Tirpude	F2	8010362232	pradnyatirpude9145@gmail.com	
20	Vivek S. Sah	F1	9923763071	Vivek.Sah1893@gmail.com	
21	Nayan N. Walthare	F1	7941870947	Nayanwalthare10@gmail.com	
22	Ishita Deshpande	F2	9130091540	ishitadeshpande21004@gmail.com	
23	Varsha L. Turkar	F2	9373650950	varshaturkar983@gmail.com	

Signature of Teacher.

Teacher Incharge



DHARAMPETH M. P. DEO MEMORIAL SCIENCE COLLEGE, NAGPUR

INTERNAL QUALITY ASSURANCE CELL (IQAC)
Activity Report

Date: 14/11/2022

Name of Organizing Department or Committee: Department of Statistics

Name of the activity: Activity on Solving LPP (Graphical Method)

Suggested CRITERION point if any: Restricted to RTMNU BSc Statistics syllabus.

Date of Activity: 14/11/2022

Place of Activity: Statistics Lab

Name of Guest Speaker/s or Judge/s or Chief Guest/s if any: NA

Title of the Activity: Solving an LPP by graphical method

Activity with newspaper coverage if any: No

Number of Participants: 20

Name of the Teacher: Ms. Kumudini Kadbe

Names of other Committee Members / Staff: N.A.

OUTCOME of the Activity with respect to academics:

Owing to the importance of linear programming models in various industries, many types of algorithms have been developed over the years to solve them. In this activity students learned graphical method of solving LPP. Also they get to know how to formulate an LPP, how to construct a graph and plot the constraint line, how to determine the valid side of each constraint line, how to identify feasible solution and many more.

DVV: Enclosed.

Activity data save in PC of: Lt. Dr. P. W. Ambekar

Prof. Pitambar Humane
IQAC Coordinator

CO ORDINATOR
INTERNAL QUALITY ASSURANCE CELL
DHARAMPETH, M. P. DEO MEMORIAL &
SCIENCE COLLEGE, NAGPUR

Name & Signature of Teacher In-charge

Dr. Akhilesh Peshwe
Principal
Dharampeth M.P. Deo Memorial
Science College, Nagpur.



DHARAMPETH M. P. DEO MEMORIAL SCIENCE COLLEGE NAGPUR

Department of Statistics

Class: B.Sc. Sem.- V

NEP ACTIVITY

Paper: I

Unit: III

Name of the Teacher: Kumudini Kadbe

Date: 14/11/22

Title of Activity: Solving Dm LPP by graphical method

Sr. No.	Name of Student	Batch	Mobile No.	Email ID	Signature
1	Prachi S. Manusmarre	PSM IT-1	9356969609	prachimanusmarre1@gmail.com	<u>Prachi Manusmarre</u>
2	Himanshu R. Lakhe	PSM	7448232419	himanshulakhe001@gmail.com	<u>Himanshu Lakhe</u>
3	Pijush G. Kapse	PSM	9373563027	kapsepijush01@gmail.com	<u>Pijush Kapse</u>
4	Pratiksha S. Thakre	PSM	8459570299	Pratikshathakre1709@gmail.com	<u>Pratiksha Thakre</u>
5	Divyani V. Dhule	PSM	7030731921	divyavidhule2002@gmail.com	<u>Divyani Dhule</u>
6	Uday P. Khandarkar	PSM	9595897196	udaykhandarkar08@gmail.com	<u>Uday Khandarkar</u>
7	Sakshi L. Borapatre	PSM	8317219372	sakshi2002bb@gmail.com	<u>Sakshi Borapatre</u>
8	Vaibhav S. Rane	PSM	7744951383	Vaibhavrane2207@gmail.com	<u>Vaibhav Rane</u>
9	Pratul G. Gokhand	PSM	7620911383	Pratulgokhand1999@gmail.com	<u>Pratul Gokhand</u>
10	Rishikesh P. Dethre	SCOM	878819260	rishikeshdethre2002@gmail.com	<u>Rishikesh Dethre</u>
11	Saurabh V. Raut	SCOM	9527283213	Saurabhraut4725@gmail.com	<u>Saurabh Raut</u>
12	Wihol V. Gokhale	SCOM	9673681471	Wiholgokhale92@gmail.com	<u>Wihol Gokhale</u>
13	Neha J. Bankare	SCOM	80554775	neha2002bankare@gmail.com	<u>Neha Bankare</u>
14	Diya R. Patil	SCOM	7757052463	diyapatil553@gmail.com	<u>Diya Patil</u>
15	Sahil R. Jivtote	SCOM	9375414643	sahiljivtote71@gmail.com	<u>Sahil Jivtote</u>
16	Komal M Kumbhakar	SCOM	7620314869	KumbhakarKomal04@gmail.com	<u>Komal Kumbhakar</u>
17	Sumeet Shalakar	SCOM	9021627752	Sumeetshalakar26@gmail.com	<u>Sumeet Shalakar</u>
18	Tanu S. Mahule	SCOM	7057844982	tanumahule45@gmail.com	<u>Tanu Mahule</u>
19	Jyotung P. Patil	SCOM	9622488044	Jyotungpatil2002@gmail.com	<u>Jyotung Patil</u>
20	Pranjali D. Sarulkar	SCOM	7384458510	pranjali saru1234@gmail.com	<u>Pranjali Sarulkar</u>

Signature of Teacher

Teacher in charge



DHARAMPETH M. P. DEO MEMORIAL SCIENCE COLLEGE, NAGPUR
INTERNAL QUALITY ASSURANCE CELL (IQAC)

NEP Activity Report

Date : 22 /11/ 2022

Name of Organizing Department or Committee: Chemistry

Name of the activity: NEP Activity. (SEM III –PAPER-2-UNIT-3)

Suggested CRITERION point if any: CRITERION -II

Date of Activity: 14 /11/ 2022

Place of Activity - Chemistry Department

Name of Guest Speaker/s or Judge/s or Chief Guest/s if any: NIL

Title of the Activity: Chart and model preparation: types of alcohols
And uses of Phenol in various industry

Number of Participants: 43

Name of the Teacher In-charge / Convener: Dr. Tanishq Chaudhari

Names of other Committee Members / Staff: Dr. V.P. Meshram

OUTCOME of the Activity with respect to mission vision of the institute and or academics:

By making mini models students came to know about various uses of phenols example
military purpose, cosmetics, face wash, switchboard etc.

Activity with newspaper coverage if any: Nil

Activity data save in PC of Department of Chemistry

Note: Kindly share geotag photographs separately along with report on iqacdsc2022@gmail.com



Prof. Pitambar Humane
IQAC Coordinator
COORDINATOR
INTERNAL QUALITY ASSURANCE CELL
DHARAMPETH, M. P. DEO MEMORIAL &
SCIENCE COLLEGE, NAGPUR

Tanishq
Name & Signature of Teacher In-charge
(Dr. Tanishq Chaudhari)

Dr. Akhlesh Peshwe
Principal

PRINCIPAL
Dharampeth M.P. Deo Memorial
Science College, Nagpur-440033



DHARAMPETH M. P. DEO MEMORIAL SCIENCE COLLEGE,
North Ambazari Road, Near Ambazari Lake, Nagpur- 440033

DATA VALIDATION & VERIFICATION (DVV)

Activity - 3

Name of the Programme

Activity - 3 (Sem-III, Paper-2, Unit-III)

Date of the Programme

14th November ; USES OF PHENOL in various Industries

Name of Chief Guest if any

Name of Guest Speaker if any

Sr. No.	Name of the Participant	Mobile Number	E-mail Id	Signature
1	Aditya . G. Dewkar	9088915776	deulkaraditya21@gmail.com	Dewkar
2	Shikha J. Yadav	7263881320	shikhayadav@gmail	S. Yadav
3	Jagruiti A. Rawat	9265818046	jagruitiagrawat58@gmail.com	J. Rawat
4	Vaishali S. Patle	9522600647	Vaishalipatle123@gmail.com	Patle
5	Ashlesha Sangole	9503998469	Ashleshasangole94@gmail.com	Sangole
6	Ankita M. Mishra	8421293176	mishraankita1940@gmail.com	A. Mishra
7	Komal. S. Patle	9881748506	Komalpatle234@gmail.com	K. Patle
8	Shrutika .R. Borkar.	9067950845	shrutikaborkar@gmail.com	S. Borkar
9	shital R. kelzaker	9373328723	shital2020kelzaker@gmail.com	S. Kelzaker
10	Sejal .R. Lakhanpal	9028851568	sejallakhanpal@gmail.com	S. Lakhanpal

Signature of:

Tamshy

Programme In-charge

COORDINATOR

INTERNAL QUALITY ASSURANCE CELL
DHARAMPETH, M. P. DEO MEMORIAL &
SCIENCE COLLEGE, NAGPUR

Principal
PRINCIPAL

Dharampeth M. P. Deo Memorial
Science College, Nagpur-440033

Activity-3



DHARAMPETH M. P. DEO MEMORIAL SCIENCE COLLEGE,
North Ambazari Road, Near Ambazari Lake, Nagpur- 440033

File

DATA VALIDATION & VERIFICATION (DVV)

Name of the Programme : ARTICLE TOGETHER

Date of the Programme : _____

Name of Chief Guest if any : _____

Name of Guest Speaker if any : _____

Sr. No.	Name of the Participant	Mobile Number	E-mail Id	Signature
11.	Ausija S. Hussain	7066411418	hussainnaziyeh@gmail.com	Ahussain
12.	Lucky A Vishwakarma	9579660186	lvishwakarma@gmail.com	Lvishwakarma
13.	Ghanashree U. Dhamane	8459807047	ghanashreedhamane@gmail.com	Ghanashree
14.	Aarti K. Khare	9579745628	aartikhare@gmail.com	Aarti
15.	Ashwini A. Lanjewar	968917254	lanjewarashwini777@gmail.com	Ashwini
16.	Abhay P. Tembhare	8975363145	abhay220102@gmail.com	Abhay
17.	Saloni D. Dongre	9923367488	dongresaloni0@gmail.com	Saloni
18.	Aakansha K. Kharagade	7972228707	aakanshakharagade@gmail.com	Aakansha
19.	Amisha D. Arkar	7666559171	ArkarAmisha300@gmail.com	Amisha
20.	Gunjan J. Bhoyar	7666799586	gunjanbhoyar204@gmail.com	Gunjan

Signature of: Tamilselvan
Programme In-charge

[Signature]
IQAC Coordinator
CO ORDINATOR
INTERNAL QUALITY ASSURANCE CELL
DHARAMPETH M. P. DEO MEMORIAL &
SCIENCE COLLEGE, NAGPUR

[Signature]
Principal
PRINCIPAL
Dharampeth M.P. Deo Memorial
Science College, Nagpur-440033

Activity - 3



DHARAMPETH M. P. DEO MEMORIAL SCIENCE COLLEGE,
North Ambazari Road, Near Ambazari Lake, Nagpur- 440033

DATA VALIDATION & VERIFICATION (DVV)

21.	Kalyani R. Sindham	8246539622	manishakuzunte99@gmail.com	
22.	Ashalesha Khadgi	8830414264	Rupalithedgi@gmail.com	
23.	Tina R. Rahangdale	9991776769	tinarahangdale@gmail.com	
24.	Vaishnavi P. Lakhe	8669594864	chhakuli.lakhe53@gmail.com	
25.	Vaibhavi A. Shinde	808064082	vaibhavisinde97@gmail.com	
26.	Urmila Y. Bondre	9370673867	bondreurmila2000@gmail.com	
27.	Chhakuli G. Wadikar	9325047907	chhakuliwadikar@gmail.com	
28.	Twinkal G. Lakhunde	8149176609	twinkal.lakhunde@gmail.com	
29.	Vaishnavi Nandpuro	9322439316	VaishnaviNandpuro@gmail.com	
30.	Mansi D. Raut	7385114931	mansiraute431@gmail.com	
31.	Prajwal B. Bhojari	8010434634	Prajwalb738@gmail.com	

Signature of:

Programme In-charge

IQAC COORDINATOR
INTERNAL QUALITY ASSURANCE CELL
DHARAMPETH M. P. DEO MEMORIAL S.
SCIENCE COLLEGE, NAGPUR

Principal
PRINCIPAL
Dharampeth M. P. Deo Memorial
Science College, Nagpur-440033

Activity - 3



DHARAMPETH M. P. DEO MEMORIAL SCIENCE COLLEGE,
North Ambazari Road, Near Ambazari Lake, Nagpur - 440033

DATA VALIDATION & VERIFICATION (DVV)

32	Vaishnavi . P. Lakhe	8669994864	chhakuli.lakhe@gmail.com	Chhakuli Lakhe
33	Chhakuli. G. Wadikar	9325047907	chhwadikar@gmail.com	Chhakuli
34	Urmila V. Bondar	9370673867	bondarurmila@gmail.com	Bondar
35	Tina . A. Rahangdale	9921776769	tinarahangdale@gmail.com	Rahangdale
36	Twinkal G. Lokhande	8149176609	twinkalokhande@gmail.com	Lokhande
37	Vaishnavi Nandhure	9322439310	vaishnavinandhure@gmail.com	Nandhure
38	Mansi D. Raut	7395114931	Mansiraut45@gmail.com	Raut
39	Vaishnavi A. Shende	8080640282	vaibhavkshende97@gmail.com	Vaishande
40	Prajwal Bhayare	8010434634	Prajwalb738@gmail.com	Bhayare
41	Biddhanta G. Hirkare	9579092931	hirkarebiddhanta@gmail.com	Hirkare
42	Niket Thakre	9370899087	niketthakre	Thakre
43	Supesh Bhokar	9834184621	supeshbhokar	Bhokar

Signature of:
Tanishk
Programme In-charge

[Signature]
CO ORDINATOR
INTERNAL QUALITY ASSURANCE CELL
DHARAMPETH M. P. DEO MEMORIAL &
SCIENCE COLLEGE, NAGPUR

[Signature]
PRINCIPAL
Dharampeth M. P. Deo Memorial
Science College, Nagpur - 440033



DHARAMPETH M. P. DEO MEMORIAL SCIENCE COLLEGE, NAGPUR
INTERNAL QUALITY ASSURANCE CELL (IQAC)
NEP Activity Report

Date: 22/11/2022

Name of Organizing Department or Committee: Chemistry

Name of the activity: NEP Activity Report (SEM -III, Paper-I Unit-III)

Suggested CRITERION point if any: Criteria II

Date of Activity: 14-11-2022

Place of Activity: Department of Chemistry

Name of Guest Speaker/s or Judge/s or Chief Guest/s if any- Nil

Title of the Activity: Colour poster of Lanthanides and Actinides and their uses

Number of Participants: 30

Name of the Teacher In-charge / Convener: Dr Mrs Yogita Morey (Dahire)

Names of other Committee Members / Staff: Dr. Mrs. V. P. Meshram

OUTCOME of the Activity with respect to mission vision of the institute and or academics:

This is a student's centric activity. These charts visually clear the concept of students about the colours of Lanthanides and Actinides. They show different colours which can be easily visualised



Activity with newspaper coverage if any: Nil

Activity data saved in PC of: Chemistry Department

Note: Kindly share Jio tag photographs separately along with report on iqacds2022@gmail.com

Prof. Pitambar Humane

IQAC Coordinator

CO ORDINATOR
INTERNAL QUALITY ASSURANCE CELL
DHARAMPETH, M. P. DEO MEMORIAL &
SCIENCE COLLEGE, NAGPUR

Name & Signature of Teacher In-charge

Dr. Mrs. Yogita Morey (Dahire)

Dr. Akhilesh Peshwe
Principal

PRINCIPAL

Dharampeth M.P. Deo Memorial
Science College, Nagpur-441022



DHARAMPETH M. P. DEO MEMORIAL SCIENCE COLLEGE,
North Ambazari Road, Near Ambazari Lake, Nagpur- 440033

DATA VALIDATION & VERIFICATION (DVV)

Name of the Programme : NEP Activity (colour poster of lanthanide and actinides and their uses).
Date of the Programme : 14-11-2022 (Sem III, paper I, unit III)
Name of Chief Guest if any : _____
Name of Guest Speaker if any : _____

Sr. No.	Name of the Participant	Mobile Number	E-mail Id	Signature
1)	Vedant Bory	9881057515	vbory@gmail.com	
2)	Mansi Badole	8010305176	mbadole@gmail.com	
3)	Nidhi Misar	9887505156	ndhim@gmail.com	
4)	Sumit Bandebuche	9275829520	Sumit@gmail.com	
5)	Aditya Tiwari	9823195700	aditya@gmail.com	
6)	Vaishali Bedade	9026163222	Vaishalibe@gmail.com	
7)	Jagnish Wankar	8296103040	jagnish@gmail.com	
8)	Sakshi Meshram	9726168092	sakshi@gmail.com	
9)	Harsh Kodape	9620301166	harshkodape@gmail.com	
10)	Vaishali Gadge	9026163222	vaishali@gmail.com	

Signature of:

Do. Mrs. Jyoti Morey (Dahru)
Programme In-charge

IQAC Coordinator
CO ORDINATOR
INTERNAL QUALITY ASSURANCE CELL
DHARAMPETH, M. P. DEO MEMORIAL &
SCIENCE COLLEGE, NAGPUR.

Principal
PRINCIPAL
Dharampeth M. P. Deo Memorial
Science College, Nagpur-440033



DHARAMPETH M. P. DEO MEMORIAL SCIENCE COLLEGE,
North Ambazari Road, Near Ambazari Lake, Nagpur-440033

DATA VALIDATION & VERIFICATION (DVV)

11)	Jasraj Dewital Palival	9370820325	jasrajpalival42@gmail.com	Jasraj
12)	AMAN ANIL DONGRE	7709217312	amandongre2003@gmail.com	Aman
13)	Praywal. S. Bhojari	8010434634	Praywal6738@gmail.com	Praywal
14)	Sania A. Raja	8975726700	midhatania@gmail.com	Sania
15)	Nrupur. M. Sharma	9322042259	nrupursharma258@gmail.com	Nrupur
16)	Jyoti. J. Sharma	8669786380	jyoti's 8390@gmail.com	J. Sharma
17)	Nikita T. Kalle	9067324988	Kallanikita54@gmail.com	Nikita
18)	Bidkhatu G. Hirkane	9578092931	bidkhatu1234@gmail.com	Bidkhatu
19)	Kajjanna D. Suhagpure	9579236712	Kajpanasuhagpure7@gmail.com	Kajjanna
20)	Kajal P. Nijhet	9373250623	Kajunijhet2000@gmail.com	Kajal
21)	Juhi S. Chaudhari	8669248944	chaudharijuhi120@gmail.com	Juhi
22)	Sakshi .S. Meshram	9145855433	sakshimshram21@gmail.com	Sakshi
23)	Urmila V. Bondre	9370673867	bondrevurmila.2000@gmail.com	Urmila
24)	Shreya S. Dhawale	8888264004	shreyadhawale.124@gmail.com	Shreya
25)	Vaibhavi Shende	8080640282	vaibhavishende39@gmail.com	V. A. Shende
26)	Tina Rahangdale	9921776769	tinarahangdale@gmail.com	Tina Rahangdale
27)	Mansi. F. Mhatre	8468891807	Mansi19182@gmail.com	Mansi
28)	Gargi L. Wadge	7972076671	gargiwadge@gmail.com	Gargi
29)	Vaishnavi. R. Lakhe	8669594864	chhakuvi.lakhe586@gmail.com	V. Lakhe
30)	Chhakuvi G. Wadikar	9825047987	Chhakuwadikar@gmail.com	Chhakuvi

Signature of:

Programme In-charge

Dr. Mrs. Yogita Morey (Dakuro)

ICAA COORDINATOR

INTERNAL QUALITY ASSURANCE CELL
DHARAMPETH, M. P. DEO MEMORIAL &
SCIENCE COLLEGE, NAGPUR

Principal

PRINCIPAL

Dharampeth M.P. Deo Memorial
Science College, Nagpur-440033



DHARAMPETH M. P. DEO MEMORIAL SCIENCE COLLEGE, NAGPUR
DEPARTMENT OF COMPUTER SCIENCE
ACADEMIC SESSION: 2022-23

NOTICE

5th November 2022

All the students of B.Sc.[SEM VI] are hereby informed that the Department of Computer Science, Dharampeth M.P.Deo Memorial Science College, Nagpur is going to organize Power Point Presentation Activity/Competition base on Unit II of Paper I[Visual Basic Programming] on 15th November 2022. All the students must remain present and participate in this activity.

Venue : Computer Science laboratory
Time : 11.15am

PRINCIPAL
DHARAMPETH M. P. DEO
MEMORIAL SCIENCE COLLEGE
NAGPUR

Head, Department of Computer Science
Head,
Department of Computer Science
Dharampeth M. P. Deo Memorial
Science College, Nagpur



**DHARAMPETH M. P. DEO MEMORIAL SCIENCE COLLEGE, NAGPUR
INTERNAL QUALITY ASSURANCE CELL (IQAC)**

Activity Report

Date: 30th November 2022

Name of Organizing Department or Committee: Computer Science Department

Name of the activity: Power Point Presentation Activity/Competition

Suggested CRITERION point if any: Criteria II,V

Date of Activity: 15th November 2022

Place of Activity: Computer Science laboratory

Name of Guest Speaker/s or Judge/s or Chief Guest/s if any: Nil

Title of the Activity: Power Point Presentation Activity/Competition on Functions of unit II Paper I [Visual Basic Programming] for the students of SEM V.

Number of Participants: 32

Name of the Teacher In-charge / Convener: Dr.Mrs.Snehal Narale

Names of other Committee Members / Staff: Nil

OUTCOME of the Activity with respect to mission vision of the institute and or academics:

The main objective of this activity to create sparks and curiosity in their mind related to the topic of their presentation from their syllabus.

- Conduction of Such activity helps the students to present their information in multiple ways (a multimodal approach) through the projection of color, images, and video for the visual mode.
- Students will be able to explore their ideas about the topic from their curriculum.
- It also helps to enhance their basic subject knowledge.
- Students will be able to enhance their intellect.
- Students learn the new as well as syllabus contents information in quicker as compare to the traditional methods.
- It also helps them to write better answers in their exams
- Students will be able to understand hoe to develop job skills in them for their better future prospects.

Activity with newspaper coverage if any: Nil

Activity data save in PC of: Dr. Mrs. Snehal Narale's Laptop



Prof.Pitambar Humane
IQAC Coordinator
IQAC Co-ordinator

Dharampeth M.P. Deo Memorial
Science College, Nagpur-440033

Dr.Mrs.Snehal Narale

Name &Signature of Teacher In-charge

Dr.AkhileshPeshwe
Principal
Principal

Dharampeth M.P. Deo Memorial
Science College, Nagpur.



DHARAMPETH M. P. DEO MEMORIAL SCIENCE COLLEGE,
North Ambazari Road, Near Ambazari Lake, Nagpur- 480033

DATA VALIDATION & VERIFICATION (DVV)

Name of the Programme : Power point presentation Activity [B.Sc. Sem V]
Date of the Programme : 15/11/2022
Name of Chief Guest if any : _____
Name of Guest Speaker if any : _____

Sr. No.	Name of the Participant	Mobile Number	E-mail Id	Signature
1	Ritu L. Choudhary	8180962189	ritulalit.choudhary@gmail.com	
2	Seema M. Lakda	7058728070	seemalakda9073@gmail.com	
3	Sevi A. Raj	8355999508	Sonawankar17@gmail.com	
4	Samiksha R. Khosare	9604473539	rekha.khosare@gmail.com	
5	Ku. Sujata Phansaj. Sonwane	801155140	suajatasonwane2001@gmail.com	
6	Shivani G. Ghubade	8637768062	shivani.ghubade08@gmail.com	
7	Samiksha V. Tabhare	8307133863	samikshavtabhare@gmail.com	
8	Tanu S. Mohule	7057844332	tanumohule19@gmail.com	
9	Komal M. Kumbhaze	7620314869	kumbhaze.komal294@gmail.com	
10	Neha J. Barkar	8055477553	nha2001barkar@gmail.com	

Signature of:
Head,
Department of Science
Dharampeth M. P. Deo Memorial
Science College, Nagpur

COORDINATOR
INTERNAL QUALITY ASSURANCE CELL
DHARAMPETH, M. P. DEO MEMORIAL &
SCIENCE COLLEGE, NAGPUR

Principal
Dharampeth M. P. Deo Memorial
Science College, Nagpur



DHARAMPETH M. P. DEO MEMORIAL SCIENCE COLLEGE,
North Ambasari Road, Near Ambasari Lake, Nagpur-440033

DATA VALIDATION & VERIFICATION (DVV)

11	Khushi A. Gupta	9923993285	kg098730@gmail.com	Khushi
12	Dikshita P. Sahane	9028830801	dikshitasahane@gmail.com	Dikshita
13	Pranjal D. Sawarkar	7385458510	pranjal10001234@gmail.com	Pranjal
14	Rushika S. Bhargava	9527232686	rushikasbhargava@gmail.com	Rushika
15	Diya R. Patil	7757052463	diyapati1553@gmail.com	Diya
16	Sahil R. Jivtade	9373414643	sahiljivtade73@gmail.com	Sahil
17	Runag S. Dore	8830629245	runagrunag577@gmail.com	Runag
18	Tanmay S. Gudam	7262034396	tanmay.gudam10@gmail.com	T.S. Gudam
19	Bhavesh R. Maske	7989351631	bhaveshmaske2003@gmail.com	Bhavesh M.
20	Bhavesh R. Mithun	9021317056	bhaveshm19112001@gmail.com	Bhavesh
21	Jarang P. Patil	8942248304	jarangpatil1001@gmail.com	J.P.
22	Abhishek A. Falke	7823835535	abhishekfalke1001@gmail.com	Abhishek
23	Khushi D. Dore	9890009937	kd8587977@gmail.com	Khushi
24	Sanchit Joshi	8975706788	sanchit-joshi01@gmail.com	Sanchit
25	Preeti M. Gadane	3715262138	Preetimosh.gadane@gmail.com	Preeti
26	Arshikesh R. Detha	8788155260	Arshikesh.detha1001@gmail.com	Arshikesh

Signature of:

[Signature]

Programme In Charge
Department of Computer Science
Dharampeth M. P. Deo Memorial
Science College, Nagpur

CO ORDINATOR

INTERNAL QUALITY ASSURANCE CELL
DHARAMPETH M. P. DEO MEMORIAL &
SCIENCE COLLEGE, NAGPUR

[Signature]

Principal
Dharampeth M. P. Deo Memorial
Science College, Nagpur.



DHARAMPETH M. P. DEO MEMORIAL SCIENCE COLLEGE, NAGPUR
INTERNAL QUALITY ASSURANCE CELL (IQAC)
Activity Report

Date: 23/01/2023

Name of Organizing Department or Committee:

Name of the activity: Story Writing Competition

Suggested CRITERION point if any: Criteria V

Date of Activity: 15-11-2022

Place of Activity: College

Name of Guest Speaker/s or Judge/s or Chief Guest/s if any: Nil

Title of the Activity: Story Writing Competition

Number of Participants: 105

Name of the Teacher In-charge / Convener: Dr.Mrs.Shraddha Deshpande

Names of other Committee Members / Staff: Dr.Akhilesh Peshwe (Principal)

OUTCOME of the Activity with respect to mission vision of the institute and or academics:

Students were asked to write their experiences on forgiveness, goodwill and brotherhood in the form of stories. In the process students could share their stories and were counselled by the teacher about it too.

Activity with newspaper coverage if any: Nil

Activity data save in PC of: English Department

Prof. Pitambar Humane
IQAC Coordinator

Dr.Mrs. Shraddha Deshpande
Teacher Incharge

Dr. Akhilesh Peshwe
Principal
Dharampeth M.P. Deo Memorial
Science College, Naggur.



Dharampeth M.P.Deo Memorial Science College, Nagpur
Department of English

NOTICE

Academic Session 2022-2023

STORY WRITING COMPETITION



All the students are hereby informed that English Department is organizing A Story Writing Competition on following themes:

1. Forgiveness
2. Good will
3. Brotherhood

- Story should be original.
- Story should be in 500 words.
- Story should be in English Language only.
- Story should be submitted on **15th November 2022**, at 1.00.p.m in Room. No. 10.

Dr. Shraddha Deshpande
Head,
Department of English
13/10/22

Dr. Shraddha Deshpande
Head, Department of English
Dharampeth M.P. Deo Memorial
Science College, Nagpur



DHARAMPETH M. P. DEO MEMORIAL SCIENCE COLLEGE,
North Ambazari Road, Near Ambazari Lake, Nagpur- 440033

DATA VALIDATION & VERIFICATION (DVV)

Name of the Programme : Story Writing
Date of the Programme : 15th Nov. 2022
Name of Chief Guest if any : _____
Name of Guest Speaker if any : _____

Sr. No.	Name of the Participant	Mobile Number	E-mail Id	Signature
1	Trushabh D. Saha	7985310571	trushabh.saha2004@gmail.com	
2	Kashish K. Bisen	7887886117	kashishbisen05@gmail.com	
3	Isha T. Waghmare	8855919474	ishawaghmare3474@gmail.com	
4	Chetna S. Buiwre	8010342968	buiwrechetna@gmail.com	
5	Bhagyashali D. Neware	7796434177	Sakshineware2017@gmail.com	
6	Monali N. Shende	7796516257	shendemonali192@gmail.com	
7	Ved. S. Chaudhary	7498572768	vedchoudhary.cs749@gmail.com	
8	Vedant A. Umethkar	9049932753	UmethkarVedant@gmail.com	
9	Abhishek R. Singh	8208948107	abhi0882005@gmail.com	
10	Uday C. Baghele	8459549609	bagheleuday@gmail.com	

Signature of:

Dr. Shradha Deshpande
Head, Department of English
Dharampeth M.P. Deo Memorial
Science College, Nagpur

CO-ORDINATOR
IQAC Coordinator
INTERNAL QUALITY ASSURANCE CELL
DHARAMPETH, M. P. DEO MEMORIAL &
SCIENCE COLLEGE, NAGPUR

Principal
Principal
Dharampeth M.P. Deo Memorial
Science College, Nagpur



DHARAMPETH M. P. DEO MEMORIAL SCIENCE COLLEGE,
North Ambazari Road, Near Ambazari Lake, Nagpur- 440033

DATA VALIDATION & VERIFICATION (DVV)

11.	Siddhi. B. Jiwani	8087143696	siddhijiwani021@gmail.com	
12.	Jagauti. G. Felkare	8767911807	Jagautifelkare@gmail.com	
13.	Amay S Kaur	9028837552	kaur7817@gmail.com	
14.	Sausabh Chaudhary	9359883501	schaudhary5599@gmail.com	
15.	Sakshi Chaudhary	9766341962	sakshichaudhary773399	Sakshi
16.	Vidya Lohi	7020983219	Vidyalohi8@gmail.com	
17.	Purachi Craybhaye	9763765826	Purachicraybhaye0967@gmail.com	
18.	Shivam Patel	7038889083	sp040263@gmail.com	Shivam
19.	Mahima Klare	9545918678	mahimaklare1@gmail.com	
20.	Divyani G. zade	7972403069	divyanizade2005@gmail.com	Zade
21)	Vaideli Nagarkar	9325963446	vaidelinagarkar07@gmail.com	
22)	Ankit Patel	9970905638	ankitpatel797271@gmail.com	

Signature of:

Program In-charge

Dr. Shradha Deshpande
Head, Department of English
Dharampeth M.P. Deo Memorial
Science College, Nagpur

IQAC Coordinator
IQAC Co-ordinator
Dharampeth M.P. Deo Memorial
Science College, Nagpur-440033

PRINCIPAL

Dharampeth M.P. Deo Memorial
Science College, Nagpur-440033

story.



DHARAMPETH M. P. DEO MEMORIAL SCIENCE COLLEGE,
North Ambazari Road, Near Ambazari Lake, Nagpur- 440033

DATA VALIDATION & VERIFICATION (DVV)

23	TANU. AJAY. SINGH	8806355808	tanusingh63492@gmail.com	Tanu
24	Meenal. Animesh. Choudhary	9529014604	Meenalchoudhary2004@gmail.com	Meenal
25	Veena Borikar	9322016921	veenaborikar19@gmail.com	Meenal
26	Vaishnavi Namdev Tonge	8421657943	Vaishnavitonge2004@gmail.com	Tonge
27	Janhvi Mahadeo Joge	7385060871	Janhvijoge05@gmail.com	Janhvi
28	Diyaani V. Zagade	9022866318	diyaanizagade@gmail.com	Zagade
29	Pranali R. Debnakar	8767581278	Pdebnar@gmail.com	Pranali R D
30	Samiksha A. Panchbudhe	9763075890	samikshapanchbudhe363@gmail.com	Samiksha
31	Janhvi H. Laibeh	8446510539	Jhanvilaibeh@gmail.com	Laibeh
32	Rutika Yadav	8446085943	yadavrutika@gmail.com	Yadav
33	Anjali Meshram	9767905772	anjali meshram 202@gmail.com	Anjali
34	Apeksha D. Katongale	7559455794	apekshakatongale.26@gmail.com	Katongale
35	Sonal Choudhary	8855819748	sonalchoudhary19@gmail.com	Sonal
36	Sakshi Mishra	9529889315	Smishra39683@gmail.com	Sakshi
37	Varsha Turkar	9373650950	varshaturkar482@gmail.com	Turkar

Signature of:

Dr. Shrawan D. Deshpande
Head, Department of English
Dharampeth M.P. Deo Memorial
Science College, Nagpur

IQAC Coordinator
Dharampeth M.P. Deo Memorial
Science College, Nagpur-440033

Principal
Dharampeth M.P. Deo Memorial
Science College, Nagpur-440033

Story



DHARAMPETH M. P. DEO MEMORIAL SCIENCE COLLEGE,
North Ambazari Road, Near Ambazari Lake, Nagpur- 440033

DATA VALIDATION & VERIFICATION (DVV)

38	Jadnyik Dhage	8623062678	ysdhage0106@gmail.com	YSD.
39	Kartik Mize	9604792402	kartikmize200@gmail.com	Kartik
40	Jagruti Fulkarwar	8767911807	Jagrutifulkarwa@gmail.com	JLKS
41	Tushal Achare	9575995617 achare tushal	achare tushal@gmail.com	Tushal
42	Prachi Paradhi	7263935912	prachiparadhi282@gmail.com	P.412
43	Prachi Chaybhaye	9763765826	prachichaybhaye1967@gmail.com	Prachi
44	Kastika M. Deshmukh	9699720960	kastikamel20@gmail.com	Kastika
45	Siddhi R. Jiwani	8087143696	siddhijiwani0721@gmail.com	Siddhi
46	Aman S. Karn	9028837552	karn7817@gmail.com	Aman
47	Monika T. Patel	7499225468	Monikapatel7038@gmail.com	M. Patel
48	Pratibha Bhusari	7821048413	pbhusari718@gmail.com	Pratibha
49	Shital C. Patle	9764596337	Shitalpatle12@gmail.com	Shital
50	Divyani G. Zade	7972403069	divyanizade2005@gmail.com	Divya
51	Shrutika G. Pise	9322316336	shrutikapise67@gmail.com	Shrutika
52	Sannabh Chaudhary	9359883501	Schaudhary5599	Sannabh
53	Shivam Patel	7038889083	Sp040263@gmail.com	Shivam

Signature of 53 Ritika R. Bhoyar

9766341962
9834587087
7488572706
7038889083
9322316336
9049932753

Sakshi Chaudhary 7753
ritikabhoyar28@gmail.com
vedchoudhary-cs249@gmail.com
Vidyobhu 8@gmail.com
Tej 8746@gmail.com
vedantamurthy@gmail.com

Sakshi
Principal
Vedant

Dr. Shrabdha Deshpande
Head, Department of English
Dharampeth M. P. Deo Memorial Science College

Programme In-charge
Vedantamurthy
Vedantamurthy

Handwritten signature





DHARAMPETH M. P. DEO MEMORIAL SCIENCE COLLEGE,
North Ambazari Road, Near Ambazari Lake, Nagpur- 440033

DATA VALIDATION & VERIFICATION (DVV)

65)	Lucky A Vishwakarma	9579660186	lvvishwakarma29@gmail.com @ Vishwakarma
66)	Abhay P. Tembhore	8975363145	abhay230102@gmail.com Abhay
67)	Nitu B. Rai	7058639984	niturai1919@gmail.com Nitu
68)	Nisha -v. Pandey	8605231390	abhishek.8605231390@gmail.com Nisha
69)	Priya Sharma	8010964349	priya19012004sharma@gmail.com Priya
70)	Anjali R Thakre	7066554821	thakreanjura81@gmail.com Anjali
71)	Manthavi-M. Todase	8080870430	manthavitodase@gmail.com Manthavi
72)	Sanjana .S. Tabhane	9699186571	tabhaneSanjana@gmail.com Sanjana
73)	Prameli R. Debankar	8767581078	prameli@gmail.com Prameli
74)	Himanshi Kalbande	9665301444	kalbandehimanshi@gmail.com Himanshi
75)	Nishu Kesarkar	98910996645	Nishukar@gmail.com Nishu
76)	Vaidhree B. Gangad.	9750790728	gangadhaidhree@gmail.com Vaidhree
77)	Sejal D. Kolhe	8483045985	Kolhesejal04@gmail.com Sejal
78)	Anag Barkar	9168538614	anagbarkar19@gmail.com Anag
79)	Sanyak M. Hadke	7020171304	Sanyakhadke30@gmail.com Sanyak

Signature of:

Dr. S. Pradipande
Head, Department of English
Dharampeth M. P. Deo Memorial
Science College, Nagpur

CO-ORDINATOR
IQAC Coordinator
INTERNAL QUALITY ASSURANCE CELL
DHARAMPETH, M. P. DEO MEMORIAL &
SCIENCE COLLEGE, NAGPUR

Principal
Dharampeth M.P. Deo Memorial
Science College, Nagpur.



DHARAMPETH M. P. DEO MEMORIAL SCIENCE COLLEGE,
North Ambazari Road, Near Ambazari Lake, Nagpur- 440033

DATA VALIDATION & VERIFICATION (DVV)

80)	Anshul - Y. Kinnapure	9294067163	anshulkinnapure650@gmail.com	Anshul
81)	Krutika S. Bkale	9021533341	pokalekrutika6@gmail.com	Krutika
82)	Riya A. Singh	9595649831	riya232307@gmail.com	R Singh
83)	Shreya A. Jha	8983236002	Sangeetajha0303@gmail.com	Jha
84)	Yachana K. Pandey	9156035297	pandeykr54@gmail.com	Pandey
85)	Sunaina P. Chichonde	8530970132	SunainaChichonde@gmail.com	Chichonde
86)	Aakansha Y. mairal	8010923662	aakanyagi2004@gmail.com	Aymairal
87)	Rally K. Nayari	9326013213	kaikhanayari12345@gmail.com	Rally
88)	Shamali L. Umam	9280209530	shamali00mull1912@gmail.com	Shamali
89)	Komalika S. chandhari	9322033866	KomalikaChandhari073@gmail.com	Komalika
90)	Devashree P. Kakde	9021344265	leakeledevashree@gmail.com	D.P. Kakde
91)	Ghanashree U. Dhomane	8459807097	ghanashreedhomane@gmail.com	Dhomane
92)	Apeksha D. Katangale	7559455794	apekshakatangale26@gmail.com	Akatangale
93)	Pranali Y. Chavhan	9699654562	pranaliChavhan65@gmail.com	Chavhan
94)	Chanchal K. Waghwan	7796016894	waghwanitara@gmail.com	Chanchal

Signature of:

Programme In-charge

CO-ORDINATOR
INTERNAL QUALITY ASSURANCE CELL
DHARAMPETH, M. P. DEO MEMORIAL &
SCIENCE COLLEGE, NAGPUR

Principal
Dharampeth M.P. Deo Memorial
Science College, Nagpur.



DHARAMPETH M. P. DEO MEMORIAL SCIENCE COLLEGE,
North Ambazari Road, Near Ambazari Lake, Nagpur- 440033

DATA VALIDATION & VERIFICATION (DVV)

95)	Duggesh K. Ghodmare	9075318618	duggeshghodmare0011@gmail.com	<u>Duggesh</u>
96)	Neha .L. Manjari	9375832266	nehawanjari733@gmail.com	<u>Neha</u>
97)	Shruti channekar	9699823842	shrutkhannekar76@gmail.com	<u>Shruti</u>
98)	Gauri Bhogare	8668335876	gauribhogare39@gmail.com	<u>Gauri</u>
99)	Bhanali V. Gupta	7020069377	vg991537@gmail.com	<u>Bhanali</u>
100)	Ruchi . P. Queivedi	8080776898	ruchitwinedi230@gmail.com	<u>Ruchi</u>
101)	Mounali D. Bhillkar	9922727616	mounalibhillkar@gmail.com	<u>Mounali</u>
102)	Nihal V. Meshram	8767742900	nihalmeshram74@gmail.com	<u>N.V. Meshram</u>
103)	Tejus R Chetmelwar	9606662119	tejuschetmelwar@gmail.com	<u>Tejus</u>
104)	Badal Gendal Samkuwar	7448247750	badalsamkuwar1@gmail.com	<u>Badal</u>
105)	Divyani G. Zade	7972403069	divyanizade2005@gmail.com	<u>Divya</u>

Signature of:

Program In-charge
Head, Department of English
Dharampeth M. P. Deo Memorial
Science College, Nagpur.

CO-ORDINATOR
INTERNAL QUALITY ASSURANCE CELL
DHARAMPETH, M. P. DEO MEMORIAL &
SCIENCE COLLEGE, NAGPUR

Principal
Dharampeth M.P. Deo Memorial
Science College, Nagpur.



DHARAMPETH M. P. DEO MEMORIAL SCIENCE COLLEGE, NAGPUR
INTERNAL QUALITY ASSURANCE CELL (IQAC)

Activity Report

Date: 30/11/2022

Name of Organizing Department or Committee: Computer Science

Name of the activity: Poster or Chart Making Activity

Suggested CRITERION point if any: V

Date of Activity: 15/11/2022

Place of Activity: Computer Science Laboratory

Name of Guest Speaker/s or Judge/s or Chief Guest/s if any: NA

Title of the Activity: Construction of E-R Model to show relationship between entities of the organization.

Number of Participants: 25

Name of the Teacher In-charge / Convener: Mrs. Ruma Kapre

Names of other Committee Members / Staff: NA

OUTCOME of the Activity with respect to mission vision of the institute and or academics:

Construction of E-R Model in the form of poster or chart improves the ability of the students to draw E-R diagram by using all universal symbols which are required to draw E R Diagram. It enhances the ability of thought process of the students as they have to think each and every aspect if they want to show the relationships between entities of the organization. And then put that thought process diagrammatically in the form of E R Model. Students tried to put efforts in the activity and finished up with good poster/chart.

Activity with newspaper coverage if any: NA

Activity data save in PC of: Mrs. Ruma Kapre



Prof. Pitambar Humane
IQAC Coordinator

CO ORDINATOR
INTERNAL QUALITY ASSURANCE CELL
DHARAMPETH, M. P. DEO MEMORIAL &
SCIENCE COLLEGE, NAGPUR

Mrs. Ruma Kapre
Name & Signature of Teacher In-charge

Dr. Akhilesh Peshwe
Principal

Principal
Dharampeth M.P. Deo Memorial
Science College, Nagpur.



DHARAMPETH M. P. DEO MEMORIAL SCIENCE COLLEGE,
North Ambazari Road, Near Ambazari Lake, Nagpur- 440033

DATA VALIDATION & VERIFICATION (DVV)

Name of the Programme

: Poster or Chart Making Activity [SEM V : UNIT II]

Date of the Programme

: 15/11/2022

Name of Chief Guest if any

: _____

Name of Guest Speaker if any

: _____

Sr. No.	Name of the Participant	Mobile Number	E-mail Id	Signature
1.	Sanchit Joshi	8975706788	sanchit.joshi.01@gmail.com	
2.	Jarang P. Pawke	9422488044	jarangpawke2001@gmail.com	
3.	Abhishek A. Fulke	7823835535	abhishek.pawke88@gmail.com	
4.	Seema M. Lakda	7058728070	seemalakda073@gmail.com	
5.	Soni A. Rai	9855989509	sonianurait@gmail.com	
6.	Samiksha R. Khalare	9604473539	samikhakhalare@gmail.com	
7.	Shivani G. Ghubade	8637768062	shivanghubade080@gmail.com	
8.	Samiksha Rabhane	9307133863	samikhavrabhane@gmail.com	
9.	Tanvi S. Mohule	7057844382	tanvimohule95@gmail.com	
10.	Khushi Dave	9890009937	kd8587477@gmail.com	

Signature of:

Programme In-charge

Mrs. Ruma Kapre

IQAC Coordinator

CO ORDINATOR

INTERNAL QUALITY ASSURANCE CELL
DHARAMPETH, M. P. DEO MEMORIAL &
SCIENCE COLLEGE, NAGPUR

Principal
Principal

Dharampeth M.P. Deo Memorial
Science College, Nagpur.



DHARAMPETH M. P. DEO MEMORIAL SCIENCE COLLEGE,
North Ambazari Road, Near Ambazari Lake, Nagpur- 440033

DATA VALIDATION & VERIFICATION (DVV)

11.	Bhanjal Dhatmenbhai Sonwalkar	7385458510	bhanjalbhanu2234@gmail.com	Bhanwalkar
12.	Ruchita S. Bhoyar	9527832686	ruchitabhoyar07@gmail.com	Rbhoyar
13.	Sahil R. Jivtode	9373414643	sahiljivtode73@gmail.com	Sahil
14.	Tanmay S. Gadam	7262034386	tanmaygadaml@gmail.com	T. S. Gadam
15.	Bhavesh D. Mathur	9021317056	bhaveshmathur19112001@gmail.com	Bmathur
16.	Khushi A. Gupta	9922997235	kg098920@gmail.com	Kgupta
17.	Komal M Kumbhar	7620314869	Kumbhar_komal94@gmail.com	Komal
18.	Ritu L. Choudhary	8180962189	ritulalit.chaudhary@gmail.com	Rchoudhary
19.	Bhavesh R. Maske	7989951631	bhaveshmaske2002@gmail.com	Bhavesh M.
20.	Pranay S. Dore	8830629245	pranay523@gmail.com	Pranay
21.	Diya R. Patil	7757052463	diyapatil553@gmail.com	Dpatil
22.	Kusajata Phorraj Sonwane	9081135140	suajatasonwane2001@gmail.com	Kusajata
23.	Neha J. Bankar	8055477553	neha2002bankar@gmail.com	Nbankar
24.	Dikshita P. Senhare	9028830801	dikshitaseshare@gmail.com	Dikshita
25.	Rishikesh R. Detha	8788199260	rishikeshdetha2000@gmail.com	Rdetha

Signature of:

Programme In-charge

IQAC Coordinator

CO ORDINATOR

INTERNAL QUALITY ASSURANCE CELL
DHARAMPETH, M. P. DEO MEMORIAL &
SCIENCE COLLEGE, NAGPUR

Principal

Principal
Dharampeth M.P. Deo Memorial
Science College, Nagpur.



DHARAMPETH M. P. DEO MEMORIAL SCIENCE COLLEGE, NAGPUR
INTERNAL QUALITY ASSURANCE CELL (IQAC)
Activity Report

Name of Organizing Department or Committee: Microbiology Department **Date:** 15/11/2022
Name of the activity: NEP Activity
Suggested CRITERION point if any: Criterion II
Date of Activity: 15/11/2022
Place of Activity: Department of Microbiology
Name of Guest Speaker/s or Judge/s or Chief Guest/s if any: Guest Speaker - Nil
Title of the Activity: Project report on Applications of Electrophoresis, Chromatography In Medical Sciences
Number of Participants: 28
Name of the Teacher In-charge / Convener: Dr. Mrs Vaishali Pimple
Names of other Committee Members: Nil
OUTCOME of the Activity with respect to mission vision of the institute and or academics:
Students understood the applications of electrophoresis and chromatography in diagnostic techniques.
Activity with newspaper coverage any: Nil

Name & Signature of Teacher In-charge

Prof. Pitambar Humane
IQAC Coordinator

CO ORDINATOR
INTERNAL QUALITY ASSURANCE CELL
DHARAMPETH, M. P. DEO MEMORIAL &
SCIENCE COLLEGE, NAGPUR

Dr. Akhilesh Peshwe
Principal

Principal
Dharampeth M.P. Deo Memorial
Science College, Nagpur.

5/11/21



DHARAMPETH M. P. DEO MEMORIAL SCIENCE COLLEGE,
North Ambazari Road, Near Ambazari Lake, Nagpur-440033

DATA VALIDATION & VERIFICATION (DVV)

Name of the Programme: Project Report on Applications of Electrophoresis, Chromatography

Date of the Programme: _____

Name of Chief Guest if any: Nil

Name of Guest Speaker if any: Nil

Sr. No.	Name of the Participant	Mobile Number	E-mail Id	Signature
1	Anjali B. Pali	7498102109	pali.anjali144@gmail.com	[Signature]
2	Nandini Suresh Haldge	9310301679	nandini.suresh17@gmail.com	[Signature]
3	Vivek P. Patil	9956482591	vivek.patil19@gmail.com	[Signature]
4	Bhargavi A. Samiksha	7709409806	bhargavi.samiksha@gmail.com	[Signature]
5	Tshika A. Thakre	8019101089	ishithakre2@gmail.com	[Signature]
6	Shruti M. Pawar	8521988707	shruti.pawar4001@gmail.com	[Signature]
7	Shreyanshi S. Naitkwar	7447544169	shreyanshinaitkwar10@gmail.com	[Signature]
8	Samiksha N. Kundekar	9145253158	samiksha.kundekar@gmail.com	[Signature]
9	Samiksha R. Chaudhari	7571090406	chaudhari.samiksha26@gmail.com	[Signature]
10	Ayushi Shukla	9373668043	ayushishukla28112002@gmail.com	[Signature]

Signature of: [Signature]
Programme In-charge

[Signature]
IQAC Coordinator

[Signature]
Principal

DHARAMPETH M. P. DEO MEMORIAL SCIENCE COLLEGE,
North Ambazari Road, Near Ambazari Lake, Nagpur- 440033

DATA VALIDATION & VERIFICATION (DVV)

11.	Anurag. Wale	8530778433	anuragwale2008@gmail.com	(Anurag)
12.	Madhura. U. Bhandare	8767484914	Madhuraabhandare@gmail.com	Madhura
13.	Krushali S. Kade	8625854995	krushalikade87@gmail.com	Krushali
14.	Bhuma D. Chedde	8830391103	bhumitachedge@gmail.com	Bhuma
15.	Karima. S Bamsale	7385812507	karimabamsale@gmail.com	Karima
16.	Rashmi M. Bhandal	9325853468	rashmi2018bb@gmail.com	Rashmi
17.	Neha J. Chandekar	9310570893	nehachenchandr216@gmail.com	Neha
18.	Anika R. Bhoyar	9788031173	Anikabhoyar@gmail.com	Anika
19.	Mandali. S. Shinde	72496387434	mandalishinde062@gmail.com	Mandali
20.	Sayli S. Lokhande	9356413804	sayelokhande2910@gmail.com	Sayli
21.	Isha B. Gupta	9373259849	isha202gupta@gmail.com	Isha
22.	Ashra Sakhasane	9405197842	ashrasakhasane@gmail.com	Ashra
23.	Gyaneshi Shigat	758367942	shigatshigat@gmail.com	Gyaneshi
24.	Pranjali L. Dandae	9325473319	dandaelianjali@gmail.com	Pranjali
25.	Aranti. A. Chaphekar	7875173847	aranti11@gmail.com	Aranti

Signature of:
(Signature)

(Signature)
INTERNAL QUALITY ASSURANCE CELL
DHARAMPETH M. P. DEO MEMORIAL SCIENCE COLLEGE
NAGPUR

Principal
Dharampeth M.P. Deo Memorial
Science College, Nagpur



DHARAMPETH M. P. DEO MEMORIAL SCIENCE COLLEGE, NAGPUR
INTERNAL QUALITY ASSURANCE CELL (IQAC)

Activity Report

Date: 15.11.2022

Name of Organizing Department or Committee: Dept. of Home Science

Name of the activity: Discussion on Improving Geriatric Care At Home (NEP 2022 Activity)

Suggested CRITERION point if any:

Date of Activity: 15.11.2022

Place of Activity: Classroom, Dept. of Home Science

Name of Guest Speaker/s or Judge/s or Chief Guest/s if any:

Title of the Activity: Discussion on Improving Geriatric Care At Home

Number of Participants: 12

Name of the Teacher In-charge / Convener: Mrs. Meghna Pandit

Names of other Committee Members / Staff:

OUTCOME of the Activity with respect to mission vision of the institute and or academics:

To develop understanding of the importance of geriatric care at home and come up with innovative solutions to problems related to geriatric care at home.

Activity with newspaper coverage if any:

Activity data save in PC of:

Note: Kindly share geotag photographs separately along with report on iqacdsc2022@gmail.com

Prof. Pitambar Humane
IQAC Coordinator
CO ORDINATOR
INTERNAL QUALITY ASSURANCE CELL

Name & Signature of Teacher In-charge:
(Mrs. Meghna Pandit) Science College, Nagpur

Dr. Akhilesh Peshwe
PRINCIPAL
DHARAMPETH M. P. DEO
MEMORIAL SCIENCE COLLEGE
NAGPUR



DHARAMPETH M. P. DEO MEMORIAL SCIENCE COLLEGE,
North Ambazari Road, Near Ambazari Lake, Nagpur - 440033

DATA VALIDATION & VERIFICATION (DVV)

Name of the Programme : Discussion on Improving Geriatric care at home
Date of the Programme : 15/11/2022
Name of Chief Guest if any : _____
Name of Guest Speaker if any : _____

Sr. No.	Name of the Participant	Mobile Number	E-mail id	Signature
1.	Mahima Wankhede	7821883251	mahimawankhede7@gmail.com	Mahima
2.	Mayuri Mali	7498065023	Mayurimali180@gmail.com	Omali
3.	Ananya Meshre	9284834439	ananyameshre@gmail.com	Ananya
4.	Sushmita Mallick	9334916560	sushmita70@gmail.com	Sushmita
5.	Riya Shewkar	7249070278	shewkaroriniga@gmail.com	Riya
6.	Vanshika Todase	7447275658	vanshikatodase@gmail.com	Vanshika
7.	Vaishnavi Bahadure	9284679244	vaishnavibahadure3@gmail.com	Vaishnavi
8.	Aashi Raut	8625813184	aaraut0809@gmail.com	Aashi
9.	Pooja Chute	9552381386	lxmichute123@gmail.com	PChute
10.	Sakshi Thosar	8177911360	sakshithosar62@gmail.com	SThosar

Signature of:

Program in-charge

CO-ORDINATOR
INTERNAL QUALITY ASSURANCE CELL
DHARAMPETH, M. P. DEO MEMORIAL &
SCIENCE COLLEGE, NAGPUR

Principal
PRINCIPAL
Dharampeth M. P. Deo Memorial
Science College, Nagpur-440033



DHARAMPETH M. P. DEO MEMORIAL SCIENCE COLLEGE, NAGPUR
INTERNAL QUALITY ASSURANCE CELL (IQAC)

Activity Report

Date: 15-11-2022

Name of Organizing Department or Committee: Department of Statistics

Name of the activity: Fit an exponential trend to the given data.

Suggested CRITERION point if any:

Date of Activity: 15th November 2022

Place of Activity: Statistics lab

Name of Guest Speaker/s or Judge/s or Chief Guest/s if any:

Title of the Activity: Fit an exponential trend to the given data.

Number of Participants: 18

Name of the Teacher: Gauri Sinekar

Names of other Committee Members / Staff: N.A.

OUTCOME of the Activity with respect to mission vision of the institute and or academics:

Student get the knowledge about Exponential Distribution. With the help of Exponential Distribution, students fit to given data. How to analyse data of exponential distribution.

Activity with newspaper coverage if any: No

Activity data save in PC of: Department of Statistics

Prof. Pitambar Humane
IQAC Coordinator

CO ORDINATOR
INTERNAL QUALITY ASSURANCE CELL
DHARAMPETH, M. P. DEO MEMORIAL &
SCIENCE COLLEGE, NAGPUR

G. Sinekar
Name & Signature of Teacher In-charge

Dr. Akhilesh Peshwe
Principal
Principal
Dharampeth M.P. Deo Memorial
Science College, Nagpur.



DHARAMPETH M. P. DEO MEMORIAL SCIENCE COLLEGE NAGPUR

Department of Statistics

Class: B.Sc. Sem. - III

NEP ACTIVITY

Paper- II

Unit- IV

Name of the Teacher: Gauri S. Sinekar

Date: 15/11/22

Title of Activity: fit an Exponential trend to the given data.

Sr. No.	Name of Student	Batch	Mobile No.	Email ID	Signature
1	Ketan S. Bhoyar	Scom	9657957276	Ketanbhoyar53@gmail.com	
2	Harshal N. Ajankar	Scom	9527732358	Harshalajankar8@gmail.com	
3	Isha Nemade	Scom	7028494761	ishanemade72@gmail.com	
4	Vicky A. Singh	Scom	9884782931	vickysingh11092009@gmail.com	
5	Suman R. Singh	Scom	9322018536	sumanrsingh12345678@gmail.com	
6	Savitri B. Singh	Scom	9252260502	savitribsingh@gmail.com	
7	Prayakta Pawar	Scom	9356905751	prayakta2406@gmail.com	
8	Swamini S. Rajankar	Scom	9822200598	swaminirajankar@gmail.com	
9	Anjali V. Rangankar	Scom	8830031253	anjaliurangankar@gmail.com	
10	Aman Chavhan	Scom	7219486153	amanchavhan2@gmail.com	
11	Vrushali Shohore	Scom	9807516332	vrushalishohore25@gmail.com	
12	Purushottam Parasha	Scom	7010693071	parashapurushkato@gmail.com	
13	Saunthak Jichkar	Scom	8605710878	saunthakjichkar@gmail.com	
14	Aniket B. Bansod	Scom	7870841788	aniketbansod@gmail.com	
15	Sumit Sahil P	Scom	9322200598	sumitsahilp@gmail.com	
16	Devang Karia	Scom	7988238500	devangkaria@gmail.com	
17	Khushi Chagade	Scom	9156520783	khushichagade@gmail.com	
18	Vaishnavi Jadhav	Scom	9156910334	vtos06543@gmail.com	

G. Sinekar
Signature of Teacher

G. Sinekar
Teacher Incharge



Activity Report

Date : 20/1/22

Name of Organizing Department or Committee: Department of Chemistry

Name of the activity: NEP Activity Home Science Sem I Unit 4

Suggested CRITERION point if any: Criteria II

Date of Activity: 15/11/22

Place of Activity: Home Science Department 2nd floor

Name of Guest Speaker/s or Judge/s or Chief Guest/s if any: Nil

Title of the Activity: Preparation of colloidal solution and Tyndall effect

Number of Participants: 56

Name of the Teacher In-charge / Convener: Dr. Sandip Madhukar Bhiwagade

Names of other Committee Members / Staff: Dr. V. Meshram

OUTCOME of the Activity with respect to mission vision of the institute and or academics:

This is student centric activity. This activity helps to understand students very clearly properties of the colloidal particles. How scattering of light happens when light comes in the contacts with colloidal particles. It helps the students how to distinguish between reflection, transference and scattering property of light.

Activity with newspaper coverage if any : Nil

Activity data save in PC of: Department of Chemistry



(Dr. Sandip M. Bhiwagade)
Dr. Sandip M. Bhiwagade

Name & Signature of Teacher In-charge

(Prof. Pitambar Humane)

Prof. Pitambar Humane
IQAC Coordinator

(Dr. Akhilesh Peshwe)

Dr. Akhilesh Peshwe
Principal

CO ORDINATOR
INTERNAL QUALITY ASSURANCE CELL
DHARAMPETH, M. P. DEO MEMORIAL &
SCIENCE COLLEGE, NAGPUR

PRINCIPAL
Dharampeth M.P. Deo Memorial
Science College, Nagpur-440033

Name of Activity :- Preparation of colloidal solution and Tyrdall effect



DHARAMPETH M. P. DEO MEMORIAL SCIENCE COLLEGE,
North Ambazari Road, Near Ambazari Lake, Nagpur- 440033

DATA VALIDATION & VERIFICATION (DVV)

Date 15/11/2022

1	Laxmi M. Gaudle [CZM]	7758058514	laxmigaude2908@gmail.com	Laxmi Gaudle
2	Vishal Kumar Singh (PCM)	9610187223	singhvishal9602@gmail.com	Vishal
3	Aishwarya A. Joshi	7498328662	aishwaryajoshi2003@gmail.com	Aishwarya
4	Ishika S. Thakre	8010907069	ishithakre@gmail.com	Ishika
5	Shruti M. Pawar	9527988707	shrutipawar0707@gmail.com	Shruti
6	Tanmay V. Choudhari	8600102341	tanmaychoudhari@gmail.com	Tanmay
7	Sahil U. Bhodaswar	7507999271	sahilbhodaswar@gmail.com	Sahil
8	Harsh S. Singh	9011680573	harshusingh721@gmail.com	Harsh
9	Shubham T. Gupta	7038609520	sgshubhangupta79@gmail.com	Shubham
10	Snehal A. Bute	7058756570	snehalbute9218@gmail.com	Snehal
11	Prachi S. Waghale	8767914118	prachiwaghale103@gmail.com	Prachi
12	Aakash Ashok Srikar	9175422051	akabunakarh15@gmail.com	Aakash
13	Purnjoti Nagesh Gokurad	9130893362	gokuradpurnjoti39@gmail.com	Purnjoti
14	Bhargavi Abhijit Sankare	7709403806	bhargavisankare05@gmail.com	Bhargavi
15	Nandini Suresh Hadge	9870301679	nandinihadget1@gmail.com	Nandini

15/11/22

Signature of:

[Signature]
Programme In-charge

[Signature]

COORDINATOR
INTERNAL QUALITY ASSURANCE CELL
DHARAMPETH, M. P. DEO MEMORIAL &
SCIENCE COLLEGE, NAGPUR

[Signature]
Principal
PRINCIPAL

Dharampeth M.P. Deo Memr
Science College, Nagpur-44



DHARAMPETH M. P. DEO MEMORIAL SCIENCE COLLEGE,
North Ambazari Road, Near Ambazari Lake, Nagpur- 440033

15/11/22

DATA VALIDATION & VERIFICATION (DVV)

16]	Manish S. Gade (C2M)	9370329857	manishgade79@gmail.com	@mrcade
17]	Mukesh J. Oraon (PCM)	8379049368	Oraonm64@gmail.com	Mukesh
18]	Priyanshi P. Singh (PCM)	7219259020	priyanshisingh18070@gmail.com	Singh
19]	Akanksha R. Yelure (PCM)	8767935524	akankshayelure@gmail.com	Akanksha
20]	Rinam C. Wankhede (CBM)	8010966529	wankhede.rinamc@gmail.com	Rinam
21]	Sans Kunti S. Panchbhawe	7447613185	sanskuntispanchbhawe@gmail.com	Sans
22]	Shrushti U. Surjewanshi	8087317297	surjewanshishrushti@gmail.com	Shrushti
23]	Nikita D. Shebe	9021019101	nikita.shebe2019@gmail.com	Nikita
24]	Achal S. Wagh	9579643389	achal.wagh003@gmail.com	Achal
25]	Anushka S. Das	7058933157	ad04092001@gmail.com	Anushka
26]	Chaitali M. Burebade	9359540394	chaitali2020b@gmail.com	Chaitali
27]	Raksha D. Dhote	7498511875	rakshadhote3@gmail.com	Raksha
28]	Pallavi Y. Bhagat	9022654940	Pallaviy2208@gmail.com	Bhagat
29]	Pragya R. Jha	9665852975	pragya679@gmail.com	Pragya
30]	Shreyansh S. Naikwar	7447844199	shreyanshnaikwar7@gmail.com	Shreyansh

Signature of

Program In-charge

IQAC Coordinator

CO ORDINATOR
INTERNAL QUALITY ASSURANCE CELL
DHARAMPETH, M. P. DEO MEMORIAL
SCIENCE COLLEGE, NAGPUR

Principal

PRINCIPAL
Dharampeth M.P. Deo Memorial
Science College, Nagpur-440033

40.	Vivek R. Waburwagh	8356482531	vivekwaburwagh@gmail.com	Waburwagh
41.	Samiksha R. Choudhary	7517090406	choudharysauriksha26@gmail.com	Sfmg
42.	Sayali S. Lokhande	9356413804	sayalilokhande2910@gmail.com	Lokhande
43.	Adesh K. Hattwar	7517431162	adeshthattwar2002@gmail.com	A.K. Hattwar
44.	Samiksha N. Kunderkar	9145253758	samishkunderkar@gmail.com	Kunderkar
45.	Shivani S. Dwivedi	8855300546	shivandwivedi41@gmail.com	Dwivedi
46.	Artha A. Sakharwade	9405197842	arthasakharwade@gmail.com	Sakharwade
47.	Rishi N. Tathan	8669598198	Raikhans6604@gmail.com	Tathan
48.	Tanushree R. Date	976692740	tanushreedate27@gmail.com	R. Pathan
49.	Aditi K. Dhoble	8847709571	aditidhoble4@gmail.com	Date
50.	Poojaly L. Dandekar	9325473318	dandekarpujaly6@gmail.com	Dandekar
51.	Ayushi D. Shukla	9373668043	ayushishukla28112002@gmail.com	Shukla
52.	Krushnali S. Kadu	8625854995	krushnalikadu67@gmail.com	Kadu
53.	Poonam S. Chauragaole	8167765121	poonamchauragaole08@gmail.com	Chauragaole
54.	Tanmay Bhute	7697250831	tanmaybhute900@gmail.com	Bhute
55.	Shivam Mananya	9607873702	shivammananya123@gmail.com	Mananya
56.	Shweta B. Sawalkar	7721802906	Shwetabke77@gmail.com	Sawalkar



Activity Report

Date : 18/11/22

Name of Organizing Department or Committee: Department of Chemistry

Name of the activity: NEP Activity Home science Sem III Unit I

Suggested CRITERION point if any: Criteria II

Date of Activity: 15/11/22

Place of Activity: Home Science Department 2nd floor

Name of Guest Speaker/s or Judge/s or Chief Guest/s if any: Nil

Title of the Activity: Identification and colour reaction of Carbohydrates

Number of Participants: 16

Name of the Teacher In-charge / Convener: Dr. Sandip Madhukar Bhiwagade

Names of other Committee Members / Staff: Dr. Vaishali P. Meshram

OUTCOME of the Activity with respect to mission vision of the institute and or academics:

This activity helps to understand students how to identify different types of carbohydrate which are similar in appearance. In this activity students learn how one can distinguish glucose from fructose, glucose from starch and fructose from starch by using simple chemical reagent

Activity with newspaper coverage if any : Nil

Activity data save in PC of: Department of Chemistry



Prof. Pitambar Humane
IQAC Coordinator

CO ORDINATOR
INTERNAL QUALITY ASSURANCE CELL
DHARAMPETH, M. P. DEO MEMORIAL &
SCIENCE COLLEGE, NAGPUR

Name & Signature of Teacher In-charge

Dr. Akhilesh Peshwe
Principal

PRINCIPAL
Dharampeth M.P. Deo Memorial
Science College, Nagpur-440033

(Date) 15/11/22



DHARAMPETH M. P. DEO MEMORIAL SCIENCE COLLEGE,
North Ambazari Road, Near Ambazari Lake, Nagpur- 440033

DATA VALIDATION & VERIFICATION (DVV)

Name of the Programme : NEP Activity (Use of surfactant as emulsifier and preparation of emulsion)
Date of the Programme : 15/11/22
Name of Chief Guest if any : -
Name of Guest Speaker if any : -

Sr. No.	Name of the Participant	Mobile Number	E-mail Id	Signature
1.	Tejas V. Rewade	7796027056	tejasrewade88@gmail.com	
2.	Kaishant G. Hirkar	9579092921	kaishantg.hirkar1234@gmail.com	
3.	Kalpna D. Sehagpure	9579236712	Kalpanasehagpure7@gmail.com	
4.	Shubhanshu Wikej	702543177	shubhanshuwikej15@gmail.com	
5.	Ojasvi Wankhede	8767699751	wankhedojasvi@gmail.com	
6.	Avani Shewai	9096507459	avanshewais@gmail.com	
7.	Kimaya N. Kale	8866073792	KimayaKale03@gmail.com	
8.	Tanner B. Korde	7841984450	kordetanner13@gmail.com	
9.	Vaishnavi K. Pradhan	9763169560	pradhanvaishnavi15@gmail.com	
10.	Shrushti Patkar	4387067403	shrushtipatkar@gmail.com	

11.
Signature of:
Programme In-charge

ICA COORDINATOR
INTERNAL QUALITY ASSURANCE CELL
DHARAMPETH, M. P. DEO MEMORIAL &
SCIENCE COLLEGE, NAGPUR

PRINCIPAL
Dharampeth M.P. Deo Memorial
Science College, Nagpur-440033

Br. NO	Name	mobile	Email	Sign
11.	Bhagyashree S Ambule	9359139068	ambule.b667@gmail.com	<u>Ambule</u>
12)	Pallavi B. Katre	8459277408	pkatre.513@gmail.com	<u>Pallavi</u>
13)	Priya K. Khawshi	9763617224	priyakhawshi3@gmail.com	<u>Priya</u>
14)	Poochi. N. Laxkar	9806244419	Poochilaxkar.159@gmail.com	<u>Poochi</u>
15]	Mansr. N. Chaudhan	7720088783	chaudhanmansr921@gmail.com	<u>Mansr</u>
16]	Priya. u. maity	7350980367	maityupriya23@gmail.com	<u>Priya</u>



NEPActivity Report

Date : 18/11/22

Name of Organizing Department or Committee: Department of Chemistry

Name of the activity: NEP Activity Home science Sem III Unit II

Suggested CRITERION point if any: Criteria II

Date of Activity: 15/11/22

Place of Activity: Home Science Department 2nd floor

Name of Guest Speaker/s or Judge/s or Chief Guest/s if any: Nil

Title of the Activity: Application of Fermentation in day today life

Number of Participants: 16

Name of the Teacher In-charge / Convener: Dr. Sandip Madhukar Bhiwagade

Names of other Committee Members / Staff: Dr. Vaishali P. Meshram

OUTCOME of the Activity with respect to mission vision of the institute and or academics:

This activity helps to understand students the process behind the fermentation. The role of the enzymes during the fermentation, what are the ideal conditions required for fermentation. In this activity students also know the application of fermentation

Activity with newspaper coverage if any : Nil

Activity data save in PC of: Department of Chemistry



Dr. Sandip Bhiwagade
Bhiwagade

Name & Signature of Teacher In-charge

Prof. Pitambar Humane

Prof. Pitambar Humane
IQAC Coordinator

CO ORDINATOR
INTERNAL QUALITY ASSURANCE CELL
DHARAMPETH, M. P. DEO MEMORIAL &
SCIENCE COLLEGE, NAGPUR

Dr. Akhilesh Peshwe
Principal

PRINCIPAL
Dharampeth M.P. Deo Memorial
Science College, Nagpur-440033



DHARAMPETH M. P. DEO MEMORIAL SCIENCE COLLEGE,
North Ambazari Road, Near Ambazari Lake, Nagpur- 440033

DATA VALIDATION & VERIFICATION (DVV)

Name of the Programme : Application of fermentation in day to day life
Date of the Programme : 15/11/2022
Name of Chief Guest if any : _____
Name of Guest Speaker if any : _____

Sr. No.	Name of the Participant	Mobile Number	E-mail Id	Signature
1.	Ashwini N. Pandey	8308621078	ashwinipandey989@gmail.com	<u>Ashwini</u>
2.	Minal L. Patle	7350730164	patleminal83@gmail.com	<u>Minal</u>
3.	Shalu T. Pawdhi	8829115380	shalupawdhi3@gmail.com	<u>Shalu</u>
4.	SAKSHI R. CHARUNDE	78430108801	SAKSHICHARUNDE@gmail.com	<u>SChakunde</u>
5.	Neha R. Vishwakarma	8983524175	nehavishwakarma85285@gmail.com	<u>Neha</u>
6.	Astha P. Bhowrey	9156003306	asthabhowrey@gmail.com	<u>Bhowrey</u>
7.	Aditi R. Vaidya	8075714591	aditivaidya619@gmail.com	<u>Ad</u>
8.	Anshikha U. Jaisankar	9021391207	anshikhajaisankar@gmail.com	<u>Anshikha</u>
9.	Prerna J. Chaudhari	7620384149	chaudhariprerna994@gmail.com	<u>Prerna</u>
10.	Hemlata D. Verma	2517058379	vermahemlata@gmail.com	<u>Hemlata</u>
11.	Shubhangi R. Nishad	9518534076	shubhinishad@gmail.com	<u>Shubhangi</u>
12.	Gayatri N. Verma	9768287591	gayatriverma06@gmail.com	<u>Gayatri</u>
13.	Komal Patle	0881748586	komalpatle@gmail.com	<u>Komal</u>
14.	Jagruhi Ranat	9265218068	Jagruhiranat@gmail.com	<u>Ranat Jagruhi</u>

Signature of:
Programme In-charge

[Signature]

IQAC Coordinator

CO ORDINATOR

INTERNAL QUALITY ASSURANCE CELL
DHARAMPETH, M. P. DEO MEMORIAL &
SCIENCE COLLEGE, NAGPUR

Principal

PRINCIPAL

Dharampeth M.P. Deo Memorial
Science College, Nagpur-440033



DHARAMPETH M. P. DEO MEMORIAL SCIENCE COLLEGE, NAGPUR
INTERNAL QUALITY ASSURANCE CELL (IQAC)

207

NEP Activity Report

Date : 18/11/22

Name of Organizing Department or Committee: Department of Chemistry

Name of the activity: NEP Activity Home science Sem III Unit III (Sem - III)

Suggested CRITERION point if any: Criteria II

Date of Activity: 15/11/22

Place of Activity: Home Science Department 2nd floor

Name of Guest Speaker/s or Judge/s or Chief Guest/s if any: Nil

Title of the Activity: Surfactant as Food Adulterant and how saponification value helps to identify food adulterant.

Number of Participants: 16

Name of the Teacher In-charge / Convener: Dr. Sandip Madhukar Bhiwagade

Names of other Committee Members / Staff: Dr. Vaishali P. Meshram

OUTCOME of the Activity with respect to mission vision of the institute and or academics:

This activity helps to understand students very clearly how surfactants use as Adulterant agents in milk and how saponification value of oil is used to identified different adulterant in given oil sample.

Activity with newspaper coverage if any : Nil

Activity data save in PC of: Department of Chemistry



Dr. Sandip M. Bhiwagade
Bhiwagade

Name & Signature of Teacher In-charge

Prof. Pitambar Humane
IQAC Coordinator

Dr. Akhilesh Peshwe
Principal

CO ORDINATOR
INTERNAL QUALITY ASSURANCE CELL
DHARAMPETH, M. P. DEO MEMORIAL &
SCIENCE COLLEGE, NAGPUR

PRINCIPAL
Dharampeth M.P. Deo Memorial
Science College, Nagpur-440133



DHARAMPETH M. P. DEO MEMORIAL SCIENCE COLLEGE,
North Ambazari Road, Near Ambazari Lake, Nagpur- 440033

DATA VALIDATION & VERIFICATION (DVV)

Name of the Programme

Interactive (Surfactant as food adulterant and how soapification value helps to identify food adulterant.

Date of the Programme

15/11/22

Name of Chief Guest if any

Name of Guest Speaker if any

Sr. No.	Name of the Participant	Mobile Number	E-mail Id	Signature
1.	Hemlata D. Varma	7517058379	varmahemlata951@gmail.com	
2.	Anshikha U. Jaiswarakar	9021391207	anshikhajaiswarakar@gmail.com	
3.	Parvati J. Chaudhari	9620384149	chaudhariparvati999@gmail.com	
4.	Astha P. Bhowray	9156003306	asthabhowray@gmail.com	
5.	Aditi R. Vaidya	9075714591	aditivaidya619@gmail.com	
6.	Ashwini N. Pandey	8308681078	ashwini.pandey@gmail.com	
7.	Minal L. Pute	7350730164	puteminal88@gmail.com	
8.	Shalu Z. Pardhi	8329115380	shalupardhi3@gmail.com	
9.	Sakshi R. Chakunde	7843018801	sakshichakunde@gmail.com	
10.	Neha R. Vishwakarma	8983534173	nehavishwakarma95285@gmail.com	
11.	Gayatri N. Varma	9763287531	gayatri.varma@gmail.com	
12.	Shubhangi R. Nishad	9519534076	shubhnishad@gmail.com	
13.	Jagriti Rawat	0265 818046	jagritirawat@gmail.com	
14.	Komal Patil	9881748596	komalpatil@gmail.com	

Signature of:

Programme In-charge

IQAC Coordinator

CO ORDINATOR

**INTERNAL QUALITY ASSURANCE CELL
DHARAMPETH, M. P. DEO MEMORIAL &
SCIENCE COLLEGE, NAGPUR**

Principal

PRINCIPAL

Dharampeth M.P. Deo Memorial
Science College, Nagpur-440033



NEP Activity Report

Date : 18/11/22.

Name of Organizing Department or Committee: Department of Chemistry

Name of the activity: NEP Activity Home science Sem III Unit IV

Suggested CRITERION point if any: Criteria II

Date of Activity: 15/11/22

Place of Activity: Home Science Department 2nd floor

Name of Guest Speaker/s or Judge/s or Chief Guest/s if any: Nil

Title of the Activity: Preparation of Phenyl

Number of Participants: 17

Name of the Teacher In-charge / Convener: Dr. Sandip Madhukar Bhiwagade

Names of other Committee Members / Staff: Dr. Vaishali P. Meshram

OUTCOME of the Activity with respect to mission vision of the institute and or academics:

This activity helps to understand students how to prepared Phenyl, what are the ingredients are used in making the Phenyl, what are the day today life application of Phenyl

Activity with newspaper coverage if any : Nil

Activity data save in PC of: Department of Chemistry



Dr. Sandip Bhiwagade.
Dr. Bhiwagade

Name & Signature of Teacher In-charge

Prof. Pitambar Humane

Prof. Pitambar Humane
IQAC Coordinator

Dr. Akhilesh Peshwe

Dr. Akhilesh Peshwe
Principal

CO ORDINATOR
INTERNAL QUALITY ASSURANCE CELL
DHARAMPETH M. P. DEO MEMORIAL &
SCIENCE COLLEGE, NAGPUR

PRINCIPAL
Dharampeth M.P. Deo Memorial
Science College, Nagpur-440033



DHARAMPETH M. P. DEO MEMORIAL SCIENCE COLLEGE,
North Ambazari Road, Near Ambazari Lake, Nagpur- 440033

DATA VALIDATION & VERIFICATION (DVV)

Name of the Programme : Preparation of Phenyl
Date of the Programme : 15/11/22
Name of Chief Guest if any : -
Name of Guest Speaker if any : -

Sr. No.	Name of the Participant	Mobile Number	E-mail Id	Signature
1.	Aditi R. Vaidya	9075714591	aditivaidya619@gmail.com	<u>Aditi</u>
2.	Astha P. Bhawra	9156003306	asthabhauray@gmail.com	<u>Astha</u>
3.	Hemlata D. Verma	7517058349	varmahemlata@gmail.com	<u>Hemlata</u>
4.	Shubhangi R. Nishad	9518534076	shubhinishad@gmail.com	<u>Shubhad</u>
5.	Prerna J. Chaudhari	7620384144	chaudhariprerna929@gmail.com	<u>Prerna</u>
6.	Anshikha U. Jaitwadekar	9021391207	anshikhajaitwadekar@gmail.com	<u>Anshikha</u>
7.	Ashwini N. Pandey	8308621072	ashwinipandey@gmail.com	<u>Ashwini</u>
8.	Minal L. Patle	7350730164	patleminal03@gmail.com	<u>Minal</u>
9.	Shalvi T. Pawdhi	8329115380	shalvipawdhi3@gmail.com	<u>Shalvi</u>
10.	SAKSHI R. CHAKURDE	7843018801	sakshichakurde@gmail.com	<u>Schakurde</u>
11.	Neha R. Vishwakarma	8083524173	nehavishwakarma55285@gmail.com	<u>Neha</u>
12.	Gayatri N. Varma	9763287531	gayatri.varma60@gmail.com	<u>Gayatri</u>
13.	Kalpi Saha gure	9579236712	kalpi@gmail.com	<u>K. Saha gure</u>
14.	Ashwini Wankhede	8767519757	awankhedeojasni@gmail.com	<u>Ashwini</u>

Signature of:
Programme In-charge
[Signature]

IQAC Coordinator
CO ORDINATOR
INTERNAL QUALITY ASSURANCE CELL
DHARAMPETH, M. P. DEO MEMORIAL &
SCIENCE COLLEGE, NAGPUR

Principal
PRINCIPAL
Dharampeth M.P. Deo Memorial
Science College, Nagpur-440033



DHARAMPETH M. P. DEO MEMORIAL SCIENCE COLLEGE, NAGPUR

INTERNAL QUALITY ASSURANCE CELL (IQAC)

Activity Report

Date: 30/11/22

Name of Organizing Department or Committee: English Department

Name of the activity: Article Writing Competition

Suggested CRITERION point if any: Criteria V

Date of Activity: 16/11/2022

Place of Activity: College

Name of Guest Speaker/s or Judge/s or Chief Guest/s if any: Nil

Title of the Activity: Article Writing Competition

Number of Participants: 10

Name of the Teacher In-charge / Convener: Dr.Mrs.Shraddha Deshpande

Names of other Committee Members / Staff: Dr.Akhilesh Peshwe (Principal)

OUTCOME of the Activity with respect to mission vision of the institute and or academics:

The article writing activity was writing a narrative type in which students were asked to give the story a different ending after the period of 20 years. Students through their imagination created stories and so they also realised that they can too write stories and get into creative writing.

Activity with newspaper coverage if any: Nil

Activity data save in PC of: English Department

Prof. Pitambar Humane
IQAC Coordinator

CO ORDINATOR
INTERNAL QUALITY ASSURANCE CELL
DHARAMPETH, M. P. DEO MEMORIAL &
SCIENCE COLLEGE, NAGPUR

Dr. Mrs. Shraddha Deshpande
Teacher Incharge

Dr. Akhilesh Peshwe
Principal
Dharampeth M.P. Deo Memorial
Science College, Nagpur.



Dharampeth M.P. Deo Memorial Science College, Nagpur
Department of English

NOTICE

Academic Session 2022-2023

ARTICLE WRITING COMPETITION



All the students are hereby informed that English Department is organizing **Article Writing Competition** on following theme:

What will happen when Ratan will meet the Postmaster after 20 years?

(Refer: The Postmaster by Rabindranath Tagore)

- Story should be original.
- Story should be in 300 words.
- Story should be in English Language only.
- Best article will be chosen for publication.
- Story should be submitted on **16th November 2022**, at 2.30 p.m in Room. No. 09.

Dr. Shraddha Deshpande
Head,
Department of English
13/10/22



DHARAMPETH M. P. DEO MEMORIAL SCIENCE COLLEGE,
North Ambazari Road, Near Ambazari Lake, Nagpur-440033

DATA VALIDATION & VERIFICATION (DVV)

Name of the Programme : Article Writing (S.E. sem-I)
Date of the Programme : 16 November 2022
Name of Chief Guest if any : _____
Name of Guest Speaker if any : _____

Sr. No.	Name of the Participant	Mobile Number	E-mail Id	Signature
1.	Gendal Bhojraj Mochde	911242728	nikhilmochde2005@gmail.com	Gendal Mochde
2	Pranali R. Dehanekar	8167581278	Pdehna@gmail.com	Pranali R.D
3	Samiksha A. Panchbudhe	9763075890	samikshapanchbudhe363@gmail.com	Samiksha Budhe
4	Prachi G. Pardhi	7263935912	prachipardhi282@gmail.com	P.G. Pardhi
5	Rutika G. Yadav	8446085943	yadavrutika454@gmail.com	Rutika
6	Jhanvi H. Lubech	8446510539	Jhanvilubech@gmail.com	Jhanvi
7	Apeksha A. Kotangale	7559455794	apekshakotangale26@gmail.com	Apeksha Kotangale
8	Ashli Meshram	7767905772	ashlimeshram202@gmail.com	Ashli
9	Ved. S. Chaudhary	7485572766	vedchaudhary.cs.769@gmail.com	Ved
10	Aman S. Karn	9028837552	karn727@gmail.com	Aman

Signature of:

Dr. Prashant Incharge
Head, Department of En-
Dharampeth M.P. Deo Memorial

IQAC Co-ordinator
Dharampeth M.P. Deo Memorial
Science College, Nagpur-440033

PRINCIPAL
Dharampeth M.P. Deo Memorial
Science College, Nagpur-440033



DHARAMPETH M. P. DEO MEMORIAL SCIENCE COLLEGE, NAGPUR
INTERNAL QUALITY ASSURANCE CELL (IQAC)
Activity Report

Date: 23/01/2023

Name of Organizing Department or Committee: English Department

Name of the activity: Pictionary Making

Suggested CRITERION point if any: Criteria V

Date of Activity: 16/11/2022

Place of Activity: College

Name of Guest Speaker/s or Judge/s or Chief Guest/s if any: Nil

Title of the Activity: Pictionary Making

Number of Participants: 10

Name of the Teacher In-charge / Convener: Dr.Mrs.Shraddha Deshpande__

Names of other Committee Members / Staff: Dr.Akhilesh Peshwe (Principal)

OUTCOME of the Activity with respect to mission vision of the institute and or academics:

Pictionary making activity was based on the objective of understanding difficult words and retaining them as a long-term memory. Images help students to understand the word better and it increases learners' vocabulary mastery.

Activity with newspaper coverage if any: Nil

Activity data save in PC of: English Department

Prof. Pitambar Humane
IQAC Coordinator
CO ORDINATOR
INTERNAL QUALITY ASSURANCE CELL
DHARAMPETH, M. P. DEO MEMORIAL &
SCIENCE COLLEGE, NAGPUR

Name & Signature of Teacher In-charge

Dr. Akhilesh Peshwe
Principal
Dharampeth M.P. Deo Memorial
Science College, Nagpur



Dharampeth M.P. Deo Memorial Science College, Nagpur

Department of English

NOTICE

Academic Session 2022-2023

PICTIONARY MAKING ACTIVITY



All the students are hereby informed that English Department is organizing **Pictionary Making Activity** on following theme:

1. The Tree Questions: Leo Tolstoy
2. The Story of an Hour: Kate Chopin
3. Mr. Know. All: W.S. Maugham
(Refer: Pearls of Wisdom)

- Pictionary should contain 10 difficult words from each chapter.
- It should include:
 - a. *Picture of the word*
 - b. *Word meaning*
 - c. *Pronunciation*
 - d. *Origin of the word*
- Pictionary's will be compiled in a booklet form.
- Pictionary should be submitted in PPT Format.
- Pictionary should be submitted on **16th November 2022**, at 2.30 p.m in Room. No. 09.

Dr. Shraddha Deshpande
Head,
Department of English
13/10/22

Dr. Shraddha Deshpande
Head, Department of English
Dharampeth M.P. Deo Memorial
Science College, Nagpur



DHARAMPETH M. P. DEO MEMORIAL SCIENCE COLLEGE,
North Ambazari Road, Near Ambazari Lake, Nagpur- 440033

DATA VALIDATION & VERIFICATION (DVV)

Name of the Programme : Pictionary (S.E. Sem-I)
Date of the Programme : 16 November 2022
Name of Chief Guest if any : _____
Name of Guest Speaker if any : _____

Sr. No.	Name of the Participant	Mobile Number	E-mail Id	Signature
1	Gendral Bhejraj Machade	911242728	nihilmachade2005@gmail.com	<u>Gendral Machade</u>
2	Pranali R. Dehankar	8767581278	Pdehna@gmail.com	<u>Pranali R. Dehankar</u>
3	Samiksha A. Panchbudhe	9763075890	samikshapanchbudhe363@gmail.com	<u>Samiksha A. Panchbudhe</u>
4	Prachi G. Pawdhi	7263935919	prachipawdhi282@gmail.com	<u>P. G. Pawdhi</u>
5	Rutika G. Yadav	8446085943	yadavrutika434@gmail.com	<u>Rutika G. Yadav</u>
6	Janvi H. Laibey	8446510539	Jhanvikribey@gmail.com	<u>Janvi H. Laibey</u>
7	Aufali Mesham	7767905772	aufalimesham2023@gmail.com	<u>Aufali Mesham</u>
8	Apeksha D. Ketangale	7559455794	apekshaketangale26@gmail.com	<u>Apeksha D. Ketangale</u>
9	Ved. S. Chaudhary	7498572766	vedchoudhary.cs749@gmail.com	<u>Ved S. Chaudhary</u>
10	Katika M. Deshmukh	9699720960	Katikamd20@gmail.com	<u>Katika M. Deshmukh</u>

Signature of:

S. D. Deshpande
Dr. S. D. Deshpande
Head Programme in Charge
Dharampeth M.P. Deo Memorial
Science College, Nagpur

[Signature]
IQAC Co-ordinator
Dharampeth M.P. Deo Memorial
Science College, Nagpur-440033

[Signature]
PRINCIPAL
Dharampeth M.P. Deo Memorial
Science College, Nagpur-440033



DHARAMPETH M. P. DEO MEMORIAL SCIENCE COLLEGE, NAGPUR
INTERNAL QUALITY ASSURANCE CELL (IQAC)

Activity Report

Date: 30/11/2022

Name of Organizing Department or Committee: Computer Science

Name of the activity: On spot Flow Chart Making Activity

Suggested CRITERION point if any: V

Date of Activity: 16/11/2022

Place of Activity: Room Number 10 (College Premises)

Name of Guest Speaker/s or Judge/s or Chief Guest/s if any: NA

Title of the Activity: On Spot Flowchart Making for enhancing learner's understanding for program flow.

Number of Participants: 54

Name of the Teacher In-charge / Convener: Mrs. Ruma Kapre

Names of other Committee Members / Staff: NA

OUTCOME of the Activity with respect to mission vision of the institute and or academics:

The activity made students familiar with the drawing of flowchart as this is the new concept they are learning on entry level. They acquired the knowledge of how to draw flowchart of the given problem. Through this activity student practiced and studied all universal symbols which are used to draw flowchart. Also they learned how to finished with given task in specified time.

Activity with newspaper coverage if any: NA

Activity data save in PC of: Mrs. Ruma Kapre



Mrs. Ruma Kapre

Name & Signature of Teacher In-charge



Prof. Pitambar Humane

IQAC Coordinator

CO ORDINATOR

INTERNAL QUALITY ASSURANCE CELL

DHARAMPETH, M. P. DEO MEMORIAL &

SCIENCE COLLEGE, NAGPUR



Dr. Akhilesh Peshwe

Principal

Principal

Dharampeth M.P. Deo Memorial
Science College, Nagpur



DHARAMPETH M. P. DEO MEMORIAL SCIENCE COLLEGE,
North Ambazari Road, Near Ambazari Lake, Nagpur- 440033

DATA VALIDATION & VERIFICATION (DVV)

Name of the Programme : Flow chart Making Activity [SEM-I: Unit I]
Date of the Programme : 16/11/2022
Name of Chief Guest if any : _____
Name of Guest Speaker if any : _____

Sr. No.	Name of the Participant	Mobile Number	E-mail Id	Signature
1.	Simran N. Dhimale	7666330683	simruandhimale80@gmail.com	<u>Dhimale</u>
2.	Ishita Deshpande	9130091540	ishitandeshpande21024@gmail.com	<u>Ishita</u>
3.	Tanu. A. Singh	8806855808	tanusingh63492@gmail.com	<u>Tanu</u>
4.	Sandhya Sahu	9730805235	nehasahu15404@gmail.com	<u>Sandhya</u>
5.	Arju Rai	9149194497	arju08@gmail.com	<u>Arju</u>
6.]	Rutika Yadav	8446085993	yadav.rutika@gmail.com	<u>Rutika</u>
7.)	Veena Borikar	9322016921	veena.borikar14@gmail.com	<u>Veena</u>
8.)	Varsha Turkar	9873650950	varshaturkar488@gmail.com	<u>Turkar</u>
9.]	Sakshi Mishra	9529889315	Smishra939683@gmail.com	<u>Sakshi</u>
10.)	Janhvi Joge	7385060871	Janhvi.Joge.09@gmail.com	<u>Janhvi</u>

Signature of:

Programme In-charge

Mrs. Ruma Kapre

IQAC Coordinator
CO ORDINATOR

INTERNAL QUALITY ASSURANCE CELL
DHARAMPETH, M. P. DEO MEMORIAL &
SCIENCE COLLEGE, NAGPUR

Principal
Principal

Dharampeth M.P. Deo Memorial
Science College, Nagpur.



DHARAMPETH M. P. DEO MEMORIAL SCIENCE COLLEGE,
North Ambazari Road, Near Ambazari Lake, Nagpur- 440033

DATA VALIDATION & VERIFICATION (DVV)

11)	Jantvi Laibey	8446510539	Jhanvilaibey@gmail.com	Jantvi
12)	Muskan Vaidya	9309773287	muskanvaidya9@gmail.com	Muskan
13)	Samiksha Shende	742088158	SamikshaShende08@gmail.com	Samiksha
14)	Sonia Niwal	7058425021	niwalsonia90@gmail.com	Sonia
15)	Monali Shende	7796516257	ShendeMonali92@gmail.com	Monali
16)	Aman Koen	9028837552	koen7817@gmail.com	Aman
17)	Badal G. Somkuwar	7448247750	BADALSOMKUWAR1@gmail.com	Badal
18)	Khushi Pali	8767607224	PaliKhushi4@gmail.com	Khushi
19)	Aayushi V. Singh	7498985604	aayushisingh5191@gmail.com	Aayushi
20)	Khushbu Pali	8459505214	paliKhushbu59@gmail.com	Khushbu
21)	Pranali Dehankar	8767581278	Pdehna@gmail.com	Pranali
22)	Nishu Kosalakar	9890996645	nishakosalkar333@gmail.com	Nishu
23)	Vaidhvee B. Gangal	7507907278	gangalvaidhvee@gmail.com	Vaidhvee
24)	Kashish K. Bisen	7887886117	kashishBisen@gmail.com	K. Bisen
25)	Preetiksha G. Barve	9579836818	Preetikshabarve54@gmail.com	Preetiksha Barve
26)	Isha Waghmare	8855919474	Ishawaghmare9474@gmail.com	Isha

Signature of:

Programme In-charge

IQAC Coordinator
CO ORDINATOR

INTERNAL QUALITY ASSURANCE CELL
DHARAMPETH, M. P. DEO MEMORIAL &
SCIENCE COLLEGE, NAGPUR

Principal
Principal
Dharampeth M.P. Deo Memorial
Science College, Nagpur.



DHARAMPETH M. P. DEO MEMORIAL SCIENCE COLLEGE,
North Ambazari Road, Near Ambazari Lake, Nagpur- 440033

DATA VALIDATION & VERIFICATION (DVV)

27.	Samiksha A. Panchbudhe	9763075890	Samiksha.panchbudhe363@gmail.com S. Panchbudhe.
28.	Janvi V. Khode	7385066634	Janvi.Khode892@gmail.com Janvi
29.	Prachi G. Pardhi	7263935912	Prachipardhi282@gmail.com Prachi
30.	Branali V. Gupta	7020069377	29991537@gmail.com Gupta
31.	Jagruti Fulkawar	8767911307	Jagrutifulkawar@gmail.com Jagruti
32.	Ved.S. Choudhary	7498572766	vedchoudhary.cs.749@gmail.com Ved
33.	Manesh D. Pawde	9112875119	Pawde manesh 97@gmail.com Manesh
34.	Priyanshu P. Singh	9527710380	Priyanshusinghji0012@gmail.com P. Singh
35.	Tejas Dongre	9322578918	Tj9874k@gmail.com Tejas
36.	Gendal B. Machode	9112142728	nilesh.machode@gmail.com Gendal
37.	Deebak Kulkarni	7061735473	Shakima Deebak K2005 Deebak Kulkarni
38.	Tushal Achare	9075995617	achare.tushal@gmail.com Tushal
39.	Aniket Bavankar	9767219209	Aniket Bavankar@gmail.com Aniket
40.	Vedant O. Unsetkar	9049932753	Unsetkar vedant@gmail.com Ved
41.	Abhishek R. Singh	8208948107	abhi0882005@gmail.com Singh

Signature of:

Programme In-charge

**IQAC Coordinator
CO ORDINATOR**

INTERNAL QUALITY ASSURANCE CELL
DHARAMPETH, M. P. DEO MEMORIAL &
SCIENCE COLLEGE, NAGPUR

Principal

Principal
Dharampeth M.P. Deo Memorial
Science College, Nagpur.



DHARAMPETH M. P. DEO MEMORIAL SCIENCE COLLEGE,
North Ambazari Road, Near Ambazari Lake, Nagpur- 440033

DATA VALIDATION & VERIFICATION (DVV)

42	Uday C. Baghele	8459549609	bagheleuday@gmail.com	Uday
43	Pratik D. Chalkh	9021640532	pratikchalkh07@gmail.com	Pratik
44	Lucky K. Navghase	9359626522	navghaselucky@gmail.com	Lucky
45	Divyani G. Zade	7972403069	divyanizade2005@gmail.com	Divya
46	Mohit Khirdkar	8055328357	mohitkhirdkar@gmail.com	Mohit
47	Divyani Zagade	9022866318	divyanizagade@gmail.com	Divya
48	Bhagashali D. Newase	7796434177	sakshinewase2017@gmail.com	B.D. Newase
49	Chetna S. Buiwle	8010342968	buiwle@ama@gmail.com	Chetna
50	Devashri P. Lokate	9021344265	lokatdevashri@gmail.com	D.P. Lokate
51	Aditi S. Jogi	9579962108	aditi.jogi2002@gmail.com	Aditi
52	Utkasha Ingale	7499159178	utkashaingale9@gmail.com	Utkasha
53	Janhvi Kibnapure	7058235243	Janhvikibnapure@gmail.com	Janhvi
54	Pradnya Tiapude	8010362232	pradnyatiapude9145@gmail.com	Pradnya

Signature of:

Programme In-charge

IQAC Coordinator

CO ORDINATOR

INTERNAL QUALITY ASSURANCE CELL
DHARAMPETH, M. P. DEO MEMORIAL &
SCIENCE COLLEGE, NAGPUR

Principal

Principal

Dharampeth M.P. Deo Memorial
Science College, Nagpur.



DHARAMPETH M. P. DEO MEMORIAL SCIENCE COLLEGE, NAGPUR
INTERNAL QUALITY ASSURANCE CELL (IQAC)

Activity Report

Date: 30/11/2022

Name of Organizing Department or Committee: Computer Science

Name of the activity: B.Sc. 1st year Quiz Competition

Suggested CRITERION point if any: Nil

Date of Activity: 17/11/2022

Place of Activity: Room No.4

Name of Guest Speaker/s or Judge/s or Chief Guest/ if any: Nil

Title of the Activity: Quiz Competition

Number of Participants: 36

Name of the Teacher In charge/Convener: Mrs. Shradhdha A. Ozarkar

Names of other Committee Members / Staff: Nil

OUTCOME of the Activity with respect to mission vision of the institute and or academics:

The objective of quiz was to evaluate the knowledge of participants within academics and develop interest in subject areas of Computer Science.

Activity with newspaper coverage if any: No

Activity data save in PC of: Yes

Note: Kindly share geotag photographs separately along with report on iqaedsc2022@gmail.com



Shradhdha
Mrs. Shradhdha A. Ozarkar
Name & Signature of Teacher In-cha

Pitambar Humane

Prof. Pitambar Humane
IQAC Coordinator

CO ORDINATOR
INTERNAL QUALITY ASSURANCE CELL
DHARAMPETH, M. P. DEO MEMORIAL &
SCIENCE COLLEGE, NAGPUR

Akhilesh Peshwe

Dr. Akhilesh Peshwe
Principal

Principal
Dharampeth M.P. Deo Memorial
Science College, Nagpur.



DHARAMPETH M. P. DEO MEMORIAL SCIENCE COLLEGE,
North Ambazari Road, Near Ambazari Lake, Nagpur- 440033

DATA VALIDATION & VERIFICATION (DVV)

Name of the Programme : Quiz Sem - I B.Sc - I
Date of the Programme : 17/11/2022 Activity
Name of Chief Guest if any : _____
Name of Guest Speaker if any : _____

Sr. No.	Name of the Participant	Mobile Number	E-mail Id	Signature
①	JANU. H. SINGH	8806955808	janusingh163492@gmail.com	
②	Simsran N. Dhimala	7666330583	simsran.dhimala80@gmail.com	
③	Rutika G. Yadav	8446085943	yadavrutika574@gmail.com	
④	Sakshi A. Mishra	9529889315	Sakshia38683@gmail.com	
⑤	Janhvi H. Laithey	84460510539	Janhvilaitey@gmail.com	
⑥	Vaishali L. Turkar	9979650950	Vaishaliturkar688@gmail.com	
⑦	Vaena V. Borikar	9522016921	vaenaborikar14@gmail.com	
⑧	Janhvi M. Joge	7385060171	JanhviJoge08@gmail.com	
⑨	Branali V. Gupta	7020069377	vg991537@gmail.com	
⑩	Pragati. Bhatnagar	8767911307	pragatibhatnagar@gmail.com	

Signature of:

Head,

Department of Computer Science
Dharampeth M. P. Deo Memorial
Science College, Nagpur

IQAC Coordinator

COORDINATOR
INTERNAL QUALITY ASSURANCE CELL
DHARAMPETH, M. P. DEO MEMORIAL
SCIENCE COLLEGE, NAGPUR

Principal

Principal
Dharampeth M.P. Deo Memorial
Science College, Nagpur.



DHARAMPETH M. P. DEO MEMORIAL SCIENCE COLLEGE,
North Ambazari Road, Near Ambazari Lake, Nagpur- 440033

DATA VALIDATION & VERIFICATION (DVV)

11	Kashish K. Aiden	9887886117	kashishkashish@gmail.com	K. Aiden
12	Chetna S. Buxite	8010942968	buxitechetna@gmail.com	Chetna
13	Manali N. Shende	7796516257	shendemanali92@gmail.com	Manali
14	Tisha Waghmare	8855919474	tishawaghmare3474@gmail.com	Tisha
15	Bhagushali D. Newase	7746434177	sakshinewase2011@gmail.com	B.D. Newase
16	Prachi G. Pardhi	9263935912	prachipardhi282@gmail.com	P.G. Pardhi
17	Kshit Khadke	8086328387	kshitkhadke@gmail.com	K. Khadke
18	Malima Klare	9545918172	malimaklare@gmail.com	M. Klare
19	Tejas Dongre	9322578918	tejas274@gmail.com	T. Dongre
20	Badal G. Somkumar	7448247750	badal.somkumar1@gmail.com	B.G. Somkumar
21	Badant O. Urethkar	9049932753	urethkarbadant@gmail.com	B.O. Urethkar
22	Arjun S. Karm	9028837552	karm287@gmail.com	A.S. Karm
23	Ved S. Chavdhary	7498522250	vedchavdhary55749@gmail.com	V.S. Chavdhary
24	Tushal Achare	9073935617	achare_tushal@gmail.com	T. Achare
25	Jasmi V. Ichode	4885066694	jasmi_khadke@gmail.com	J. Ichode
26	Samiksha A. Panchbudhe	9768075890	samikshapanchbudhe23@gmail.com	S. Panchbudhe

Signature of

Programme in-charge

Head,

Department of Computer Science
Dharampeth M. P. Deo Memorial
Science College, Nagpur

IQAC Coordinator

CO ORDINATOR
INTERNAL QUALITY ASSURANCE CELL
DHARAMPETH, M. P. DEO MEMORIAL
SCIENCE COLLEGE, NAGPUR

Principal

Dharampeth M. P. Deo Memorial
Science College, Nagpur.



DHARAMPETH M. P. DEO MEMORIAL SCIENCE COLLEGE,
North Ambazari Road, Near Ambazari Lake, Nagpur- 440033

DATA VALIDATION & VERIFICATION (DVV)

27.	Diyaani v. Zagade	9022266318	diyaanizagade@gmail.com	Bangur
28.	Jankvi A. Kishnapate	7058235243	jankvikishnapate@gmail.com	Kishnapate
29.	Pradnya Tripathi	9010362232	pradnyatripathi111@gmail.com	Tripathi
30.	Utkanha Tujale	7499159178	utkhanhatujale@gmail.com	Tujale
31.	Umesh A. Gogul	9507907278	gogulmesh@gmail.com	Gogul
32.	Devashri P. Fokde	9021941265	fokde.devashri@gmail.com	Fokde
33.	Sonia Niwal	7058425021	niwalsonia70@gmail.com	Niwal
34.	Nisha Kosurkar	9690995545	nishakosurkar373@gmail.com	Kosurkar
35.	Vidya Lohi	7020963219	vidyalohi2@gmail.com	Lohi
36.	Pronali Debnikar	8767581272	pronali@gmail.com	Debnikar

Signature of:

Head,
Department of Computer Science
Dharampeth M. P. Deo Memorial
Science College, Nagpur

CO ORDINATOR
INTERNAL QUALITY ASSURANCE CELL
DHARAMPETH, M. P. DEO MEMORIAL
SCIENCE COLLEGE, NAGPUR

Principal
Dharampeth M. P. Deo Memorial
Science College, Nagpur



Activity Report

Date: 30/11/2022

Name of Organizing Department or Committee: Computer Science
Name of the activity: B.SC 2nd Year Seminar
Suggested CRITERION point if any: Nil
Date of Activity: 17/11/2022
Place of Activity: Room No.2
Name of Guest Speaker/s or Judge/s or Chief Guest/s if any: Nil
Title of the Activity: Seminar
Number of Participants: 27
Name of the Teacher In-charge / Convener: Mrs. Shraddha A. Ozarkar
Names of other Committee Members / Staff: Nil
OUTCOME of the Activity with respect to mission vision of the institute and or academics:
The seminar provided basic knowledge of components of operating system. It also provided knowledge about how an operating system virtualises CPU and Memory. The benefits of Operating System is that it acts as interface between user and computer hardware.
Activity with newspaper coverage if any: No
Activity data save in PC of: Yes
Note: Kindly share geotag photographs separately along with report on iqacdsc2022@gmail.com

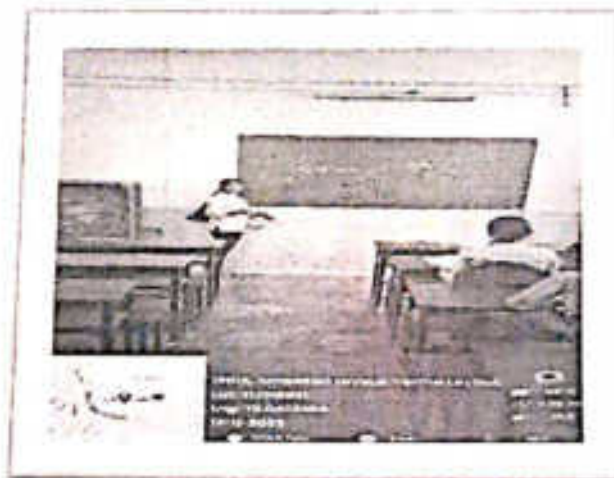

Prof. Pitambar Humane
IQAC Coordinator

CO ORDINATOR

INTERNAL QUALITY ASSURANCE CELL
DHARAMPETH, M. P. DEO MEMORIAL &
SCIENCE COLLEGE, NAGPUR

Mrs. Shraddha A. Ozarkar
Name & Signature of Teacher In-charge

Dr. Akhilesh Peshwe
Principal

Principal

Dharampeth M.P. Deo Memorial
Science College, Nagpur.



DHARAMPETH M. P. DEO MEMORIAL SCIENCE COLLEGE,
North Ambazari Road, Near Ambazari Lake, Nagpur- 440033

DATA VALIDATION & VERIFICATION (DVV)

Name of the Programme : Seminior Sem-III B.Sc - III
 Date of the Programme : 17/11/2022 Activity
 Name of Chief Guest if any : _____
 Name of Guest Speaker if any : _____

Sr. No.	Name of the Participant	Mobile Number	E-mail Id	Signature
1.	Sandhya P. Patil (State of Process)	9218079074	sandhyapatil18005@gmail.com	
2.	Bhagyashree Thakore (function of os)	8766925275	thebretbhagyashrees2003@gmail.com	
3.	Damini Katre (Deadlock)	8208255685	kat.daminitate310@gmail.com	
4.	Aditi D. Lute	7820812303	aditilute161@gmail.com	
5.	Isha S. Nemane (State of Process)	7028494761	ishanemane.72@gmail.com	
6.	Nutan Kojure (Deadlock)	8805570279	nutanekojure2@gmail.com	
7.	Nitesh G. Kawase (OAP)	7058427112	niteshkawase73@gmail.com	
8.	AKshay P. Khandaal (LC)	7350356709	AKshayKhandaal73@gmail.com	
9.	Ankuram D. Deshpande	9763824358	amrnamaji12@gmail.com	
10.	Veeshuvi Jadhav	9158919855	1170806543@gmail.com	

Signature of:
 Programme In-charge
Head,
 Department of Computer Science
 Dharampeth M. P. Deo Memorial
 Science College, Nagpur

IQAC Coordinator
CO ORDINATOR
 INTERNAL QUALITY ASSURANCE CELL
 DHARAMPETH M. P. DEO MEMORIAL &
 SCIENCE COLLEGE, NAGPUR

Principal
 Dharampeth M. P. Deo Memorial
 Science College, Nagpur.



DHARAMPETH M. P. DEO MEMORIAL SCIENCE COLLEGE,
North Ambazari Road, Near Ambazari Lake, Nagpur- 440033

DATA VALIDATION & VERIFICATION (DVV)

11.	Renuka Lamde	7719951401	renukalamsle22a	Renuka
12.	Bhagyawathi Budey	9175302601	budaybhagyawathi@	Budey
13.	Santak Jichkar	8605710878	santakjichkar@	Santak
14.	Ravi Bisen	7008810860	ravibisen06@gmail.com	Ravi
15.	Shweta Bedwal	8050440184	shwetabedwal265@gmail.com	Shweta
16.	Nitin A' Kushwaha	9693478005	nitinkushwaha206@gmail.com	Nitin
17.	Yash R. Kledekar	7020829629	yashkledkar9@gmail.com	Yash
18.	Suman P. Singh	9322018536	sumanpsingh12345678@gmail.com	Suman
19.	Mansi D. Nandanwar	7709322027	mansinandanwar1@gmail.com	Mansi
20.	Unnati C. Chopde	9022627617	unnatichopde10@gmail.com	Unnati
21.	Vicky A. Singh	9834782931	vickysingh11052001@gmail.com	Vicky
22.	Deviand S. Kaslia	7888228500	deviandev@gmail.com	Deviand
23.	Sumit S. Sahil	9302410388	sumitkumar25@gmail.com	Sumit
24.	Pratham A. Sittare	9022553289	prathamsittare@gmail.com	Pratham
25.	Rahul Kawade	9359525716	kawaderahul042@gmail.com	Rahul
26.	Khushi Waghade	9166320793	khushiwaghade6@gmail.com	Khushi Waghade

Signature of:

for Sarale
Programme In-charge

Head,

Department of Computer Science
Dharampeth M. P. Deo Memorial
Science College, Nagpur

IQAC Coordinator

CO ORDINATOR

INTERNAL QUALITY ASSURANCE CELL
DHARAMPETH, M. P. DEO MEMORIAL &
SCIENCE COLLEGE, NAGPUR

Principal

Principal

Dharampeth M.P. Deo Memorial
Science College, Nagpur



DHARAMPETH M. P. DEO MEMORIAL SCIENCE COLLEGE, NAGPUR
INTERNAL QUALITY ASSURANCE CELL (IQAC)

Activity Report

Date: 20.11.2022

Name of Organizing Department or Committee: Dept. of Home Science

Name of the activity: Pictorial Demonstration of Balancing The Plate (NEP 2022 Activity)

Suggested CRITERION point if any:

Date of Activity: 17.11.2022

Place of Activity: Classroom, Dept. of Home Science

Name of Guest Speaker/s or Judge/s or Chief Guest/s if any:

Title of the Activity: Pictorial Demonstration of Balancing The Plate

Number of Participants: 19

Name of the Teacher In-charge / Convener: Mrs. Meghna Pandit

Names of other Committee Members / Staff:

OUTCOME of the Activity with respect to mission vision of the institute and or academics:

To develop practical understanding and application of balancing the food plate and its importance.

Activity with newspaper coverage if any:

Activity data save in PC of: _____

Note: Kindly share geotag photographs separately along with report on iqaedsc2022@gmail.com

Prof. Pitambar Humane

IQAC COORDINATOR

INTERNAL QUALITY ASSURANCE CELL
DHARAMPETH, M. P. DEO MEMORIAL &
SCIENCE COLLEGE, NAGPUR

Name & Signature of Teacher In-charge
(Mrs. Meghna Pandit)

Dr. Akhilesh Peshwe

PRINCIPAL

Dharampeth M. P. Deo Memorial
Science College, Nagpur-440033





DHARAMPETH M. P. DEO MEMORIAL SCIENCE COLLEGE,
North Ambazari Road, Near Ambazari Lake, Nagpur-440033

DATA VALIDATION & VERIFICATION (DVV)

Name of the Programme

: Pictorial Demonstration of balancing the plate

Date of the Programme

: 17/11/2022

Name of Chief Guest if any

:

Name of Guest Speaker if any

:

Sr. No.	Name of the Participant	Mobile Number	E-mail Id	Signature
1.	Anshikha U. Jaiswarakar	9021391207	anshikhajaiswarakar@gmail.com	Anshikha
2.	Neha R. Vishwakarma	8983534173	neharvishwakarma2005@gmail.com	Neha
3.	SAKSHI R. CHAKUNDE	7843018801	sakshichakunde@gmail.com	Chakunde
4.	Shalu L. Pardhi	8329115380	shalupardhi@gmail.com	Shalud
5.	Minal L. Patte	9158070732	epatteminal@gmail.com	Minal
6.	prerna Chodhary.	7620384149	chaudhaniprernar34@gmail.com	Pradhari
7.	Aditi R. Vaidya	9075714591	aditivaidya613@gmail.com	Ad
8.	Bhavna A. Gusudasoni	8888437303	bhavnaagudasoni@gmail.com	Bhavna
9.	Ashwini N. Pandey	8308621072	ashwinipandey929@gmail.com	

Signature of

Programme In-charge

CO-ORDINATOR

INTERNAL QUALITY ASSURANCE CELL
DHARAMPETH, M. P. DEO M. P. DEO
SCIENCE COLLEGE, NAGPUR

PRINCIPAL

Dharampeth M. P. Deo Memorial
Science College, Nagpur-440033



Activity Report

Date: 17/11/2022

Name of Organizing Department or Committee: Department of Microbiology

Name of the activity: Internet survey on collection of information about national and international microbial culture collection center.

Suggested CRITERION point if any:

Date of Activity: 17/11/2022

Place of Activity: Department of Microbiology Dharampeth MP Deo Memorial Science College, Nagpur.

Name of Guest Speaker/s or Judge/s or Chief Guest/s if any: Nil

Title of the Activity: Collection of information about national and international microbial culture collection centre from paper II unit III for semester I students.

Number of Participants: 37students.

Name of the Teacher In-charge / Convener: Dr. Pratiksha V. Pohekar

Names of other Committee Members / Staff:

OUTCOME of the Activity with respect to mission vision of the institute and or academics:

- Students learn about the importance and activities of microbial culture collections during this internet survey and through which they get acquainted with different national and international collection centre present in the world.

Name & Signature of Teacher In-charge

Prof. Pitambar Humane

IQAC Coordinator

CO-ORDINATOR

INTERNAL QUALITY ASSURANCE CELL
DHARAMPETH M. P. DEO MEMORIAL &
SCIENCE COLLEGE, NAGPUR

Dr. Akhilesh Peshwe

Principal

Dharampeth M. P. Deo Memorial
Science College, Nagpur



DHARAMPETH M. P. DEO MEMORIAL SCIENCE COLLEGE,
North Ambazari Road, Near Ambazari Lake, Nagpur-440033

DATA VALIDATION & VERIFICATION (DWV)

Name of the Programme
Date of the Programme

Internet survey on collection of information about national
and international microbial culture collection center
: 17/11/22 (Sem I)

Name of Chief Guest if any

: Nil

Name of Guest Speaker if any

: Nil

Sr. No.	Name of the Participant	Mobile Number	Email Id	Signature
1.	Shrawani Umkar	928424534	shrawani.umkar@pimpriitson	
2.	Rematika S. Chaudhari	932223386	Komalika@chaudhari3@gmail.com	
3.	Anjali R. Thakre	766554821	Anjali.thakre381@gmail.com	
4.	Mohabirai Bhokare	9022131975	Nishabirai@bhokare@gmail.com	
5.	Pranav Y. Dautare	9699654562	pranavilautare69@gmail.com	
6.	Aakardana Y. Mairal	8030923662	akardana.y.mairal@gmail.com	
7.	Shweti Chavankar	9699823842	shwetichavankar1234@gmail.com	
8.	Pallvi K. Nayari	932608218	guybhaye17@gmail.com	
9.	Chiragji S. Gaybhaye	8329412692	guybhaye17@gmail.com	
10.	Krushik. K. Revalde	9588445994	krushikende@gmail.com	

Signature of Program In-charge

IQAC Coordinator

COORDINATOR

INTERNAL QUALITY ASSURANCE CELL
DHARAMPETH M. P. DEO MEMORIAL SCIENCE COLLEGE

Principal

Dharampeth M. P. Deo Memorial
Science College, Nagpur



DHARAMPETH M. P. DEO MEMORIAL SCIENCE COLLEGE,
North Ambazari Road, Near Ambazari Lake, Nagpur- 440033

DATA VALIDATION & VERIFICATION (DVV)

11)	Gauri Ramesh Bhojrao	8668335876	gauribhojrao34@gmail.com	Resul
12)	Krutika Pokale	9021533341	pokalekrutika6@gmail.com	Kapka
13)	Chanchal K. Waghware	7196018844	waghwanitara@gmail.com	Chanchal
14)	Heha L. Manjari	9375832266	nehamanjari93@gmail.com	Manjari
15)	Apeksha D. Kotangale	7559455794	apekshakotangale26@gmail.com	Kotangale
16)	Vaishnavi N. Jange	8421657943	Vaishnavi2004@gmail.com	Jange
17)	Katika M. Deshmukh	9699720960	Katikam20@gmail.com	Katikam
18)	Pitika S. Sondhwa	9175581655	pitikasondhwa9@gmail.com	Pitika
19)	Umang G. Warthi	9322428500	umangwarthi@gmail.com	Warthi
20)	Aufali Mesheam	8855819748	aufalimesheam2012@gmail.com	Aufali
21)	Sonali G. Chaudhari	8856055003	sonalichaudhari19@gmail.com	Sonali
22)	Anvay P. Bordekar	9165401246	anvaybordekar19@gmail.com	Anvay
23)	Riya A. Singh	9595649831	riya02007@gmail.com	Singh
24)	Shreya A. Jha	8983236002	shreyajha0303@gmail.com	Jha
25)	Malli Thaware	9960629566	thawaremali7@gmail.com	Malli

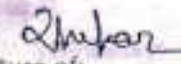
Signature of: 

INTERNAL QUALITY ASSURANCE CELL
DHARAMPETH M. P. DEO MEMORIAL &
SCIENCE COLLEGE, NAGPUR

Principal
Dharampeth M. P. Deo Memorial
Science College, Nagpur



DHARAMPETH M. P. DEO MEMORIAL SCIENCE COLLEGE,
North Ambazari Road, Near Ambazari Lake, Nagpur- 440033

DATA VALIDATION & VERIFICATION (DVV)

26)	Siddhi B. Rawai	8087143696	siddhirawai0721@gmail.com	
27)	Nitu B. Rai	7058638284	nituh1412@gmail.com	
28)	Yogita R. Denge	7058437240	yogitorlang@gmail.com	
29)	Vaideni Thote	7558499191	vaidenithote17@gmail.com	
30)	Ashwini M. Mande	8275566422	Ashwini@gmail.com	
31)	Jeet S Pardhi	7020215431	jeetspardhi11@gmail.com	
32)	Pooja B. Bisen	8762543078	poojabisen@gmail.com	
33)	Ravindra m. Khate	8007198273	khate Ravindra 992@gmail.com	
34)	Arya Dhoke	8080851619	aryanamta132@gmail.com	
35)	Aparna Mohare	7020649887	aparnamohare@gmail.com	
36)	Priyanshu Raut	9322725233	Priyanshu Raut 50@gmail.com	
37)	Anshul Kirnapure	9284007169	anshukirnapure@gmail.com	

Signature of:

Programme In-charge

IQAC Coordinator
INTERNAL QUALITY ASSURANCE CELL
DHARAMPETH M. P. DEO MEMORIAL S.
SCIENCE COLLEGE, NAGPUR

Principal
Dharampeth M. P. Deo Memorial
Science College, Nagpur



DHARAMPETH M. P. DEO MEMORIAL SCIENCE COLLEGE, NAGPUR
INTERNAL QUALITY ASSURANCE CELL (IQAC)

Activity Report

Date: 17/11/2022

Name of Organizing Department or Committee: Department of Microbiology

Name of the activity: Project on various antimicrobial activity of physical chemical agents.

Suggested CRITERION point if any:

Date of Activity: 17/11/2022

Place of Activity: Department of Microbiology Dharampeth MP Deo Memorial Science College, Nagpur.

Name of Guest Speaker/s or Judge/s or Chief Guest/s if any: Nil

Title of the Activity: Project on various antimicrobial activity of physical and chemical agent on Paper II Unit IV for semester I students.

Number of Participants: 39 students.

Name of the Teacher In-charge / Convener: Dr. Pratiksha V. Pohekar

Names of other Committee Members / Staff:

OUTCOME of the Activity with respect to mission vision of the institute and or academics:

- Project on collecting information on particular topic this activity is just like self-study, when a student explores a topic on their accord, they are actively engaging with the information.
- By this activity student can think about topics more deeply. And because students are engaged and excited about the things they are learning, they can make stronger connections between what they are learning, and remember it better.
- Students learn how to work better in groups providing their own input, listening to others, and resolving conflicts when they arise.

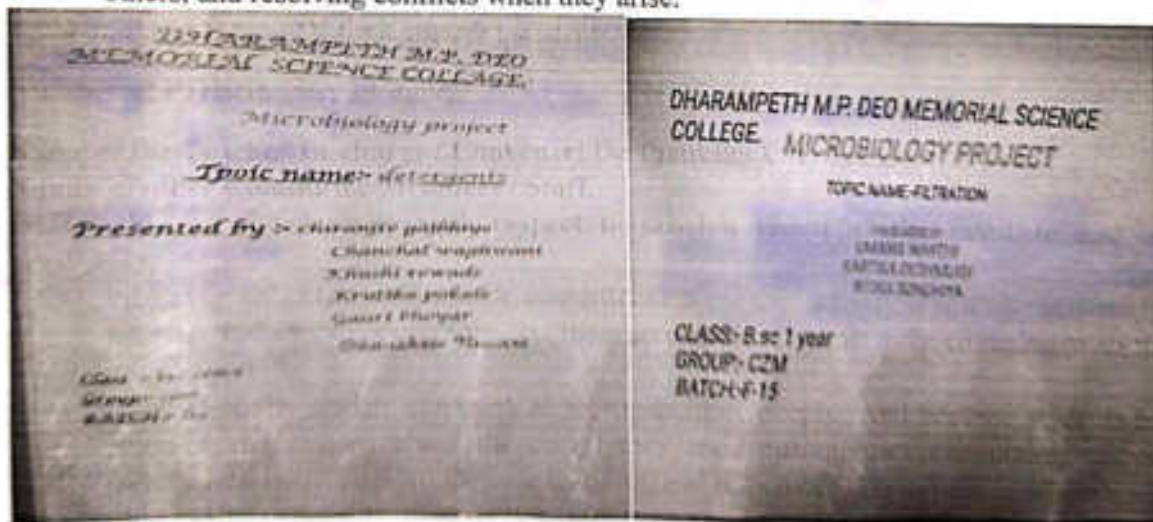

Name & Signature of Teacher In-charge

Prof. Pitambar Humane
IQAC Coordinator

Dr. Akhilesh Peshwe
Principal

INTERNAL QUALITY ASSURANCE CELL
DHARAMPETH M. P. DEO MEMORIAL SCIENCE COLLEGE, NAGPUR

Dharampeth M. P. Deo Memorial
Science College, Nagpur



DHARAMPETH M. P. DEO MEMORIAL SCIENCE COLLEGE,
North Ambazari Road, Near Embassy Lake, Nagpur-440033

DATA VALIDATION & VERIFICATION (DVV)

Name of the Programme: Project on various antimicrobial activity of Physical and chemical agents.
 Date of the Programme: 17/11/22 (Sat)
 Name of Chief Guest if any: Nil
 Name of Guest Speaker if any: Nil

Sr. Number	Name of the participant	Mobile Number	E-mail Id	Signature
1.	Komalika S. Chaudhari	9322033866	KomalikaChaudhari073@gmail.com	
2.	Anjali R. Thakur	7066554821	Anjalithakur381@gmail.com	
3.	Shamoli L. Chauri	9284249534	ShamoliChauri1912@gmail.com	
4.	Maheshwar Bhatkar	9022437915	Maheshwaribhatkar@gmail.com	
5.	Parnali Y. Chavhare	969854562	parnaliChavhare69@gmail.com	
6.	Dolly K. Nayari	9326013213	dollynayari1234@gmail.com	
7.	Khushi K. Bewade	9588445934	Khushikewade@gmail.com	
8.	Aakansha Y. maital	8010923662	aakansha1200@gmail.com	
9.	Jyoti Channekar	969923842	Jyotichannekar	
10.	Chironji V. Geybhiye	8329412094	cgeybhiye17@gmail.com	

Principal
Dharampeth M. P. Deo Memorial
Science College, Nagpur



DHARAMPETH M. P. DEO MEMORIAL SCIENCE COLLEGE,
North Ambazari Road, Near Ambazari Lake, Nagpur- 440033

DATA VALIDATION & VERIFICATION (DVV)

(11)	Geetani Ramesh Bhojra	9668335876	geetanjibhojra23@gmail.com	Geetani
(12)	Kuntika S. Pokale	9021533341	pokalekuntika@gmail.com	Kuntika
(13)	Chanchal K. Waghware	7796016894	waghwarechanchal@gmail.com	Chanchal
14)	Neha L. Wanjari	9373832266	nehawanjari733@gmail.com	Neha
15)	Apeksha D. Kotangale	7559455794	apekshakotangale26@gmail.com	Apeksha
16)	Vaishnavi V. N. Jenge	8421657943	vaishnavijenge2004@gmail.com	Vaishnavi
17)	Kalika M. Deshmukh	9649720960	Kalika.m.d.28@gmail.com	Kalika
18)	Ritika R. Sondhiya	9175581655	ritikasondhiya@gmail.com	Ritika
19)	Umang G. Wanthi	9322428500	umangwanthi@gmail.com	Umang
20)	Ajali Meshram	8855819748	ajalimeshram2022@gmail.com	Ajali
21)	Sonali Ch. Choudhary	8856055003	sonalichoudhary19@gmail.com	Sonali
22)	Anvay Borkar	914830246	anvayborkar5	Anvay
23)	Riya A. Singh	9595849831	riya.2302@gmail.com	Riya
24)	Shreya A. Jha	8983236002	Sangeeta.jha2303@gmail.com	Shreya
25)	Shikha B. Tiwari	8091149696	shikhatiwari12@gmail.com	Shikha

Signature of:

COORDINATOR
INTERNAL QUALITY ASSISTANCE CELL
DHARAMPETH M. P. DEO MEMORIAL &
SCIENCE COLLEGE, NAGPUR

Principal
Dharampeth M. P. Deo Memorial
Science College, Nagpur



DHARAMPETH M. P. DEO MEMORIAL SCIENCE COLLEGE,
North Ambazari Road, Near Ambazari Lake, Nagpur- 440033

DATA VALIDATION & VERIFICATION (DVV)

26)	Mahi. Shaware	9960629566	thawaremahif@gmail.com	Mahi
28)	Nishi B. Rai	7058638984	nishirai15@gmail.com	Nishi
29)	Muskan Kulkarni	9156887231	muskankulkarni@gmail.com	Muskan
30)	Vaidhi Thote	7558499191	vaidhitote11@gmail.com	Vaidhi
31)	Ashwini M. Nanote	8275566422	ashwini.nanote@gmail.com	Ashwini
32)	Jeet S. Pardhi	7020215431	jeetspardhi111@gmail.com	Jeet
33)	Pooja B. Bisen	8767549078	poojabisen25@gmail.com	Pooja
34)	Ravindra M. Khadse	8007198273	khadseravindra@gmail.com	Ravindra
35)	Arya Dhoke	8080851619	aryanamruti32@gmail.com	Arya
36)	Yogita Donge	70058437240	yogitadonge@gmail.com	Yogita
37)	Aparna Mohare	7020649887	aparnamohare@gmail.com	Aparna
38)	Peeyanshu Rout	9322725233	peeyanshurout5@gmail.com	Peeyanshu
39)	Anshu Kirnapure	9289067169	anshukirnapure@gmail.com	Anshu

Signature of:

Programme In-charge

IQAC Coordinator

Principal



INTERNAL QUALITY ASSURANCE CELL (IQAC)

Activity Report

Date: 17/11/2022

Name of Organizing Department or Committee: Department of Physics
Name of the activity: NEP based Demonstration Activity for B.Sc. Sem-V
Suggested CRITERION point if any: Restricted to RTMNU BSc physics syllabus.
Date of Activity: 17/11/2022
Place of Activity: Room no. 004
Name of Guest Speaker/s or Judge/s or Chief Guest/s if any: NA
Title of the Activity: Demonstration Average, RMS, MP distribution using Maxwell's concept
Activity with newspaper coverage if any: No
Number of Participants: BSc Sem-V Students - 13
Name of the Teacher In-charge / Convener: Mr. Nishant Zode
Names of other Committee Members / Staff: N.A.
OUTCOME of the Activity with respect to academics:

The students were made to learn the Analogical Average, RMS, MP distribution using Maxwell's Concept. If we were to plot the number of molecules whose velocities fall within a series of narrow ranges, we would obtain a slightly asymmetric curve known as a velocity distribution. The peak of this curve would correspond to the most probable velocity. This velocity distribution curve is known as the Maxwell-Boltzmann distribution, but is frequently referred to only by Boltzmann's name.

DVV: Enclosed.

Activity data save in PC of: Lt. Dr. P. W. Ambekar

Prof. Pitambar Humane
IQAC Coordinator

CO ORDINATOR
INTERNAL QUALITY ASSURANCE CELL
DHARAMPETH, M. P. DEO MEMORIAL &
SCIENCE COLLEGE, NAGPUR

HEAD

Name & Signature of Teacher In-charge
DEPARTMENT OF PHYSICS
Dharampeth M. P. Deo Memorial
Science College, Nagpur

Dr. Akhilesh Peshwe
Principal

Principal
Dharampeth M.P. Deo Memorial
Science College, Nagpur.



DHARAMPETH M. P. DEO MEMORIAL SCIENCE COLLEGE, NAGPUR

INTERNAL QUALITY ASSURANCE CELL (IQAC)

Activity Report

Date: 23/01/2023

Name of Organizing Department or Committee: English Department

Name of the activity: Advertisement and Publicity Handout

Suggested CRITERION point if any: Criteria V

Date of Activity: 18-11-2022

Place of Activity: college

Name of Guest Speaker/s or Judge/s or Chief Guest/s if any: Nil

Title of the Activity: Advertisement and Publicity Handout

Number of Participants: 07

Name of the Teacher In-charge / Convener: Dr.Mrs.Shraddha Deshpande

Names of other Committee Members / Staff: Dr.Akhilesh Peshwe (Principal)

OUTCOME of the Activity with respect to mission vision of the institute and or academics:

Home Science students have career opportunities in different sectors such as Health care, Entrepreneurship research, management etc. either in job or in business, they are needed to promote themselves through various mediums of advertisements. This activity helped them to design and make publicity handouts and flyers those will be needed for this endeavour.

Activity with newspaper coverage if any: Nil

Activity data save in PC of: English Department

Prof. Pitambar Humane
IQAC Coordinator

CO ORDINATOR
INTERNAL QUALITY ASSURANCE CELL
DHARAMPETH, M. P. DEO MEMORIAL &
SCIENCE COLLEGE, NAGPUR

Dr. Mrs. Shraddha Deshpande
Teacher Incharge

Dr. Akhilesh Peshwe
Principal
Dharampeth M.P. Deo Memorial
Science College, Nagpur.



Dharampeth M.P.Deo Memorial Science College, Nagpur
Department of English

NOTICE

Academic Session 2022-2023

ADVERTISEMENT AND PUBLICITY HANDOUT ACTIVITY



All the students are hereby informed that English Department is organizing **Advertisement and Publicity Handout Activity.**

Topic for Advertisement:

1. Apparel Shop
2. Bakery Shop
3. Organic Food outlet
4. Pharmacy
5. Home Décor Mall

Topic for publicity handout:

1. Save Girl Child
2. Save Electricity
3. Sound Pollution
4. Recycling of e- waste
5. No Smoking

- Submit your poster (A4 Size paper) on any one theme from each group on **18th**

November 2022 at. 11.30 a.m in Home Science Department.

Dr. Shraddha Deshpande
Head,
Department of English
13/10/22



DHARAMPETH M. P. DEO MEMORIAL SCIENCE COLLEGE,
North Ambazari Road, Near Ambazari Lake, Nagpur-440033

DATA VALIDATION & VERIFICATION (DVV)

Name of the Programme : Advertisement Design (Hic)
Date of the Programme : 18/11/2022
Name of Chief Guest if any : _____
Name of Guest Speaker if any : _____

Sr. No.	Name of the Participant	Mobile Number	E-mail Id	Signature
1.	Hemlata Dhanau Verma	9517058329	varmahemlata957@gmail.com	
2.	Shalu P. Paidhi	8329115380	shalupaidhi@gmail.com	
3.	SAKSHI R. CHAKONDE	7843018801	sakshirchakonde@gmail.com	
4.	Prema J. Chaudhari	7620384149	chaudhasiprema93@gmail.com	
5.	Minal L. Patle	7390730164	patleminal@gncil.com	
6.	Anshikha U. Jaiswarakar	9021391207	anshikhajaiswarakar@gmail.com	
7.	Shubhangi R. Nishad	9518534076	shubhnishad@gmail.com	

Signature of:

Dr. Shradha Meshpande
Programme In-charge
Department of English
Dharampeth M.P. Deo Memorial
Science College, Nagpur-440033

IQAC Coordinator
Dharampeth M.P. Deo Memorial
Science College, Nagpur-440033

Principal
Dharampeth M.P. Deo Memorial
Science College, Nagpur-440033



DHARAMPETH M. P. DEO MEMORIAL SCIENCE COLLEGE, NAGPUR
INTERNAL QUALITY ASSURANCE CELL (IQAC)

Activity Report

Date: 30/11/2022

Name of Organizing Department or Committee: Computer Science

Name of the activity: Chart Making Activity

Suggested CRITERION point if any: V

Date of Activity: 18/11/2022

Place of Activity: Room Number 10(College Premises)

Name of Guest Speaker/s or Judge/s or Chief Guest/s if any: NA

Title of the Activity: Chart Making on Key elements of Programming like control structures, Operators, Character Set.

Number of Participants: 54

Name of the Teacher In-charge / Convener: Mrs. Ruma Kapre

Names of other Committee Members / Staff: NA

OUTCOME of the Activity with respect to mission vision of the institute and or academics:

To prepare the chart on topics given to them they first studied the topics then they made groups of 4 students. Each group first discussed the layout of the chart and then on activity day they ended with the beautiful charts on the given topics. All topics are syllabus based so they also learned and got an idea of the topic from their group members.

Activity with newspaper coverage if any: NA

Activity data save in PC of: Mrs. Ruma Kapre



Prof. Pitambar Humane
IQAC Coordinator

CO ORDINATOR
INTERNAL QUALITY ASSURANCE CELL
DHARAMPETH, M. P. DEO MEMORIAL &
SCIENCE COLLEGE, NAGPUR

Mrs. Ruma Kapre
Name & Signature of Teacher In-charge

Dr. Akhilesh Peshwe
Principal

Principal
Dharampeth M.P. Deo Memorial
Science College, Nagpur.



DHARAMPETH M. P. DEO MEMORIAL SCIENCE COLLEGE,
North Ambazari Road, Near Ambazari Lake, Nagpur- 440033

DATA VALIDATION & VERIFICATION (DVV)

Name of the Programme : Chart Making Activity [SEM-I : UNIT II]
Date of the Programme : 18th November 2022
Name of Chief Guest if any : _____
Name of Guest Speaker if any : _____

Sr. No.	Name of the Participant	Mobile Number	E-mail Id	Signature
1	Ved. S. Choudhary.	7498572766	vedchoudhary.cs.749@gmail.com	
2	Sandeep Kumar.	8081144948	sandeepk27900@gmail.com	
3	Sandhya Sahu.	8730805235	mehasahu15404@gmail.com	
4	Deepak Kumar	7061735473	Shrutiadeepak12005@gmail.com	
5	Priyanshu P. Singh	9527710380	Priyanshuji Singh 0012@gmail.com	
6	Arijit S. Rai	8149194497	ariju@308@gmail.com	
7	Simran Dhimale	7666330683	Simrandhimale80@gmail.com	
8	Ishita Deshpande	9130091540	ishitadeshpande2004@gmail.com	
9	Taru Singh	8806355808	tarusingh63492@gmail.com	
10	Rahul Pandey	8767788703	rp9356521@gmail.com	

Signature of:

Programme In-charge
Mrs. Ruma Kapre

IQAC Coordinator
CO ORDINATOR
INTERNAL QUALITY ASSURANCE CELL
DHARAMPETH, M. P. DEO MEMORIAL &
SCIENCE COLLEGE, NAGPUR

Principal
Dharampeth M.P. Deo Memorial
Science College, Nagpur.



DHARAMPETH M. P. DEO MEMORIAL SCIENCE COLLEGE,
North Ambazari Road, Near Ambazari Lake, Nagpur- 440033

DATA VALIDATION & VERIFICATION (DVV)

11.	Vedant O. Umethkar	9049932753	umethkarvedant@gmail.com	Yes
12)	Tushar Achare	9075995617	achare.tushar15@gmail.com	Yes
13)	Badal G. Somkumar	7448247750	badal.somkumar18@gmail.com	Yes
14)	Tejas Dongre	9322578918	Tj,9814k@gmail.com	Yes
15)	Ritik H. Hiranwar	7488066424	RitikHiranwar37@gmail.com	Hiranwar
16)	Vibhanshu H. Tajne	9561232204	VibhanshuHtjane7@gmail.com	Vibhanshu
17)	Pratik Hiranwar	9324882413	PratikHiranwar169@gmail.com	Pratik
18)	Aman Kaur	9028837552	kaur7877@gmail.com	Yes
19)	Pratik Devidas Chalakhe	902690552	pratikchalakhe@gmail.com	Pratik Chalakhe
20)	Manu Patil	7350450573	manupatil@gmail.com	Yes
21	Vaidehi Nagarkar	9325963446	vaidehinagarkar@gmail.com	Vaidehi
22	Divyani Zade	7972403089	divyani.gade2005@gmail.com	Divyani
23)	Poochi Kusushna Graybhiye	9763765826	poochi.graybhiye@gmail.com	Poochi
24)	Pratiksha Boreve	9579836818	Pratikshaboreve9@gmail.com	Pratikshaboreve
25)	Muskan Vaidya	9309773287	muskanvaidya9@gmail.com	Muskan Vaidya
26)	Samiksha Shenolikar	7420881158	SamikshaShenolikar@gmail.com	Samiksha

Signature of:

Programme In-charge

IOAC COORDINATOR
INTERNAL QUALITY ASSURANCE CELL
DHARAMPETH, M. P. DEO MEMORIAL &
SCIENCE COLLEGE, NAGPUR

Principal
Principal
Dharampeth M.P. Deo Memorial
Science College, Nagpur.



DHARAMPETH M. P. DEO MEMORIAL SCIENCE COLLEGE,
North Ambazari Road, Near Ambazari Lake, Nagpur- 440033

DATA VALIDATION & VERIFICATION (DVV)

27)	Utkarsha . S . Ingale	7499159178	Utkarshaingale90@gmail.com <i>Utkarsha</i>
28)	Monali N. Shende	7796516257	Shendemonali72@gmail.com <i>Monali</i>
29)	prachiya B. Tiropude	5010362232	prachiyettiropude9145@gmail.com <i>Prachi</i>
30)	Soniq Niwal	7058425021	niwalsoniq70@gmail.com <i>Soniq</i>
31)	Vidya Lohi	7020963219	Vidyalohi8@gmail.com <i>Vidya</i>
32)	Nishet Kosarkar	9890996645	nishetkosarkar333@gmail.com <i>Nishet</i>
33)	vaidhvee.B.Gongal	7507907278	gongalvaidhvee@gmail.com <i>Vaidhvee</i>
34)	Pamali Dehankar	8767581278	alehna@gmail.com <i>Pamali</i>
35)	Aditi Joshi	9579962108	aditi.joshi@gmail.com <i>Aditi</i>
36)	Tanuja Yelure	9529447565	tanujayelure@gmail.com <i>T. Yelure</i>
37)	Kalyani fasetade	8626038611	kalyanifasetade3@gmail.com <i>Kalyani</i>
38)	Devashri p. Kakde	9021344265	kakdedevashri@gmail.com <i>D. P. Kakde</i>
39)	Samiksha . A . Panchbudhe	9763075890	samikshapanchbudhe3@gmail.com <i>S. Panchbudhe</i>
40)	Prachi G. Paredhi	7263935912	prachiparedhi282@gmail.com <i>P. G. P.</i>
41)	Tanvi . V . Khode	7365066634	TanviKhode892@gmail.com <i>T. Khode</i>
42)	Divya Divyani . Zagade	9022866318	Divyanizagade@gmail.com <i>Divya</i>

Signature of:

Programme In-charge

IQAC Coordinator

CO ORDINATOR

INTERNAL QUALITY ASSURANCE CELL
DHARAMPETH, M. P. DEO MEMORIAL &
SCIENCE COLLEGE, NAGPUR

Principal
Principal

Dharampeth M.P. Deo Memorial
Science College, Nagpur.



DHARAMPETH M. P. DEO MEMORIAL SCIENCE COLLEGE,
North Ambazari Road, Near Ambazari Lake, Nagpur- 440033

DATA VALIDATION & VERIFICATION (DVV)

43)	Chetna S. Burike	8010342968	burikechetna@gmail.com	Chetna
44)	Bhagyashali D. Neware	7796434177	Sakshineware2017@gmail.com	B.D. Neware
45)	Kashish K. Bisen	7887886117	kashishbisen05@gmail.com	K. Bisen
46)	Isha Waghmare	8855919474	ishawaghmare9474@gmail.com	Isha
47)	Tejus R Chamelwani	9604662119	tejuschamelwani@gmail.com	Tejus
48)	Sakshi Mishra	9529889315	Smishra39683@gmail.com	Smishra
49)	Rutika Yadav	8446085943	yadav.rutika434@gmail.com	Rutika
50)	Janhvi Jaibey	8446570539	JanhviJaibey@gmail.com	Jaibey
51)	Veena Bobrikar	9322016921	veenabobrikar14@gmail.com	Veena
52)	Varsha Turkar	9373650950	varshaturkar928@gmail.com	Varsha
53)	Janhvi Jage	7385060871	JanhviJage08@gmail.com	Janhvi
54)	Mehit Khundekar	8055328357	mehitkhundekar@gmail.com	Mehit

Signature of:

Programme In-charge

IQAC Coordinator

INTERNAL QUALITY ASSURANCE CELL
DHARAMPETH, M. P. DEO MEMORIAL &
SCIENCE COLLEGE, NAGPUR

Principal

Dharampeth M.P. Deo Memorial
Science College, Nagpur.



DHARAMPETH M. P. DEO MEMORIAL SCIENCE COLLEGE, NAGPUR
INTERNAL QUALITY ASSURANCE CELL (IQAC)

Activity Report

Date: 18/11/2022

Name of Organizing Department or Committee: Department of Microbiology

Name of the activity: Project on important product produce by microorganism.

Suggested CRITERION point if any:

Date of Activity: 18/11/2022

Place of Activity: Department of Microbiology Dharampeth MP Deo Memorial Science College, Nagpur.

Name of Guest Speaker/s or Judge/s or Chief Guest/s if any: Nil

Title of the Activity: Project on important product produce by microorganism from Paper II Unit IV for semester III students.

Number of Participants: 49 students.

Name of the Teacher In-charge / Convener: Dr. Pratiksha V. Pohekar

Names of other Committee Members / Staff:

OUTCOME of the Activity with respect to mission vision of the institute and or academics:

- Project on collecting information on particular topic this activity is just like self-study, When a student explores a topic on their accord, they are actively engaging with the information.
- By this activity student can think about topics more deeply. Because students are engaged and excited about the things they are learning, they can make stronger connections between what they are learning, and remember it better.
- Students learn how to work better in groups providing their own input, listening to others, and resolving conflicts when they arise.

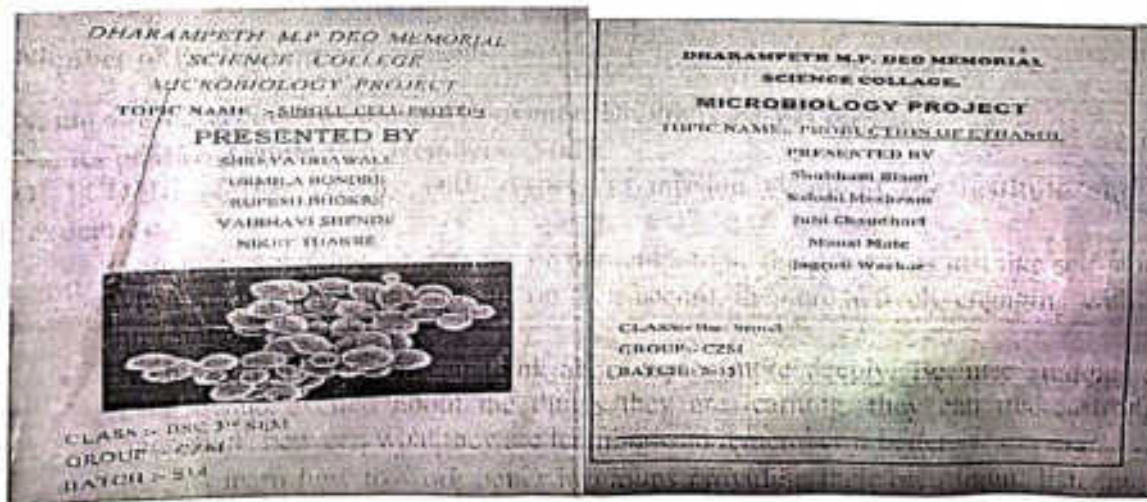

Name & Signature of Teacher In-charge

Prof. Pitambar Humane
IQAC Coordinator

Dr. Akhilesh Peshwe
Principal



DHARAMPETH M. P. DEO MEMORIAL SCIENCE COLLEGE,
North Ambazari Road, Near Ambazari Lake, Nagpur- 440033

DATA VALIDATION & VERIFICATION (DVV)

Name of the Programme : Project on important product produce by microorganism
Date of the Programme : 18/11/22 (Sum III)
Name of Chief Guest if any : Nil
Name of Guest Speaker if any : Nil

Sr. No.	Name of the Participant	Mobile Number	E-mail Id	Signature
1	Chirayu B. Dolas	8010135012	chirayudolas22@gmail.com	<u>Chirayu</u>
2	Vaibhav A. Malewar	8767838219	vaibhavmalewar19@gmail.com	<u>Vaibhav</u>
3	Siddhant H. Kulkarni	9579092937	hishantmesiddhant234@gmail.com	<u>Siddhant</u>
4	Ketaki Kerkal	9112759066	ketakikerkal13@gmail.com	<u>Ketaki</u>
5	Smriti Vaidya	8856909764	SmritiVaidya36@gmail.com	<u>Smriti</u>
6	Afina Sheikh	8080083981	afinasheikh973@gmail.com	<u>Afina</u>
7	Gauri Raut	9767873447	ankuraut2003@gmail.com	<u>Gauri</u>
8	Prachal M. Meshram	7028735508	Prachalmeshram47@gmail.com	<u>Prachal</u>
9	Kalyani Shahare	9307046378	ShahareKalyani5@gmail.com	<u>Kalyani</u>
10	Vishnvi T. Kapse	8983751089	vishnavikapse05@gmail.com	<u>Vishnvi</u>

Signature of:

Ankur
Programme In-charge

Ankur
IQAC Coordinator

Principal

M. P. Deo Memorial

Science College, Nagpur



DHARAMPETH M. P. DEO MEMORIAL SCIENCE COLLEGE,
North Ambazari Road, Near Ambazari Lake, Nagpur- 440033

DATA VALIDATION & VERIFICATION (DVV)

11.	Shital G. Bankar	7758055139	shitalbankar122@gmail.com	S.G.Bankar
12.	Anushree Chandel	9145631751	anuchandel2001@gmail.com	Anushree
13.	Surekh Longadge	8390516517	Surekhlongadge@gmail.com	Surekh
14.	Sagar S Bawane	9975460979	Sagarbawane637@gmail.com	S.Bawane
15.	Nikita .S. Bhawe	9860159628	nikitabhawe98@gmail.com	Nikita
16.	Vaishnavi Gadge	9022976449	gadgavaishnavi00@gmail.com	V.Gadge
17.	Gargi Hadge	7972076671	gargihadge@gmail.com	Gargi
18.	Harsh Kodape	9604677672	harshkodape008@gmail.com	H.Kodape
19.	Pranjal Bhojari	8010434634	Pranjalb735@gmail.com	P.Bhojari
20.	Sumit Bhandhuche	8788212339	Sumitbhandhuche100@gmail.com	S.Bhandhuche
21.	Amir Ghumde	9359236713	Amirghumde2002@gmail.com	A.Ghumde
22.	Devesh Longadge	9326246453	deveshlongadge@gmail.com	D.Longadge
23.	Aniket Kukade	7709629106	AKukade69@gmail.com	A.Kukade
24.	Vishakha Baswale	8329639834	Vishakhabaswale@gmail.com	V.Baswale
25.	Mansi Mate	8468891807	mansi1982@gmail.com	M.Mate

Signature of:

Program in-charge

IQAC Coordinator

Dharampeth M. P. Deo Memorial
Science Principal



DHARAMPETH M. P. DEO MEMORIAL SCIENCE COLLEGE,
North Ambazari Road, Near Ambazari Lake, Nagpur- 440033

DATA VALIDATION & VERIFICATION (DVV)

26	Niket Thakre	7378899087	niket.thakre82@gmail.com	N Thakre
27	Rupesh Bhokre	8805887370	bhokrerupesh@gmail.com	R Bhokre
28	Vaishnavi Nandpure	9322439316	vaishnavinandpure8@gmail.com	V Nandpure
29	Urmila V. Bhande	9370673867	bhande.urmila.2000@gmail.com	U Bhande
30	Smritya Dhande	8988264004	smrityadhande.123@gmail.com	S Dhande
31	Vaibhavi Shende	8080640782	vaibhavishende97@gmail.com	V A Shende
32	Jyoti D. Warkar	7447366023	jyotiwarkar@gmail.com	J Warkar
33	Sakshi S. Meshram	9145355733	sakshimeshram210@gmail.com	S Meshram
34	Juhi S. Chaudhari	8669248944	chaudharijuhi120@gmail.com	Juhi
37	Chhavi G. Wadikar	9325047907	chhavwadikar@gmail.com	C Wadikar
38	Pooja S. Itankar	9156973252	poojaitankar987@gmail.com	P Itankar
39	Tina G. Rahangdale	9921776769	tina.rahangdale@gmail.com	T Rahangdale
40	Twinkle G. Lokhande	7149176609	twinkalokhande@gmail.com	T Lokhande
41	Mansi . Raut	7385119931	Mansiraut491@gmail.com	M Raut
42	Vaishnavi . P. Lakhe	8669594864	chhavi.lakhe53@gmail.com	V Lakhe
43	Vaishnavi J. Bedede	865788093	vaishnavibede100@gmail.com	V Bedede

Signature of:

[Signature]
Programme In-charge

[Signature]
IQAC Coordinator

IQAC Coordinator

Dharampeth M. P. Deo Memorial Science College, Nagpur



INTERNAL QUALITY ASSURANCE CELL (IQAC)

Activity Report

Date: 18/11/2022

Name of Organizing Department or Committee: Department of Physics
Name of the activity: NEP based Demonstration Activity for B.Sc. Sem-V
Suggested CRITERION point if any: Restricted to RTMNU BSc physics syllabus.
Date of Activity: 18/11/2022
Place of Activity: Room no. 004
Name of Guest Speaker/s or Judge/s or Chief Guest/s if any: NA
Title of the Activity: Demonstration Band gap explanation in class
Activity with newspaper coverage if any: No
Number of Participants: BSc Sem-V Students - 10
Name of the Teacher In-charge / Convener: Mr. Nishant Zode
Names of other Committee Members / Staff: N.A.

OUTCOME of the Activity with respect to academics:

The band gap in semiconductor is explained by comparing it with metals and insulators. A band gap is a distance that is present between the valence band and the conduction band of electrons. Essentially, the band gap represents the minimum energy that is required to excite an electron up to a state in the conduction band where it can participate in conduction. The concept of Fermi energy is also explained.

DVV: Enclosed.

Activity data save in PC of: Lt. Dr. P. W. Ambekar

Prof. Pitambar Humane
IQAC Coordinator

CO ORDINATOR
INTERNAL QUALITY ASSURANCE CELL
DHARAMPETH, M. P. DEO MEMORIAL &
SCIENCE COLLEGE, NAGPUR

Name & Signature of Teacher In-charge
HEAD
DEPARTMENT OF PHYSICS
Dharampeth M. P. Deo Memorial
Science College, Nagpur

Dr. Akhilesh Peshwe
Principal

Principal
Dharampeth M.P. Deo Memorial
Science College, Nagpur.

209



**DHARAMPETH M. P. DEO MEMORIAL SCIENCE COLLEGE, NAGPUR
INTERNAL QUALITY ASSURANCE CELL (IQAC)**

Activity Report

Date: 30/11/22

Name of Organizing Department or Committee: Zoology

Name of the activity: one day Workshop on bee keeping and guest lecture on role of honey bee pollination in food security of India

Suggested CRITERION point if any: Criteria V

Date of Activity: 19/11/2022

Place of Activity: Botanical garden of college

Name of Guest Speaker judge/s or Chief Guest/s if any: Dr B. S. Rahile

Title of the Activity: Workshop on bee keeping and guest lecture on role of honey bee pollination in food security of India

Number of Participants: 86

Name of the Teacher In-charge / Convener: Dr. K. M. Paturkar

Names of other Committee Members / Staff: Dr. K. M. Paturkar

OUTCOME of the Activity with respect to mission vision of the institute and or academics:

Student can start rearing of honey bees at their backyard as well as in the field.

Student observes the procedure and handling of the bee hive.

Student gets knowledge of the importance of honey bees for the food security.

Activity with newspaper coverage if any: NIL.

Activity data save in PC of: Zoology Department/personal laptop



Prof. Pitambar Humane
IQAC Coordinator

COORDINATOR
INTERNAL QUALITY ASSURANCE CELL
DHARAMPETH, M. P. DEO MEMORIAL &
SCIENCE COLLEGE, NAGPUR

Dr. Kirti Paturkar

Name & Signature of Teacher In-charge

Dr. Akhlesh Peshwe
Principal

PRINCIPAL
DHARAMPETH M. P. DEO
MEMORIAL SCIENCE COLLEGE
NAGPUR

**DHARAMPETH M. P. DEO MEMORIAL SCIENCE COLLEGE,**

North Ambazari Road, Near Ambazari Lake, Nagpur- 440033

DATA VALIDATION & VERIFICATION (DVV)

Name of the Programme : One day workshop on Beekeeping and guest lecture on "Role of Honey bee pollination in food security of India"

Date of the Programme : 19/11/2022

Name of Chief Guest if any : Dr. B. S. Rahile

Name of Guest Speaker if any : Dr. B. S. Rahile

Sr.No.	Name of the Participant	Class/Semester	Mobile Number	E-mail Id	Signature	Remark
1.	Kastika Deshmukh	1st Sem	9699720962	kastikampd20@gmail.com		
2.	Umang Wanthi	1st sem	9322428500	umangwanthi@gmail.com		
3.	Mustafan Kulluwani	1st sem	9156889239	mustafankulluwani@gmail.com		
4.	Shikhi Jiwari	1st sem	8087143696	shikhijiwari2@gmail.com		
5.	Mahi Thawate	1st sem	99606201566	thawatemahi7@gmail.com		
6.	Vaidahi Thate	1st sem	7558499191	vaidahithate27@gmail.com		
7.	Priyanshu Sharma	1st sem	8080464544	priyanshu9012004@gmail.com		
8.	Yachana Pandey	1st sem	9156035297	pandeyknsr@gmail.com		
9.	Kastika Pakale	1st Sem	9021533341	pakalekastika6@gmail.com		
10.	Sefal D. Kolhe	1st Sem	8483045985	kolhesefal04@gmail.com		
11.	Kishan K. Ghughuskar	1st sem	9021231607	ghughuskarkishan2004@gmail.com		
12.	Neha L. Manjari	1st sem	9333832266	nehamanjari333@gmail.com		
13.	Shrutika Channekar	1st sem	9289628187	shrutichannekar@gmail.com		
14.	Amitesh Chavhan	3rd Sem	7382005732	amiteshchavhan25@gmail.com		

Signature of:
Programme In-charge

IQAC Co-ordinator

IQAC Co-ordinator
Dharampeth M.P. Deo Memorial
Science College, Nagpur-440033

Principal

Principal
Dharampeth M.P. Deo Memorial
Science College, Nagpur.



DHARAMPETH M. P. DEO MEMORIAL SCIENCE COLLEGE,
North Ambazari Road, Near Ambazari Lake, Nagpur- 440033

DATA VALIDATION & VERIFICATION (DVV)

Sr.No.	Name of the Participant	Class/Semester	Mobile Number	E-mail Id	Signature	Remark
1]	Gunjan I. Bhoyar	Sem I	7666799586	gunjanbhoyar@gmail.com	Gunjan	
2]	Neha. A. Waghade	Sem - V	7249895144	nehawaghade16082002@gmail.com	Neha	
3]	Mrunali. R. Sansare	Sem - V	9850163812	Sansaremrnurali1609@gmail.com	Mrunali	
4]	Chanchal. K. Waghware	Sem - I	7996016894	waghwarechanchal@gmail.com	Chanchal	
5]	Mrunal. A. Chaulkhar	Sem - I	9529014604	Mrunalchaulkhar2004@gmail.com	Mrunal	
6]	Aakamsha Y. Maisral	Sem - I	8020923662	aakumygi2004@gmail.com	Aakamsha	
7]	Khushi. K. Reubade	Sem - I	9588445994	khushireubade@gmail.com	Khushi	
8]	Devashish D. Bisen	Sem - III	7767861231	Devashishbisen31@gmail.com	Devashish	
9]	Sushma G. Guronule	Sem - III	9156238747	sushmaguronule@gmail.com	Sushma	
10]	Yashashree P. Chande	Sem - III	9764008924	yashashreechande@gmail.com	Yashashree	
11]	Gubbu R. K. Mishra	Sem - III	9860436418	Gubbumishra123@gmail.com	Gubbu	
12]	Vaishali S. Patle	Sem III	9322600647	vaishalipatle179@gmail.com	Vaishali	
13]	Ankita. R. Bhoyar	Sem - V	8788031173	ankitabhoyar@gmail.com	Ankita	
14]	Neha J. Chandratre	Sem V	9370570833	nehachandratre316@gmail.com	Neha	
15]	Arpita. T. Dakhale	Sem V	8010866758	arpitadakhale2@gmail.com	Arpita	
16]	Rakhi. P. Gedam	Sem V	7378312504	gedamrakhi2000@gmail.com	Rakhi	
17]	Rani B. Katwale	Sem V	9011247058	brani8112@gmail.com	Rani	
18]	Teet S. Pandhi	Sem I	7020215431	Teetpandhi@gmail.com	Teet	
19]	Aishwarya. A. Joshi	Sem V	7498228662	aishwaryajoshi2003@gmail.com	Aishwarya	
20]	Jagruti. A. Rawat	Sem III	9265818046	JagrutiARawat@gmail.com	Jagruti	
21]	Ashlesha Sangode	Sem III	9503998469	ashleshasangode99@gmail.com	Ashlesha	
22]	Devashish. Bisen	Sem II	8698119078	Dk Bisen 74@gmail.com	Devashish	

Signature of: 
Programme In-charge

IQAC Coordinator

IQAC Co-ordinator

Dharampeth M.P. Deo Memorial
Science College, Nagpur-440033

Principal

Principal

Dharampeth M.P. Deo Memorial
Science College, Nagpur.



DHARAMPETH M. P. DEO MEMORIAL SCIENCE COLLEGE,
North Ambazari Road, Near Ambazari Lake, Nagpur- 440033

DATA VALIDATION & VERIFICATION (DVV)

Sr.No.	Name of the Participant	Class/Semester	Mobile Number	E-mail Id	Signature	Remark
1	Prajwal S. bhayare	CZM ⁵⁻¹⁵ SEM-III	8010434634	Prajwalb738@gmail.com		
2	Tanmay Y. Chaudhari	CZM Sem V	8600102341	tchudhari8600@gmail.com	Tan	
3	Vedant Bary	CZM SEM III	8530455796	vedantbary2003@gmail.com	VBaray	
4	Gargi Hodge	CZM SEM III	7972076671	gargihodge@gmail.com	Gargi	
5	Ankita Manoj Mishra	CBZ SEM III	8421293176	mishraankita4653@gmail.com	Ankita Mishra	
6	Khushbu H. Chaudhari	CBZ SEM III	7262074960	khushbuchaudhari2@gmail.com	Kushbu	
7	Shreya S. Dhawale	CZM SEM III	8888269004	shreyadhawale14@gmail.com	Shreya	
8	Vaibhavi A. Shende	CZM SEM III	8080640782	vaibhavishende97@gmail.com	V.A. Shende	
9	Urmila V. Bhandare	CZM SEM III	9370673867	bhandareurmila2004@gmail.com	Ushende	
10	Mansi T. Mate	CZM SEM III	8469891807	mansi9182@gmail.com	Mansi	
11	Jyoti D. Wastkar	CZM SEM III	7447366023	intauti02742009@gmail.com	Jyoti	
12	Jyoti S. Chaudhari	CZM SEM III	8669248944	chaudharijyoti12@gmail.com	Jyoti	
13	Sakshi Meshram	CZM SEM III	9145355733	sakshimeshram210@gmail.com	Sakshi	
14	Arpita D. Gaydhane	CZM SEM V	9527250282	arpitagaydha@gmail.com	Arpita	
15	Karishma Bansod	CZM SEM V	7389812507	karishmabansod40@gmail.com	Karishma	
16	Janani V. Patil	CBZ SEM III	726319178	jananipatil101@gmail.com	Janani	
17	Muskan R. Yadav	CBZ SEM III	9579492617	muskanyadav6@gmail.com	Muskan	
18	Chitra D. Bhopre	CBZ SEM II	9031058104	Bhoprechitra014@gmail.com	Chitra	
19	Abhay P. Tembhare	CBZ SEM I	8175363145	abhay230102@gmail.com	Abhay	
20	Jeet S. Pawar	CZM SEM I	7020215431	jeetpawar11@gmail.com	Jeet	

Signature of:
Programme In-charge

IQAC Coordinator
IQAC Co-ordinator
Dharampeth M.P. Deo Memorial
Science College, Nagpur-440033

Principal
Principal
Dharampeth M.P. Deo Memorial
Science College, Nagpur.



DHARAMPETH M. P. DEO MEMORIAL SCIENCE COLLEGE,
North Ambazari Road, Near Ambazari Lake, Nagpur- 440033

DATA VALIDATION & VERIFICATION (DVV)

Sr.No.	Name of the Participant	Class/Semester	Mobile Number	E-mail Id	Signature	Remark
1.)	Nitika S. Das	BSc 1 st	8446297880	nitikadas994@gmail.com		
2.)	Aarushi S. Huasain	BSc 1 st	7066411418	huasain.aarushi@gmail.com		
3.)	Khushi S. Bhandi	BSc 1 st	9604362894	2005khushibhandi@gmail.com		
4.)	Aakansha K. Khobragade	BSc 1 st	7772228707	aakansha.khobragade1@gmail.com		
5.)	Khushi P. Prasad	BSc 1 st	9075669810	khushiprasad72@gmail.com		
6.)	Dhanashri Neware	BSc 1 st	9359909913	dhanashrineware18@gmail.com		
7.)	Geeta Bhatnagar	BSc 1 st	8668335876	geetabhatnagar39@gmail.com		
8.)	Rashi P. Satpute	BSc 1 st	9763941509	rashisatpute77@gmail.com		
9.)	Sabhi S. Chaudhary	BSc 1 st year	8766852462	Sabhi.chaudhary11155@gmail.com		
10.)	Dalshana S. Madani	BSc 2 nd yr	8830146576	DalshanaMadani@gmail.com		
11.)	Priyanshi N. Gaikwad	BSc 3 rd yr	9130893362	gaikwadpriyanshi34@gmail.com		
12.)	Sayali K. Pandharipande	BSc 2 nd year	9208121810	Sayali.p0959@gmail.com		
13.)	Shikha J. Yadav	BSc 3 rd year	7263881320	Shikha.yadav@gmail.com		
14.)	Vaishali K. Tiwari	BSc 3 rd year	6408097938	vaishalitiwari1612@gmail.com		
15.)	Shruti Mashram	BSc 3 rd year	8308657972	shrutimashram19@gmail.com		
16.)	Aditya Deulkar.	BSc 2 nd yr	9102891576	deulkaraditya27@gmail.com		
17.)	Nilesh Hulke.	BSc 2 nd yr	8624091652	hulkenilesh@gmail.com		

Signature of:
Programme In-charge

IQAC Co-ordinator
Dharampeth M.P. Deo Memorial
Science College, Nagpur-440033

Principal
Dharampeth M.P. Deo Memorial
Science College, Nagpur.



DHARAMPETH M. P. DEO MEMORIAL SCIENCE COLLEGE, NAGPUR
INTERNAL QUALITY ASSURANCE CELL (IQAC)

Activity Report

Date: 22nd, DEC 2022

Name of Organizing Department or Committee: BOTANY DEPARTMENT

Name of the activity: Food chain and Food Web

Suggested CRITERION point if any: CRITERION-1

Date of Activity: 19th Nov., 2022

Place of Activity: DHARAMPETH M.P. DEO MEMORIAL SCIENCE COLLEGE

Name of Guest Speaker/s or Judge/s or Chief Guest/s if any: NA

Title of the Activity: To study food chain and food web in and around college campus or residence.

Number of Participants:33

Name of the Teacher In-charge / Convener: Dr. Mrs. Reshma Hiwase

Names of other Committee Members / Staff: Dr. Chandrakumar Patle, Mr. Amol Pimpalshende, Dr. Mrs. Sweta Rai & Mrs. Dipali Nikure

OUTCOME of the Activity with respect to mission vision of the institute and or academics: Field study understand the students that the food web is natural interconnection of food chains and graphical representation of what eats what in ecological community. They both show how energy is passed in ecosystem.

Activity with newspaper coverage if any: NA

Activity data save in PC of: Botany Dep



Hiwase

Dr. Reshma Hiwase

Name & Signature of Teacher In-charge

Humane

Prof. Pitambar Humane
IQAC Coordinator

CO ORDINATOR
INTERNAL QUALITY ASSURANCE CELL
DHARAMPETH, M. P. DEO MEMORIAL &
SCIENCE COLLEGE, NAGPUR

Peshwe

Dr. Akhilesh Peshwe
Principal

Dharampeth M.P. Deo Memorial
Science College, Nagpur.



DHARAMPETH M. P. DEO MEMORIAL SCIENCE COLLEGE,
North Ambazari Road, Near Ambazari Lake, Nagpur- 440033

DATA VALIDATION & VERIFICATION (DVV)

Name of the Programme : To study food chain and food web in and
Date of the Programme : 19th Nov 2022
Name of Chief Guest if any : _____
Name of Guest Speaker if any : _____

Sr. No.	Name of the Participant	Mobile Number	E-mail Id	Signature
1.	Bhumika D. chedge	8830391103	bhumitkachedge@gmail.com	
2.	vivek R. Waghmare	88 8956482591	vivekwaghmare88@gmail.com	
3.	krushnali S. kade	8625854995	krushnali.kade67@gmail.com	
4.	Madhura U. Bhandare	8767484914	madhurabhandare@gmail.com	
5.	Neeraj Ravindra Khawarke	8766738340	neeraj2002kk@gmail.com	
6.	Ashar Shamshad Handge	9822231581	asharhandge@gmail.com	
7.	Vaishnavi Chaudhary	7249882964	vaishnavichaudhary@gmail.com	
8.	Bekrij M. Wable	9420396682	bekrijwable@gmail.com	
9.	Samiksha R. Choudhary	7517090406	choudharysamiksha26@gmail.com	
10.	Sanskriti Pauchhane	7447613185	sanskriti.pauchhane@gmail.com	

11. Sampksha N. Kundekar 9145253255 samikshakundekar@gmail.com

Signature of:

Programme In-charge

IQAC Coordinator

CO ORDINATOR
INTERNAL QUALITY ASSURANCE CELL
DHARAMPETH, M. P. DEO MEMORIAL &
SCIENCE COLLEGE, NAGPUR.

Principal
Dharampeth M.P. Deo Memorial
Science College, Nagpur.



DHARAMPETH M. P. DEO MEMORIAL SCIENCE COLLEGE,
North Ambazari Road, Near Ambazari Lake, Nagpur- 440033

DATA VALIDATION & VERIFICATION (DVV)

12	Kaustubh R. Ramteke	7218487714	ramtekekaustubh2002@gmail.com	Kaustubh
13	Shiwani P.R. Dwivedi	8855900546	shiwandwivedi41@gmail.com	Shiwani
14	Shreyansh S. Naikwar	7447844189	shreyanshnaikwar@gmail.com	Shreyansh
15	Rinam C. Wankhede	8010966520	wankhederinam07@gmail.com	Rinam
16	Sankuuti S. Panethkar	7447613185	sankuutipanethkar@gmail.com	Sankuuti
17	Ayushi Shukla	9373668043	ayushishukla2112002@gmail.com	Ayushi
18	Rakhi P. Gedum	7378312504	gedumrakhi2009@gmail.com	Rakhi
19	Rani D. Katoale	9011247032	katoalinis112@gmail.com	Rani
20	Jayashree D. Hiwase	7385473157	jshihiwase10@gmail.com	J. D. Hiwase
21	Sakshi P. Mankar	8180816539	sakshi2018mm@gmail.com	Sakshi
22	Vishakha G. Gowhade	9867670351270	vishakha2020gg@gmail.com	Vishakha
23	Attha A. Sakharwade	9405197842	atthasakharwade@gmail.com	Attha
24	Poojani C. Dandekar	9325973318	dandekarpujani6@gmail.com	Poojani
25	Avanti A. Chaphekar	7875173847	avanti1011@gmail.com	Avanti
26	Shardakshi Bhagat	7558367348	shardakshibhagat93@gmail.com	Shardakshi

Signature of:

Programme In-charge

IQAC Coordinator

CO ORDINATOR

INTERNAL QUALITY ASSURANCE CELL
DHARAMPETH, M. P. DEO MEMORIAL &
SCIENCE COLLEGE, NAGPUR

Principal

Principal

Dharampeth M.P. Deo Memorial
Science College, Nagpur.



DHARAMPETH M. P. DEO MEMORIAL SCIENCE COLLEGE, NAGPUR

**INTERNAL QUALITY ASSURANCE CELL (IQAC)
Activity Report**

Date: 19/11/2022

Name of Organizing Department or Committee: Department of Physics

Name of the activity: NEP based Demonstration Activity for B.Sc. Semester-III

Suggested CRITERION point if any: Restricted to RTMNU B.Sc. physics syllabus.

Date of Activity: 19/11/2022

Place of Activity: Room no. 003

Name of Guest Speaker/s or Judge/s or Chief Guest/s if any: NA

Title of the Activity: Demonstration on polarizer and analyser.

Activity with newspaper coverage if any: No

Number of Participants: B.Sc. Semester-III Students – 49

Name of the Teacher In-charge / Convener: Ms. Amrapali K. Meshram

Names of other Committee Members / Staff: N.A.

OUTCOME of the Activity with respect to academics:

This demonstration provided a unique opportunity to B.Sc. Semester-III students to learn the phenomenon of polarized & unpolarized light. In this activity, took two filter papers & white light torch. When torch on, got full brightness. But when filter paper put in front of torch, the intensity of light decreases. Filter paper acts like polaroid & convert unpolarized light into polarized light. This demonstration helped students to understand the concept of polariser and analyser.

DVV: Enclosed.

Activity data save in PC of: Lt. Dr. P. W. Ambekar

Prof. Pitambar Humane
IQAC Coordinator

CO ORDINATOR
INTERNAL QUALITY ASSURANCE CELL
DHARAMPETH M. P. DEO MEMORIAL &
SCIENCE COLLEGE, NAGPUR

Name & Signature of Teacher In-charge

Dr. Akhilesh Peshwe
Principal
Principal

Dharampeth M.P. Deo Memorial
Science College, Nagpur.



DHARAMPETH M. P. DEO MEMORIAL SCIENCE COLLEGE NAGPUR

Department of Physics

Class: B.Sc. Sem.- III

NEP ACTIVITY

Paper- 2

Unit- 3

Name of the Teacher: Arapali Meshram

Date: 18/11/2022

Title of Activity: Demonstration on polarisers and analyser

Sr. No.	Name of Student	Batch	Mobile No.	Email ID	Signature
1	Kajal Prabhakar Prasad	S-8	7410763137	prasadkajal2001@gmail.com	<u>Kajal Prasad</u>
2	Mansi Astok Badole	S-8	7796308467	mansiabadole@gmail.com	<u>Mansi Badole</u>
3	Kaival P. Nighat	S-8	9575250623	kaivunighat2000@gmail.com	<u>Kaival Nighat</u>
4	Jasraj D. Paliwal	S-8	9370820325	jasrajpaliwal947@gmail.com	<u>Jasraj Paliwal</u>
5	Alhanna Vinod Tangle	S-7	9022468636	alhannavinsule2000@gmail.com	<u>Alhanna Tangle</u>
6	Ritul K. Bisen	S-5	7028810840	ritulbisen06@gmail.com	<u>Ritul Bisen</u>
7	Shweta R. Bedwal	S-5	8080440184	shweta.bedwal2000@gmail.com	<u>Shweta Bedwal</u>
8	Sakshi M. Ingle	S-9	91067877694	inglesakshi703@gmail.com	<u>Sakshi Ingle</u>
9	Atharav P. Umate	S-5	9284641511	atharavumate@gmail.com	<u>Atharav Umate</u>
10	Anay H. Mishra	S-5	8103656208	anaymishra@gmail.com	<u>Anay Mishra</u>
11	Ayush R. Bhatnagar	S-5	957455092	ayushbhatnagar@gmail.com	<u>Ayush Bhatnagar</u>
12	Bhrajt Singh	1990	9570346208	bhrajtsingh1990@gmail.com	<u>Bhrajt Singh</u>
13	Bhagyashree Thakare	S-5	8766925275	thakarebhagyashree2008@gmail.com	<u>Bhagyashree Thakare</u>
14	Aditi Lute	S-5	7820812303	aditilute161@gmail.com	<u>Aditi Lute</u>
15	Nutan Sarjuse	S-5	8805570279	nutansarjuse@gmail.com	<u>Nutan Sarjuse</u>
16	Damini Katre	S-5	8208255685	damini.katre@gmail.com	<u>Damini Katre</u>
17	Mansi Sham Fading	S-8	8767154686	mansifading2110@gmail.com	<u>Mansi Fading</u>
18	Nupur Sharma	S-8	9322042259	nupursharma252@gmail.com	<u>Nupur Sharma</u>
19	Aditya Shukla	S-5	9518994638	adityashukla002@gmail.com	<u>Aditya Shukla</u>
20	Nitin Kushwaha	S-5	9693429005	nitin.kushwaha@gmail.com	<u>Nitin Kushwaha</u>
21	Divya Hanote	S-8	8605422901	divyahanote0406@gmail.com	<u>Divya Hanote</u>
22	Nupur Sharma	S-8			
23	Prachit Kotpalliwar	S-9	7498102097	prachitkotpalliwar@gmail.com	<u>Prachit Kotpalliwar</u>
24	Poojima Singh	S-9	7666939940		
25	Kavita Meshram	S-8	9657199261		<u>Kavita Meshram</u>
26	Asmin K. Sheikhan	S-3	8668323588	asmin.2029@gmail.com	<u>Asmin Sheikhan</u>
27	Priyanka S. Shah	S-3	7385197365	P53347311@gmail.com	<u>Priyanka Shah</u>
28	Apurva S. Verulkar	S-7	9623613911	apurva.verulkar@gmail.com	<u>Apurva Verulkar</u>
29	Ananya R. Mofghare	S-7	7219218955	ananya.mofghare@gmail.com	<u>Ananya Mofghare</u>

Signature of Teacher

Head of Department

- 26) Komal Patle S-8 9881748506 Komalpatle234@gmail.com Patle
- 27) Kunal Digrae S-5 8010274903 kunaldigrae@gmail.com Kungal
- 28) Prakhare Bhandare S-3 8329760853 Prakhare.Bhandare60@gmail.com Bhandare
- 29) Sanchita Patil S-5 7218079074 sanchikapatil2008@gmail.com Patil
- 30) Chetan Bopche S-4 9172484628 chetanbopche27@gmail.com Bopche
- 31) Bhumnika Thakre S-7 7218244917 BhumnikaThakre@gmail.com Bhumnika-7
- 32) Vrushali Shahare S-1 9307516332 Vrushalishahare25@gmail.com Shahare
- 33) Pawan & Vishwalekha S-3 7058608869 pawanvishwalekar286@gmail.com Pawan
- 34) Ruchika Patle S-9 8669335907 ruchikapatle4@gmail.com Patle
- 35) Swanandi Dhaen S-10 7420880982 Swanandidhaen31@gmail.com Dhaen
- 36) Ashmit Jwan S-7 8050288161 ashmitjwan@gmail.com Jwan
- 37) Ruchali D. Bhaskar S-9 9579485597 bhaskar.ruchali@gmail.com Ruchali
- 38) Omkumar D. Devangan S-5 9763624388 ommamusi12@gmail.com Devangan
- 39) Akshay P. Khondare S-5 7350956109 akshaykhondare74@gmail.com Khondare
- 40) Hitesh E. Kawase S-5 7058427112 hiteshkawase73@gmail.com Kawase
- 41) Kuntika C. Vrishna S-7 9057475751 Kumari gowalke vidya101@gmail.com Vrishna
- 42) Aditya Kumar Singh S-5 7350543901 adityasingh288180@gmail.com Aditya
- 43) Dinesh Parteli S-7 9623389676 partelidinesh51@gmail.com Parteli
- 44) Rohit Wanjari S-9 7741061907 rohit091@gmail.com Rohit
- 45) Pratik Lilhare S-9 9307489168 Pratiklilhare@gmail.com Pratik
- 46) Mithilesh Prasad S-8 7558719534 pmithilesh413@gmail.com Mithilesh
- 47) Ayaz M. Sheikh S-7 8767355503 ayaz259068@gmail.com Sheikh
- 48) Vaishu S. Nimje S-9 9579997869 vaishunimje2007@gmail.com Nimje
- 49) Vatan S. Sonwane S-9 9975410765 vatansonwane@gmail.com Sonwane

HEAD
 DEPARTMENT OF PHYSICS
 Dharampeth M. P. Deo Memorial
 Science College, Nagpur



DHARAMPETH M. P. DEO MEMORIAL SCIENCE COLLEGE, NAGPUR
INTERNAL QUALITY ASSURANCE CELL (IQAC)

Activity Report

Date: 30/11/2022

Name of Organizing Department or Committee: Home science Department

Name of the activity: Making of paper bags

Suggested CRITERION point if any:

Date of Activity: 19/11/2022

Place of Activity: Home Science Department

Name of Guest Speaker/s or Judge/s or Chief Guest/s if any:

Title of the Activity: Making of paper Bag

Number of Participants: 09

Name of the Teacher In-charge / Convener: Dr. Manda Walokar

Names of other Committee Members / Staff: HOD Manju Deshpande ma'am

OUTCOME of the Activity with respect to the mission vision of the institute and or academics:

Use paper bags instead of plastic. To raise the socio-economic status of homemakers

Activity with newspaper coverage if any:

Activity data save in PC of:

Note: Kindly share geotag photographs separately along with report on iqacdsc2022@gmail.com



[Handwritten signature]

Prof. Pitambar Humane
CO ORDINATOR
INTERNAL QUALITY ASSURANCE CELL
DHARAMPETH, M. P. DEO MEMORIAL &
SCIENCE COLLEGE, NAGPUR

Name & Signature of Teacher In-charge

[Handwritten signature: M. Walokar]

Dr. Akhilesh Peshwe

PRINCIPAL
Dharampeth M. P. Deo Memorial
Science College, Nagpur.

Cleanliness Drive/ Making of Paper Bag.
Students of sem III

19/11/22



DHARAMPETH M. P. DEO MEMORIAL SCIENCE COLLEGE,
North Ambazari Road, Near Ambazari Lake, Nagpur- 440033

DATA VALIDATION & VERIFICATION (DVV)

Sr No	Name	MOB. NO	Email	Sign
1)	Sujata Kaurse	9175451202	sujatakaurse1@gmail.com	s.kaurse
2)	Pallavi B Katre	8459277408	pkatre573@gmail.com	Pallavi
3)	ojasvi M. Wankhede	8767699751	wankhedeojasvi@gmail.com	ojasvi
4)	Pranali H. Githongadkar	9309079427	Pranali02gh@gmail.com	Pranali
5)	Vaishnavi Pradhan	9763169560	pradhanvaishnavi151@gmail.com	Pradhan
6)	Shrushti Patekar	7387067403	shrushtipatekar@gmail.com	Shrushti
7)	Bhagyashree S. Ambule	9359139068	ambuleb@gmail.com	Bhambule
8)	Tannu Konde	7841984450	kondefannu139@gmail.com	Tannu
9)	Priya K. Khawshi	9763617224	priyakhawshi3@gmail.com	Priya

Signature of:

Programme In-charge

CO-ORDINATOR
INTERNAL QUALITY ASSURANCE CELL
DHARAMPETH M. P. DEO MEMORIAL &
SCIENCE COLLEGE, NAGPUR

PRINCIPAL
Dharampeth M. P. Deo Memorial
Science College, Nagpur.



DHARAMPETH M. P. DEO MEMORIAL SCIENCE COLLEGE, NAGPUR
INTERNAL QUALITY ASSURANCE CELL (IQAC)

Activity Report

Date: 19/11/2022

Name of Organizing Department or Committee: Home Science Department

Name of the activity: Cleanliness Drive

Suggested CRITERION point if any:

Date of Activity: 19/11/2022

Place of Activity: Home Science Department

Name of Guest Speaker/s or Judge/s or Chief Guest/s if any: Dr. Manda Walokar

Title of the Activity: Cleanliness Drive for staff and students.

Number of Participants: 14

Name of the Teacher In-charge / Convener: Dr. Manda Walokar

Names of other Committee Members / Staff: HOD Manju Deshpande mam.

OUTCOME of the Activity with respect to the mission vision of the institute and or academics:

To make aware about the cleanliness of the surrounding.

A clean environment avoids all types of pollution.

Activity with newspaper coverage if any:

Activity data save in PC of:

Note: Kindly share geotag photographs separately along with report on igacdsc2022@gmail.com



Name & Signature of Teacher In-charge

M. Walokar
Manju Deshpande
Prof. Pitambar Humane
COORDINATOR
INTERNAL QUALITY ASSURANCE CELL
DHARAMPETH, M. P. DEO MEMORIAL &
SCIENCE COLLEGE, NAGPUR

Akhilesh Peshwe
Dr. Akhilesh Peshwe
Principal
Principal
Dharampeth M.P. Deo Memorial
Science College, Nagpur



DHARAMPETH M. P. DEO MEMORIAL SCIENCE COLLEGE,
North Ambazari Road, Near Ambazari Lake, Nagpur- 440033

DATA VALIDATION & VERIFICATION (DVV)

Name of the Programme : Cleanliness Drive
Date of the Programme : 19/11/22
Name of Chief Guest if any : _____
Name of Guest Speaker if any : _____

Sr. No.	Name of the Participant	Mobile Number	E-mail Id	Signature
1)	Bhagyashree S Ambule	9359139068	ambuleb667@gmail.com	<u>Ambule</u>
2)	Pranali H. Ghengardkar	9309079427	pranu02yhg@gmail.com	<u>Bancudkar</u>
3)	Pallavi B. Patre	8459277408	pkatre573@gmail.com	<u>Patre</u>
4)	Varishnavi K. Prudhan	4763169560	varishnavi.k.1556@gmail.com	<u>Prudhan</u>
5)	Shrushti Patekar	7387067403	shrushtipatekar@gmail.com	<u>Patekar</u>
6)	Sujata V. Kaurte	9175451202	sujatatakar@gmail.com	<u>Kaurte</u>
7)	Avani S. Shenwai	9096507459	avanishenwais@gmail.com	<u>Shenwai</u>
8)	Ojasvi M. Wankhede	8767699751	wankhedeojasvi@gmail.com	<u>Wankhede</u>
9)	Tannu S. Konde	7841984450	kondetannu33@gmail.com	<u>Konde</u>
10)	Kimaya N. Kale	8866073742	kimaya.kale003@gmail.com	<u>Kimaya</u>

Signature of: Pritya K. Khawshi

Pritya K. Khawshi
Programme In-charge

Pritya K. Khawshi
COORDINATOR
INTERNAL QUALITY ASSURANCE CELL
DHARAMPETH, M. P. DEO MEMORIAL SCIENCE COLLEGE

Pritya K. Khawshi
Principal
Dharampeth M.P. Deo Memorial
Science College, Nagpur.

DHARAMPETH M P DEO MEMORIAL SCIENCE COLLEGE

DEPARTMENT OF HOME SCIENCE

NOTICE

Students of BHSc (sem I /II/III/IV/V/VI) are informed that cleanliness drive activity (lecture visit, workshop, guest lecture, method demonstration.) will be conducted on an online/offline mode dated on ----- Attendance is compulsory.

Time: 2.00 PM

Venue: Department of Home Science

MS Galokar

Name of Teacher Incharge

W. B. Patil
Head of the Department
Head, Department of Home Science
(Department of Home Science)
Science College, Nagpur



DHARAMPETH M. P. DEO MEMORIAL SCIENCE COLLEGE, NAGPUR
INTERNAL QUALITY ASSURANCE CELL (IQAC)

Activity Report

Date: 30/11/2022

Name of Organizing Department or Committee: Home Science Department.

Name of the activity: Public Speaking

Suggested CRITERION point if any:

Date of Activity: 19/11/2022

Place of Activity: Home Science department

Name of Guest Speaker/s or Judge/s or Chief Guest/s if any:

Title of the Activity: Public Speaking

Number of Participants: 08

Name of the Teacher In-charge / Convener: Dr. Manda Walokar

Names of other Committee Members / Staff: HOD Manju Deshpande Mam

OUTCOME of the Activity with respect to the mission vision of the institute and or academics: To develop confidence in students. Aware of a social cause.

Activity with newspaper coverage if any:

Activity data save in PC of:

Note: Kindly share geotag photographs separately along with report on igacdsc2022@gmail.com



CO ORDINATOR
Prof. Pitambar Humane
INTERNAL QUALITY ASSURANCE CELL
DHARAMPETH, M. P. DEO MEMORIAL &
SCIENCE COLLEGE, NAGPUR

Name & Signature of Teacher In-charge

Dr. Akhilesh Peshwe
Principal

Principal
Dharampeth M.P. Deo Memorial
Science College, Nagpur.

practice of public speaking
Students of sem III

19/11/22



DHARAMPETH M. P. DEO MEMORIAL SCIENCE COLLEGE,
North Ambazari Road, Near Ambazari Lake, Nagpur- 440033

DATA VALIDATION & VERIFICATION (DVV)

Sl.NO	Name	Mobile No.	Email NO	Sign.
1.	Bujata Vasant Kaware	9175451202	suvedakaware@gmail.com	BKaware
2.	Bhagyashree S. Ambule	9359139068	ambule.b667@gmail.com	B Ambuly
3.	Pranav H. Ghoralkar	9309079427	Pranav02gh@gmail.com	Pranav
4.	Vaishnavi R. Pradhan	9763169560	pradhanvaishnavi15@gmail.com	Vaishnavi
5.	Shrushti Patilkar	7387067403	shrushti.patilkar@gmail.com	Shrushti
6.	Tannu S. Korde	7841984450	korditannu13@gmail.com	Tannu
7.	Priya K. Khawshi	9763617224	Priyakhawshi@gmail.com	Priya
8.	Osavi M. Wankhede	8767699757	wankhedeosavi@gmail.com	Osavi

Signature of:

M. Swalokar
Programme In-charge

COORDINATOR
INTERNAL QUALITY ASSURANCE CELL
DHARAMPETH M. P. DEO MEMORIAL &
SCIENCE COLLEGE, NAGPUR

Principal
Dharampeth M. P. Deo Memorial
Science College, Nagpur.

DHARAMPETH M P DEO MEMORIAL SCIENCE COLLEGE

DEPARTMENT OF HOME SCIENCE

NOTICE

Students of BHSc (sem I /II/III/IV/V/VI) are informed that Public Speaking activity (lecture visit, workshop, guest lecture, method demonstration.) will be conducted on an online/offline mode dated on 19/11/2022. Attendance is compulsory.

Time: 1.00 pm

Venue: Department

M. S. S. S. S.
Name of Teacher Incharge

H. S. S. S.
Head of the Department
Head, Department of Home Science
(Department of Home Science)
Science College, Nagpur



DHARAMPETH M. P. DEO MEMORIAL SCIENCE COLLEGE, NAGPUR
DEPARTMENT OF COMPUTER SCIENCE
ACADEMIC SESSION: 2022-23

NOTICE

15th November 2022

All the students of B.Sc.[SEM III] are hereby informed that the Department of Computer Science, Dharampeth M.P.Deo Memorial Science College, Nagpur is going to organize Group Discussion Activity on the Topic base on Unit I of Paper I[Data Structures] on 19th November 2022. All the students must remain present and participate in this activity.

Venue: Room No. 04
Time: 1.00pm

PRINCIPAL
DHARAMPETH M. P. DEO
MEMORIAL SCIENCE COLLEGE
NAGPUR

Head, Department of Computer Science
Head,
Department of Computer Science
Dharampeth M. P. Deo Memorial
Science College, Nagpur



DIHARAMPETH M. P. DEO MEMORIAL SCIENCE COLLEGE, NAGPUR
INTERNAL QUALITY ASSURANCE CELL (IQAC)

Activity Report

Date: 30th November 2022

Name of Organizing Department or Committee: Computer Science Department
 Name of the activity: Group Discussion
 Suggested CRITERION point if any: Criteria II, V
 Date of Activity: 19th November 2022
 Place of Activity: Room No.04
 Name of Guest Speaker/s or Judge/s or Chief Guest/s if any: Nil
 Title of the Activity: Group Discussion on Linked List for B.Sc. Sem III Paper I [Unit I]
 Number of Participants: 24
 Name of the Teacher In-charge / Convener: Dr.Mrs.Snehal Narale
 Names of other Committee Members / Staff: Nil
OUTCOME of the Activity with respect to mission vision of the institute and or academics:

The Objectives of Group discussion was

- Data collection
- Breeding fresh ideas and taking inputs from a particular group.
- Perception of student participants on a particular topic.
- Identify a solution to a specific problem or issue.

Group Discussion (GD) is a method of learning where students discuss issues and ideas together. In GD, students will be able to :

- Work in groups to solve problems on the topic and learn from each other.
- It helps students develop their critical thinking skills ,listening and speaking skills, problem-solving abilities, and communication skills.
- Promote a deeper understanding of a topic and increase long-term retention.
- GD's can also help increase participants' attention and help maintain their focus by involving them in the learning process.
- Participants get a chance to share their experiences and defend their opinions.
- It also promotes the students to enhance their confidence level.
- It is an effective tool in problem solving, decision making and personality assessment.

Activity with newspaper coverage if any: Nil

Activity data save in PC of: Dr. Mrs. Snehal Narale's Laptop



[Signature]

CO ORDINATOR

INTERNAL QUALITY ASSURANCE CELL
 DIHARAMPETH M. P. DEO MEMORIAL &
 SCIENCE COLLEGE, NAGPUR

[Signature]
 Dr.Mrs.Snehal Narale

Name &Signature of Teacher In-charge

[Signature]

Principal
 Dr.Akhil Deshpande
 Dharampeth M.P. Deo Memorial
 Science College, Nagpur.



DHARAMPETH M. P. DEO MEMORIAL SCIENCE COLLEGE,
North Ambazari Road, Near Ambazari Lake, Nagpur- 460033

DATA VALIDATION & VERIFICATION (DVV)

Name of the Programme : Group discussion on Linked List [Sem III]
 Date of the Programme : 19/11/2022
 Name of Chief Guest if any : _____
 Name of Guest Speaker if any : _____

Sr. No.	Name of the Participant	Mobile Number	E-mail Id	Signature
	<u>Group 1</u>			
1	<u>Khushboo G. Walmik</u>	<u>8983700782</u>	<u>khushboowalmik1@gmail.com</u>	<u>[Signature]</u>
2	<u>Yamini A. Mishra</u>	<u>9623040668</u>	<u>yaminimishra225@gmail.com</u>	<u>[Signature]</u>
3	<u>Isha S. Nemade</u>	<u>7028494761</u>	<u>ishanemade72@gmail.com</u>	<u>[Signature]</u>
4	<u>Harshal N. Jankar</u>	<u>9527732348</u>	<u>harshaljankar8@gmail.com</u>	<u>[Signature]</u>
	<u>Group 2</u>			
5	<u>Sadhana M. Pandhi</u>	<u>7276017322</u>	<u>sadhana.pandhi1@gmail.com</u>	<u>[Signature]</u>
6	<u>Bhagyawathi . R. Pandey</u>	<u>9175302601</u>	<u>pandeybhagyawathi@gmail.com</u>	<u>[Signature]</u>
7	<u>Unnati . C. Chopde</u>	<u>9022677617</u>	<u>unnatichopde07@gmail.com</u>	<u>[Signature]</u>
8	<u>Mansi . D. Nandawale</u>	<u>7709322027</u>	<u>mansinandawale1@gmail.com</u>	<u>[Signature]</u>

Signature of:

 Program In-charge
 Department of Computer Science
 Dharampeth M. P. Deo Memorial

CO ORDINATOR
 INTERNAL QUALITY ASSURANCE CELL
 DEPARTMENT OF COMPUTER SCIENCE
 DHARAMPETH M. P. DEO MEMORIAL & SCIENCE COLLEGE, NAGPUR

Principal
 Dharampeth M. P. Deo Memorial
 Science College, Nagpur.



DHARAMPETH M. P. DEO MEMORIAL SCIENCE COLLEGE,
North Ambazari Road, Near Ambazari Lake, Nagpur-440033

DATA VALIDATION & VERIFICATION (DVV)

Group 3				
9	Nutan Surjuse	8805570277	nutansurjuse2@gmail.com	Nutan
10	Aditi Kute	7820812303	aditilute161@gmail.com	Aditi
11	Damini Katre	8208255685	damini.katre7@gmail.com	Damini
12	Sanjita Patil	9218099074	sanjita.patil2002@gmail.com	Sanjita
Group 4				
13	Saurav K. P. Ukey	9356088871	sauravukkey6@gmail.com	Saurav
14	Yash R. K. Kadekar	7020929622	yashkadekar5@gmail.com	Yash
15	Anush G. Gawade	808004076	agawade5602@gmail.com	Anush
16	Rahul R. Kawade	9359525716	kawaderahul042@gmail.com	Rahul
Group 5				
17	Nitin K. Kushewala	9609429005	nitinkushewala706@gmail.com	Nitin
18	Anuj H. Mishra	8103656208	anujmishra251202@gmail.com	Anuj
19	Aditya Kumar Suryabansh Singh	7350543901	adityaugh28818@gmail.com	Aditya
20	Hitesh Ganesh Kawade	7058427112	hitesh.kawade73@gmail.com	Hitesh

Signature of:

Programme of Computer Science
Dharampeth M. P. Deo Memorial
Science College, Nagpur

COORDINATOR
INTERNAL QUALITY ASSURANCE CELL
DHARAMPETH M. P. DEO MEMORIAL
SCIENCE COLLEGE, NAGPUR

Principal
Dharampeth M. P. Deo Memorial
Science College, Nagpur.



DHARAMPETH M. P. DEO MEMORIAL SCIENCE COLLEGE, NAGPUR
INTERNAL QUALITY ASSURANCE CELL (IQAC)

Activity Report

Date: 30/11/2022

Name of Organizing Department or Committee: IQAC Initiative with Innovation and Incubation Cell

Name of the activity: Workshop cum Training Program

Suggested CRITERION point if any: V

Date of Activity: 21/11/2022

Place of Activity: Late Vinayakrao Phatak Hall

Name of Guest Speaker/s or Judge/s or Chief Guest/s if any: Dr. Rahul Pethe, G. H. Raisoni Institute of Engineering and Technology, Nagpur

Title of the Activity: Demonstration of some innovative projects and conversion of idea into projects.

Number of Participants: 64

Name of the Teacher In-charge / Convener: Lt. Dr. Prashant Ambekar, Mrs. Ruma Kapre

Names of other Committee Members / Staff: NA

OUTCOME of the Activity with respect to mission vision of the institute and or academics:

Through the Training Program/ Workshop students observed various demonstration on innovation ideas. How to prepare basic circuits of any model, how to programmed initially using which language etc. The speaker gave live demonstration of Drone and some other models which was developed by their students. He appealed to students try to convert ideas into projects and also motivated them for doing projects so that they can enhance their knowledge.

Activity with newspaper coverage if any: NA

Activity data save in PC of: Mrs. Ruma Kapre



Prof. Pitambar Humane
IQAC Coordinator
COORDINATOR
INTERNAL QUALITY ASSURANCE CELL
DHARAMPETH, M. P. DEO MEMORIAL &
SCIENCE COLLEGE, NAGPUR

Lt. Dr. Prashant Ambekar
Mrs. Ruma Kapre
Name & Signature of Teacher In-charge

Dr. Akhilesh Peshwe
Principal
Principal
Dharampeth M.P. Deo Memorial
Science College, Nagpur



DHARAMPETH M. P. DEO MEMORIAL SCIENCE COLLEGE,
North Ambazari Road, Near Ambazari Lake, Nagpur- 440033

DATA VALIDATION & VERIFICATION (DVV)

Name of the Programme : Workshop cum Training Program
Date of the Programme : 21/11/2022
Name of Chief Guest if any : Dr. Rahul Pethe, G. H. Raisoni Institute of Engineering and Technology, Nagpur.
Name of Guest Speaker if any : _____

Sr. No.	Name of the Participant	Mobile Number	E-mail Id	Signature
01	Sagat Omprakash Sonwane	9356591564	Sagatsonwane706@gmail.com	
02	Pratiksha S. Umare	9359175006	pratikshaumare5@gmail.com	
03	Ravni. D. Kakate	7498945148	raunikakate@gmail.com	
04	Megha T. Bisen	7517953260	bisen7652@gmail.com	
05	Ankita. L. Sonwane	9516 9579661554	ankitalsonwane10@gmail.com	
06	Kiran R. Waghade	9325845366	KiranR.Waghade@gmail.com	
07	Sonija Chavhan	9764386444	Svchaniya@gmail.com	
08	Sakshi. Hiwarkar	9356651344	sakshihiwarkar193@gmail.com	
09	Seema Lakda	7058728070	Seemalakda023@gmail.com	
10	Samiksha R. Khasare	9604473539	sakhasare@gmail.com	

Signature of:

Programme In-charge

Mrs. Ruma Kapre

COORDINATOR

INTERNAL QUALITY ASSURANCE CELL
DHARAMPETH, M. P. DEO MEMORIAL &
SCIENCE COLLEGE, NAGPUR.

Principal

Dharampeth M.P. Deo Memorial
Science College, Nagpur.



DHARAMPETH M. P. DEO MEMORIAL SCIENCE COLLEGE,
North Ambazari Road, Near Ambazari Lake, Nagpur- 440033

DATA VALIDATION & VERIFICATION (DVV)

11.	Mu. Sujata. Phorraj. Sonwane	9021135140	sujatasonwane2001@gmail.com	<u>Sujata</u>
12.	Priyanshi . P. Singh	7219259020	priyanshisingh18040@gmail.com	<u>Singh</u>
13.	Pragya R. Jha	9665852975	pragya697@gmail.com	<u>Jha</u>
14.	Anushka . S. Das	7058933157	ad04092001@gmail.com	<u>Das</u>
15.	Chaitali .M. Buxbade	9359540524	chaitali2020b@gmail.com	<u>Chaitali</u>
16.	Raksha D. Dhote	7498511875	raakshadhote3@gmail.com	<u>Dhote</u>
17.	Shruti A. Kukde	9075232517	Shrutikukde13@gmail.com	<u>S. Kukde</u>
18.	Pallavi y. Bhagat	9022654940	Pallavim2208@gmail.com	<u>Bhagat</u>
19.	Beachi K. Vasabhe	9325336932	BeachiVasabhe@gmail.com	<u>Vasabhe</u>
20.	Sakshi Moon	7745827736	sakshim3030@gmail.com	<u>Moon</u>
21.	MUSKAN Sheikh	8055474633	muskan2019555@gmail.com	<u>Sheikh</u>
22.	Shivani Bhute	9302900209	bhuteshivani895@gmail.com	<u>Bhute</u>
23.	Nikita Ekre	7972190515	ekrenikita344@gmail.com	<u>Ekre</u>
24.	Raji . N. Patthan	8669595198	Rajikhanec66@gmail.com	<u>R. Patthan</u>
25.	Priyanshu B. Singh	7775800561	singhpriyanshu0784@gmail.com	<u>Singh</u>
26.	Vishal Kumar Singh	9610187223	singhvishal96a@gmail.com	<u>Vishal</u>

Signature of:

Programme In-charge

CO ORDINATOR -
INTERNAL QUALITY ASSURANCE CELL
DHARAMPETH M. P. DEO MEMORIAL &
SCIENCE COLLEGE, NAGPUR

Principal
Dharampeth M. P. Deo Memorial
Science College, Nagpur.



DHARAMPETH M. P. DEO MEMORIAL SCIENCE COLLEGE,
North Ambazari Road, Near Ambazari Lake, Nagpur- 440033

DATA VALIDATION & VERIFICATION (DVV)

27.	Tanmay Bhute	7697250831	tanmay bhute 500@gmail.com	Tanmay
28	Shivam S. Mawrya	9607873702	Shivammawrya123@gmail.com	Shivam
29.	Sahil R. Jivtode	9373414643	sahiljivtode73@gmail.com	Sahil
30.	AKASH A. SIKDAR	9175422051	sikdarakash15@gmail.com	Akash
31.	Diya R. Patil	7757052463	diyapatil553@gmail.com	Diya
32.	Pranjal D. Sarudkar	7385458510	Pranjalsarudkar1234@gmail.com	Pranjal
33	Rishikesh R. Detha	8788199260	rishikeshdetha2002@gmail.com	Rishi
34	Mitraj R. Chauhan	9420626335	mitrajrajchauhan7182@gmail.com	Mitraj
35	Pranay S. Dhore	8830624265	pranaydhore97@gmail.com	Pranay
36	Sakshi L. Barapatre	8317219372	sakshi2002bb@gmail.com	Sakshi
37	Vaibhav S. Rane	7744951383	vaibhavrane@gmail.com	Vaibhav
38]	Prachi S. Manusmare	9856969609	prachi2020m@gmail.com	Prachi
39]	Saurabh Sharma	9130964601	Saurabhsharma1069@gmail.com	Saurabh
40]	Piyush Kapse	9373563027	Kapsepiyush03@gmail.com	Piyush
41)	Pratiksha S. Thakre	8459570299	Pratikshathakre1109@gmail.com	Pratiksha
42)	Divyanshu V. Shule	7030731921	divyanshushule2002@gmail.com	Divyanshu

Signature of:

[Signature]

Programme In-charge

COORDINATOR
INTERNAL QUALITY ASSURANCE CELL
DHARAMPETH M. P. DEO MEMORIAL &
SCIENCE COLLEGE, NAGPUR

[Signature]
Principal
Dharampeth M. P. Deo Memorial
Science College, Nagpur.



DHARAMPETH M. P. DEO MEMORIAL SCIENCE COLLEGE,
North Ambazari Road, Near Ambazari Lake, Nagpur- 440033

DATA VALIDATION & VERIFICATION (DVV)

43	Uday P. Khandarkar	9545897196	udaykhandarkar19@gmail.com	<u>Kandarkar</u>
44	Himanshu R. Lakhe	7448252469	himanshulakhe199@gmail.com	<u>Lakhe</u>
45	Sumeet S. Bhalekar	9021627757	sumitbhalekar162@gmail.com	<u>S. Bhalekar</u>
46	Abhishek A. Falke	7823835535	abhishekfalke2002@gmail.com	<u>Falke</u>
47	Abdul Rahe Aman Stratique	7666938578	raheaman2011@gmail.com	<u>Stratique</u>
48	Pratik D. Sagle	7057931570	pratikdsagle92@gmail.com	<u>Sagle</u>
49	Abhijeet Manekar	8758029642	abhijeetmanekar5@gmail.com	<u>Manekar</u>
50	Mukesh Desai	7249339368	Desaim64@gmail.com	<u>Mukesh</u>
51	Pratham P. Gupta	8767275149	Prathamgupta11@gmail.com	<u>Gupta</u>
52	Akash D. Das	7972942799	akashdadas@gmail.com	<u>Das</u>
53	Sanchit Joshi	8975706788	sanchitjoshi03@gmail.com	<u>Joshi</u>
54	Bhavesh R. Maske	7489951631	bhaveshmaske2002@gmail.com	<u>Bhavesh M.</u>
55	Tanmay S. Gadam	7262034396	tanmaygadams1@gmail.com	<u>T.S. Gadam</u>
56	Pranav S. Mahajan	7385551492	pranavmahajan43@gmail.com	<u>Mahajan</u>
57	Mukul D. Hood	9604785822	mukundhood2002@gmail.com	<u>Hood</u>
58	Rajit Rohad	9175635273	Rajitrohad21@gmail.com	<u>Rohad</u>
59	Mahesh P. Maske	9021951173	maheshmaske2@gmail.com	<u>Maske</u>

Signature of:

Prave

Programme In-charge

Prave
CO ORDINATOR

INTERNAL QUALITY ASSURANCE CELL
IQAC Coordinator
DHARAMPETH M. P. DEO MEMORIAL & SCIENCE COLLEGE, NAGPUR

Prave
Principal
Dharampeth M. P. Deo Memorial Science College, Nagpur.

60] Abhiraj . K. Kanajiya | 8788170924 | abhirajkanajiya@gmail.com (AK)

61] Nikhil . K. Jankar | 8530960407 | Nikhiljankar@gmail.com (NK)

62] Prathmesh . S. Badhve | 9765262138 | Prathmeshbadhve@gmail.com (Prathmesh)

63] Pratham - m. Sonar | 8278451974 | Sonarpratham434@gmail.com (Pratham)

~~64] Sagari -~~

64] Damini M. Bandbuche | 8275105785 | bandbuchedamini@gmail.com / D-Bandbuche

Prathmesh



CO ORDINATOR
INTERNAL QUALITY ASSURANCE CELL
DHARAMPETH, M. P. DEO MEMORIAL &
SCIENCE COLLEGE, NAGPUR





Principal
Dharampeth M.P. Deo Memorial
Science College, Nagpur.



Dharampeth M. P. Deo Memorial Science College, Nagpur
Academic Session: 2022-23

Criteria:

1)	Name of the Department	: SPORTS AND PHYSICAL EDUCATION
2)	Name of the Activity	: Nagpur Gramin Taluka Kabaddi Tournament
3)	Date	: 22.11.2022
4)	Class	: Under 14/17/19 Boys and Girls
5)	Teacher In charge	: Dr. Rahul Kalode
6)	Name of Chief Guest	: Dr.Akhilesh V. Peshwe Principal, Dharampeth M.P.Deo Memorial Science College Nagpur
7)	Topic	: Nagpur Gramin Taluka Kabaddi Tournament
8)	Venue	: Dharampeth M. P. Deo Memorial Science College, Nagpur ground
9)	Number of students participated	: Each category 10 teams
10)	DVV Format	: NA
11)	Outcome	: Students participated in sports , support their favourite team to create sports enrolment also interaction with
12)	Photos	:
		



Dr. N.P. Gaikwad
IQAC Coordinator



Dr. Rahul D. Kalode
Name & Signature of Teacher in-Charge
Deptt. of Physical Education
Dharampeth M.P. Deo Memorial
Science College, Nagpur



Dr. Akhilesh Peshwe
Principal
Dharampeth M.P. Deo Memorial
Science College, Nagpur.



DHARAMPETH M. P. DEO MEMORIAL SCIENCE COLLEGE, NAGPUR
INTERNAL QUALITY ASSURANCE CELL (IQAC)

Activity Report

Date: 21/11/2022

Name of Organizing Department or Committee: Department of Microbiology

Name of the activity: Project on mechanism action of various antibiotic against pathogen.

Suggested CRITERION point if any:

Date of Activity: 21/11/2022

Place of Activity: Department of Microbiology Dharampeth MP Deo Memorial Science College, Nagpur.

Name of Guest Speaker/s or Judge/s or Chief Guest/s if any: Nil

Title of the Activity: Project on mechanism action of various antibiotic against pathogen on Paper I Unit IV for semester V students.

Number of Participants: 28 students.

Name of the Teacher In-charge / Convener: Dr. Pratiksha V. Pohekar

Names of other Committee Members / Staff:

OUTCOME of the Activity with respect to mission vision of the institute and or academics:

- Project on collecting information on particular topic this activity is just like self-study, When a student explores a topic on their accord, they are actively engaging with the information.
- By this activity student can think about topics more deeply. Because students are engaged and excited about the things they are learning, they can make stronger connections between what they are learning, and remember it better.
- Students learn how to work better in groups providing their own input, listening to others, and resolving conflicts when they arise.

 DHARAMPETH M.P. DEO MEMORIAL SCIENCE COLLEGE

SUBJECT :- MICROBIOLOGY PROJECT
TOPIC NAME :- CHLORAMPHENICOL

PRESENTERS:-

1. Anjali Pali
2. Ishika Thakre
3. Anushri Wale
4. Dhargavi Sambhara
5. Laxmi Gorle
6. Sayali Lokhande
7. Nandini Hadge

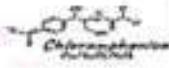

CLASS:- BSc 3rd SEM
BATCH:- T-13-14
GROUP:- CBM -CZM

DHARAMPETH M.P. DEO MEMORIAL SCIENCE COLLEGE

MICROBIOLOGY PROJECT
TOPIC NAME:- Mechanism action of Fluoxacin
Presented by
Shreyashi Nalkar
Krushali Kade
Shrutika Chadge
Shweta Dabwat
Vivik Singhurwagh

Class:- Bsc sem: 3rd
Group:- CBM
BATCH:- T13

Name & Signature of Teacher In-charge

Prof. Pitambar Humane
IQAC Coordinator

Dr. Akhilesh Peshwe
Principal

Sem V
(4)



DHARAMPETH M. P. DEO MEMORIAL SCIENCE COLLEGE,
North Ambazari Road, Near Ambazari Lake, Nagpur-440033

DATA VALIDATION & VERIFICATION (DVV)

Name of the Programme : Project on Mechanism action of various antibiotic against pathogen.
Date of the Programme : 21/11/22 (Sem V)
Name of Chief Guest if any :
Name of Guest Speaker if any :

Sr. No.	Name of the Participant	Mobile Number	E-mail Id	Signature
1	Anjali R. Pali	7498102109	pallianjali446@gmail.com	
2	Shruti M. Pawar	9527988107	Shruti Pawar 0001@gmail.com	
3	Nandini Suresh Hodge	9370301679	nandinihodge17@gmail.com	
4	Bhargavi A. Sambare	7709403806	bhargavisambare5@gmail.com	
5	Vijay K. R. Wadwade	8956482891	vijaykrwadwade@gmail.com	
6	Ishita S. Thakre	8010907069	ishithakre22@gmail.com	
7	Anushri S. Wale	8530718433	anushriwale2001@gmail.com	
8	Shreyansh S. Naikwar	7447844169	shreyanshnaikwar@gmail.com	
9	Samiksha N. Kundekar	9145253158	samikshakundekar@gmail.com	
10	Samiksha R. Chaudhari	7517090406	chaudhari samiksha 26@gmail.com	

Signature of:

Programme In-charge

IQAC Coordinator

Principal
Dharampeth M. P. Deo Memorial
Science College, Nagpur



DHARAMPETH M. P. DEO MEMORIAL SCIENCE COLLEGE,
North Ambazari Road, Near Ambazari Lake, Nagpur- 440033

DATA VALIDATION & VERIFICATION (DVV)

11.	Ayushi Shukla	9373668043	ayushishukla28112002@gmail.com	Shukla
12.	Bhumi D. Chedye	8830391103	bhunikachedye@gmail.com	Chedye
13.	Kavima S. Bamsod	7389812507	kavimabamsod401@gmail.com	Kavima
14.	Roshi M. Bambal	9325853408	roshani2018bb@gmail.com	Bambal
15.	Neh-J. Chandrahe	9370570135	nphachandrahe346@gmail.com	Chandrahe
16.	Anvi R. Bhoyar	8788031173	anvicitabhoyar@gmail.com	Anvi
17.	Mitali S. Shinde	7249637434	manalishinde062@gmail.com	Shinde
18.	Sayali S. Lokhande	9356413804	sayalilokhande2910@gmail.com	Lokhande
19.	Isha B. Gupta	9373259849	isha1202gupta@gmail.com	Gupta
20.	Avanti A. Chaphekar	7875173847	avanti1011@gmail.com	Avanti
21.	Poojali L. Dande	9325473318	donaleraojalir@gmail.com	Dande
22.	Altha Sakharwale	9405197842	althasakharwale@gmail.com	Sakharwale
23.	Asmita Bhagat	7558367348	shardabagat15@gmail.com	Bhagat
24.	Asmita D. Gaydhane	9527250282	asmitagaydhane@gmail.com	Asmita
25.	Rinam C. Wankhede	8010966529	wankhedorinam@gmail.com	Wankhede

(Handwritten signature)

Shubham
In-charge of:

Dharampeth M. P. Deo Memorial
Science College, Nagpur



DHARAMPETH M. P. DEO MEMORIAL SCIENCE COLLEGE, NAGPUR
INTERNAL QUALITY ASSURANCE CELL (IQAC)

Activity Report

Date: 21-11-2022

Name of Organizing Department or Committee: Department of Statistics

Name of the activity: Fitting a Pareto curve to the given data.

Suggested CRITERION point if any:

Date of Activity: 21th November 2022

Place of Activity: Statistics lab

Name of Guest Speaker/s or Judge/s or Chief Guest/s if any:

Title of the Activity: Fitting a Pareto curve to the given data.

Number of Participants: 18

Name of the Teacher: Gauri Sinekar

Names of other Committee Members / Staff: N.A.

OUTCOME of the Activity with respect to mission vision of the institute and or academics:

Students get the knowledge about Pareto Distribution. With the help of Pareto distribution, students fit the curve of Pareto Distribution. How to analyse data regarding Pareto Distribution.

Activity with newspaper coverage if any: No

Activity data save in PC of: Department of Statistics

Prof. Pitambar Humane
IQAC Coordinator

CO ORDINATOR
INTERNAL QUALITY ASSURANCE CELL
DHARAMPETH, M. P. DEO MEMORIAL &
SCIENCE COLLEGE, NAGPUR

Name & Signature of Teacher In-charge

Dr. Akhilesh Peshwe
Principal

Principal
Dharampeth M.P. Deo Memorial
Science College, Nagpur.



DHARAMPETH M. P. DEO MEMORIAL SCIENCE COLLEGE NAGPUR

Department of Statistics

Class: B.Sc. Sem.- III

NEP ACTIVITY

Paper- II

Unit- III

Name of the Teacher: Gauri S. Sinekhar

Date 21/11/22

Title of Activity: Fitting a Pareto curve to the given data

Sr. No.	Name of Student	Batch	Mobile No.	Email ID	Signature
1.	Ketan S. Bhojor	SCOM	9657957276	ketankhojor33@gmail.com	
2.	Harshal N. Afankar	SCOM	9527752359	Harshalafankar2001@gmail.com	
3.	Isha S. Nemade	SCOM	7028494761	ishanemade.72@gmail.com	
4.	Vicky A. Singh	SCOM	9834782931	vicky.singh11032001@gmail.com	
5.	Suman R. Singh	SCOM	9322018536	sumansingh123456789@gmail.com	
6.	Sahil B. Singh	S.COM	7258889502	sahilbsingh@gmail.com	
7.	Aman D. Chauhan	S.COM	7219466153	amanchauhan2@gmail.com	
8.	Prajakta Pawar	SCOM	9356905759	prajakta2606@gmail.com	
9.	Swamini S. Rajankar	S.COM	9822200598	swaminisrajanekar@gmail.com	
10.	Purneshottam P. Pawar	S.COM	7020643071	pawarkapurneshottam@gmail.com	
11.	Anjali Y. Langankar	S.COM	8830037253	anjaliy.langankar@gmail.com	
12.	Vrushali Shobare	SCOM	9307516832	vrushalishobare25@gmail.com	
13.	Saarthak Jichkan	SCOM	8605710878	saarthakjichkan@gmail.com	
14.	Avishkar N. Bansod	S.COM	7820861987	avishkarbansod01@gmail.com	
15.	Sumit Sable	SCOM	9022103000	sumitsable02@gmail.com	
16.	Devang Koria	SCOM	7888238500	devang@gmail.com	
17.	Khushi Dagarjadh	SCOM	9156520783	khushidagarjadh@gmail.com	
18.	Veishnavi Jadhav	SCOM	9165916355	vj0806593@gmail.com	

G. Sinekhar
Signature of Teacher

G. Sinekhar
Teacher Incharge



DHARAMPETH M. P. DEO MEMORIAL SCIENCE COLLEGE, NAGPUR
INTERNAL QUALITY ASSURANCE CELL (IQAC)

Activity Report

Date: 30/11/22

Name of Organizing Department or Committee: Zoology

Name of the activity: Zoology museum exhibition for school students

Suggested CRITERION point if any: Criteria V

Date of Activity: 22/11/2022

Place of Activity: Zoology laboratory

Name of Guest Speaker judge/s or Chief Guest/s if any: Honourable Shri Ratnakar Kekatpure, Honourable Shri Majgeshji Pathak, Dr. Akhilesh Peshwe

Title of the Activity: Zoology museum exhibition for school students

Number of Participants: 358

Name of the Teacher In-charge / Convener: Dr. K. M. Paturkar

Names of other Committee Members / Staff: Dr. K. M. Paturkar students of Zoological Society

OUTCOME of the Activity with respect to mission vision of the institute and or academics:

Volunteer students get expert in identifying the specimen from different phyla

School students get exposure and acquire more knowledge about rare specimens, models, life cycles, embryos, skeleton etc.

Volunteer students get opportunity to express their acquired knowledge of the subject.

Activity with newspaper coverage if any: NIL

Activity data save in PC of: Zoology Department/personal laptop



Prof. Pitambar Humane
IQAC Coordinator

CO ORDINATOR
INTERNAL QUALITY ASSURANCE CELL
DHARAMPETH, M. P. DEO MEMORIAL &
SCIENCE COLLEGE, NAGPUR

Dr. Kirti Paturkar
Name & Signature of Teacher In-charge

Dr. Akhilesh Peshwe
Principal

Principal
Dharampeth M. P. Deo Memorial
Science College, Nagpur

**DHARAMPETH M. P. DEO MEMORIAL SCIENCE COLLEGE,**

North Ambazari Road, Near Ambazari Lake, Nagpur-440033

DATA VALIDATION & VERIFICATION (DVV for Students)

Name of the Programme : Zoology Museum Exhibition 2022-23

Date of the Programme : 22/11/2022

Name of Chief Guest if any :

Name of Guest Speaker if any :

Sr. No.	Name of the Participant	Class/Semester	Mobile Number	E-mail Id	Signature	Remark
1.	Sayali K. Pandharpande	Sem V	8208121810	Sayali.p0459@gmail.com		
2.	Shruti M. Pawar	Sem V	9527988707	shruti.pawar.0001@gmail.com		
3.	Ishika Thakur	Sem V	8010907069	ishithakur22@gmail.com		
4.	Arvika. Bhoyar	Sem V	8788031173	arvicabhojar@gmail.com		
5.	Karishma Bamaad	Sem V	7389812507	karishmabamaad101@gmail.com		
6.	Siddharth Huskane	Sem III	9579092932	huskanesiddharth1234@gmail.com		
7.	Vanshika Yede	Sem V	7552244609	vanshikayede1@gmail.com		
8.	Saniya Naik	Sem V	9370570457	saniyanair5@gmail.com		
9.	Yukti Choudhary	Sem III	7020958938	yukti.choudhary1802@gmail.com		
10.	Vaishali S. Patil	Sem III	9322600647	Vaishalipatil1709@gmail.com		
11.	Yashashree P. Chaudhary	Sem III	9769008929	Yashashreechaudhary@gmail.com		
12.	Shikha J. Yadav	Sem III	7263881320	Shikhayadav57@gmail.com		
13.	Subbu R. Mishra	Sem III	9860436418	Subburamishra1234@gmail.com		
14.	Sushma G. Gunuru	Sem III	9156238747	sushmagunuru@gmail.com		
15.	Riya R. Kulkarni	Sem III	7420956528	riyakulkarni12@gmail.com		
16.	Jyoti. J. Sharma	Sem III	8669736380	jyoti.s8390@gmail.com		

Signature of:
Programme In-charge
IQAC Coordinator
PrincipalDharampeth M.P. Deo Memorial
Science College, Nagpur.



DHARAMPETH M. P. DEO MEMORIAL SCIENCE COLLEGE,
North Ambazari Road, Near Ambazari Lake, Nagpur-440033

DATA VALIDATION & VERIFICATION (DVV for Students)

Sr. No.	Name of the Participant	Class/Semester	Mobile Number	E-mail Id	Signature	Remark
17.	Pratiksha. Iteshwar	I st sem	8459070338	pratiksha.iteshwar@gmail.com		
18.	Harshad warthi	2nd year	7414993575	harshadwarthi9592@gmail.com		
19.	Khushi Rewade	1 st sem	9588445994	khushirewade@gmail.com		
20.	Aakanya Y. mairal	1 st sem	8010923662	aakanyagi2004@gmail.com		
21.	Chandak. K. Waghware	Sem - I	7796016894	waghwarechandak@gmail.com		
22.	Krutika Pokate	Sem I	9021535341	pokatekrutika6@gmail.com		
23.	Devashri Bisen	Sem III	8698119078	DKBisen74@gmail.com		
24.	Mounali Sonare	Sem IV	9850163812	Sonaremounali16@gmail.com		
25.	Mounali Ramteke	Sem III	9146003783	mounaliramteke0538@gmail.com		
26.	Krushabai Chaudhari	Sem III	7262074980	krushabai.chaudhari96@gmail.com		
27.	Bhargavi Sambare	Sem V	7709403806	bhargavisambare00@gmail.com		
28.	Karimi Gole	Sem V	7758058514	karimigole00@gmail.com		
29.	Nandini Hodge	Sem V	9370301679	nandinihodge1@gmail.com		
30.	Tisha Kature	Sem V	9021541048	tishakature@gmail.com		
31.	Neha Chandratrae	Sem V	9370570833	nehachandratrae346@gmail.com		
32.	Harsh Kockpe	Sem III	9604677672	harshkockpe009@gmail.com		
33.	Nilesh Hulle	Sem III	8624091652	hulle-nilesh@gmail.com		
34.	Vishnavi Gadge	Sem III	9022976449	gadgenavishnavi@gmail.com		
35.	Garzi Hodge	Sem III	7972076671	garzihodge@gmail.com		
36.	Prasanna S. Bhojare	Sem III	8010434634	Prasanna6738@gmail.com		
37.	Jaagruhi D. Warkare	Sem III	7447366023	jaagruhidwarkare09@gmail.com		
38.	Sakshi S. Meshram	Sem III	9195117733	Sakshimeshram@gmail.com		

Signature of:
Programme In-charge

IQAC Coordinator
Dharampeth M. P. Deo Memorial
Science College, Nagpur-440033

Principal
Dharampeth M.P. Deo Memorial
Science College, Nagpur.



DHARAMPETH M. P. DEO MEMORIAL SCIENCE COLLEGE,
North Ambazari Road, Near Ambazari Lake, Nagpur- 440033
DATA VALIDATION & VERIFICATION (DVV for Visitors)

Name of the Programme : Zoology Museum Exhibition 2022-23
Date of the Programme : 22/11/2022
Name of Chief Guest if any :
Name of Guest Speaker if any :

①MP (JR)

Sr. No.	Name of the Participant	Class/Semester	Mobile Number	E-mail Id	Signature	Remark
1.	Shruti Dongre	12 th			Shruti	
2.	Shravani Thakre	12 th			Shravani	
3.	Tanesh Pandam	15 th year			T. Pandam	
4.	Tushar K. Kashyap	11 th			Tushar	
5.	Ritesh Sonone	11 th			R	
6.	Divyanshu Shetty	11 th			Divyanshu	
7.	Rohit Gupta	11 th			Rohit	
8.	Divya Chaudhari	11 th			Divya	
9.	Swatanjali Humane	11 th			Humane	
10.	Diksha Bambode	12 th			Bambode	
11.	Anushka Kawale	12 th			Anushka	
12.	Divya Gaurande	12 th			Divya	
13.	Chaggeshwar Kumbhar	12 th			Chaggeshwar	
14.	Mahi Thaware	1 st year			Mahi	
15.	Rutika Sondliya	1 st year			Rutika	
16.	Samarudhi Devgade	12 th			Samarudhi	

Signature of: 
Programme In-charge



IQAC Coordinator
Dharampeth M. P. Deo Memorial
Science College, Nagpur-440033

Principal
Dharampeth M. P. Deo Memorial
Science College, Nagpur.



DHARAMPETH M. P. DEO MEMORIAL SCIENCE COLLEGE,
North Ambazari Road, Near Ambazari Lake, Nagpur- 440033
DATA VALIDATION & VERIFICATION (DVV for Visitors)

Sr. No.	Name of the Participant	Class/Semester	Mobile Number	E-mail Id	Signature	Remark
17.	Kujal Bhange	12	9284059210		Kujal	
18.	Sakshi Bhaskar	11	9021895503		Sakshi	
19.	Nirmal Nege	11			Nirmal	
20.	Chyruul Sawarkar	11			Chyruul	
21.	Banshika Kachure	11				
22.	Vidya Chaudhari	11	976		Vidya	
23.	Neha Sharma	11			Neha	
24.	Shruti Kaware	11			Shruti	
25.	Simari Sanghvi	11			Simari	
26.	Nishant Tamwar	11			Nishant	
27.	Vishal R. Achare	11			Vishal	
28.	Ranika N. Jitkar	11			Ranika	
29.	Komal R. Ingole	11			K. R. Ingole	
30.	Praveen Kachur	11			Praveen	
31.	Sushant Nimalkar	11			Sushant	
32.	Muskan Rahangdale	11			Muskan	
33.	Kritika R. Hajare	11	7822081834		Kritika	
34.	Akshiti Singh	11	9067128956		Akshiti	
35.	Nisha. Waykade	11	7499030515		Nisha	
36.	Saloni C. Landge	11	9694703706		Saloni	
37.	Pratham B. Wagh	11	9321376519		Pratham	
38.	Lucky Rahangdale	11	9698518793		Lucky	

Signature of: 
Programme In-charge

IQAC Co-ordinator

Dharampeth M.P. Deo Memorial
Science College, Nagpur-440033

Principal
Dharampeth M.P. Deo Memorial
Science College, Nagpur.



DHARAMPETH M. P. DEO MEMORIAL SCIENCE COLLEGE,

North Ambazari Road, Near Ambazari Lake, Nagpur- 440033

DATA VALIDATION & VERIFICATION (DVV for Visitors)

Sr. No.	Name of the Participant	Class/Semester	Mobile Number	E-mail Id	Signature	Remark
39.	Aj Yash Nannawate	10 th				
40.	Manasi Pimple	10 th				
41.	Judiksha Durkar	10 th				
42.	Ruchraksha Pardey	10 th				
43.	Shravya Hadke	9 th				
44.	S. Sameep	10 th				
45.	Shamwari Agarkar	9 th				
46.	Komal Marathe	9 th				
47.	Pranav Gupta	10 th				
48.	Bhavesh Shende	10 th				
49.	Asharu. Dhore	9 th				
50.	Omiga Gupta	9 th				
51.	Rishi D. Rajbale	9 th				
52.	Aashita Chavare	10 th				
53.	Sumedha Gupta	10 th				
54.	Tarun Athwasi	9 th				
55.	Argala Tyer	9 th				
56.	Deepika Rane	9 th				
57.	Neha Vishwakarma	2 nd year H.S.				
58.	Anshikha Jagtapkar	-11-				
59.	Hemlata D. Verma	-11-				
60.	Geeta Chaudhari	-11-				

Signature of:
Programme In-charge

IQAC Coordinator

IQAC Co-ordinator

Dharampeth M. P. Deo Memorial

Principal

Principal

Dharampeth M.P. Deo Memorial
Science College, Nagpur.

Saraswati
School

D.M.P.
Home
Science



DHARAMPETH M. P. DEO MEMORIAL SCIENCE COLLEGE,
North Ambazari Road, Near Ambazari Lake, Nagpur- 440033

DATA VALIDATION & VERIFICATION (DVV for Visitors)

Sr. No.	Name of the Participant	Class/Semester	Mobile Number	E-mail Id	Signature	Remark
61.	Saloni T. Patle	10 th	7875445107		Saloni	
62.	Lakshita P. Bisen	10 th	9049880868		Lakshita	
63.	Prachi R. Kerkar	10 th	9881864563		Prachi	
64.	Disha S. Meshram	10 th	9975733738		Disha	
65.	Arshi Patle	8 th	7875445107		Arshi	
66.	Bhumika Singh	8 th	8368622688		Bhumika	
67.	Radha Yegaonkar	8 th	9850209738	aparadha21@gmail.com	Radha	
68.	Sakshi Chauhan	9 th	9699756006		Sakshi	
69.	Sneha Bisen	9 th	9164786667		Sneha	
70.	Aarushi Manik	9 th	738532538		Aarushi	
71.	Sakshi V. Borkar	9 th	9765255845		Sakshi	
72.	Prachi P. Pache	9 th	9657878114		Prachi	
73.	Pragati P. Menane	9 th	9322619003		Pragati	
74.	Priyush Malawat	10 th	8767315216		Priyush	
75.	Anuj Lence	10 th	7198777462		Anuj	
76.	Mohit N. Hakwar	10 th			Mohit	
77.	Rishi D. Patle	10 th	9503222499		Rishi	
78.	Aditya R. Ram	10 th	7066453472		Aditya	
79.	Utkas Badwani	11 th			Utkas	
80.	Kaustubh Nikel	11 th			Kaustubh	
81.	Yashbhore Nikel	11 th	8329192538		Yashbhore	
82.	Ishan Jamgade	11 th	8329192538		Ishan	

VS content

V.S. Content

D.M.P. J.R.

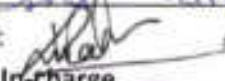
Signature of: 
Programme In-charge

IQAC Coordinator
IQAC Co-ordinator

Principal

Dharampeth M.P. Deo Memorial
Science College, Nagpur.



DHARAMPETH M. P. DEO MEMORIAL SCIENCE COLLEGE,
North Ambazari Road, Near Ambazari Lake, Nagpur- 440033
DATA VALIDATION & VERIFICATION (DVV for Visitors)

Name of the Programme : Zoology Museum Exhibition 2022-23
Date of the Programme : 22/11/2022
Name of Chief Guest if any :
Name of Guest Speaker if any :

Sr. No.	Name of the Participant	Class/Semester	Mobile Number	E-mail Id	Signature	Remark
1.	Mansj mate	sem-III	8468891809	mansj19182@fambh.com		
2.	Juhi Chaudhari	Sem-III				
3.						
4.						
5.						
6.						
7.						
8.						
9.						
10.						
11.						
12.						
13.						
14.						
15.						
16.						

Signature of:
Programme In-charge

IQAC Coordinator
IQAC Co-ordinator
Dharampeth M.P. Deo Memorial
Science College, Nagpur-440033

Principal
Principal
Dharampeth M.P. Deo Memorial
Science College, Nagpur,



DHARAMPETH M. P. DEO MEMORIAL SCIENCE COLLEGE,
North Ambazari Road, Near Ambazari Lake, Nagpur- 440033
DATA VALIDATION & VERIFICATION (DVV for Visitors)

Sr. No.	Name of the Participant	Class/Semester	Mobile Number	E-mail Id	Signature	Remark
17.	Vug B Meshram	12				
18.	Ayush P. Mandape	11				
19.	Rishabh P. Khudse	11				
20.	Yash R. Rampure	12 th				
21.	Aarav Karmkar	11 th				
22.	Kaustubh Chelmalwar	11 th				
23.	Tejas G. Solankar	12 th Sem				
24.	Shriya S. Bagde	Sem III				
25.	Janvi D. Patle	11 th				
26.	Krushika Bhabhate	11 th				
27.	Jyashnvi Lambert	11 th				
28.	Jagruhi R. Waghmare	11 th				
29.						
30.						
31.						
32.						
33.						
34.						
35.						
36.						
37.						
38.						

Signature of:
Programme In-charge

IQAC Coordinator
IQAC Co-ordinator
Dharampeth M.P. Deo Memorial
Science College, Nagpur-440033

Principal
Dharampeth M.P. Deo Memorial
Science College, Nagpur.



DHARAMPETH M. P. DEO MEMORIAL SCIENCE COLLEGE,
North Ambazari Road, Near Ambazari Lake, Nagpur- 440033
DATA VALIDATION & VERIFICATION (DVV for Visitors)

Name of the Programme : Zoology Museum Exhibition 2022-23
Date of the Programme : 22/11/2022
Name of Chief Guest if any :
Name of Guest Speaker if any :

Sr. No.	Name of the Participant	Class/Semester	Mobile Number	E-mail Id	Signature	Remark
1.	Ruchi kokarde	8th			Ruchi kokarde	
2.	Karuna dable	8th			Karuna dable	
3.	Ragini sonetkar	8th			Ragini sonetkar	
4.	Tanushree Sunbarte	8th			Tanushree Sunbarte	
5.	Muradina sonetkar				Muradina	
6.	Ashwini Dhafekar	8th			A. Dhafekar	
7.	Sahil Mahale	9th			Sahil	
8.	Ritesh Velupe	9th			Ritesh	
9.	Daksh Ashok	9th			Daksh	
10.	Nisarg Sakhare	9th			N. P. Sakhare	
11.	Yash Kumbhare	8th			Y.K.	
12.	Ranveer Chopra	10th			Ranveer	
13.	Mithilesh M. Bhagat	9th			M. Bhagat	
14.	Nayan Nimasde	9th			Nayan	
15.	Sureya Ramteke	9th			Sureya	
16.	Tanisha Uke	9th			Tanisha	

Mahamastar
Aadhyam
Kadhir

Signature of: 
Programme In-charge

IQAC Coordinator
IQAC Co-ordinator

Principal
Dharampeth M.P. Deo Memorial
Science College, Nagpur,





DHARAMPETH M. P. DEO MEMORIAL SCIENCE COLLEGE,

North Ambazari Road, Near Ambazari Lake, Nagpur- 440033

DATA VALIDATION & VERIFICATION (DVV for Visitors)

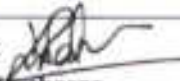
Sr. No.	Name of the Participant	Class/Semester	Mobile Number	E-mail Id	Signature	Remark
17.	Netra Vishwakarma	10 th			Netra	
18.	V.S Convent					
19.	Kunal .t. Biseri	9 th	9049474812		Kunal	
20.	Mohini Patte	9 th			Mohini	
21.	Akanksha .Khande	9 th			Akanksha	
22.	Susma .Patte	9 th	8550937569		Susma	
23.	Abhidhek .Tuskar	10 th	8657848637		Abhidhek	
24.	Nash Naume	9 th	9923811160		Nash	
25.	Bittu Pandit	9 th	8329054642		Bittu	
26.	Pooja Manekar	10 th	9145582985		Pooja	
27.	Ridhima Bankar	10 th	9276284637		Ridhima	
28.	Shubhangi Jamgade	10 th	9689039917		Shubhangi	
29.	Renuka Matre	10 th	9604873828		Renuka	
30.	Nancy Gaudam	10 th	9422827912		Nancy	
31.	Swarni Jamgade	8 th	8482867644		Swarni	
32.	Rashmi Dinda	8 th	9096594378		Rashmi	
33.	Arut Ramteke	8 th			Arut	
34.	Vedant Gadgil	8 th	957915199		Vedant	
35.	Daly-z. Dohare	8 th	976656198		Daly-z	
36.	Laxmi M. Bhat	8 th A			Laxmi M. Bhat	
37.	Anamika A. Warshole	8 th A			Anamika	
38.						

Signature of: 
Programme In-charge

IQAC Co-ordinator
Dharampeth M. P. Deo Memorial
Science College, Nagpur-440033

Principal
Dharampeth M. P. Deo Memorial
Science College, Nagpur.



DHARAMPETH M. P. DEO MEMORIAL SCIENCE COLLEGE,
North Ambazari Road, Near Ambazari Lake, Nagpur-440033

DATA VALIDATION & VERIFICATION (DVV for Visitors)

Sr. No.	Name of the Participant	Class/Semester	Mobile Number	E-mail Id	Signature	Remark
39.	Khushi Dongare	9th				
40.	शशि आर्य	9th				
41.	Kuruli Raut	9th				
42.	Mandini Jammik	8th			N J	
43.	Suhani Meshram	8th			Suhani	
44.	Suhana Wikey	9th			Suhana	
45.	LUCKY DHOKE	8th				
46.	Kunal Wikey	8th			LUCKY	
47.	Lo Keshi Wankar	8th				
48.	Aditya Bavankar	9th				
49.	Tushar Raut	9th			Tushar	
50.	Pavani Meshram	9th				
51.	Santosh Ravi Radke	9th			SANTOSH	
52.	Ashwin Sonwane	9th				
53.	Shriyash Gupta	11th				
54.	Khushbu Goutam	11th				
55.	Ravina Chavragale	11th			Ravina	
56.	Muskan D. Bisne	11th				
57.	Nikhil C. Madame	11th			Nikhil.	
58.	Grestanjali R. Lahare	11th				
59.	Sonali R. Yadav	12th				
60.						

Maharaja
Science
College

Tarkunde
Science
College

Signature of:
Programme In-charge

IQAC Coordinator

Dharampeth M.P. Deo Memorial
Science College, Nagpur

Principal

Dharampeth M.P. Deo Memorial
Science College, Nagpur,



DHARAMPETH M. P. DEO MEMORIAL SCIENCE COLLEGE,
North Ambazari Road, Near Ambazari Lake, Nagpur- 440033

DATA VALIDATION & VERIFICATION (DVV for Visitors)

Sr. No.	Name of the Participant	Class/Semester	Mobile Number	E-mail Id	Signature	Remark
61.	Aditi Vaidya	1 Sem	9075714591	Aditivaidya619@gmail.com		
62.	Alinal Patil	1 Sem				
63.	Bhavana Pusarkar	1 Sem	8888437303	bhavangpusarkar@gmail.com		
64.	SAKSHI R. CHAKUNDE	1 Sem	7843018801			
65.	Shalu Pawde	1 Sem				
66.	Nidhi Gawai	1 Sem	8767867943			
67.	Gehana Mishra					
68.	Gunjan Shiwanekar					
69.	Prince Sharma		6203503006			
70.	Pragwal C. Poddhane		7049318387			
71.	Pratik Dhule	8 th A	8926445861			
72.	Arun Manjhar	8 th A	9764888308			
73.	Vedant D. Khende	8 th B	9823594250			
74.	Yatharth A. Khatke	8 th A	9404835554	Yatharthkhatke@gmail.com		
75.	Preraj G. Athavale	8 th B	855498577			
76.	Himesh P. Lonball	8 th B	8767532637			
77.	Mayuk B. Gadhane	9 th A	9604622318			
78.	Mayuk Meshram	9 th A	9049932152	meshrammayuk3@gmail.com		
79.	Shrikanth D. Kulkarni	9 th A	808084392			
80.	Pragati Mankar	10 th (A)	9145588985			
81.	Pratiksha Dhaware	10 th (A)	839065167			
82.	Anishya Pradhan	10 th (B)	9579896778			

Signature of:
Programme In-charge

IQAC Coordinator

IQAC Co-ordinator
Dharampeth M. P. Deo Memorial
Science College, Nagpur

Principal

**Dharampeth M. P. Deo Memorial
Science College, Nagpur.**

D.M.P
Home Science

V.S
Convent



DHARAMPETH M. P. DEO MEMORIAL SCIENCE COLLEGE,
North Ambazari Road, Near Ambazari Lake, Nagpur- 440033
DATA VALIDATION & VERIFICATION (DVV for Visitors)

Name of the Programme : Zoology Museum Exhibition 2022-23
Date of the Programme : 22/11/2022
Name of Chief Guest if any :
Name of Guest Speaker if any :

Sr. No.	Name of the Participant	Class/Semester	Mobile Number	E-mail Id	Signature	Remark
1.	Dipali Kusale	11 th A	738793		Dipali	
2.	Riya Gawarde	11 th B			Riya	
3.	Shruti Purohit	11 th B	9373203408		Shruti	
4.	Zakshi Purohit	11 th A	7028428300		Zakshi	
5.	Kaveri Kale	11 th A	7263000739		Kaveri	
6.	Seva Sadan School					
7.	Mansi Gaurai	I year			Mansi	
8.	Vaishnavi Shende	I year			Vaishnavi	
9.	Ruchika Fate	I year			Ruchika	
10.	Sojal Patil	I year			Sojal	
11.	Aarti Wable	2 nd year			Aarti	
12.	Shradha Warthi				Shradha	
13.	Dinesh Salame	B.Sc. 1 st year			Dinesh	
14.	Sai Peetla	BSC 1 st year			Sai	
15.	Jushal Lonare	BSC 1 st year			Jushal	
16.						

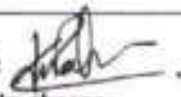
Signature of: 
Programme In-charge

IQAC Coordinator

IQAC Co-ordinator
Dharampeth M.P. Deo Memorial
Science College, Nagpur-440033

Principal

Principal
Dharampeth M.P. Deo Memorial
Science College, Nagpur,



DHARAMPETH M. P. DEO MEMORIAL SCIENCE COLLEGE,
North Ambazari Road, Near Ambazari Lake, Nagpur- 440033

DATA VALIDATION & VERIFICATION (DVV for Visitors)

Sr. No.	Name of the Participant	Class/Semester	Mobile Number	E-mail Id	Signature	Remark
17.	Kanshika Khandare	8 th			Kanshika Khandare	
18.	Pooja Sibam	8 th			Pooja Sibam	
19.	Vaishnavi Kaurate	8 th			Vaishnavi K.	
20.	Aman W. Hatwar	9 th			Aman	
21.	Trias P. Mungwar	9 th			Mungwar	
22.	Samak P Bagde	9 th			Jayesh	
23.	Jayesh Jambhe	9 th			Jk	
24.	Uinay Rande	8 th			Uinay	
25.	Ritesh Salame	8 th				
26.	Kunal Dhadwe	9 th			Ritesh	
27.	SASSAKSHI TAYWANE	8 th			Kunal	
28.	Sonu	9 th			SAKSHI	
29.	priya Donge	9 th			Sonu	
30.	Krishiti Kokate	9 th			Priya	
31.	Jiya	9 th			Krishiti	
32.	Manisha Katar	9 th			Jiya	
33.	सिद्धी शिंदे	8 th			Manisha	
34.	शिवानी मोगम	9 th			Siddhi	
35.	पिशा & खंडारे	8 th			शिवानी	
36.	Tarvi Pundhare	8 th			पिशा	
37.	प्रेया नेवारे	8 th			TR प्रेया नेवारे	
38.	SUSHMA	8 th			SUSHMA	

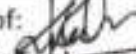
Signature of: 
Program in-charge

IQAC Coordinator

Dharampeth M. P. Deo Memorial
Science College, Nagpur-440033

Principal

Dharampeth M. P. Deo Memorial
Science College, Nagpur.

Wahonshika
Akhayganga
Khandare



DHARAMPETH M. P. DEO MEMORIAL SCIENCE COLLEGE,
North Ambazari Road, Near Ambazari Lake, Nagpur- 440033
DATA VALIDATION & VERIFICATION (DVV for Visitors)

Sr. No.	Name of the Participant	Class/Semester	Mobile Number	E-mail Id	Signature	Remark
39.	Shrawan. A. Senkuste	12			S. A. Senkuste	
40.	Himanshu R. Bawane	11			H. R.	
41.	Aryan B. Desai	11			A. B.	
42.	Sumit N. Londhate	11			Sumit	
43.	Akshay S. Pawar	11			A. S.	
44.	Laksh R. Sahare	11			L. R.	
45.	Aditi G. Makode	11			A. G.	
46.	Maheshwari Kalbhut	11			M. K.	
47.	Hansh Masram	12			H. M.	
48.	Akanksha G. Sailwar	11			A. G.	
49.	Supriya J. Bhaskar	11			S. J.	
50.	Gayatri B. Meshram	11 th			G. B.	
51.	Rakas G. Gaurale	11 th			R. G.	
52.	Ayush Nesankhede	11 th			A. N.	
53.	Pragati P. Katolkar	11 th			P. P.	
54.	Ritik Bawankar	12 th			R. B.	
55.	Eshant W. Langewar	12 th			E. W.	
56.	Kalyani R. Galade	12 th			K. R.	
57.	Saurabh R. Tiwari	11 th			S. R.	
58.	Pratik D. Kadam	12 th			P. D.	
59.	Amruta Khobragade	11 th			A. K.	
60.	Shruti Gaurani	11 th			S. G.	

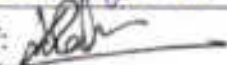
Signature of: 
Programme In-charge

IQAC Coordinator
IQAC Co-ordinator
Dharampeth M. P. Deo Memorial
Science College, Nagpur.

Principal
Dharampeth M. P. Deo Memorial
Science College, Nagpur.

Hadas
School

DMP
J.R



DHARAMPETH M. P. DEO MEMORIAL SCIENCE COLLEGE,
North Ambazari Road, Near Ambazari Lake, Nagpur- 440033
DATA VALIDATION & VERIFICATION (DVV for Visitors)

Sr. No.	Name of the Participant	Class/Semester	Mobile Number	E-mail Id	Signature	Remark
61	Saravali Savasvati School					
62.	Chinmay Avare	9 th			Chinmay	
63.	Akshat U. Patil	9 th			AP	
64.	Umesh Kale	9 th			Kale	
65.	Samaruddhi Aher	9 th			Aher	
66.	Samer Nagpure	10 th			Samer	
67.	Aaryan Hadke	9 th			Aaryan	
68.	Jay Thawali	10 th			Thawali	
69.	Katan Ingle	10 th			Katan	
70.	Harshita Gajbhaye	10 th			harshita	
71.	Angel Yekar	10 th			Angel	
72.	Tushar Singh	10 th			Tushar	
73.	Aditya Deshpande	10 th			Aditya	
74.	Tanish Itkakar	9 th			Tanish	
75.	Dahil Gawande	10 th			Dahil	
76.	Siddhik Tijare	9 th			Siddhik	
77.	Ashwarya S. Daulatkar	9 th			A.S. Daulatkar	
78.	Ketan Hajare	9 th			Ketan	
79.	Ansh Hirani	9 th			Ansh	
80.	Meshti Dhive	9 th			Meshti	
81.	Veena Thakre	9 th			Veena	
82.	Dhanashree Atkari	10 th			Dhanashree	

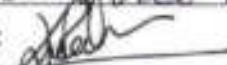
Signature of: 
Programme In-charge

IOAC Coordinator
Dharampeth M.P. Deo Memorial
Science College, Nagpur-440033



Principal
Dharampeth M.P. Deo Memorial
Science College, Nagpur



DHARAMPETH M. P. DEO MEMORIAL SCIENCE COLLEGE,
North Ambazari Road, Near Ambazari Lake, Nagpur- 440033

DATA VALIDATION & VERIFICATION (DVV for Visitors)

Sr. No.	Name of the Participant	Class/Semester	Mobile Number	E-mail Id	Signature	Remark
83.	Anurodh Pawesh	8th			Anurodh	
84.	Gaurav Meshram	8th			Gaurav	
85.	SYSRANT VIKR	8th			SYSRANT	
86.	Adarsh Raut	9th			Adarsh	
87.	Yogesh Ahire	9th			Yogesh	
88.	XXXXXXXXXX	Fartanale school	—	—	—	—
89.	Rajwade	11th			Rajwade	
90.	Latesh Rukhagada	11th			Latesh	
91.	Tarpti Dhane	11th	—	—	Tarpti	
92.	Yashasvi Nagdeve	11th			Yashasvi	
93.	Mohit. Agnihotri	11th			Mohit	
94.	Nilima Sonawane	11th			Nilima	
95.	Taishya Kanade	12th			Taishya	
96.	Bhaarti Tembhare	12th			Bhaarti	
97.	Aliya Khan	11th			Aliya	
98.	Krushbu Patil	10th			Krushbu	
99.	Nafisha Sheikh	12th			Nafisha	
100.	Gulshan Sulakhe	11th			Gulshan	
101.	Sahil Mohan	11th			Sahil	
102.	Ankaj Shah				Ankaj	
103.	Pranjal Mishra	11th			Pranjal	
104.	Pranjul Meemam	11th			Pranjul	

Signature of: 
Programme In-charge

IQAC Coordinator

Dharampeth M.P. Deo Memorial
Science College, Nagpur

Principal

Dharampeth M.P. Deo Memorial
Science College, Nagpur



DHARAMPETH M. P. DEO MEMORIAL SCIENCE COLLEGE,
North Ambazari Road, Near Ambazari Lake, Nagpur- 440033

DATA VALIDATION & VERIFICATION (DVV for Visitors)

Sr. No.	Name of the Participant	Class/Semester	Mobile Number	E-mail Id	Signature	Remark
105.	Frupti W. Tembhurnikar	11 th			Frupti	
106.	Jaravi Gautre	12 th			Jaravi	
107.	Falguni D. Raut	12 th			Falguni	
108.	Devant Barbote	11 th			D. Barbote	
109.	Ajay Pandit	11 th			Ajay	
110.	Daksh Barbote	11 th			Daksh	
111.	Yashraj Jiwari	11 th			Yashraj	
112.	Harsh Sahu	11 th			Harsh	
113.	Ruchita Kulkarni	11 th			Ruchita	
114.	Manushi Sonule	11 th			Manushi Sonule	
115.	Tannu Patle	11 th			Tannu	
116.	Shreedi Shivewar	11 th			Shreedi	
117.	Ragini Singh	12 th			Ragini	
118.	Monika Agrivasthi	12 th			Monika	
119.	Sahant S. Ladke	9 th			Sahant	
120.	Adarsh N. Mankar	9 th			Adarsh	
121.	Sakshi V. Pandey	10 th			Sakshi	
122.	Rimankshi Prapapati	10 th			Rimankshi	
123.	Harshada Kulkarni	10 th			Harshada	
124.	Harshit I. Mudaliar	10 th			Harshit	
125.	Nithlesh Rangari	9 th			Nithlesh	

Tatyasaheb
School

Somnath
School

Signature of:
Programme In-charge

IQAC Coordinator
IQAC Co-ordinator
Dharampeth M.P. Deo Memorial
Science College, Nagpur

Principal
Principal
Dharampeth M.P. Deo Memorial
Science College, Nagpur



Activity Report

Date: 23rd November 2022

Name of Organizing Department or Committee: Value Addition Committee

Name of the activity: Skit Play on drug addicted youths.

Suggested CRITERION point if any: Suggested criteria II, I and V

Date of Activity: 23rd November 2022

Place of Activity: Late Shri. Vinayakrao Phatak Hall,

Name of Guest Speaker/s or Judge/s or Chief Guest/s if any: Radhika Creations

Title of the Activity: Mohjal - [मोहजाल - ड्रग के मोहजाल में फंसे युवाओं के लिए प्रस्तुत नाटक]

Number of Participants: 91

Name of the Teacher In-charge / Convener: Prof. Varsha V. Rangari

OUTCOME of the Activity with respect to mission vision of the institute and or academics:

Report

Skit play on drug addicted youths titled "Mohaja" was played by Radhika Creation. The objective behind this play was to spread awareness in youth about the consumption and consequences of drugs. The play was written and directed by Shri. Sanjay Pendse. Dr. Pashine sir conducted the program and vote of thanks was given by Jr. College Vice principal Mrs. Vinaya Kashikar.



Prof. Pitambar Humane
IQAC Coordinator

IQAC Co-ordinator
Dharampeth M.P. Deo Memorial
Science College, Nagpur-440033

Prof. Varsha V. Rangari
Head of the Department

Dr. Akhilesh Peshwe
Principal

PRINCIPAL
Dharampeth M.P. Deo Memorial
Science College, Nagpur-440033



DHARAMPETH M. P. DEO MEMORIAL SCIENCE COLLEGE,
North Ambazari Road, Near Ambazari Lake, Nagpur- 440033

DATA VALIDATION & VERIFICATION (DVV)

Name of the Programme : 'MOHAJAL' skit play.
Date of the Programme : 22nd November 2022
Name of Chief Guest if any : NGO Radhika Creations.
Name of Guest Speaker if any : _____

Sr. No.	Name of the Participant	Mobile Number	E-mail Id	Signature
1.	Sonia Niwal	7058425021	niwalsonia70@gmail.com	<i>Sonia Niwal</i>
2.	Monali Shende	7796516257	shende.monali92@gmail.com	<i>Monali</i>
3.	Dewashi Kakale	9021344265	dewashikakale@gmail.com	<i>D. P. Kakale</i>
4.	Shubhangi Karm	7756854710	shubhangikarm@gmail.com	<i>Shubhangi</i>
5.	Rashmi G. Nabik	7030024153	shubhangikakale@gmail.com	<i>Rashmi</i>
6.	Shubhangi D. Akalkat	9552775388	shubhangikakale@gmail.com	<i>Shubhangi</i>
7.]	Rutika Yadav	8446085943	yadav.rutika434@gmail.com	<i>Rutika</i>
8.]	Shikha Deshpande	9130091540	ishitendeshpande21004@gmail.com	<i>Shikha</i>
9.]	Sakshi Mishra	9529889315	smishra39683@gmail.com	<i>Sakshi</i>
10.]	Varsha Turkar	9373650950	veveshaturkar488@gmail.com	<i>Varsha</i>

Signature of:

[Signature]
Programme in-charge

[Signature]
IQAC Coordinator

COORDINATOR
INTERNAL QUALITY ASSURANCE CELL
DHARAMPETH, M. P. DEO MEMORIAL &
SCIENCE COLLEGE, NAGPUR

[Signature]
Principal

Principal
Dharampeth M.P. Deo Memorial
Science College, NAGPUR



DHARAMPETH M. P. DEO MEMORIAL SCIENCE COLLEGE,
North Ambazari Road, Near Ambazari Lake, Nagpur- 440033

DATA VALIDATION & VERIFICATION (DVV)

27)	Monali D. Kalamkam	8379824574	MonaliKalamkam46@gmail.com	Monali
28)	Nutan Mankam	7058693708	Nutanmankam1425@gmail.com	Nutan
29)	Saloni C. Landge	9699703706	Salonilandge74@gmail.com	Landge
30)	Rushikesh B. Hambarde	9028225874	rushikeshhb918@gmail.com	Rushikesh
31)	Deepak M. Tiwari	9175784046	Deepaktiwari2086@gmail.com	Deepak
32)	Aditya S. Gosavi	9158948313	Adityagosavi71@gmail.com	Aditya
33)	Lavesh P. Patil	9309902389	LaveshPatil1234@gmail.com	Patil
34)	Tanmay P. Tewari	9370144756	tanmaytewar2011@gmail.com	Tewari
35)	Deepak D. Dhakne	8459167742	ddhakne9786@gmail.com	Dhakne
36)	Vivek S. Sah	9923963071	Viveksah1893@gmail.com	Sah
37)	Prityanshu D. Yadav	9970192409	PrityanshuD77@gmail.com	Prityanshu
38)	Pooja C. Patil	8766659712	PoojaPatil2006@gmail.com	Patil
39)	Shubha Tiwari	9975452559	ShubhaTiwari123@gmail.com	Shubha
40)	Nitin Rajbhar	9082360041	nitinraj2122@gmail.com	Rajbhar
41)	Satish Malharani	7821097917	Satishmalhar25@gmail.com	Malharani
42)	Sagar Bunothe	7875187455	Sagarbunoth66@gmail.com	Bunothe

Signature of:

Programme in charge

COORDINATOR
INTERNATIONAL ASSURANCE C.T.I.
DHARAMPETH, M. P. DEO MEMORIAL &
SCIENCE COLLEGE, NAGPUR

Principal
Principal
Dharampeth M.P. Deo Memorial
Science College, NAGPUR



DHARAMPETH M. P. DEO MEMORIAL SCIENCE COLLEGE,
North Ambazari Road, Near Ambazari Lake, Nagpur- 440033

DATA VALIDATION & VERIFICATION (DVV)

10	Divyani Zangade	9022866318	divyanizangade@gmail.com	L. Zangade
20	Jankvi Kismapure	7058235243	jankvikismapure@gmail.com	Kismapure
30	Nisha Kosankar	9890996645	nishakosankar333@gmail.com	Nisha Kosankar
40	Vaidhvee B. Gorgal	750790778	gorgalv@gmail.com	V. Gorgal
50	Pranali R. Dehankar	8767581278	pdehna@gmail.com	Pranali R. Dehankar
60	Chyavul. D. Sawaykar	9921652613		Chyavul. D. Sawaykar
70	Shrutika S. Kaware	9049258171	shrutikaware142@gmail.com	Shrutika S. Kaware
80	Sumanandi S. Meshram	9281968933	sumanandimeshram@gmail.com	Sumanandi S. Meshram
90	Tejaswini K. Thakre	9356009926	thakretejaswini@gmail.com	Tejaswini K. Thakre
100	Bhumika V. Thakre	7218247917	BhumikaThakre55@gmail.com	Bhumika V. Thakre
110	Kurmi V. Bodge	8764086538	bodge834@gmail.com	K. Bodge
120	Shravya P. Dhurve	8421877898	shravyadhurve@gmail.com	Shravya P. Dhurve
130	Mirakshi S. Sonwane	7058423976	sonwanekhushi2@gmail.com	Mirakshi S. Sonwane
140	Ishika D. Kale	8830858196	ishikakale2476@gmail.com	Ishika D. Kale
150	Pratiksha S. Thakre	9322204869	pratikshathakre@gmail.com	Pratiksha S. Thakre
160	Akansha G. Upadhyay	8788739604		Akansha G. Upadhyay

Signature of:

Program In-charge

COORDINATOR
INTERNAL QUALITY ASSURANCE CELL
DHARAMPETH, M. P. DEO MEMORIAL &
SCIENCE COLLEGE, NAGPUR

Principal
Dharampeth M.P. Deo Memorial
Science College, NAGPUR



DHARAMPETH M. P. DEO MEMORIAL SCIENCE COLLEGE, NAGPUR
INTERNAL QUALITY ASSURANCE CELL (IQAC)

Activity Report

Date: 24/11/2022

Name of Organizing Department or Committee: Microbiology Department

Name of the activity: 'Microbiology Literacy Day

Suggested CRITERION point if any: Criterion II and V

Date of Activity: 22nd Nov 2022

Place of Activity: Laboratory of Microbiology

Name of Guest Speaker/s or Judge/s or Chief Guest/s if any: Guest Speaker- Dr Kekatpure

Title of the Activity: organized 'Microbiology Literacy Day' program for school students.

Number of Participants: 180 (school students) / college participants - 78

Name of the Teacher In-charge / Convener: Dr. Vidya R. Kathoke

Names of other Committee Members / Staff: Dr. Vaishali Pimple, Dr. Pratiksha Pohekar, Ms. Diksha Zade

OUTCOME of the Activity with respect to mission vision of the institute and or academics:

This was new initiative to develop awareness of microbiology amongst school students and create their interest towards science field also gave them newer learning experience to make whatever they have learnt in school a concrete knowledge.

Activity with newspaper coverage any:



Prof. Pitambar Humane
IQAC Coordinator

Dr. Vidya R. Kathoke
Name & Signature of Teacher In-charge

Dr. Akhilesh Peshwe
Principal



DHARAMPETH M. P. DEO MEMORIAL SCIENCE COLLEGE, NAGPUR
INTERNAL QUALITY ASSURANCE CELL (IQAC)

Activity Report

Date: 24/11/2022

Name of Organizing Department or Committee: Microbiology Department

Name of the activity: 'Microbiology Literacy Day

Suggested CRITERION point if any: Criterion II and V

Date of Activity: 22nd Nov 2022

Place of Activity: Laboratory of Microbiology

Name of Guest Speaker/s or Judge/s or Chief Guest/s if any: Guest Speaker- Mr. Ratnakar Kekatpure, Shri. Mangeshji Phatak and Principal Dr. Akhilesh Peshwe.

Title of the Activity: organized 'Microbiology Literacy Day' program for school students.

Number of Participants: 180 School Children / College participants (68)

Name of the Teacher In-charge / Convener: Dr. Vidya R. Kathoke

Names of other Committee Members / Staff: Dr. Vaishali Pimple, Dr. Pratiksha Pohekar, Ms. Diksha Zade, Mrs. Sonali Kumarwar

OUTCOME of the Activity with respect to mission vision of the institute and or academics: The students of Sem I, III & V involved in explanation of models, charts to school children. They enjoyed explanation of models, charts.

This was new initiative to develop awareness of microbiology amongst school students and create their interest towards science field also gave them newer learning experience to make whatever they have learnt in school a concrete knowledge.

Activity with newspaper coverage any:



Prof. Pitambar Humane

Dr. Vidya R. Kathoke
Name & Signature of Teacher In-charge

Dr. Akhilesh Peshwe

78 students



DHARAMPETH M. P. DEO MEMORIAL SCIENCE COLLEGE,
North Ambazari Road, Near Ambazari Lake, Nagpur- 440033

DATA VALIDATION & VERIFICATION (DVV)

BSC-PART 1

Name of the Programme : Microbiology Literacy Programme for School Children. (Model presentors)
 Date of the Programme : 22/11/2022 (Students who demonstrated model to school children)
 Name of Chief Guest if any : _____
 Name of Guest Speaker if any : _____

Sr. No.	Name of the Participant	Mobile Number	E-mail Id	Signature
1.	Pavindra M. Khadse	8007198273	khadsepavindra892@gmail.com	
2.				
3.	Umang Wauthi	9322428500	umangwauthi@gmail.com	
4.	Mansul A. Chaudhary	9520028604	mansulchaudhary2021@gmail.com	
5.	Geeta R. Bhojare	9668935876	geetarbhojare34@gmail.com	
6.	Dhanashree Newase	9359909913	dhanashreenewase78@gmail.com	
7.	Shruya A. Jha	8983236002	Sangeetajha0303@gmail.com	
8.	Riya A. Singh	9595649831	Riya0307@gmail.com	
9.	Katika M. Deshmukh	9649720960	katikamand20@gmail.com	
10.	Siddhi B. Tiwari	8087143695	siddhitiwari0721@gmail.com	

Signature of:

Programme In-charge

IQAC Coordinator

Principal
Dharampeth M. P. Deo Memorial
Science College, Nagpur



DHARAMPETH M. P. DEO MEMORIAL SCIENCE COLLEGE,
North Ambazari Road, Near Ambazari Lake, Nagpur - 440033

DATA VALIDATION & VERIFICATION (DVV)

11)	Raj N. Meshram	9529927031	rajmeshram1990@gmail.com	Raj
12)	Vaidehi P. Thate	7558499191	vaidehi.thate11@gmail.com	Vaidehi
13)	Neha L. Wanjarai	9373832266	nehawanjarai233@gmail.com	Neha
14)	Nikhil B. Rai	7058628289	nikhil1113@gmail.com	Nikhil
15)	Nisha -v. Pardley	8605291390	Abhiket5685@gmail.com	Nisha
16)	Yagita R. Denge	7058437240	yagitadenge@gmail.com	Yagita
17)	Shruti Channakara	7120933263	shrutichannakara@gmail.com	Shruti
18)	Arya Dhoke	9011681628	aryanambate21@gmail.com	Arya
19)	Jeet Parthi	7020215431	jeetparthi11@gmail.com	Jeet
20)	Anshul Kirnapure	9284067169	anshulkirnapure55@gmail.com	Anshul
21)	Shrawanika L. Umcar	9284249534	shrawanikumar12@gmail.com	Shrawanika
22)	Komalika Chaudhari	9322033866	KomalikaChaudhari13@gmail.com	Komalika
23)	Arnav Borkar	9168538614	ArnavBorkar13@gmail.com	Arnav
24)	Privanshu ete Raut	9322725233	PrivanshuRaut@gmail.com	Privanshu
25)				
26)				

Signature of:

Akathoke
Programme In-charge

Deptt. of Microbiology
Dharampeth M. P. Deo Memorial Science College

IQAC Coordinator

Principal
Dharampeth M. P. Deo Memorial Science College



DHARAMPETH M. P. DEO MEMORIAL SCIENCE COLLEGE,
North Ambazari Road, Near Ambazari Lake, Nagpur- 440033

DATA VALIDATION & VERIFICATION (DVV)

BSc - PART 2 (Model presentation)

1)	Vaishnavi Kapse	8983751089	VaishnaviKapse@gmail.com	Vaishnavi
2)	Suruti Longange	8390516511	SurutiLongange@gmail.com	Suruti
3)	Shital Bankar	7758055139	ShitalBankar20@gmail.com	Shital Bankar
4)	Pratiksha Naugbore	8623033760	Pratiksha56@gmail.com	P. Naugbore
5)	Kalyani Shahare	9307046378	ShahareKalyani5@gmail.com	Kalyani
6)	Nikita Bhave	9860159628	NikitaBhave23@gmail.com	Nikita
7)	Chirayu Dalas	8010135012	Chirayudalas22@gmail.com	Chirayu
8)	Sagar S. Rawane	9975466974	SagarRawane577@gmail.com	Sagar
9)	Vaibhav A. Malewar	8767832219	Vaibhavamalewar7@gmail.com	Vaibhav
10)	Ashina R. Sheikh	8080083983	ashinashikh913@gmail.com	Ashina
11)	Gauri A. Raut	9767875447	gauriaut2003@gmail.com	Gauri
12)	Ketaki R. Kulkarni	9112759066	ketakikulkarni1@gmail.com	Ketaki
13)	Prachal M. Meshkare	7028725505	Prachalmeshkare4@gmail.com	Prachal
14)	Smruti M. Vaidya	8856909764	SmrutiVaidya3@gmail.com	Smruti
15)	Anushkar G. Chandel	9145631751	Anushkar2010@gmail.com	Anushkar
16)	Mansi I. Mate	8468891807	mansi1912@gmail.com	Mansi

Signature of:

Program In-charge

Dept. of Microbiology
Dharampeth M. P. Deo Memorial
Science College, Nagpur.

IQAC Coordinator

Principal



DHARAMPETH M. P. DEO MEMORIAL SCIENCE COLLEGE,
North Ambazari Road, Near Ambazari Lake, Nagpur- 440033

DATA VALIDATION & VERIFICATION (DVV)

17.	Sakshi S Moshram	9145355733	sakshimoshram20@gmail.com	Sakshi
18.	Jagreeti D. Wankar	7447366023	jagreeti.d.wankar@gmail.com	Jagreeti
19.	Juhi S Chaudhari	8609248344	chaudharijuhi19@gmail.com	Juhi
20.	Prayal-S. bhoyar	8010434634	Prayal8738@gmail.com	Prayal
21.	Shubham Bisen	7448289544	shubhamatbisn@gmail.com	Shubham
22.	Aniket Kulkade	7709629106	aniketkulkade6@gmail.com	Aniket
23.	Vaishnavi Lakhe	8669594869	chhakuli.lakhe53@gmail.com	Vaishnavi
24.	Sheewani A. Warkhede	7058368837	sheewaniwarkhede@gmail.com	Sheewani
25.	Surabhi R. Pardhe	7887516628	surabhipardhe@gmail.com	Surabhi
26.	Niket Thakur	7378899037	Niketthakur26@gmail.com	Niket
27.	Kalpana Suhagpure	9579236712	kalpanasuhagpure@gmail.com	Kalpana
28.	Siddhanta Hikkane	9579092931	siddhantahikkane@gmail.com	Siddhanta
29.	Anjali Mishra	9325606519	anjali.mishra.615@gmail.com	Anjali
30.	Rupesh Bhatre	9579092931	Rupeshbhatre4012@gmail.com	Rupesh
31.	Prashant Poosa Itankar	9156973252	prashantitankar987@gmail.com	Prashant

Signature of:

Programme In-charge

IQAC Coordinator

Principal



DHARAMPETH M. P. DEO MEMORIAL SCIENCE COLLEGE,
North Ambazari Road, Near Ambazari Lake, Nagpur- 440033

BSc - PART 3
BSc - PART 2

DATA VAUDATION & VERIFICATION (DVV)

32	Tina Girjanan Rahangdale	9921776769	tinac@hangdale@gmail	<u>Tahangdale</u>
33	Urmila Vijay Bandre	9370673867	bandreurmila.2000@gmail.com	<u>Ubandre</u>
34	Shyamal Dnyaneshwar Narse	9765973998	Shyamalnarse@gmail.com	<u>Narse</u>
35	Vaibhavi Amas Shende	8080640782	Vaibhavishende97@gmail.com	<u>V.A. Shende</u>
36	Dhanshree Newalkar	9856516280	DhanshreeD@gmail.com	<u>Dhanshree</u>

Signature of:

Dhanshree
Programme in charge

IQAC Coordinator

Principal
Dharampeth M. P. Deo Memorial
Science College, Nagpur



DATA VALIDATION & VERIFICATION (DVV)

BS: - PART 3 (Model presentors)

1	Vaishnavi .R. Lakhe	8669594864	chhatakuli.lakhe@gmail.com	@lakhe
2	Krushnali S. Kedu	8625854995	krushnalikedu14@gmail.com	Badye
3	Shiwani S.R. Dwoivedi	8855900546	shiwani.dwoivedi.4@gmail.com	Shiwani
4	Sanskriti S. Panchbhawe	7447613185	sanskritipanchbhawe@gmail.com	Sanskriti
5	Samiksha N. Kunderkar	9145253759	samikshakunderkar@gmail.com	Kunderkar
6	Samiksha R. Chaudhari	7517090406	chaudharisamiksha20@gmail.com	Samiksha
7	Anjali R. Pali	7498107109	paliangiditika@gmail.com	Anjali
8	Arushi B. Wale	8530778433	arushiwale2001@gmail.com	@Arushi Wale
9	Sayli S. Lakhade	9356413804	sayalilakhade2910@gmail.com	Lakhade
10	Suman .A. Singh	7249465307	summissumansingh3@gmail.com	Suman
11	Madhura Bhondwe	8767484914	madhuraabhondwe@gmail.com	Madhura
12	Bhumika D. Chedge	8830391103	bhumikadchedge@gmail.com	Bhumika
13	Ayushi Shukla	9373668043	ayushishukla2011@gmail.com	Ayushi
14	Rinam C. Wankhede	8010966529	wankhede.rinam@gmail.com	Rinam
15	Shreyansh S. Naitwar	7447844189	shreyanshnaitwar1@gmail.com	Shreyansh
16	Vivek Waturwagh	8956482591	vivekwaturwagh@gmail.com	Vivek

Signature of:

V. K. Kulkarni
Programme in-charge

IQAC Coordinator

Principal
Dharampeth M. P. Deo Memorial
Science College, Nagpur



DHARAMPETH M. P. DEO MEMORIAL SCIENCE COLLEGE, NAGPUR

INTERNAL QUALITY ASSURANCE CELL (IQAC)

Activity Report

Date: 22nd November 2022

Name of Organizing Department or Committee: Electronics Department

Name of the Activity : Seminar(NEP)

Suggested CRITERION point if any: Suggested criteria II

Date of Activity: 22nd November 2022

Place of Activity : Electronics Lab

Name of Guest Speaker/s or Judge/s or Chief Guest/s if any : Not applicable

Title of the Activity: Seminar

Based on Unit : 2,4 & 4(Paper I & II)

Class : Semester V

Number of Participants: 22

Name of the Teacher In-charge / Convener: Mrs. Leena P. Thakare

OUTCOME of the Activity with respect to mission vision of the institute and or academics:

Different topics were taken by the students from the syllabus and presentation was given in the Electronics Lab. Questions were asked after the presentation.



Prof. Varsha Y. Rangari

Head of the Department

Prof. Pitambar Humane

IQAC Coordinator

CO ORDINATOR

**INTERNAL QUALITY ASSURANCE CELL
DHARAMPETH, M. P. DEO MEMORIAL &
SCIENCE COLLEGE, NAGPUR**

Dr. Akhilesh Peshwe

**Principal
Principal
Dharampeth M.P. Deo Memorial
Science College, Nagpur.**



Dharampeth M. P. Deo Memorial Science College,
Nagpur

Electronics Department
Semester V - (2022-23)

Seminar

Date : 22/11/2022

Sr. No	Name of Student	Topic	Signature	Date
1.	Bhavesh Maske	Optical fiber communication	Bhavesh M.	22/11/22
2.	Sakshi Hiwarkar	Mobile communication	Sakshi	22/11/22
3.	Abhijeet Mankar	Satellite communication	Abhijeet	22/11/22
4.	Pratik Ingle	Cellular system operation		
5.	Soniya Chaniya	Digital communication		
6.	Megha Bisen	Kepler's law	Megha	22/11/22
7.	Samiksha Tabhane	Geostationary Satellite	Samiksha	22/11/22
8.	Pratiksha Umare	Transponder	Pratiksha	22/11/22
9.	Ankita Sonwane	VSAT	Ankita	22/11/22
10.	Kiran Waghade	Laser Diode	Kiran Waghade	22/11/22
11.	Riddhi Rajkarne	Low Earth Orbit	Riddhi	22/11/22
12.	Tanmay Gadam	8085 Architecture	T.S. Gadam	22/11/22
13.	Rani Kokate	8255	Rani Kokate	22/11/22
14.	Sagar Sonwane	Medium earth orbit	Sagar	22/11/22
15.	Aarti Singh	FSK	Aarti Singh	22/11/22
16.	Sakshi Huddar	ASK	Sakshi	22/11/22
17.	Pratham Sonar	Stack printer	Pratham Sonar	22/11/22
18.	Nikhil K. Jankar	[ME O]	Nikhil	22/11/22
19.	Mukund S. Hood	mobile communication	M Hood	22/11/22
20.	Mahesh P. Maske	Digital communication	Mahesh	22/11/22
21.	Rujal L. Rohad	Losses in optical fiber	Rujal	22/11-22
22.	Saurabh P. Sharma	PSK	Saurabh	22-11-22



DHARAMPETH M. P. DEO MEMORIAL SCIENCE COLLEGE, NAGPUR

Department of Electronics

Semester III- (2022-23)

SEMINAR

Sr. No.	Student Name	Mobile No.	Email ID
1	Aasmin Abdulkhaliq Sheikh	8788490684	abdulkhalik563698@gmail.com
2	Janvi Ashok Kosarkar	8975756916	Janvikosarkar@gmail.com
3	Renuka Vishal Lande	7719951401	renukalande220@gmail.com
4	Unnatitai Chatrapal Chopde	9022627617	unnatichopde2002@gmail.com
5	Mansi Dilip Nandanwar	7709322027	mansinandanwar19@gmail.com
6	Yash Ravindra Khedekar	7020829422	yashkhedekar5@gmail.com
7	Ankush Samma Gawade	7588194156	agawde5603@gmail.com
8	Saurav Komalprasad Uikay	9356088871	sauravuikey6@gmail.com
9	Tushar Wadhawe		
10	Pratham Ankush Sitkare	9022553288	prathamsitkare@gmail.com
11	Jay Anilbhai Patil	7385436956	jay.patil0326@gmail.com
12	Pawankumar Shivkumar Vishwakarma	7058408869	pawanvishwakarma67448@gmail.com
13	Urvashi Sunilrao Umathe	9527708361	pragatichaure01@gmail.com
14	Sadhana Mitaram Pardhi	9067539417	pradhishubhangi4@gmail.com
15	Bhagyarathi Ramvinay Pandey	9175302601	pandeybhagyarathi@gmail.com
16	Priyanka Shilanath Shah	7796385608	rs3347310@gmail.com
17	Durgesh Krishna Singh	7385310432	ds608531@gmail.com
18	Sakshi Vinod Kanade	8806934839	Sakshikanade326@gmail.com
19	Chetan Umashankar Bopche	9172484628	chetanbopche27@gmail.com
20	Aditya Ravindra Singh	8999323047	aditya8999singh@gmail.com
21	Sandip Lotan Funde	9067118437	sandipfundesmc@gmail.com
22	Rahul Ramesh Kawade	9359525716	kawaderahul042@gmail.com

Name & Signature of Teacher In-Charge

Prof. Pitambar Humane
IQAC Coordinator

CO ORDINATOR
INTERNAL QUALITY ASSURANCE CELL
DHARAMPETH M. P. DEO MEMORIAL &
SCIENCE COLLEGE, NAGPUR

Name & Signature of Head of the
Department

Dr. Varsha V. Rangari
Professor & Head
Department of Electronics
Dharampeth M.P. Deo Memorial
Science College, Nagpur

Dr. Akhilesh Peshwe
Principal
Dharampeth M.P. Deo Memorial
Science College, Nagpur.



DHARAMPETH M. P. DEO MEMORIAL SCIENCE COLLEGE, NAGPUR

INTERNAL QUALITY ASSURANCE CELL (IQAC)

Activity Report

Date: 22nd & 23rd November 2022

Name of Organizing Department or Committee: Electronics Department

Name of the Activity : Seminar(NEP)

Suggested CRITERION point if any: Suggested criteria II

Date of Activity: 22nd & 23rd 2022

Place of Activity : Electronics Lab

Name of Guest Speaker/s or Judge/s or Chief Guest/s if any : Not applicable

Title of the Activity: Seminar

Based on Unit : 2 & 4(Paper I & II)

Class : Semester III

Number of Participants: 22

Name of the Teacher In-charge/Convener: Mrs. Leena P. Thakare

OUTCOME of the Activity with respect to mission vision of the institute and or academics:

Different topics were taken by the students from the syllabus and presentation was given in the Electronics Lab.



Prof. Varsha V. Rangari

Head of the Department

Prof. Pitambar Humane

COORDINATOR
INTERNAL QUALITY ASSURANCE CELL
DHARAMPETH, M. P. DEO MEMORIAL &
SCIENCE COLLEGE, NAGPUR

Principal

Dharampeth M.P. Deo Memorial
Science College, Nagpur.



Dharampeth M. P. Deo Memorial Science College,
Nagpur

Electronics Department
Semester III - (2022-23)

Seminar

Date : 22/11/2022 & 23/11/2022

Sr. No	Name of Student	Topic	Signature	Date
1.	Aasmin Sheikh	Class A Power Amplifier	Aasmin Sheikh	22-11-22
2.	Janvi Kosarkar	Transistor biasing	Janvi Kosarkar	22/11/22
3.	Renuka Lande	Circuit Testing	Renuka Lande	22-11-22
4.	Unnati Chopde	Band pass Filter	Unnati Chopde	22/11/22
5.	Mansi Nandanwar	Different types of amplifiers	Mansi Nandanwar	22/11/22
6.	Yash Khedekar	First order low pass filter	Yash Khedekar	22/11/22
7.	Ankush Gawade	CE amplifier	Ankush Gawade	22/11/22
8.	Saurav Uikay	Stability Factor		
9.	Tushar Wadhawe	Cross over distortion		
10.	Pratham Sitkare	High pass butterworth filter	Pratham Sitkare	
11.	Jay Patil	Sample and Hold circuit	Jay Patil	22-11-22
12.	Pawankumar	PAM and PWM		
13.	Urvashi Umate	h-parameters		
14.	Sadhana Pardhi	Band Reject Filter	Sadhana Pardhi	22-11-22
15.	Bhagyarathi Pandey	Phase shift oscillator	Bhagyarathi Pandey	22.11.22
16.	Priyanka Shah	Wein bridge oscillator		
17.	Durgesh Singh	Crystal Oscillator		
18.	Sakshi Kanade	Complementary-symmetry Feedback power amplifier	Sakshi Kanade	22.11.22
19.	Chetan Bopche			
20.	Aaditya Singh	OPAMP parameters	Aaditya Singh	22.11.22
21.	Sanjeev Bunde	Clipper circuit	Sanjeev Bunde	22.11.22
22.	Rahul Kawade	Push-Pull amplifier	Rahul Kawade	22/11/22



DHARAMPETH M. P. DEO MEMORIAL SCIENCE COLLEGE, NAGPUR

Department of Electronics

Semester III- (2022-23)

SEMINAR

Sr. No.	Student Name	Mobile No.	Email ID
1	Aasmin Abdulkhaliq Sheikh	8788490684	abdulkhalik563698@gmail.com
2	Janvi Ashok Kosarkar	8975756916	Janvikosarkar@gmail.com
3	Renuka Vishal Lande	7719951401	renukalande220@gmail.com
4	Unnatitai Chatrapal Chopde	9022627617	unnatichopde2002@gmail.com
5	Mansi Dilip Nandanwar	7709322027	mansinandanwar19@gmail.com
6	Yash Ravindra Khedekar	7020829422	yashkhedekar5@gmail.com
7	Ankush Samma Gawade	7588194156	agawde5603@gmail.com
8	Saurav Komalprasad Uikay	9356088871	sauravuikey6@gmail.com
9	Tushar Wadhawe		
10	Pratham Ankush Sitkare	9022553288	prathamsitkare@gmail.com
11	Jay Anilbhai Patil	7385436956	jay.patil0326@gmail.com
12	Pawankumar Shivkumar Vishwakarma	7058408869	pawanvishwakarma67448@gmail.com
13	Urvashi Sunilrao Umathe	9527708361	pragatichaure01@gmail.com
14	Sadhana Mitaram Pardhi	9067539417	pradhishubhangi4@gmail.com
15	Bhagyarathi Ramvinay Pandey	9175302601	pandeybhagyarathi@gmail.com
16	Priyanka Shilanath Shah	7796385608	rs3347310@gmail.com
17	Durgesh Krishna Singh	7385310432	ds608531@gmail.com
18	Sakshi Vinod Kanade	8806934839	Sakshikanade326@gmail.com
19	Chetan Umashankar Bopche	9172484628	chetanbopche27@gmail.com
20	Aditya Ravindra Singh	8999323047	aditya8999singh@gmail.com
21	Sandip Lotan Funde	9067118437	sandipfundesmc@gmail.com
22	Rahul Ramesh Kawade	9359525716	kawaderahul042@gmail.com

Name & Signature of Teacher In-Charge

Prof. Pitambar Humane
IQAC Coordinator

CO ORDINATOR
INTERNAL QUALITY ASSURANCE CELL
DHARAMPETH M. P. DEO MEMORIAL &
SCIENCE COLLEGE, NAGPUR

Name & Signature of Head of the
Department

Dr. Varsha V. Rangari
Professor & Head
Department of Electronics
Dharampeth M.P. Deo Memorial
Science College, Nagpur

Dr. Akhilesh Peshwe
Principal
Dharampeth M.P. Deo Memorial
Science College, Nagpur.



DHARAMPETH M. P. DEO MEMORIAL SCIENCE COLLEGE, NAGPUR
INTERNAL QUALITY ASSURANCE CELL (IQAC)
Activity Report

Date: 22/11/2022

Name of Organizing Department or Committee: Microbiology Department

Name of the activity: NEP Activity

Suggested CRITERION point if any: Criterion II

Date of Activity: 22/11/2022

Place of Activity: Department of Microbiology

Name of Guest Speaker/s or Judge/s or Chief Guest/s if any: Guest Speaker - Nil

Title of the Activity: Crossword Puzzle on Chromatography

Number of Participants: 25

Name of the Teacher In-charge / Convener: Dr. Mrs Vaishali Pimple

Names of other Committee Members: Nil

OUTCOME of the Activity with respect to mission vision of the institute and or academics:

Students understood the applications of electrophoresis and chromatography.

Students understood the meaning of certain terms associated with chromatography.

Activity with newspaper coverage any:

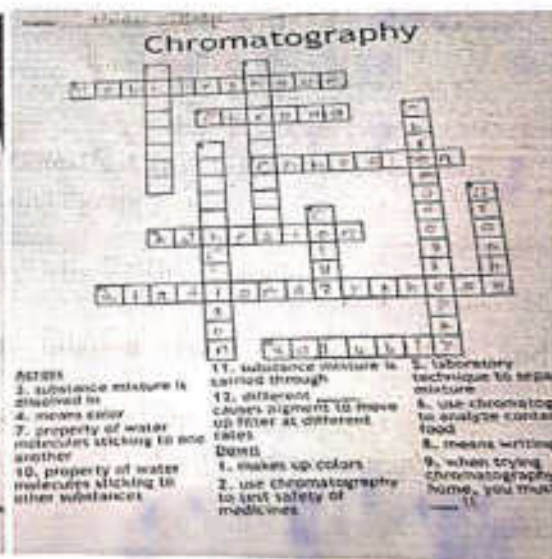

Name & Signature of Teacher In-charge

Prof. Pitambar Humane
IQAC Coordinator

CO ORDINATOR
INTERNAL QUALITY ASSURANCE CELL
DHARAMPETH, M. P. DEO MEMORIAL &
SCIENCE COLLEGE, NAGPUR

Dr. Akhilesh Peshwe
Principal

Dharampeth M.P. Deo Memorial
Science College, Nagpur.

Name: Handini Hudge

Date: _____

Chromatography

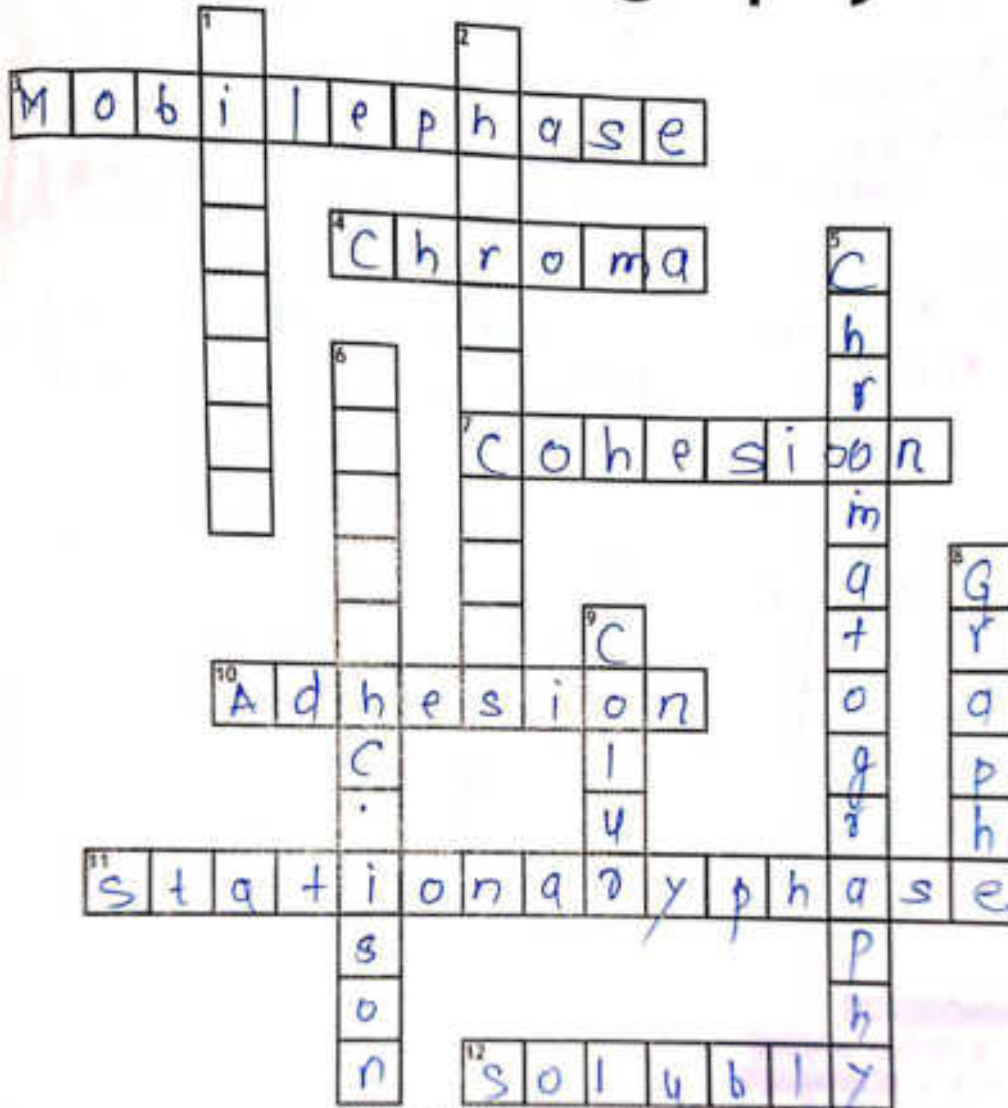

Across

- 3. substance mixture is dissolved in
- 4. means color
- 7. property of water molecules sticking to one another
- 10. property of water molecules sticking to other substances

11. substance mixture is carried through

12. different _____ causes pigment to move up filter at different rates

Down

- 1. makes up colors
- 2. use chromatography to test safety of medicines

5. laboratory technique to separate mixture

6. use chromatography to analyze contents of food

8. means writing

9. when trying chromatography at home, you must include _____ !!

Sem V

P.T.



DHARAMPETH M. P. DEO MEMORIAL SCIENCE COLLEGE,
North Ambazari Road, Near Ambazari Lake, Nagpur-440033

DATA VALIDATION & VERIFICATION (DVV)

Name of the Programme : Crossword puzzle in chromatography B.C Sem V

Date of the Programme : 22/11/22

Name of Chief Guest if any : Nil

Name of Guest Speaker if any : Nil

Sr. No.	Name of the Participant	Mobile Number	E-mail Id	Signature
1	Anjali B. Pali	7498102109	pallanjali246@gmail	
2	Nandini Suresh Hodge	9370301679	nandinihdg116@gmail	
3	Vivek R. ...	9956482591	vivek...@gmail	
4	Bhargavi A. Sambane	7709403006	bhargavisambane@gmail.com	
5	Tshika S. Thakre	806907069	ishthakre20@gmail.com	
6	Shruti M. Paulan	9527988707	shruti.paulan001@gmail.com	
7	shreyansh S. Naitwar	7447844165	shreyanshnaitwar@gmail.com	
8	Samiksha N. Kundekar	9145253758	samikshakundekar@gmail.com	
9	Samiksha R. Chaudhari	7577090406	chaudhari.samiksha20@gmail.com	
10	Ayushi Shukla	9373668043	ayushishukla2811002	

Signature of:

Programme In-charge

IQAC Coordinator
INTERNAL QUALITY ASSURANCE CELL
DHARAMPETH M. P. DEO MEMORIAL &
SCIENCE COLLEGE, NAGPUR

Principal
Dharampeth M. P. Deo Memorial
Science College, Nagpur



DHARAMPETH M. P. DEO MEMORIAL SCIENCE COLLEGE,
North Ambazari Road, Near Ambazari Lake, Nagour. 440013

DATA VALIDATION & VERIFICATION (DVV)

11.	Anurag S. Wde	8530778433	anuragwde200@gmail.com (Anurag)
12.	Madhura U. Bhondare	8767484914	MadhuraBhondare@gmail.com (Madhura)
13.	Krushali S. Kede	8625854995	krushalishinde@gmail.com (Krushali)
14.	Bhumi D. Chedje	8830391103	bhunikachedje@gmail.com (Bhumi)
15.	Karishma S. Bamsel	7389812507	karishmabamsel@gmail.com (Karishma)
16.	Rashmi M. Babsal	9325853408	Rashmi2018bh@gmail.com (Rashmi)
17.	Neha J. Chandekar	9310570893	nehachandekar216@gmail.com (Neha)
18.	Anika R. Bhojave	8758031173	Anikabhojave@gmail.com (Anika)
19.	Manali S. Shinde	72496387434	manalishinde067@gmail.com (Manali)
20.	Sayli S. Lokhande	9356413804	saybilokhande2911@gmail.com (Sayli)
21.	Isha B Gupta	9373289849	ishabgupta@gmail.com (Isha)
22.	Aisha Sakhasuani	9405197802	aishasakhasuani@gmail.com (Aisha)
23.	Kaushti Bhagat	858964947	kaushtibhagat@gmail.com (Kaushti)
24.	Dhanjani V. Dandae	9325473319	dandaidhanjanis@gmail.com (Dhanjani)
25.	Ananti A. Chaphekar	7875173847	anantia11@gmail.com (Ananti)

Signature of:



DHARAMPETH M. P. DEO MEMORIAL SCIENCE COLLEGE, NAGPUR

INTERNAL QUALITY ASSURANCE CELL (IQAC)

Activity Report

Date: 22-11-2022

Name of Organizing Department or Committee: Department of Statistics.

Name of the activity: Histogrammic representation of students marks.

Suggested CRITERION point if any:

Date of Activity: 22 November 2022

Place of Activity: Statistics lab

Name of Guest Speaker/s or Judge/s or Chief Guest/s if any:

Title of the Activity: Histogrammic representation of students marks.

Number of Participants: 23

Name of the Teacher: Durga hingwe

Names of other Committee Members / Staff: N.A.

OUTCOME of the Activity with respect to mission vision of the institute and or academics:

In this activity, Grouped data are often represented graphically by histograms. Learning outcomes, Display data graphically and interpret graphs and lead to better test results. Each rectangle bar depicts some sort of data and all the reactangle are adjacent. The heights of rectangles are proportional to corresponding frequencies of similar as well as for different classes.

Activity with newspaper coverage if any: No

Activity data save in PC of: Department of Statistics

Prof. Pitambar Humane
IQAC Coordinator

CO ORDINATOR
INTERNAL QUALITY ASSURANCE CELL
DHARAMPETH M. P. DEO MEMORIAL &
SCIENCE COLLEGE, NAGPUR

Name & Signature of Teacher In-charge

Dr. Akhilesh Peshwe
Principal

Principal
Dharampeth M.P. Deo Memorial
Science College, Nagpur.



DHARAMPETH M. P. DEO MEMORIAL SCIENCE COLLEGE NAGPUR

Department of Statistics

Class: B.Sc. Sem.-I

NEP ACTIVITY

Paper- II

Unit- IV

Name of the Teacher: Durga. C. Hingwe

Date: 22-11-2022

Title of Activity: Histogrammatical representation of student's marks

Sr. No.	Name of Student	Batch	Mobile No.	Email ID	Signature
1	Dinyani V. Zagade	F2	9022866318	dinyanizagade@gmail.com	<u>Dinyani</u>
2	Janvi V. Ichode	F2	7345066634	JanviIchode@gmail.com	<u>Janvi</u>
3	Pranali R. Dehanikar	F2	8767581278	Pdehna@gmail.com	<u>Pranali</u>
4	Nisha S. Kasarbari	F2	9990996645	nishakasarbari33@gmail.com	<u>Nisha</u>
5	Utkasha S. Ingale	F2	7499159178	utkashaingale3@gmail.com	<u>Utkasha</u>
6	Vidya Lohi	F2	7020965219	Vidyalohi8@gmail.com	<u>Vidya</u>
7	Sakshi Mishra	F2	9579889315	Sakshimishra39683@gmail.com	<u>Sakshi</u>
8	Tanvi Laibey	F2	8446570539	Tanvilaibey@gmail.com	<u>Tanvi</u>
9	Rutika Yadav	F2	8446085943	yadavrutika436@gmail.com	<u>Rutika</u>
10	Mohit Khindekar	F2	907328357	mohitkhindekar@gmail.com	<u>Mohit</u>
11	Veena Borikar	F2	9372016921	veena.borikar.19@gmail.com	<u>Veena</u>
12	Janvi Jage	F2	7385060871	Janvijage08@gmail.com	<u>Janvi</u>
13	Pranali Aupta	F2	7020063377	rg991537@gmail.com	<u>Pranali</u>
14	Jaguti Fullkarwar	F2	8767811307	JagutiFullkarwar@gmail.com	<u>Jaguti</u>
15	Sonia Niwal	F2	7058425021	niwalsonia70@gmail.com	<u>Sonia</u>
16	Chetna Buiwle	F2	806342468	buiwlechetna@gmail.com	<u>Chetna</u>
17	Devashi Kakole	F2	9021944265	kakoledevashi@gmail.com	<u>Devashi</u>
18	Janvi A. Kinnapure	F2	7058235243	janvikinnapure@gmail.com	<u>Janvi</u>
19	Prachya - Tripude	F2	8010362232	prachyatripude9145@gmail.com	<u>Prachya</u>
20	Vivek S. Sah	F1	9923763071	vivek.sah1878@gmail.com	<u>Vivek</u>
21	Nayan N. Matthure	F1	7841870747	nayan.n.matthure74@gmail.com	<u>Nayan</u>
22	Shilpa Doolipande	F2	9130091540	shilpadoolipande2004@gmail.com	<u>Shilpa</u>
23	Varsha L. Turkar	F2	9373650950	varshaturkar4586@gmail.com	<u>Varsha</u>

Durga C. Hingwe
Signature of Teacher

Durga C. Hingwe
Teacher Incharge



Activity Report

Date: 23/11/2022

Name of Organizing Department or Committee: Chemistry

Name of the activity: Poster and Model competition

Suggested CRITERION point if any: Criteria II

Date of Activity: 22/11/ 2022

Place of Activity: Chemistry Department

Name of Guest Speaker/s or Judge/s or Chief Guest/s if any: Nil

Title of the Activity: Chemistry Syllabus based poster and Models

Number of Participants: 170

Name of the Teacher In-charge / Convener: Dr. Vaishali p. Meshram

Names of other Committee Members / Staff: Dr. Tanishq Chaudhary

OUTCOME of the Activity with respect to mission vision of the institute and or academics:

Student prepared the poster model which were based on syllabus of chemistry so they understood experience learning though the poster and model they have got the very clear idea about concept in chemistry and uses of phenol in medicinal industries, cosmati industries and many more uses of phenol

Activity with newspaper coverage if any: No

Activity data save in PC of: Chemistry

Note: Kindly share geotag photographs separately along with report on igac@fsc2022@gmail.com



Prof. Pitambar Humane
IQAC Coordinator

CO ORDINATOR
INTERNAL QUALITY ASSURANCE CELL
DHARAMPETH, M. P. DEO MEMORIAL &
SCIENCE COLLEGE, NAGPUR

Name & Signature of Teacher In-charge

Dr. Akhilesh Peshwe
Principal

PRINCIPAL
Dharampeth M.P. Deo Memorial
Science College, Nagpur-440035

Maharashtra adhyan mandir Gandhi nagar vidhyapeetha.



DHARAMPETH M. P. DEO MEMORIAL SCIENCE COLLEGE,
North Ambazari Road, Near Ambazari Lake, Nagpur- 440033

DATA VALIDATION & VERIFICATION (DVV)

Date :- 22/11/2022

Name of the Programme : Exhibition of Chemistry (Poster & Model competition)
Date of the Programme : 22/11/2022
Name of Chief Guest if any : -
Name of Guest Speaker if any : -

Sr. No.	Name of the Participant	Mobile Number	E-mail Id	Signature
1)	Daksha Takur			DAKSH
2)	Nishikha Sakhare			N.P. Sakhare
3)	Tajal Munjekar			Munjekar
4)	Anurath Ramesh			ANURATH
5)	Georav Bhupendra			GEORAV
6)	Aditya Balonakar			Aditya
7)	Lucky Dhoke			LUCKY
8)	Jyesh Sambh			Jyesh
9)	Aman Hatwar			Aman
10)	Sahil Mahale			Sahil

Signature of:

Programme In-charge

COORDINATOR
INTERNAL QUALITY ASSURANCE CELL
DHARAMPETH, M. P. DEO MEMORIAL &
SCIENCE COLLEGE, NAGPUR

Principal
PRINCIPAL
Dharampeth M.P. Deo Memorial
Science College, Nagpur-440033



DHARAMPETH M. P. DEO MEMORIAL SCIENCE COLLEGE,
North Ambazari Road, Near Ambazari Lake, Nagpur- 440033

DATA VALIDATION & VERIFICATION (DVV)

	Name	Mobile	E-mail	Sign
11	Ritesh Nebane			Ritesh
12	Tushar Raut			Tushar
13	Kunal Vikey			Kunal
14	Jyeshth Khadke			Jyeshth
15	Syshanant Yike			Syshanant
16	Jawan S. Musam			Jawan
17	Yash. S. Kumbhar			Yash
18	Uday C. Dandae			Uday
19	Mithlesh M. Bhajbhaje			Mithlesh
20	Nayan Nimade			Nayan
21	Ritesh Salame			Ritesh
22	Kunal Phulke			Kunal
23	Ashwin Sonwan			Ashwin
24	Santosh Radke			Santosh
25	Yogesh Ahire			Yogesh

Signature of:

Programme In-charge

CO ORDINATOR
INTERNAL QUALITY ASSURANCE CELL
DHARAMPETH, M. P. DEO MEMORIAL &
SCIENCE COLLEGE, NAGPUR

PRINCIPAL
* Dharampeth M.P. Deo Memorial
Science College, Nagpur-440033



DHARAMPETH M. P. DEO MEMORIAL SCIENCE COLLEGE,
North Ambazari Road, Near Ambazari Lake, Nagpur- 440033

DATA VALIDATION & VERIFICATION (DVV)

Name

Roll No.

email

Signature

	Name	Roll No.	email	Signature
26	Atalash Raut			Atalash
27	priya Ronge			priya
28	Krishiti Kokate			Krishiti
29	Manisha Katre			Manisha
30	Jijel			Jijel
31	Khushi Dongre			Khushi
32	Sonu Jawade			Sonu
33	सिद्धी नेवार			Sidhi
34	समीरणी हेम			समीरणी
35	Kuruli Raut			KRaut
36	Shivani massam			Shivani massam
37	Tanisha Ukey			Tanisha
38	Ragini Soneta			Ragini
39	RUCHI Kokarde			RUCHI Kokarde
40	करोली शोख			करोली शोख

Signature of:

Programme In-charge

COORDINATOR
INTERNAL QUALITY ASSURANCE CELL
DHARAMPETH, M. P. DEO MEMORIAL &
SCIENCE COLLEGE, NAGPUR

Principal

PRINCIPAL
Dharampeth M. P. Deo Memorial
Science College, Nagpur-440033



Dharampeth M. P. Deo Memorial Science College, Nagpur

Academic Session: 2018-2019

Name of Activity:

Maharashtra adhyan Mandal Gandhi nagar Vidyalyaya.

Sr. No.	Name of the Student	Signature	Contact No	Email-id
1	Shreya Ramteke	Shreya		
2	Vanshika Khandare	Vanshika	7058536592	
3	SAVSHI Talwarde	SAVSHI	9284068521	
4	Tanushree Sambharde	Tanushree	8446313756	
5	Tanvi Pandhore	Tanvi	8080166879	
6	Nandini Jambhik	nandini	9881820490	
7	Kiran Khandare	Kiran	7725878164	
8	Aashrini Dholekar	Aashrini	8552906845	
9	Nandini Senekar	Nandini	9527628657	
10	Suhani Meshram	Suhani	8668488591	
11	श्रेया तवारे	श्रेया		
12	Subarna Ulkey	Subarna	9172938660	
13	SUSHMA DHANJUNE	SUSHMA	9657801974	
14	Vaishnavi R. Kaurade	Vaishnavi	9579177029	
15	Pooja S. Sidam	Pooja	9373747003	
16				
17				
18				
19				
20				
21				
22				
23				
24				
25				
26				
27				
28				
29				
30				
31				
32				
33				
34				
35				

Teacher In-charge



Dharampeth M. P. Deo Memorial Science College, Nagpur

Date: 22/11/2022

Dharampeth Tarkunde

Academic Session: 2018-2019-
2022-2023

Name of Activity:

Sr. No.	Name of the Student	Signature	Contact No	Email-id
1	Shaywari Agarkar	[Signature]		
2	Tanvi S. Palle	[Signature]		
3	Mrunali B. Sonule	[Signature]		
4	Shrushti R. Shiwax	[Signature]		
5	Ragini Singh	[Signature]		
6	Manika Agnikotai	[Signature]		
7	Frupthi M. Tembhumnikar	[Signature]		
8	Aliya Khan	[Signature]		
9	Nafisa Shaikh	[Signature]		
10	Khushbu Palkar	[Signature]		
11	Jarvi Gautre	[Signature]		
12	Jalguni Raut	[Signature]		
13	Khushbu Gaurkar	[Signature]		
14	Bhaurti Tembhaer	[Signature]		
15	Sonali Yadav	[Signature]		
16	Tishha Kanade	[Signature]		
17	Yashasvi Nagdeve	[Signature]		
18	Muskan Bishe	[Signature]		
19	Ravina Chauragale	[Signature]		
20	Tarupti Dhane	[Signature]		
21	Greetanjali Lahare	[Signature]		
22	Sakshi Khodpe	[Signature]		
23	Nilima Sonawane	[Signature]		
24	Kuchita. Kulkarni	[Signature]		
25	Kaveri Kulk	[Signature]		
26	Pipari Tukde	[Signature]		
27	Shruti Pachode	[Signature]		
28	Riya Gawan de	[Signature]		
29	Pritya Mhasikar	[Signature]		
30	Hareesh Sahy	[Signature]		
31	Ajay Pandit	[Signature]		
32	Sanil Moon	[Signature]		
33	Paarvai Shah	[Signature]		
34	Gulshan Sulakhe	[Signature]		
35	Deward Bedgle	[Signature]		

[Signature]
Teacher In-charge

Tarkunde Dharampeth.



Dharampeth M. P. Deo Memorial Science College, Nagpur

Academic Session: 2018-2019

2021-2023.

Name of Activity:

Dharampeth Tankunde

Sr. No.	Name of the Student	Signature	Contact No	Email-id
1	Shriyash Gupta			
2	Nikhil Madame			
3	Rajwaj P. Meshram			
4	Mohit Agnihotri			
5	Rahul Dikare			
6	Laksh Rakhangadai			
7	Daksh P. Barhate			
8	gunesha V. Tharai			
9				
10				
11				
12				
13				
14				
15				
16				
17				
18				
19				
20				
21				
22				
23				
24				
25				
26				
27				
28				
29				
30				
31				
32				
33				
34				
35				

Teacher In-charge



Dharampeth M. P. Deo Memorial Science College, Nagpur

Academic Session: 2018-2019

Name of Activity:

Penmanship Senior College

Sr. No.	Name of the Student	Signature	Contact No	Email-id
1	Aditi Wable			
2	Vaishnavi Shende			
3	Mansi Gawai			
4	Shradha Warthi			
5	Dinesh Salame			
6	Sai Patil			
7	Jushal Lonare			
8	Ruchika Pale			
9	Sejal Patil			
10				
11				
12				
13				
14				
15				
16				
17				
18				
19				
20				
21				
22				
23				
24				
25				
26				
27				
28				
29				
30				
31				
32				
33				
34				
35				

Teacher In-charge



DHARAMPETH M. P. DEO MEMORIAL SCIENCE COLLEGE,
North Ambazari Road, Near Ambazari Lake, Nagpur- 440033

DATA VALIDATION & VERIFICATION (DVV)

Chemistry Exhibition

1)	Shrutika Kulkarni	9075232517	shrutika.kulkarni@gmail.com	Shrutika
2)	Kaustik Adtakhia	8530597159	Kaustik.adtakhia@gmail.com	Kaustik
3)	Nikita Ekre	7972190915	ecre.nikita@gmail.com	Nikita
4)	Pallavi Bhagat	9022654940	Pallavi2208@gmail.com	Bhagat
5)	Shivani Bhute	9302900209	bhuteshivani835@gmail.com	Bhute
6)	Sakshi Moon	7745827736	sakshim3090@gmail.com	Moon
7)	Megha Fulwar	8605399606	MeghaFulwar@gmail.com	Fulwar
8)	Khushi Aundhkar	8767279513	khushi.aundhkar@gmail.com	Khushi
9)	Tanmay Bhute	7697250831	tanmaybhute900@gmail.com	Tanmay
10)	Anshika Bhojane	8788031133	anshika	
10)	Aakash A. Sikdar	9175422051	Sikdarakash15@gmail.com	Aakash
11)	Vishal Kumar Singh	9610187228	singhvishal9602@gmail.com	Vishal
12)	Poojita R. Gupta	8267275149	Poojitagupta97@gmail.com	Poojita

Signature of:

Programme In-charge

COORDINATOR
INTERNET QUALITY ASSURANCE CELL
DHARAMPETH, M. P. DEO MEMORIAL &
SCIENCE COLLEGE, NAGPUR

Principal
Dharampeth M. P. Deo Memorial
Science College, Nagpur-440033



DHARAMPETH M. P. DEO MEMORIAL SCIENCE COLLEGE,
North Ambazari Road, Near Ambazari Lake, Nagpur- 440033

DATA VALIDATION & VERIFICATION (DVV)

1	Shruti M. Pawar	9527988707	shrutipawar0707@gmail.com	SPawar
2	Manish S. Gunde	9370329857	Manishgunde79@gmail.com	Mgunde
37	Tanmay Chaudhari	8600102341	tchudhari8600@gmail.com	Tan
47	Nandini Hodge	9370301679	nandinihodge17@gmail.com	NH
57	Laxmi Gunde	7758058514	laxmiguunde2008@gmail.com	Laxmi Gunde
67	Bhargavi Sambare	7709403806	bhargavisambar05@gmail.com	Bhargavi
77	Suraj S. Jadhav	8767435158	Surajshyamsajadhav82@gmail.com	SJadhav
87	Ishika S. Thakre	8010907009	Ishithakre22@gmail.com	Ishika
97	Senket Lode	7972085380	Senketlode123@gmail.com	Senket
107	Neha J. Chandreatre	9156873792	nehachandretrk916@gmail.com	NChandreatre
117	Ancita R. Bhoyat	8788031173	ancitabhoyat06@gmail.com	Ancita
127	Kaushikma Bansod	7389812507	Kaushikmbansod401@gmail.com	Kaushikma
137	Smriti M. Gaikwad	7385532705	smritigaikwad86935@gmail.com	Smriti

Signature of:

Programme In-charge

CO-ORDINATOR
INTERNAL QUALITY ASSURANCE CELL
DHARAMPETH, M. P. DEO MEMORIAL &
SCIENCE COLLEGE, NAGPUR

Principal
PRINCIPAL
Dharampeth M.P. Deo Memorial
Science College, Nagpur-440033



DHARAMPETH M. P. DEO MEMORIAL SCIENCE COLLEGE,
North Ambazari Road, Near Ambazari Lake, Nagpur- 440033

DATA VALIDATION & VERIFICATION (DVV)

Name of the Programme : Poster & Model Competition
Date of the Programme : 22/11/22
Name of Chief Guest if any : -
Name of Guest Speaker if any : -

Sr. No.	Name of the Participant	Mobile Number	E-mail Id	Signature
11	Poojwal. S. bhoyar	8010434634	Poojwalb38@gmail.com	
12	Aditya A. Mishra	7218484186	adityamishra3533@gmail.com	
13	Rupesh. C. Bhokre	8805887370	bhokrerupesh@gmail.com	
14	Vaishnavi R Naundhure	932043936	VaishnaviNaundhure@gmail.com	
15	Mansi D. Raut	7385114931	Mansirauf451@gmail.com	
16	Chhakuli. G. Wadikar	9325047907	chhakuwadikar@gmail.com	
17	Vaishnavi. R. Lakhe	8069594864	vaishnavilakhe@gmail.com	
18	Varsha R. Tiwari	8408097998	varshatiwari7716@gmail.com	
19	Shikha J. Yadav	7263881320	Shikha.yadav31@gmail.com	
20	Sushma G. Gurnule	9156231747	Sushmagurnule@gmail.com	

Signature of:

Programme In-charge

CO ORDINATOR
INTERNAL QUALITY ASSURANCE CELL
DHARAMPETH, M. P. DEO MEMORIAL &
SCIENCE COLLEGE, NAGPUR

PRINCIPAL
Dharampeth M.P. Deo Memorial
Science College, Nagpur-440033



DHARAMPETH M. P. DEO MEMORIAL SCIENCE COLLEGE,
North Ambazari Road, Near Ambazari Lake, Nagpur- 440033

DATA VALIDATION & VERIFICATION (DVV)

Name of the Programme : Poster and Model Competition - BSc Sem III
Date of the Programme : 22/11/2022
Name of Chief Guest if any : -
Name of Guest Speaker if any : -

Sr. No.	Name of the Participant	Mobile Number	E-mail Id	Signature
1	Dhanshree Y. Newalkar	9356516280	newalkardhanshree@gmail.com	D. Newalkar
2	Shreya S. Bagde	8669883639	bagdeshreya78@gmail.com	S. Bagde
3	Shruti P. Masram	8308657972	shrutimasram01@gmail.com	Shruti
4	Riya V. Tardit	9370616353	tarditriya753@gmail.com	Riya
5	Yashashree P. Chande	9769008929	yashashreechande@gmail.com	P. Chande
6	Sumit S. Bhandarkar	8788212839	Sumitbhandarkar100@gmail.com	Sumit
7	Harsh S. Kodaye	9604677672	harshkodaye1001@gmail.com	H. Kodaye
8	Gangul L. Hadge	7972076671	gangulhadge@gmail.com	Gangul
9	Vaishnavi V. Gadge	9022976449	gadgevaishnavi@gmail.com	V. Gadge
10	Vivant V. Bhatnagar	8530455796	vivantbhatnagar23@gmail.com	V. Bhatnagar

Signature of: Dr. Y. S. Dahore

Programme In-charge: (Signature)

COORDINATOR
INTERNAL QUALITY ASSURANCE CELL
DHARAMPETH, M. P. DEO MEMORIAL &
SCIENCE COLLEGE, NAGPUR

Principal
Principal
Dharampeth M. P. Deo Memorial
Science College, Nagpur-440033

X

17

Nupur. M. Sharma 9322042259
 Darshan Madavi 883946119
 Juhi Chaudhari 8669248944
 Swati loncjedje 8390516512
 Vaishnavi Kapse 8983751081
 Nikita Kalle 9067324988
 Sejal. Lakhampal 9028877568
 Devanish D. Bisen 7767861231
 Kalyani Shahare 9307046378
 Sagar S. Bawane 9975460979
 Nidhi K. Misal 8805917268
 Yash. R. Bhojare 9689792728
 Aniket. V. Kulkade 7709620806
 Vaishali S. Nimje 9579993869
 Nikita S. Bhave 9860159628
 Bhumika V. Thakre 7218247917

nupursharma258@gmail.com
 darshanmadavi@rediffmail.com
 chaudharijuhi120@gmail.com
 Swatiloncjedje11@gmail.com
 vaishnavikapse05@gmail.com
 kallonikitas@gmail.com
 sejal.lakhampal@gmail.com
 Devanish Bisen 31car
 Shahare Kalyani S@gmail.com
 sagarshawane637@gmail.com
 Nidhimisal2003@gmail.com
 yashbhojare2212@gmail.com
 aniketv@gmail.com
 vaishalinimje2007@gmail.com
 nikitasbhave8@gmail.com
 Bhumika-thakre25@gmail.com

Nupur
Darshan
Juhi
Swati
Vaishnavi
Nikita
Sejal
Devanish
Kalyani
Sagar
Nidhi
Yash
Aniket
Vaishali
Nikita
Bhumika

Ananya R. Molyhaxe
 Kajal P. Nighat
 Gaurav P. Landge
 Shrutika R. Borkar
 Chetan Jadhav
 Twinkal Lokhande
 Pooja Hanbate
 Tina Rahangdale
 Sakshi M. Ingle
 Apurva Vernekar
 Shital Bankar
 Shital Kelzarkar
 Satyam Mishra
 Yash Bankar
 Jasraj Palival
 Shashank Pandey
 Tushar Atkari
 Rutik Gajbhiye
 Rushali Bhoskar
 Ritik M. Varma
 Dhammaprati Lale
 Mansi S. Fading
 Divya K. Hanote

7219218955
 937325062
 7767854087
 9067950845
 7058522146
 9149176609
 9156973292
 9921776769
 9067877594
 9623613911
 7758055139
 9373329723
 7798480275
 7083848519
 9270820325
 9988644686
 7840916581
 7620826960
 9573485357
 93567444234
 9975037356
 8787134686
 8605422901

ananyamolyhaxe1802@gmail.com
 kajalnighat2000@gmail.com
 gauravlandge5421@gmail.com
 shrutikaborkar4@gmail.com
 chetanjadhav78@gmail.com
 twinkallokhande14@gmail.com
 poojahanbate03987@gmail.com
 tinarahangdale@gmail.com
 anglesakshi703@gmail.com
 apurva.vernekar@gmail.com
 shitalbankar122@gmail.com
 shital2020kik@gmail.com
 satyamishraal@gmail.com
 yashbankar2002@gmail.com
 jasrajpalival42@gmail.com
 pandeyshashank912@gmail.com
 atkaritushar@gmail.com
 rutikgajbhiye@gmail.com
 rushalibhoskar@gmail.com
 ritikv929@gmail.com
 dhammaprati09@gmail.com
 mansifading2110@gmail.com
 divyaharotkot06@gmail.com

@anany
~~Kajal~~
 Gaurav
~~Shrutika~~
~~Chetan~~
 Twinkal
 Pooja
~~Tina~~
 Sakshi
 Apurva
 Shital
 Shital
 Satyam
 Yash
 Jasraj
 Shashank
 Tushar
 Rutik
 Rushali
 Ritik
 Dhammaprati
 Mansi
 Divya



DHARAMPETH M. P. DEO MEMORIAL SCIENCE COLLEGE, NAGPUR
DEPARTMENT OF COMPUTER SCIENCE
ACADEMIC SESSION: 2022-23

NOTICE

15th November 2022

All the students of **B.Sc.[SEM V]** are hereby informed that the Department of Computer Science, Dharampeth M.P.Deo Memorial Science College, Nagpur is going to organize Hands Training on creating Menus, Popup menus used in project development and handling database with different operation base on Unit III of **Paper I[Visual Basic Programming]** on **21st November 2022**. All the students must remain present and participate in this activity.

Venue : Computer Science laboratory
Time : 11.15am

PRINCIPAL
DHARAMPETH M.P. DEO
MEMORIAL SCIENCE COLLEGE
NAGPUR

Head, Department of Computer Science



DHARAMPETH M. P. DEO MEMORIAL SCIENCE COLLEGE, NAGPUR
INTERNAL QUALITY ASSURANCE CELL (IQAC)

Activity Report

Date: 30th November 2022

Name of Organizing Department or Committee: Computer Science Department

Name of the activity: Hands on Training

Suggested CRITERION point if any: Criteria V

Date of Activity: 29th November 2022

Place of Activity: Computer Science Laboratory

Name of Guest Speaker/s or Judge/s or Chief Guest/s if any: Nil

Title of the Activity: creating Menus, Popup menus used in project development and handling database with different operations for B.Sc. SEM V students on Paper I [Unit III]

Number of Participants: 27

Name of the Teacher In-charge / Convener: Dr.Mrs.Snehal Narale

Names of other Committee Members / Staff: Nil

OUTCOME of the Activity with respect to mission vision of the institute and or academics:

The objective of this program was to improve the individual's level of awareness and knowledge about the specific topic from their syllabus. Training program motivate the students to give their best performance. From such type of the training program students will be able to:

- Increase skill in one or more areas of expertise on the specific topic.
- It provides real-world experience by allowing the trainee students to get her hands directly on whatever she is learning, creating a sense of empowerment.
- It help the students to show their interest on kinaesthetic learning, where a student carries out physical activities rather than listening to a lecture
- It allows students to experiment with trial and error, learn from their mistakes, and understand the potential gaps between theory and practice.
- To enrich their minds in new ways.

Activity with newspaper coverage if any: Nil

Activity data save in PC of: Dr. Mrs. Snehal Narale's Laptop



Prof.Pitambar Humane
IQAC Coordinator
IQAC Co-ordinator
Dharampeth M.P. Deo Memorial
Science College, Nagpur-440033

Name & Signature of Teacher In-charge

Dr.Akhilesh Peshwe
Principal
Principal
Dharampeth M.P. Deo Memorial
Science College, Nagpur.



DHARAMPETH M. P. DEO MEMORIAL SCIENCE COLLEGE,
North Ambazari Road, Near Ambazari Lake, Nagpur - 440033

DATA VALIDATION & VERIFICATION (DVV)

Name of the Programme : Hands on Training menus, Pop up menus used in project
 Date of the Programme : 23/11/2022
 Name of Chief Guest if any : _____
 Name of Guest Speaker if any : _____

Sr. No.	Name of the Participant	Mobile Number	E-mail Id	Signature
1	<u>Abhi A. Rai</u>	<u>9855999509</u>	<u>amravnal1@gmail.com</u>	<u>Abhi</u>
2	<u>Geetanjali M. Lakshay</u>	<u>7058728070</u>	<u>geetanjali013@gmail.com</u>	<u>Geetanjali</u>
3	<u>Ku. Sujata. Dharmraj. Sonawane</u>	<u>9023135146</u>	<u>sujata05@gmail.com</u>	<u>Sujata</u>
4	<u>Somitksha P. Kharsase</u>	<u>9604473539</u>	<u>somitkshap@gmail.com</u>	<u>Somitksha P.</u>
5	<u>Pratiksha S. Chaudhari</u>	<u>7607317639</u>	<u>pratikshas@gmail.com</u>	<u>Pratiksha</u>
6	<u>Triangal D. Sonawankar</u>	<u>4385458510</u>	<u>triangal@gmail.com</u>	<u>Triangal</u>
7	<u>Ruditee S. Bhargava</u>	<u>96227832686</u>	<u>ruditee@gmail.com</u>	<u>Ruditee</u>
8	<u>Komal Kumbhakar</u>	<u>7620314869</u>	<u>komalk@gmail.com</u>	<u>Komal</u>
9	<u>Neha T. Bankar</u>	<u>8055477553</u>	<u>nehata@gmail.com</u>	<u>Neha</u>
10	<u>Krushika D. Dave</u>	<u>9890009034</u>	<u>k8855747@gmail.com</u>	<u>Krushika</u>

Signature of: _____

Programme In-charge

[Signature]

[Signature]

IQAC Coordinator
CO ORDINATOR

INTERNAL QUALITY ASSURANCE CELL
DHARAMPETH, M. P. DEO MEMORIAL

CHIEF, NACMPJ

Principal

[Signature]

Dharampeth M.P. Deo Memorial
Science College, Nagpur.



DHARAMPETH M. P. DEO MEMORIAL SCIENCE COLLEGE,
North Ambazari Road, Near Ambazari Lake, Nagpur - 440033

DATA VALIDATION & VERIFICATION (DVV)

11	Digo R Patil	7751452463	digopatil1985@gmail.com	Patil
12	Rishi R. Dhande	9329416413	rishidhande19@gmail.com	Dhande
13)	Abdul Gafar Aman Siddique	7666759578	abdulaman2511@gmail.com	Siddique
14)	Prathmesh Budhwe	9265262138	prathmeshbudhwe19@gmail.com	Budhwe
15)	Ashwin Kumar	7859479116	ashwin.kumar@bhu.ac.in	Kumar
16)	Safa Jansari	9325676431	safa.jansari@bhu.ac.in	Jansari
17)	Bhavesh R. Maske	7489951631	bhaveshmaske2022@mele.com	Bhavesh M.
18)	Sanchit Joshi	8975706788	sanchit.joshi.02@gmail.com	Joshi
19)	Aakash Dey	7972342799	aakashdey@gmail.com	Dey
20)	Tarun Gaudan	7262034396	tarungaudan@gmail.com	T.S Gaudan
21)	Vishal Gishole	9473881972	vishalgishole27@gmail.com	Gishole
22)	Pranav S. Dore	810824245	pranavdore11@gmail.com	Dore
23)	Rishi Kesh R. Dethre	8788199260	rishikeshdethre2002@gmail.com	Dethre
24)	Abhishek A. Falke	7823835535	abhishekfalke2502@gmail.com	Falke
25)	Dakshita Salunke	9088860801	dakshitasalunke2003@gmail.com	Salunke
26)	Taru S. Mohule	7057844882	tarumohule19@gmail.com	Mohule
27)	Khushi A Gupta	9922907235	kg9951930@gmail.com	Gupta

Signature of:

Seasall

Programme In-charge

Department of Computer Science
Dharampeth M. P. Deo Memorial
Science College, Nagpur

IQAC Coordinator
COORDINATOR

INTERNAL QUALITY ASSURANCE CELL
DHARAMPETH M. P. DEO MEMORIAL
SCIENCE COLLEGE, NAGPUR

Principal

Principal
Dharampeth M. P. Deo Memorial
Science College, Nagpur



DHARAMPETH M. P. DEO MEMORIAL SCIENCE COLLEGE, NAGPUR
DEPARTMENT OF COMPUTER SCIENCE
ACADEMIC SESSION: 2022-23

NOTICE

16th November 2022

All the students of B.Sc.[SEM III] are hereby informed that the Department of Computer Science, Dharampeth M.P.Deo Memorial Science College, Nagpur is going to organize one Day Workshop on Sorting and Searching Techniques in DS base on Unit III of Paper I[Data Structures] on 23th November 2022. All the students must remain present and participate in this activity.

Venue : Computer Science laboratory
Time : 1.00pm

PRINCIPAL
DHARAMPETH M.P. DEO
MEMORIAL SCIENCE COLLEGE
NAGPUR

Head, Department of Computer Science
Head,
Department of Computer Science
Dharampeth M. P. Deo Memorial
Science College, Nagpur



DHARAMPETH M. P. DEO MEMORIAL SCIENCE COLLEGE, NAGPUR
INTERNAL QUALITY ASSURANCE CELL (IQAC)
Activity Report

Date: 30th November 2022

Name of Organizing Department or Committee: Computer Science Department
Name of the activity: One Day Workshop
Suggested CRITERION point if any: Criteria II, V
Date of Activity: 23rd November 2022
Place of Activity: Computer Science Laboratory
Name of Guest Speaker/s or Judge/s or Chief Guest/s if any: Nil
Title of the Activity: Sorting and Searching Techniques in DS for the students of SEM III
[Unit III [Paper I Data Structures]
Number of Participants: 32
Name of the Teacher In-charge / Convener: Dr.Mrs.Snehal Narale
Names of other Committee Members / Staff: Nil

OUTCOME of the Activity with respect to mission vision of the institute and or academics:

The objective and purpose of this workshop was to provide training to the student's participants by presenting presenters who are experts in their fields. The workshop spurring the students participants to investigate it further on their own, or can demonstrate and encourage the practice of actual methods. At the end of the workshop students will be able:

- To enhance their learning capabilities and skills.
- It help the students to work in a group for deep discussion, gain knowledge, discuss ideas, and take part in practical activities on a particular subject.
- It help the students to work on the concept in newer way
- To enhance their hands on training skills and understand how to work on errors and the implementation of the techniques.
- It enhances their basic knowledge and get the advance subject knowledge in detail.

Activity with newspaper coverage if any: Nil

Activity data save in PC of: Dr. Mrs. Snehal Narale's Laptop



Prof. Pitambar Humane
IQAC Coordinator
IQAC Co-ordinator

Dharampeth M.P. Deo Memorial
Science College, Nagpur-440033

Dr. Mrs. Snehal Narale

Name & Signature of Teacher In-charge

Dr. Akhilesh Peshwe
Principal
Principal
Dharampeth M.P. Deo Memorial
Science College, Nagpur.



DHARAMPETH M. P. DEO MEMORIAL SCIENCE COLLEGE,
North Ambazari Road, Near Ambazari Lake, Nagpur-440033

DATA VALIDATION & VERIFICATION (DVV)

Name of the Programme : One Day workshop on Sorting & Searching Techniques in DS for BSC Sem III.
 Date of the Programme : 23/11/2022
 Name of Chief Guest if any : _____
 Name of Guest Speaker if any : _____

Sr. No.	Name of the Participant	Mobile Number	E-mail Id	Signature
1.	Nirvi A. Kuslawade	9693422005	nirvikuwadetan201@gmail.com	<i>Nirvi</i>
2.	Aditya Kumar Suryakant Singh	7350543901	aditya.singh289180@gmail.com	<i>Aditya</i>
3.	Jay Anilbhut Patil	7385496956	Jay.Patil0326@gmail.com	<i>Jay</i>
4.	Aditya Kumar S. Shukla	9518994638	adityashukla0025@gmail.com	<i>Shukla</i>
5.	Anuj H. Mishra	8103656208	anujmishra0261202@gmail.com	<i>Anuj</i>
6.	Kunal S Digraje	8010274803	kunaldigraje779@gmail.com	<i>Kunal</i>
7.	Ambujar D. Dewangan	9963624388	ambujar@gmail.com	<i>Ambujar</i>
8.	Priyesh S. Chakraborty	7498039628	priyesh.chakraborty234@gmail.com	<i>Priyesh</i>
9.	Akshay P. Khandare	7350356909	Akshay.Khandare79@gmail.com	<i>Akshay</i>
10.	Priyesh K. Kamare	7058427112	priyeshkamat77@gmail.com	<i>Priyesh</i>

Signature of:

[Signature]

Programme In-charge
Department of Computer Science
Dharampeth M. P. Deo Memorial
Science College, Nagpur

[Signature]

IQAC Coordinator
CO ORDINATOR
INTERNAL QUALITY ASSURANCE CELL
DHARAMPETH, M. P. DEO MEMORIAL
SCIENCE COLLEGE, NAGPUR

[Signature]

Principal
Dharampeth M.P. Deo Memorial
Science College, Nagpur.



DHARAMPETH M. P. DEO MEMORIAL SCIENCE COLLEGE,
North Ambazari Road, Near Ambazari Lake, Nagpur-460033

DATA VALIDATION & VERIFICATION (DVV)

11	Sakshi V. Kanade	8806934839	Sakshikanade3226@gmail.com	S.Kanade
12	Renika V. Lande	7119951401	renikalande7205@gmail.com	Renika
13	Isha S. Nemade	7029494761	ishanemade72@gmail.com	Ishane
14	Shruti B. Bedwal	890440194	Shrutibelwal1905@gmail.com	Shruti
15	Rituh K. Bisen	7028810840	rituhbisen05@gmail.com	Rituh
16	Ketan S. Bhayre	9657957276	ketanbhayre55@gmail.com	Ketan
17	Harshal Ajankar	9527732348		Harshal
18	Sumit V. Sabhe	9322410388	sumitsabhe1256@gmail.com	Sumit
19	Dudang S. Wakin	7888228500	laddudewang@gmail.com	Dudang
20	SATIL SINGH	7958868508	satilbhai06@gmail.com	Satil
21	Bhagyavati Pandey	9175902601	pandeybhagyavati@gmail.com	Bhagyavati
22	Khushboo G. Kalmik	8983760782	Khushbookalmik19@gmail.com	Khushboo
23	Khushi D. Waghade	9156520783	Khushi.waghade@gmail.com	Khushi
24	Aksharvi. Jadhav	9156916355	Aksharvi.Jadhav@gmail.com	Aksharvi
25	Vicky A. Singh	9834782931	vicky199111032001@gmail.com	Vicky
26	Sumant R. Singh	9322018536	sumantsingh123456789@gmail.com	Sumant

Signature of:

[Signature]

Program in-charge
Department of Computer Science
Dharampeth M. P. Deo Memorial
Science College, Nagpur

[Signature]

IQAC Coordinator
CO ORDINATOR
INTERNAL QUALITY ASSURANCE CELL
DHARAMPETH M. P. DEO MEMORIAL &
SCIENCE COLLEGE, NAGPUR

[Signature]

Principal
Dharampeth M. P. Deo Memorial
Science College, Nagpur.



DHARAMPETH M. P. DEO MEMORIAL SCIENCE COLLEGE,
North Ambazari Road, Near Ambazari Lake, Nagpur-440033

DATA VALIDATION & VERIFICATION (DVV)

27.	Purushottam Keshwar	7020693071	purushottamkeshwar2003@gmail.com	Prasad
28.	Sanchita Patil	7218079074	sanchitapatil2003@gmail.com	Pradip
29.	Damini Katar	8208255685	daminikatar2@gmail.com	Manvi
30.	Bhagyashree Thakre	8766925275	bhagyashreethakre2@gmail.com	Pratiksha
31.	Aditi Jate	7820812303	aditijate11@gmail.com	Alita
32.	Nutan Sujase	8805570279	nutansujase2@gmail.com	Sujase

Signature of

Pradip

Program In-charge

Department of Computer Science
Dharampeth M. P. Deo Memorial
Science College, Nagpur

Pradip

IQAC Coordinator
CO-ORDINATOR

INTERNAL QUALITY ASSURANCE CELL
DHARAMPETH, M. P. DEO MEMORIAL
SCIENCE COLLEGE, NAGPUR

Pradip

Principal

Dharampeth M. P. Deo Memorial
Science College, Nagpur.



DHARAMPETH M. P. DEO MEMORIAL SCIENCE COLLEGE, NAGPUR
DEPARTMENT OF COMPUTER SCIENCE
ACADEMIC SESSION: 2022-2023

NOTICE

14/11/2022

All the students of B.Sc. SEM [III] are hereby informed that the Department of Computer Science, Dharampeth M.P.Deo Memorial Science College, Nagpur is going to organize **Poster Making Competition** on Unit IV [Paper I] **23/11/2022**. All the students must remain present and participate in this activity.

Venue : Computer Science Laboratory

Snehal

Dr. Mrs. Snehal Narale
Head, Department of Computer Science

Head,
Department of Computer Science
Dharampeth M. P. Deo Memorial
Science College, Nagpur



DHARAMPETH M. P. DEO MEMORIAL SCIENCE COLLEGE, NAGPUR
INTERNAL QUALITY ASSURANCE CELL (IQAC)
NEP Activity Report

Date: 30th December 2022

Name of Organizing Department or Committee: Computer Science Department

Name of the activity: Poster making / Presentation Competition

Suggested CRITERION point if any: Criteria II, V

Date of Activity: 23/11/2022

Place of Activity: Computer Science laboratory

Name of Guest Speaker/s or Judge/s or Chief Guest/s If any: Nil

Title of the Activity: Poster Making / Presentation Activity on Unit IV [Paper I: Data Structures] for the students of SEM III

Number of Participants: 16

Name of the Teacher In-charge / Convener: Dr. Mrs. Snehal Narale

Names of other Committee Members / Staff: Nil

OUTCOME of the Activity with respect to mission vision of the institute and or academics:

The main objectives of this activity were to prepare the students for the competition on the topics from their syllabus and explore their ideas in the form of poster. It also helps the students:

- To allow and provide the platform to express themselves through their personal vision on the topic of their poster.
- To showcase their talent and creativity through the poster prepared by them.
- To create and enhance the team work capability.
- To able to learn and gain insight on the basic and core knowledge on the topic and to receive live feedback and encouragement from the others.

Activity with newspaper coverage if any: Nil

Activity data save in PC of: Dr. Mrs. Snehal Narale's Laptop

Prof. Pitambar Humane
IQAC Coordinator
CO ORDINATOR
INTERNAL QUALITY ASSURANCE CELL
DHARAMPETH, M. P. DEO MEMORIAL &
SCIENCE COLLEGE, NAGPUR

Dr. Mrs. Snehal Narale
Head
Name & Signature of Teacher In-charge
Department of Computer Science
Dharampeth M. P. Deo Memorial
Science College, Nagpur

Dr. Akhilesh Peshwe
Principal
Principal
Dharampeth M.P. Deo Memorial
Science College, Nagpur.



DHARAMPETH M. P. DEO MEMORIAL SCIENCE COLLEGE,
North Ambazari Road, Near Ambazari Lake, Nagpur-440033

DATA VALIDATION & VERIFICATION (DVV)

Name of the Programme : poster making presentation competition
Date of the Programme : 23/11/2023
Name of Chief Guest if any : _____
Name of Guest Speaker if any : _____

Sl. No.	Name of the Participant	Mobile Number	E-mail Id	Signature
1	Aditya Kumar Singh	7350543901	adityasingh2018@gmail.com	A.K.S.
2	Vicky Anandkikari Singh	8438342931	vicky2018@gmail.com	
3	Adityakumar S. Shukla	9518398638	adityashukla025@gmail.com	
4	Nitin A. Kushwaha	9693429805	nitinkushwaha70@gmail.com	Nitin
5	Jay A. Patil	7985436936	jay.patil022@gmail.com	Jay
6	Anuj M. Mishra	8103656208	anujmishra2512@gmail.com	Anuj
7	Ankuman D. Dorengam	9763074588	ankumanjd@gmail.com	
8	Rahul Bisen	7009810860	rahulbisen06@gmail.com	
9	Mansi Nandansax	7709322027	mansinandansax@gmail.com	
10	Vanati Chopde	9022627617	vanatichopde2002@gmail.com	

Signature of

Program In-charge
Department of Computer Science
Dharampeth M. P. Deo Memorial
Science College, Nagpur

COORDINATOR
INTERNAL QUALITY ASSURANCE CELL
DHARAMPETH, M. P. DEO MEMORIAL
SCIENCE COLLEGE, NAGPUR

Principal
Dharampeth M. P. Deo Memorial
Science College, Nagpur.



DHARAMPETH M. P. DEO MEMORIAL SCIENCE COLLEGE,
North Ambazari Road, Near Ambazari Lake, Nagpur- 440033

DATA VALIDATION & VERIFICATION (DVV)

11.	Ankur Khurpadi	7249884620	KhurpadiAnkur@gmail.com	Ankur
12.	Haitik. C. Mishra	9067445757	KumariAnugraha mishra1010@gmail.com	Haitik
13.	Pratham Sillkore	9027553288	PrathamSillkore@gmail.com	Pratham
14.	Hitesh G. Kawale	7058427112	hiteshkawale73@gmail.com	Hitesh
15.	Prithvi S. Brakkar	7498039428	PrithviBrakkar@gmail.com	Prithvi
16.	Atharva P. Umate	9294691211	AtharvaUmate@gmail.com	Atharva

Signature of:

Program In-charge
Department of
Dharampeth M. P. Deo Memorial
Science College, Nagpur

CO-ORDINATOR
INTERNAL QUALITY ASSURANCE CELL
DHARAMPETH, M. P. DEO MEMORIAL &
SCIENCE COLLEGE, NAGPUR

Principal
Dharampeth M.P. Deo Memorial
Science College, Nagpur.



DHARAMPETH M. P. DEO MEMORIAL SCIENCE COLLEGE, NAGPUR
INTERNAL QUALITY ASSURANCE CELL (IQAC)

Activity Report

Date: 30/11/2022

Name of Organizing Department or Committee: Computer Science

Name of the activity: Resolving the queries on the basis of given data

Suggested CRITERION point if any: V

Date of Activity: 23/11/2022

Place of Activity: Room Number 03 (College Premises)

Name of Guest Speaker/s or Judge/s or Chief Guest/s if any: NA

Title of the Activity: Relational Algebra Fundamental and Extended Operations

Number of Participants: 38

Name of the Teacher In-charge / Convener: Mrs. Ruma Kapre

Names of other Committee Members / Staff: NA

OUTCOME of the Activity with respect to mission vision of the institute and or academics:

Through the activity students learned how to write the queries of relational algebra on the basis of data provided to them. They studied all the syntax and rules to write the queries on the data.

Activity with newspaper coverage if any: NA

Activity data save in PC of: Mrs. Ruma Kapre



Mrs. Ruma Kapre

Name & Signature of Teacher In-charge

Prof. Pitambar Humane
IQAC Coordinator

CO ORDINATOR
INTERNAL QUALITY ASSURANCE CELL
DHARAMPETH, M. P. DEO MEMORIAL &
SCIENCE COLLEGE, NAGPUR

Dr. Akhilesh Peshwe
Principal

Principal
Dharampeth M.P. Deo Memorial
Science College, Nagpur



DHARAMPETH M. P. DEO MEMORIAL SCIENCE COLLEGE,
North Ambazari Road, Near Ambazari Lake, Nagpur- 440033

DATA VALIDATION & VERIFICATION (DVV)

Name of the Programme

: Resolving the queries on basis of given data [SEM V: Unit III]

Date of the Programme

: 23/11/2022

Name of Chief Guest if any

:

Name of Guest Speaker if any

:

Sr. No.	Name of the Participant	Mobile Number	E-mail Id	Signature
1.	Branjal D. Sawadkar	7385458520	branjal50141234@gmail.com	
2.	Diya R. Patil	7757052463	diyapatil553@gmail.com	
3.	Ruchita S. Bhayra	9527832686	ruchitabhayra407@gmail.com	
4.	Sanchit Joshi	8975706788	sanchit.joshi03@gmail.com	
5.	Tanmay S. Gadam	7262034386	tanmaygadaml@gmail.com	T.S. Gadam
6.	Rishikesh R. Dethle	8788199260	rishikeshdethle2002@gmail.com	
7.	Vishal V. Girhale	9673626472	vishalgirhale92@gmail.com	
8.	Saunabh V. Raut	9527283213	saunabh.raut@gmail.com	
9.	Akash Das	7972942709	akashdas@gmail.com	
10.	Abdul Raafiq Aman	7666938578	raufkaman2811@gmail.com	

Signature of:

Programme In-charge

Mrs. Ruma Kapore

IQAC Coordinator
CO ORDINATOR

INTERNAL QUALITY ASSURANCE CELL
DHARAMPETH, M. P. DEO MEMORIAL &
SCIENCE COLLEGE, NAGPUR

Principal
Principal

Dharampeth M.P. Deo Memorial
Science College, Nagpur.



DHARAMPETH M. P. DEO MEMORIAL SCIENCE COLLEGE,
North Ambazari Road, Near Ambazari Lake, Nagpur- 440033

DATA VALIDATION & VERIFICATION (DVV)

11	Khushi Dave	9890009937	kd8587477@gmail.com	Khushi
12	Praraj S. Dore	8830624245	prarajdore97@gmail.com	Praraj
13	Sumet S. Bhalchkar	9021627757	sumi.s.bhalchkar262@gmail.com	S.Bhalchkar
14	Bhavesh R. Maske	7989951631	bhaveshmaske2902@gmail.com	Bhavesh M.
15	Bhavesh D. Mathur	9021317056	bhaveshmathur7181700@gmail.com	Bmath
16	Soni A. Rai	8855989508	Soniarunai17@gmail.com	Soni
17	Sakshi Huddar	9405142450	makulhuddar@gmail.com	Sakshi Huddar
18	Sahil R. Jitode	9373414643	Sahiljitode7@gmail.com	Sahil
19	Tatyang Panke	8767339548	brongpanke2002@gmail.com	Tatyang
20	Neha J. Bankar	8055477553	neha2002bankar@gmail.com	Neha
21	Komal M Kumbhure	7620314869	kumbhurekomal04@gmail.com	Komal
22	Tanuj S. Mohule	7057844882	tanujmohule45@gmail.com	Tanuj
23	Samiksha Tabhare	9307133963	samikshavtabhare@gmail.com	Samiksha
24	Samiksha R. Khatore	9604473539	rekhatkhatore@gmail.com	Samiksha
25	Sujata. P. Sonwane	9021135140	sujatasonwane2001@gmail.com	Sujata
26	Dikshita Sathare	9028830801	dikshitasathare@gmail.com	Dikshita

Signature of:

Programme In-charge

IQAC Coordinator
CO ORDINATOR

INTERNAL QUALITY ASSURANCE CELL

Principal

Dharampeth M.P. Deo Memorial
Science College, Nagpur.



DHARAMPETH M. P. DEO MEMORIAL SCIENCE COLLEGE,
North Ambazari Road, Near Ambazari Lake, Nagpur- 440033

DATA VALIDATION & VERIFICATION (DVV)

26)	Seema wadan lakdar	7058728070	Seemalakda073@gmail.com	
27)	Riddhi Abhay Rajpuro	9669774021	riddhinasikar2@gmail.com	
28)	Aarti B. Singh	7709208740	AartiBSing@gmail.com	
29)	Pratiksha S. Chaudhari	7507317699	chudharypratiksha2000@gmail.com	
30)	Khusli A. Gupta	9922997235	kg098920@gmail.com	
31)	Nikhil Jankar	8530966607	nikhilyc-kar@gmail.com	
32)	Pratham Sonar	901144990	SonarPratham439@gmail.com	
33)	Rajat Rohad	9175635273	RajRohad@gmail.com	
34)	Pranay Mahajan	7385551492	Pranaymahajan413@gmail.com	
35)	Mahesh Maske	9021951173	maheshmaske49@gmail.com	
36)	Mukund S. Hood	9604785622	MukundHood@gmail.com	
37)	Abhishek A. Falke	7823835535	abhishekfalke88@gmail.com	
38)	Ritu Choudhary			

Signature of:

Programme In-charge

IQAC Coordinator

INTERNAL QUALITY ASSURANCE CELL
DHARAMPETH, M. P. DEO MEMORIAL &
SCIENCE COLLEGE, NAGPUR

Principal

Dharampeth M.P. Deo Memorial
Science College, Nagpur.



DHARAMPETH M. P. DEO MEMORIAL SCIENCE COLLEGE, NAGPUR

INTERNAL QUALITY ASSURANCE CELL (IQAC)

Activity Report

Date: 23rd November 2022

Name of Organizing Department or Committee: Electronics Department

Name of the Activity : Seminar(NEP)

Suggested CRITERION point if any: Suggested criteria II

Date of Activity: 23rd November 2022

Place of Activity : Electronics Lab

Name of Guest Speaker/s or Judge/s or Chief Guest/s if any : Not applicable

Title of the Activity: Seminar

Based on Unit : 4(Paper I & II)

Class : Semester I

Number of Participants: 17

Name of the Teacher In-charge / Convener: Mrs. Leena P. Thakare

OUTCOME of the Activity with respect to mission vision of the institute and or academics:

Different topics were taken by the students from the syllabus and presentation was given in the Electronics Lab. All the topics were taken from the syllabus. Questions were asked after the presentation.

Prof. Vinita V. Rangari

Head of the Department

Prof. Pitambar Humane

IQAC Coordinator

CO ORDINATOR

**INTERNAL QUALITY ASSURANCE CELL
DHARAMPETH, M. P. DEO MEMORIAL &
SCIENCE COLLEGE, NAGPUR**

Dr. Akhilesh Peshwe

Principal

**Dharampeth M.P. Deo Memorial
Science College, Nagpur.**



Dharampeth M. P. Deo Memorial Science College,
Nagpur

Electronics Department
Semester I - (2022-23)

Seminar

Date : 23/11/2022

Sr. No	Name of Student	Topic	Signature	Date
1.	TUSHAL ACHARE	Multiplexer		23/11/22
2.	KHUSHBU PALI	T Flip Flop		
3.	KHUSHI PALI	JK Flip Flop		
4.	SANDEEP KUMAR	Universal gates		23/11/2022
5.	ABHISHEK SINGH	Encoder & Decoder		23/11/2022
6.	VINEET SINGH			
7.	VARSH GURUPANCH			
8.	VEDANT UMRETKAR	De-multiplexer		23/11/22
9.	UDAY BAGHELE	1's complement		23/11/2022
10.	ANUGRAH ADKANE			
11.	TEJAS CHELMELWAR			23/11/2022
12.	TEJAS DONGRE	2's complement		23/11/22
13.	ISHA WAGHMARE	Preset and clear operation		23/11/22
14.	VED CHOUDHARY	LVDI		23/11/2022
15.	PRIYANSHU SINGH			
16.	ANIKET BAWANKAR			23/11/2022
17.	TANU SINGH	Adder and Subtractor		23/11/22
18.	AAYUSHI SINGH	D Flip Flop		
19.	MONALI SHENDE			
20.	VAIDHVEE GONGAL	De-Morgan's theorem		23/11/22
21.	YOGESH YADAV			
22.	PRANAY CHOUDHARY			



DHARAMPETH M. P. DEO MEMORIAL SCIENCE COLLEGE, NAGPUR

Department of Electronics

Semester I- (2022-23)

Seminar

Sr. No.	Student Name	Mobile Number	Email ID
1	Tushal Rupkumar Achare	9075995617	acharetushal5@gmail.com
2	Sandeep Rakesh Kumar Kumar	8081144948	sandeepk27900@gmail.com
3	Abhishek Ravindra Singh	8208948107	abhi0882005@gmail.com
4	Vedant Onkar Umretkar	9049932753	umretkarvedant@gmail.com
5	Uday Chandrashekhar Baghele	8459549609	bagheleuday@gmail.com
6	Tejas Rajesh Cheimelwar	9604662119	tejaschelmelwar@gmail.com
7	Tejas Ramesh Dongre	9322578918	tejasdongre453@gmail.com
8	Isha Ishwar Waghmare	8855919474	ishawaghmare9474@gmail.com
9	Ved Sudhir Choudhary	7498572766	vedchoudhary.cs.749@gmail.com
10	Aniket Jayram Bawankar	9322804484	adityabawankar9@gmail.com
11	Tanu Ajay Singh	8806355808	tanusingh63492@gmail.com
12	Vaidhavi Baburao Gongal	7507907278	gayatrigongal787@gmail.com
13	Simran Narendra Dhimole	8390347026	mishralaxmi210@gmail.com
14	Kashish Kamalkumar Bisen	7887886117	kashishbisen05@gmail.com
15	Deepak Surendra Kumar Kumar	7061735473	gauravasharma2@gmail.com
16	Tannu Arun Varthi	9322044903	tannuvarthi@gmail.com
17	Yogita Jaysing Karemore	8381045307	swara.karemore25@gmail.com

Name & Signature of Teacher In-Charge

Prof. Pitambar Humane
IQAC Coordinator

CO ORDINATOR
INTERNAL QUALITY ASSURANCE CELL
DHARAMPETH, M. P. DEO MEMORIAL &
SCIENCE COLLEGE, NAGPUR

Name & Signature of Head of the
Department

Dr. Varsha V. Ran...
Professor & Head
Department of Elect...
Dharampeth M.P. Deo M...
Science College, Nagpur...

Dr: Akhilesh Peshwe
Principal
Principal

Dharampeth M.P. Deo Memorial
Science College, Nagpur.



DHARAMPETH M. P. DEO MEMORIAL SCIENCE COLLEGE, NAGPUR
INTERNAL QUALITY ASSURANCE CELL (IQAC)

Activity Report

Date: 30/11/2022

Name of Organizing Department or Committee: Computer Science

Name of the activity: B.SC 1st Year Seminar

Suggested CRITERION point if any: Nil

Date of Activity: 23/11/2022

Place of Activity: Room No. 4

Name of Guest Speaker/s or Judge/s or Chief Guest/s if any: Nil

Title of the Activity: Seminar

Number of Participants: 52

Name of the Teacher In-charge / Convener: _Mrs.Shraddha A.Ozarkar

Names of other Committee Members / Staff: Nil

OUTCOME of the Activity with respect to mission vision of the institute and or academics:

The seminar was very useful to students. It improved their knowledge and good understanding of the topic as some topics are related to syllabus. It will be useful to them in future.

Activity with newspaper coverage if any: No

Activity data save in PC of: Yes

Note: Kindly share geotag photographs separately along with report on iqacdsc2022@gmail.com



Prof. Pitambar Humane
IQAC Coordinator

CO ORDINATOR
INTERNAL QUALITY ASSURANCE CELL
DHARAMPETH, M. P. DEO MEMORIAL &
SCIENCE COLLEGE, NAGPUR

Mrs. Shradha A. Ozarkar
Name & Signature of Teacher In-cha

Dr. Akhilesh Peshwe
Principal

Principal
Dharampeth M.P. Deo Memorial
Science College, Nagpur.



DHARAMPETH M. P. DEO MEMORIAL SCIENCE COLLEGE,
North Ambazari Road, Near Ambazari Lake, Nagpur - 440033

DATA VALIDATION & VERIFICATION (DVV)

Name of the Programme : B.Sc - I Seminar (29/11/22)
 Date of the Programme : Activity
 Name of Chief Guest if any : _____
 Name of Guest Speaker if any : _____

Sr. No.	Name of the Participant	Mobile Number	E-mail Id	Signature
1]	Varsha L. Tukkar	9973650950	varshatukkar482@gmail.com	<i>Varsha</i>
2]	Janhvi H. Laibey	8446510539	Janhvihb-189@gmail.com	<i>Janhvi</i>
3]	Aakshi A. Mishra	9529888315	amishra39683@gmail.com	<i>Aakshi</i>
4]	Veena U. Borikar	9322016921	veena.borikar14@gmail.com	<i>Veena</i>
5]	Janhvi. M. Joge	7385060171	Janhvi Joge 07@gmail.com	<i>Janhvi</i>
6]	Rutika G. Yadav	9446085945	yadavarutika34@gmail.com	<i>Rutika</i>
7]	Shilpa Shetye	9130091500	shilpashetye31@gmail.com	<i>Shilpa</i>
8]	Simran Bhimale	7665330683	simranbhimale30@gmail.com	<i>Simran</i>
9]	TANU. H. SINGH	8806355808	tanusingh6949@gmail.com	<i>Tanu</i>
10]	Jagruhi : Palkar	8767910709	Jagruhi.palkar@gmail.com	<i>Jagruhi</i>
	Tushar Achare	9075955617	achare.tushar5@gmail.com	<i>Tushar</i>

Signature of: *Tushar Achare*
 Programme In-charge Head,

[Signature]
 IQAC Coordinator
 CO ORDINATOR
 INTERNAL QUALITY ASSURANCE CELL
 DHARAMPETH M. P. DEO MEMORIAL
 SCIENCE COLLEGE, NAGPUR

[Signature]
 Principal
 Dharampeth M. P. Deo Memorial
 Science College, Nagpur.

Department of Computer Science
 Dharampeth M. P. Deo Memorial
 Science College, Nagpur.



DHARAMPETH M. P. DEO MEMORIAL SCIENCE COLLEGE,
North Ambazari Road, Near Ambazari Lake, Nagpur- 440033

DATA VALIDATION & VERIFICATION (DVV)

12.	Kashish K. Bisen	7857886117	kashishbisen@gmail.com	Kashish
13.	Tena Waghmare	885919474	tshauinghmare247@gmail.com	Tena
14.	Chena S. Buike	8010342968	chenuchena@gmail.com	Chena
15.	Devashri Khande	9091341265	katedevashri@gmail.com	D. P. Khande
16.	Amita Niwa	7058425021	amitaniwa70@gmail.com	Amita
17.	Nisha Kosarkar	34690996645	nishakosarkar@gmail.com	Nisha
18.	Vaidhavi Gyongal	7507407278		
19.	Vidya Lathi	7020963219	vidyalathi@gmail.com	Vidya
20.	Manali Shende	7736516257	shendemanali@gmail.com	Manali
21.	Utkarsha Torale	7499159178	utkarshatorale@gmail.com	Utkarsha
22.	Jashvi Kirsaykar	7055235243	kirshajashvi@gmail.com	Jashvi
23.	Prudhaya B. Tapude	8010362832	prudhaya.tapude@gmail.com	Prudhaya
24.	Pranali Chitambar	8767581278	pranali.chitambar@gmail.com	Pranali
25.	Vaideli Nagarkar	9325963046	vaideli.nagarkar@gmail.com	Vaideli
26.	Tanuja Yelure	9529447565	Tanujayelure@gmail.com	Tanuja
27.	Divyani Zade	7972403069	divyanizade2005@gmail.com	Divyani

Signature of:

Programme In-charge

Head,
Department of Computer Science
Dharampeth M. P. Deo Memorial
Science College, Nagpur

IGAC Coordinator

CO ORDINATOR
INTERNAL QUALITY ASSURANCE CELL
DHARAMPETH M. P. DEO MEMORIAL &
SCIENCE COLLEGE, NAGPUR

Principal

Principal
Dharampeth M.P. Deo Memorial
Science College, Nagpur.



DHARAMPETH M. P. DEO MEMORIAL SCIENCE COLLEGE,
North Ambazari Road, Near Ambazari Lake, Nagpur-440013

DATA VALIDATION & VERIFICATION (DVV)

27	Sandeep Kumar	9021144914	Sandeepkumar27@gmail.com	27/11/2023
28	Tegus Dongre	9522578918	tegusdongre@gmail.com	28/11/2023
30	Mahesh D. Chavhan	9055328351	maheshdchavhan@gmail.com	30/11/2023
31	Vedant S. Chaudhary	7698971706	vedantchaudhary@gmail.com	31/11/2023
32	Prayanshu Singh	952331028	prayanshusingh@gmail.com	32/11/2023
33	Anurag Kulkarni	9028897552	anuragkulkarni@gmail.com	33/11/2023
34	Mahesh D. Pawate	9112345119	maheshd.pawate@gmail.com	34/11/2023
35	Vedant O. Umethkar	9049972953	vedantu.umethkar@gmail.com	35/11/2023
36	Gendral B. Machade	911842728	gendralmachade@gmail.com	36/11/2023
37	Aniket Sawant	976727301	aniket.sawant@gmail.com	37/11/2023
38	Pratik D. Chavhan	9021640532	pratikdchavhan@gmail.com	38/11/2023
39	Vibhanshu Tejne	9561232204	vibhanshutejne@gmail.com	39/11/2023
40	Rishabh Kulkarni	7438066424	rishabhkulkarni@gmail.com	40/11/2023
41	Badal B. Samkumar	7448247750	badalsamkumar@gmail.com	41/11/2023

Signature of:

[Signature]
Programme in-charge

Head,

Department of Computer Science
Dharampeth M. P. Deo Memorial
Science College, Nagpur

[Signature]

IQAC Coordinator

CO ORDINATOR

INTERNAL QUALITY ASSURANCE CELL
DHARAMPETH, M. P. DEO MEMORIAL
SCIENCE COLLEGE, NAGPUR

[Signature]

Principal

Principal

Dharampeth M.P. Deo Memorial
Science College, Nagpur



DHARAMPETH M. P. DEO MEMORIAL SCIENCE COLLEGE,
North Ambazari Road, Near Ambazari Lake, Nagpur-440033

DATA VALIDATION & VERIFICATION (D.V.V)

41a	Muskan S. Vaidya	9509775557	Muskan Vaidya - 2017 - M. Sc. (IT)
42	Baniksha Y. Bawe	9579736710	Baniksha Bawe - 2017 - M. Sc. (IT)
43	Simi Kshya. A. Parichhidha	9203005700	Simi Kshya Parichhidha - 2017 - M. Sc. (IT)
44	Jasni. V. Khade	7355066530	Jasni Khade - 2017 - M. Sc. (IT)
45	Diyani Zogale	91280019	Diyani Zogale - 2017 - M. Sc. (IT)
46	Purnali Gupta	6020069377	Purnali Gupta - 2017 - M. Sc. (IT)
47	Aditi Jagi	75799162108	Aditi Jagi - 2017 - M. Sc. (IT)
48	Rohini Pandey	97755503	Rohini Pandey - 2017 - M. Sc. (IT)
50	Mona Pal	73500150170	Mona Pal - 2017 - M. Sc. (IT)
51c	Rashmi Pardihi	7003137412	Rashmi Pardihi - 2017 - M. Sc. (IT)
52	Pratik Kishore	8122765245	Pratik Kishore - 2017 - M. Sc. (IT)

Signature of:

[Signature]
Programme In-charge

Head,

Department of Computer Science
Dharampeth M. P. Deo Memorial
Science College, Nagpur

[Signature]

IQAC Coordinator

COORDINATOR

INTERNAL QUALITY ASSURANCE CELL
DHARAMPETH M. P. DEO MEMORIAL &
SCIENCE COLLEGE, NAGPUR

[Signature]
Principal

Principal

Dharampeth M. P. Deo Memorial
Science College, Nagpur



DHARAMPETH M. P. DEO MEMORIAL SCIENCE COLLEGE, NAGPUR
INTERNAL QUALITY ASSURANCE CELL (IQAC)

NEP Activity Report

Date: 23/11/22

Name of Organizing Department or Committee: Chemistry Department

Name of the activity: NEP Activity Report (Sem- I, Unit-IV)

Suggested CRITERION point if any: Criteria II

Date of Activity: 23/11/22

Place of Activity: Chemistry Department Laboratory

Name of Guest Speaker/s or Judge/s or Chief Guest/s if any: Nil

Title of the Activity: Identification of food adulteration in daily life and Types

Number of Participants: 31

Name of the Teacher In-charge / Convener: Dr. Pranita Gawande, Niharika Sute

Names of other Committee Members / Staff: Dr. Vaishali Meshram

OUTCOME of the Activity with respect to mission vision of the institute and or academics:

This is student centric activity. The aim of this activity is to check contamination in food product like Tea leaves, Coffee, Turmeric powder, Chilli powder and Milk as adulterated food is highly toxic and leads to several health issues.



Activity with newspaper coverage if any: Nil

Activity data save in PC of: Chemistry Department

Note: Kindly share geotag photographs separately along with report on iqacdsc2022@gmail.com

Prof. Pitambar Humane
IQAC Coordinator

CO ORDINATOR
INTERNAL QUALITY ASSURANCE CELL
DHARAMPETH, M. P. DEO MEMORIAL &
SCIENCE COLLEGE, NAGPUR

Name & Signature of Teacher In-charge

Dr. Pranita Gawande

Dr. Akhilesh Peshwe
Principal

PRINCIPAL
Dharampeth M.P. Deo Memorial
Science College, Nagpur-440033



DHARAMPETH M. P. DEO MEMORIAL SCIENCE COLLEGE,
North Ambazari Road, Near Ambazari Lake, Nagpur-440033

DATA VALIDATION & VERIFICATION (DVV)

NEP Activity-4 on unit-IV (Sem-I)

Name of the Programme : Identification of Food adulteration in daily life & Types
Date of the Programme : 23/11/22
Name of Chief Guest if any :
Name of Guest Speaker if any :

Sr. No.	Name of the Participant	Mobile Number	E-mail Id	Signature
1.	Pawan Thakre	9262969113	thakre Pawan 739@gmail.com	
2.	Arjun sharma	7620107398	arjun 7010 sharma@gmail.com	
3.	Ritika Bhojar	9834587087	ritika bhojar 22@gmail.com	
4.	Manika Patel	7499225462	manika patel 103@gmail.com	
5.	Ankit Patel	9976905638	ankit patel 797275@gmail.com	
6.	Durgesh Ghodmare	9075318618	durgeshghodmare@gmail.com	
7.	Kaashona Pasad	9309318662		
8.	Shreya Sha	8983236002	Sangeetash 030@gmail.com	
9.	Arjun sharma	7020107398	arjun 7010 sharma@gmail.com	
10.	Aakansha mairal	8010923662	aakgogji 2004@gmail.com	
11.	Ruchi elwivedi	8080776893	Ruchielwivedi23@gmail.com	
12.	Shivam Patel	7038889083	SP040263@gmail.com	
13.	saurabh chaudhary	9359893501	schaudhary 5599@gmail.com	
14.	pratikha Bhusari	7821048413	pbhusari 718@gmail.com	

Signature of:
Programme In-charge

IQAC Coordinator
CO ORDINATOR
INTERNAL QUALITY ASSURANCE CELL
DHARAMPETH, M. P. DEO MEMORIAL &
SCIENCE COLLEGE, NAGPUR

Principal
PRINCIPAL
Dharampeth M.P. Deo Memorial
Science College, Nagpur-440033



DHARAMPETH M. P. DEO MEMORIAL SCIENCE COLLEGE,
North Ambazari Road, Near Ambazari Lake, Nagpur- 440033

DATA VALIDATION & VERIFICATION (DVV)

15	Sharyan A jha.	8983236002	sangeeta_jha030@gmail.com	sharyan jha
16	Aajun sharma	2020107398	aajun7010sharma@gmail.com	A. Sharma
17	Ray. N Mehsharam	9529927031	rymeshem14@gmail.com	Ray. Mehsharam
18	Aniket. kumse	8262817299	avetkumse@gmail.com	ANIKET
19	Shyam Patel	7038889083	SP040263@gmail.com	Shyam Patel
20	Ashwini Narote	8295566422	AshwiniNarote123@gmail.com	Ashwini Narote
21	Aparna Mahare	7020649887	AparnaMahare123@gmail.com	A. Mahare
22	Sejal. D Kolhe	8483045985	kolheSejal04@gmail.com	Sejal Kolhe
23	Monika I patel	7499225468	monikapatel1438@gmail.com	M. Patel
24	parvina B Bhosari	9821048413	parvinaBhosari@gmail.com	P. Bhosari
25	Ritika. R Bhoyar	9894587087	RitikaBhojar28@gmail.com	R. Bhoyar
26	skiteel. O. Patil.	9764596337	SP@gmail.com	S. Patil
27	poiya R. Dulbey	8669495362	dulbeyrameshpatil@gmail.com	P. Dulbey
28	Apeksha. Digambarhota	7559455994	apekshakarokhota@gmail.com	A. Digambarhota
29	maleshwari mahendrabhai	9022137975	maleshwaribhokrao@gmail.com	Maheshwari
30	yogita Ramesh Dege	7058437240	yogitadenge@gmail.com	Yogita Ramesh

Signature of:

Programme In-charge

IQAC Coordinator

CO-ORDINATOR
INTERNAL QUALITY ASSURANCE CELL
DHARAMPETH M. P. DEO MEMORIAL S.
SCIENCE COLLEGE, NAGPUR

Principal

PRINCIPAL
Dharampeth M. P. Deo Memorial
Science College, Nagpur-440033



DHARAMPETH M. P. DEO MEMORIAL SCIENCE COLLEGE, NAGPUR
INTERNAL QUALITY ASSURANCE CELL (IQAC)
NEP Activity Report

Date: 30 /11/2022

Name of Organizing Department or Committee: Chemistry

Name of the activity: NEP Activity (SEM III –PAPER-2-UNIT-4)

Suggested CRITERION point if any: CRITERION -II

Date of Activity- 23 /11/ 2022

Place of Activity: - Chemistry Department

Name of Guest Speaker/s or Judge/s or Chief Guest/s if any: NIL

Title of the Activity: Carboxylic acid in plants as natural sources

Number of Participants: 44

Name of the Teacher In-charge / Convener: Dr Tanishq Chaudhari

Names of other Committee Members / Staff- Dr V.P. Meshram

OUTCOME of the Activity with respect to mission vision of the institute and or academics:

Students aware about the importance of carboxylic acid in day to day life and their sources

Activity with newspaper coverage if any: Nil

Activity data save in PC of: Department of Chemistry

Note: Kindly share geotag photographs separately along with report on igacdsc2022@gmail.com

Other Important Organic Acids

Organic acid	Where it is found
Lactic acid	Sour milk
Oxalic acid	Rhubarb plant
Citric acid	Limes, lemons
Formic acid	Insect bites
Tartaric acid	Grape juice
Acetic acid	Vinegar
Malic acid	Apples and pears



Prof. Pitambar Humane
COORDINATOR
INTERNAL QUALITY ASSURANCE CELL
DHARAMPETH, M. P. DEO MEMORIAL &
SCIENCE COLLEGE, NAGPUR

Tanishq
Name & Signature of Teacher In-charge
(Dr. T. Chaudhari).

Dr. Akhilesh Peshwe
Principal
PRINCIPAL

Dharampeth M.P. Deo Memorial
Science College, Nagpur-440033



(2022-2023)
Bsc. Sem-3.
DHARAMPETH M. P. DEO MEMORIAL SCIENCE COLLEGE,
North Ambazari Road, Near Ambazari Lake, Nagpur-440033

23/11/2022

DATA VALIDATION & VERIFICATION (DVV)

Name of the Programme : NEP ACTIVITY (SEM III ; PAPER-2 ; UNIT-4)
Date of the Programme : 23 / 11 / 2022 .
Name of Chief Guest if any : _____
Name of Guest Speaker if any : _____

Sr. No.	Name of the Participant	Mobile Number	E-mail Id	Signature
1	Jasraj Dekhal Paliwal	9370820325	jasrajpaliwal47@gmail.com	
2	Shashank Chandra Pandey	9998644684	Pandeyshashank352@gmail.com	
3	Aniket Vinod Kulkade	7709629106	aniketkulkade61@gmail.com	
4	Samirra Ghoshal			
4	Kajal P. Nighot	9573250623	kajurnighot2008@gmail.com	
5	Bhumika V. Thakre	7218247917	Bhumikathakre55@gmail.com	
6	Dharmapuri Lal	9975037356	dharmapurilalraj@gmail.com	
7	Rushali D. Bhoskar	9579485597	rushalibhoskar@gmail.com	
8	Sejal R. Lakhonpal	9028851568	sejalalakhonpal@gmail.com	
9	Tejaswini K. Thakare	9356009926	thakaretejaswini@gmail.com	

Signature of:

Programme In-charge

IQAC Coordinator

CO ORDINATOR

INTERNAL QUALITY ASSURANCE CELL
DHARAMPETH, M. P. DEO MEMORIAL &
SCIENCE COLLEGE, NAGPUR

Principal
Principal

Dharampeth M.P. Deo Memorial
Science College, Nagpur.



DHARAMPETH M. P. DEO MEMORIAL SCIENCE COLLEGE,
North Ambazari Road, Near Ambazari Lake, Nagpur- 440033

DATA VALIDATION & VERIFICATION (DVV)

20	Mansi Ashok Badale	7796308467	mansibadale@gmail.com	<u>Badale</u>
21	Mansi Sharm Fating	8767154686	mansifating2110@gmail.com	<u>Fating</u>
22	Shreyash .B. Chatte	8446354089	chatteshreyash250@gmail.com	<u>Chatte</u>
23	Kautili Mishra	9657199261		<u>Mishra</u>
24)	Jyoti . J. Sharmu	8669736380	jyotis8390@gmail.com	<u>J. Sharmu</u>
25)	Sania Midhat Raje	8975726700		<u>Raje</u>
26)	Nipun Sharma	9392042259		<u>Sharma</u>
27)	Amushree Chandel	9145631751		<u>Chandel</u>
28)	Smriti vaidya	8856908764		<u>Vaidya</u>
29)	Aisina Sheikh	8080083981		<u>Sheikh</u>
30	Aravi Raut	9767873447		<u>Raut</u>
31	Vaishravi Saradan Bedade	8657188093		<u>Bedade</u>
32	Daashara S. Madawp	8830146516		<u>Madawp</u>
33	Ketaki R. KisPal	9112759060		<u>KisPal</u>
34	Rutik V. Gajbhiye	7620826960		<u>Gajbhiye</u>

Signature of:

Tamshe

Programme In-charge

[Signature]

CO-ORDINATOR
INTERNAL QUALITY ASSURANCE CELL
DHARAMPETH, M. P. DEO MEMORIAL
SCIENCE COLLEGE, NAGPUR

[Signature]

Principal
Dharampeth M. P. Deo Memorial
Science College, Nagpur.



DHARAMPETH M. P. DEO MEMORIAL SCIENCE COLLEGE,
North Ambazari Road, Near Ambazari Lake, Nagpur- 440033

DATA VALIDATION & VERIFICATION (DVV)

35	Mansi Mate	8467891807		
36	Jagauti D. Warkar	7447366023		
37	Zakshi Meshram	9145355733		
38	Juhi Chaudhari	8660248944		
39	Surabhi Pawde	7887516628		
40	Kitika M. Vaid	9356744234		
41	Devashri D. Bisen	8698119070		
42	Devashish Bisen	7167961231		
43	Pratik D. Lilhare	9307480168		
44	Chetna D. Bhopre	9021058104		
45	Riya R. Kulmethe	7420956528		
46	Shreyas S. Bagde	8669883639		

Signature of:

Programme In-charge

IQAC Coordinator
COORDINATOR
INTERNAL QUALITY ASSURANCE CELL
DHARAMPETH, M. P. DEO MEMORIAL
SCIENCE COLLEGE, NAGPUR

Principal
Principal
Dharampeth M.P. Deo Memorial
Science College, Nagpur.



DHARAMPETH M. P. DEO MEMORIAL SCIENCE COLLEGE, NAGPUR
INTERNAL QUALITY ASSURANCE CELL (IQAC)

Activity Report

Date: 23rd Nov. 2022

Name of Organizing Department or Committee: Home Science

Name of the activity: Preparation of Charts

Suggested CRITERION point if any:

Date of Activity: 23rd Nov. 2022

Place of Activity: Home Science Department

Name of Guest Speaker/s or Judge/s or Chief Guest/s if any: NA

Title of the Activity:

Creating Social Awareness among society

Number of Participants: 12

Name of the Teacher In-charge/Convener: Dr. Ashwini Meshram

Name of other Committee Members/Staff: Mrs. Rekha and Mrs. Vaishali

OUTCOME of the Activity with respect to mission vision of the institute and or academics:

Students learn different societal problems, environmental balance, media impact on society etc.

Activity with newspaper coverage if any: NA

Activity data save in PC of:

Prof. Pitambar Humane
IQAC Coordinator

CO ORDINATOR
INTERNAL QUALITY ASSURANCE CELL
DHARAMPETH, M. P. DEO MEMORIAL &
SCIENCE COLLEGE, NAGPUR

(Dr. Ashwini Meshram)
Name & Signature of Teacher In-charge

Dr. Akhilesh Peshwe
Principal

Dharampeth M. P. Deo Memorial
Science College, Nagpur.



DHARAMPETH M. P. DEO MEMORIAL SCIENCE COLLEGE,
North Ambazari Road, Near Ambazari Lake, Nagpur- 440033

DATA VALIDATION & VERIFICATION (DVV)

Name of the Programme : Preparation of charts - Creating social awareness among the Society
Date of the Programme : 23rd Nov. 2022
Name of Chief Guest if any : -
Name of Guest Speaker if any : -

Sr. No.	Name of the Participant	Mobile Number	E-mail Id	Signature
1.	Prerna J. Chaudhari	7620384149	choudhaniprerna294@gmail.com	P. Chaudhari
2.	shalu I. Porekhi	8829115380	shaluporekhi5@gmail.com	Shaluk
3.	Minal I. Patte	9158070732	patteminaka@gmail.com	Minal
4.	Aditi R. Vaidya	9075714591	aditivaidya813@gmail.com	Aditi
5.	Anshikha U. Jaisankar	9021391207	anshikhajaisankar@gmail.com	Anshikha
6.	Hemlata Varna	7744958026	vvarmahemlata957@gmail.com	Hemlata
7.	shubhangi Nishad	9923455073	shubhanishad2510@gmail.com	Shubhangi
8.	SAKSHI R. CHAKUNDE	7843018801	sakshichakunde@gmail.com	Sakshir
9.	Bhanu Gurusarani	9888437303	bhanugurusarani@gmail.com	Bhanu
10.	Aanchal Kokande	9309660449	aanchal.kokande@gmail.com	Aanchal

Signature of:

Programme In-charge

CO ORDINATOR
INTERNAL QUALITY ASSURANCE CELL
DHARAMPETH, M. P. DEO MEMORIAL &
SCIENCE COLLEGE, NAGPUR

Principal
Dharampeth M. P. Deo Memorial
Science College, Nagpur.



DHARAMPETH M. P. DEO MEMORIAL SCIENCE COLLEGE,
North Ambazari Road, Near Ambazari Lake, Nagpur- 440033

DATA VALIDATION & VERIFICATION (DVV)

11.	Neha Vishwakarma	89835 34173	Neha.vishwakarma@gmail.com	
12.	Ashwini Pandey	8308621072	Ashwini.pandey@gmail.com	

Signature of:

Programme In-charge

COORDINATOR
INTERNAL QUALITY ASSURANCE CELL
DHARAMPETH, M. P. DEO MEMORIAL &
SCIENCE COLLEGE, NAGPUR.

Principal
PRINCIPAL
Dharampeth M. P. Deo Memorial
Science College, Nagpur.



DHARAMPETH M. P. DEO MEMORIAL SCIENCE COLLEGE, NAGPUR
INTERNAL QUALITY ASSURANCE CELL (IQAC)

Activity Report

Date: 30.11.22

Name of Organizing Department or Committee: Department of Home-Science

Name of the activity: Workshop on Life Skills

Suggested CRITERION point if any: I & II

Date of Activity: 23.11.22

Place of Activity: Department of Home Science

Name of Guest Speaker/s or Judge/s or Chief Guest/s if any: Dr Prajakta Kaduskar

Title of the Activity: Work shop on "Life Skills in Adolescent age".

Number of Participants: 10

Name of the Teacher In-charge / Convener: Mrs M. M. Deshpande

Names of other Committee Members / Staff: Entire Staff of Home Science Department.

OUTCOME of the Activity with respect to mission vision of the institute and or academics:

Students learn about essential Life Skills of the age. Exercises on skill Development for making life smoother Students gain the importance of attaining Life Skills.

Concept of Work Sheet for development of essential life Skills.

Activity with newspaper coverage if any: Nil

Activity data save in PC of: Mrs Manju Deshpande.

Note: Kindly share geotag photographs separately along with report on iqacdsc2022@gmail.com



Prof. Pitambar Humane
IQAC Coordinator

CO ORDINATOR
INTERNAL QUALITY ASSURANCE CELL
DHARAMPETH, M. P. DEO MEMORIAL &
SCIENCE COLLEGE, NAGPUR

Name & Signature of Teacher In-charge

Dr. Akhilesh Peshwe
Principal
PRINCIPAL

Dharampeth M. P. Deo Memorial
Science College - Nagpur-440011

DHARAMPETH M P DEO MEMORIAL SCIENCE COLLEGE

DEPARTMENT OF HOME SCIENCE

NOTICE

Students of BHSc (sem I /II/III/IV/V/VI) are informed that -----[✓] activity(lecture visit,[✓] workshop ,guest lecture, method demonstration.) will be conducted on an online/offline[✓] mode dated on 23.11.22. Attendance is compulsory.

Time: 11 am

Venue: APJ Hall

Name of Teacher Incharge

Mishra

Mishra

Head of the Department

(Department of Home science)



DHARAMPETH M. P. DEO MEMORIAL SCIENCE COLLEGE,
North Ambazari Road, Near Ambazari Lake, Nagpur- 440033

DATA VALIDATION & VERIFICATION (DVV)

Name of the Programme : Life Skill in Adolescent age
Date of the Programme : 23/11/2022
Name of Chief Guest if any : Dr. Prajakta Kaduskar
Name of Guest Speaker if any : _____

Sr. No.	Name of the Participant	Mobile Number	E-mail Id	Signature
1)	Banulal Gihongadkar	9309079427	Banulalgh@gmail.com	Banulal
2)	Pallavi B. Katre	8459277408	Pratre573@gmail.com	Pallavi
3)	Shalinam T. Madali	9022302785	Shalinammadali@gmail.com	Shalinam
4)	Puqya S. Tiwari	6394098386	Puqyatiwari1052005@gmail.com	Puqya
5)	Priya Klawshi	9763617224	Priyaktawshi3@gmail.com	Priya
6)	Prajakta A. Wakole	8459413596	prajaktawakole4@gmail.com	Prajakta
7)	Archita A. Maske	9975034151	maskearchite@gmail.com	Archita
8)	Prachi N. Lakkar	8806264419	prachilakkar15@gmail.com	Prachi
9)	Deepika R. Yadav	917099216425	elys79@gmail.com	Deepika
10)	Bhagyashree S. Ambule	9359139068	ambuleb@gmail.com	Ambule

Signature of:

Programme In-charge

INTOAC COORDINATOR
INTOAC COORDINATOR
DHARAMPETH, M. P. DEO MEMORIAL &
SCIENCE COLLEGE, NAGPUR

Principal
PRINCIPAL
Dharampeth M.P. Deo Memorial
Science College, Nagpur-440033



DHARAMPETH M. P. DEO MEMORIAL SCIENCE COLLEGE, NAGPUR
INTERNAL QUALITY ASSURANCE CELL (IQAC)
NEP Activity Report

Date:30/11/2022

Name of Organizing Department or Committee: Chemistry

Name of the activity: NEP Activity Report (SEM -III, Paper-I ,Unit-IV)

Suggested CRITERION point if any: Criteria II

Date of Activity: 23-11-2022

Place of Activity: Department of Chemistry

Name of Guest Speaker/s or Judge/s or Chief Guest/s if any- Nil

Title of the Activity: Sampling of soil of different area in Nagpur city

Number of Participants: 30

Name of the Teacher In-charge / Convener: Ms Niharika Sute

Names of other Committee Members / Staff: Dr. Mrs. V. P. Meshram

OUTCOME of the Activity with respect to mission vision of the institute and or academics:

This is a student's centric activity. These charts visually clears the concept of students about the properties and quality of various soil samples.



Activity with newspaper coverage if any: Nil

Activity data saved in PC of: Chemistry Department

Note: Kindly share Jio tag photographs separately along with report on iqacdsc2022@gmail.com

Prof. Pitambar Humane
IQAC Coordinator

CO ORDINATOR
INTERNAL QUALITY ASSURANCE CELL
DHARAMPETH, M. P. DEO MEMORIAL &
SCIENCE COLLEGE, NAGPUR

Niharika A. Sute
Name & Signature of Teacher In-charge

Dr. Akhilesh Peshw
Principal

PRINCIPAL
Dharampeth M. P. Deo Memorial
Science College, Nagpur-441111



DHARAMPETH M. P. DEO MEMORIAL SCIENCE COLLEGE,
North Ambazari Road, Near Ambazari Lake, Nagpur- 440033

DATA VALIDATION & VERIFICATION (DVV)

Name of the Programme : NEP Activity (sampling of soil of different area in nagpur city.
(Sem III, paper I, unit-IV)

Date of the Programme : 23/11/2022

Name of Chief Guest if any : _____

Name of Guest Speaker if any : _____

Sr. No.	Name of the Participant	Mobile Number	E-mail Id	Signature
1)	Vaishnavi Gadge	9026163222	vaishnavi@bimal.com	
2)	Karsh Kadape	9620301166	Karshkadape@gmail.com	
3)	Sakshi Meshram	9726168092	sakshim@gmail.com	
4)	Jaganti Warkar	8296103040	jagantiul@gmail.com	
5)	Vaishnavi Bedade	9026163222	vaishnavi@gnail.com	
6)	Aditya Tiwari	9823195700	Atiwari@gmail.com	
7)	Smit Sandebuche	9275829520	Smit@gmail.com	
8)	Darshana Madani	9665829210	darshana@gmail.com	
9)	Vedant Bary	9881057525	vedant@gmail.com	
10)	Pranachand Vaisrade	8080296917	pranachand@gmail.com	

Signature of:

Programme In-charge

IQAC Coordinator

CO ORDINATOR
INTERNAL QUALITY ASSURANCE CELL
DHARAMPETH, M. P. DEO MEMORIAL &
SCIENCE COLLEGE, NAGPUR

Principal

PRINCIPAL
Dharampeth M.P. Deo Memorial
Science College, Nagpur-440033



DHARAMPETH M. P. DEO MEMORIAL SCIENCE COLLEGE,
North Ambazari Road, Near Ambazari Lake, Nagpur- 440033

DATA VALIDATION & VERIFICATION (DVV)

11)	Siddharth G. Hiskane	9579092937	hiskanesiddharth1234@gmail.com	
12)	Jyoti J. Sharma	8669736380	jyoti58390@gmail.com	
13)	Jasraj Demilal Palival	9320820325	jasrajpalivalh7@gmail.com	
14)	Praswal S. Bhoyar	8210434634	Praswalb738@gmail.com	
15)	AMAN ANIL DONGRE	7709217312	amandongre2003@gmail.com	
16)	Kalpna D. Suhagpure	9579236712	KalpnaD.Suhagpure76@gmail.com	
17)	Nupur M. Sharma	9822042259	nupursharma258@gmail.com	
18)	Sania A. Raza	8975726700	midhatiansa@gmail.com	
19)	Nikita J. Kalle	9067324988	kallonikita59@gmail.com	
20)	Sakshi S. Meshram	9145355133	sakshimeshram90@gmail.com	
21)	Mansi J. Mate	8468891807	mansi19182@gmail.com	
22)	Tina B. Rahangdale	9021776769	tinarahangdale@caher	
23)	Vaishnavi R. Lakhe	8669594864	chhakuvi.lakhe536@gmail.com	
24)	Chhakuvi G. Wadikar	9325047907	Chhakuvi.Wadikar@gmail.com	
25)	Juhi S. Chaudhari	8669248946	chaudharijuhu12@gmail.com	
26)	Kajal P. Nighat	9373250629	kajunighat2000@gmail.com	
27)	Gargi I. Hodge	7972076671	gargihodge@gmail.com	
28)	Uamita Y. Bhande	9370643867	bhandevamita.2000@gmail.com	
29)	Shravya Dhawale	8888264004	shravyadhawale.124@gmail.com	
30)	Vaibhavi Shende	9080560282	vaibhavishende97@gmail.com	
31)	Shyamal Narare	9850827622	shyamaln@gmail.com	

Signature of:
Programme In-charge

COORDINATOR

INTERNAL QUALITY ASSURANCE CELL
DHARAMPETH, M. P. DEO MEMORIAL &
SCIENCE COLLEGE, NAGPUR

Principal

PRINCIPAL

Dharampeth M.P. Deo Memorial
Science College, Nagpur-440033



DHARAMPETH M. P. DEO MEMORIAL SCIENCE COLLEGE, NAGPUR
INTERNAL QUALITY ASSURANCE CELL (IQAC)

Activity Report

Date: 25/11/2022

Name of Organizing Department or Committee: Chemistry

Name of the activity: Industrial Visit

Suggested CRITERION point if any: Criteria II

Date of Activity: 24/11/2022

Place of Activity: Thermal Power Station, Khursapar and Purti Sugar Industry, Bela

Name of Guest Speaker/s or Judge/s or Chief Guest/s if any: Nil

Title of the Activity: Industrial Visit for Sem V students

Number of Participants: 69

Name of the Teacher In-charge / Convener: Dr. Vaishali P. Meshram

Names of other Committee Members / Staff: Dr. Sandip Bhiwagade, Ms. Niharika Sute, Mr. Sudhir Chaudhary, Mr. Santosh Maske and Mr. Amol Tambe

OUTCOME of the Activity with respect to mission vision of the institute and or academics:

Activity with newspaper coverage if any: Nil

Activity data save in PC of: Chemistry

Note: Kindly share geotag photographs separately along with report on iqacdsc2022@gmail.com



Prof. Pitambar Humane
IQAC Coordinator

CO ORDINATOR
INTERNAL QUALITY ASSURANCE CELL
DHARAMPETH, M. P. DEO MEMORIAL &
SCIENCE COLLEGE, NAGPUR

Name & Signature of Teacher In-charge

Dr. Akhilesh Peshwe
Principal

PRINCIPAL
Dharampeth M.P. Deo Memorial
Science College, Nagpur-440033

Intentional Visit
2022-2023

nbox : Read Mail [[Back to Inbox](#)]

 [Printable Format](#) | [Show full Headers](#)



From: Vijay Ambatkar <vijay.ambatkar@gmail.com> | [Add to Address book](#) | [This is spam](#)

To: "vaishali296@rediffmail.com" <vaishali296@rediffmail.com>, principal_dsc@rediffmail.com

Subject: Fwd: Your request letter dtd 16/11/2022 for permission for study visit to our plant on 24/11/2022

Date: Tue, 22 Nov 2022 13:59:39 IST

----- Forwarded message -----

From: Vijay Ambatkar <vijay.ambatkar@gmail.com>

Date: Tue, 22 Nov 2022 at 13:55

Subject: Your request letter dtd 16/11/2022 for permission for study visit to our plant on 24/11/2022

To:

Cc: kkf.iepl@gmail.com, Ashok Malik <akm.iepl@gmail.com>, Hanhar Zade <hbz.iepl@gmail.com>

Kind Atten ; Dr. Vaishali Meshram, Associate Professor and HOD of Chemistry Department, M.P. Deo Memorial Science College, , Near Ambazari Garden , Nagpur - 440033

Res. Madam,

With reference to your letter dtd 16/11/2022 for permission for (B.Sc. 3rd Year students) study visit to our Ideal Energy Projects Ltd,(IEPL) 270 MW Coal based Thermal Power Plant at Bela Nagpur, our Chief Executive Officer of the company has kindly consented and granted permission for the visit following Terms and Conditions .

1. Study visit day will be Thurs day 24 th ,Nov 2022 at the Bela Power Plant.
2. At the time of visit you should carry 1) your request letter , 2) our permission letter. 3) List of students along with Identity Card 4) List of Teacher and staff .
3. Each and every visitors should follow the safety precautions /instructions of the plant during the visit . As far as Safety point of view every visitor shall have to bare own risk, responsibility, cost and consequences during the plant visit.
4. Your study visit shall be restricted to D.M. Plant as per request letter.
5. Shri Zade HOD of Chemistry Department will give information all about D. M. Plant .
6. Shri Ambatkar Welfare Officer will work as a coordinator for this visit.
7. No photo permissible to the visitor inside the plant.

We are very much thankful to you for the interest shown in our organisation.

Vijay Ambatkar
Welfare Officer
Ideal Energy Projects Ltd.,



Dharampeth Education Society's
**DHARAMPETH M. P. DEO MEMORIAL
SCIENCE COLLEGE**

Near Ambazari Lake, North Ambazari Road, Nagpur 440 033 (M.S.)
Contact : +91 712 2241372 / 2241490 Fax +91 712 2241125
www.dharampethscience.com
NAAC Accredited - A grade (3.01)

DR. AKHILESH V. PESHWE
M.A., M.Ed. (Jr), U.R. Ph.D.
PRINCIPAL

Contact : +91 94223 13334
Email : principal_dsc@rediffmail.com

Letter No. : DSC/SR/JR/.....

Date : 16/11/2022

To,

The Project Officer

Ideal Energy Projects Ltd, Power Ltd Power Station in
Khursapar
Maharashtra

Subject: Permission for Visit.

Dear Sir,

Greeting from the staff and students of Dharampeth M. P. Deo Memorial Science College, Nagpur. We the staff and students of Chemistry department are very interested in visiting you esteemed Organization/ Company / Research Lab on 24th November 2022.

I, hope that this date will be convenient for you.

I am, sure that, this will be an enriching experience for our students and staff.

Kindly grant permission for this visit.

Thank you so much in anticipation of your kind consideration.

With regards .

Principal

Dr. Akhilesh V. Peshwe
Principal
Dharampeth M.P. Deo Memorial
Science College, NAGPUR



DHARAMPETH M. P. DEO MEMORIAL SCIENCE COLLEGE,
North Ambazari Road, Near Ambazari Lake, Nagpur- 440033

DATA VALIDATION & VERIFICATION (DVV)

Industrial visit for sem V students
Name of the Programme : Thermal Power station Khurapur, Puri Sugar Industry
Date of the Programme : Industrial visit - 24/11/2022 Bela.
Name of Chief Guest if any : -
Name of Guest Speaker if any : -

Sr. No.	Name of the Participant	Mobile Number	E-mail Id	Signature
1)	Tanmay Bhute	7697250831	tanmaybhute900@gmail.com	Tanmay
2)	Damini M. Bandbuche	8275105785	bandbuche.damini@gmail.com	D. Bandbuche
3)	Neha. A. Waghade	7249895144	nehawaghade16082002@gmail.com	N. Waghade
4)	Anjali N. Chasde	8261964188	anjalichasde20@gmail.com	A. Chasde
5)	Meunali R. Sonbaxe	9850163812	Sonbaxemeunali16@gmail.com	M. Sonbaxe
6)	Priyanka L. Gujwara	9579263881	priyankagujwara2002@gmail.com	P. Gujwara
7)	Amisha R. Ande	8767618394	amur1016@gmail.com	A. Ande
8)	Jayshree D. Hiwase	7385473157	Jshihiwase10@gmail.com	J. D. Hiwase
9)	Chetan Kamthe	3637271601	Kamthechetan6@gmail.com	C. Kamthe
10)	Suraj B. Shende	9356666487	Surajbshende2019@sjheri2001.com	S. Shende

Signature of:

Programme In-charge

COORDINATOR

INTERNAL QUALITY ASSURANCE CELL
DHARAMPETH, M. P. DEO MEMORIAL &
SCIENCE COLLEGE, NAGPUR

Principal

Dharampeth M. P. Deo Memorial
Science College, Nagpur-440033



DHARAMPETH M. P. DEO MEMORIAL SCIENCE COLLEGE,
North Ambazari Road, Near Ambazari Lake, Nagpur- 440033

DATA VALIDATION & VERIFICATION (DVV)

11)	Prachi K. Vansubhe	9325336932	prachivansubh@gorath.com	Prachubhe
12)	Neha R. Khawase	8766738340	neha2002.kk@gmail.com	Khawase
13)	Tanmay Bhute			
14)	Vanshika C. Yede	7558244609	vanshikayedese@gmail.com	Yede
15)	Sakshi V. Chamate	7709204833	chamate.sakshi26@gmail.com	Sakshi
16)	Akansha S. Bhute	9356964121	akansha2020b@gmail.com	ABhute
17)	Amit J. Wale	9168406253	amitwale440divya@gmail.com	Amit
18)	Asha S. Lantge	9922231551	ashashantantgecode@gmail.com	Ashantantge
19)	Nitin L. Masinkhede	9561179324	nasinkhedevijay@gmail.com	Nitin
20)	Prutham Premkumar Gupta	8767875919	Pruthamgupta76@gmail.com	Prutham
21)	Kaustubh R. Ramteke	7218487714	ramteke1kaustubh1900@gmail.com	Kaustubh
22)	Anjali R. Mishra	9379948106	am38654@gmail.com	Anjali
23)	Suhriya Patte	7757871925	PatteSuhriya023@gmail.com	Patte
24)	Sonam M. Uprade	9890230462	upradesonam@gmail.com	Suprade
25)	Kaashik Adlakha	8530197157	kadlakha@gmail.com	Kaashik
	Sushila S. Puri	7507439390	SushilaPuri224@gmail.com	Sushila

Signature of:

Programme In-charge

CO-ORDINATOR

INTERNAL QUALITY ASSURANCE CELL
DHARAMPETH, M. P. DEO MEMORIAL &
SCIENCE COLLEGE, NAGPUR

Principal

PRINCIPAL

Dharampeth M.P. Deo Memorial
Science College, Nagpur-440033



DHARAMPETH M. P. DEO MEMORIAL SCIENCE COLLEGE,
North Ambazari Road, Near Ambazari Lake, Nagpur- 440033

DATA VALIDATION & VERIFICATION (DVV)

26)	Rakhi. P. Gedam	7378312509	gedamrakhi2000@gmail.com Rakhi
27)	Prachi K Varabhe	9325336932	Prachivarabhe@gmail.com Prachi
28)	Laxmi G. Sayam	7517799645	Sayam Laxmi 889@gmail.com Laxmi
29)	Tejal Mankar	9822458697	Tejalmankar933@gmail.com TEJAL
	Pratibha L. Gujwar	9579263881	Pratibhagujwar2003@gmail.com Pratibha
30)	Dolly B Gadhane	9284264236	dollygadhane@gmail.com Dolly
31)	Aspita T. Dakhale	8010866758	aspitadakhale@gmail.com Dakhale
32)	Meenali R. Borsare	9850163812	Borsaremeenali16@gmail.com Meenali
33)	Anshuman sharma	9370892462	anshuraanshumas14@gmail.com Anshuman
34)	Vishal Kumar Singh	9610187223	vishal.kumar.singh12@gmail.com Vishal
35)	Megha fulwani	8605379918	meghafulwani01@gmail.com Megha
36)	Prajwal Murgle	9934234902	prajwalmurgle123@gmail.com Murgle
37)	Saiya Naik	9370570457	saiyanai15@gmail.com Saiya
38)	Pallavi Y. Bhagat	9022654940	Pallavi2205@gmail.com Bhagat
39)	Sakshi P. Mankar	8180816539	Sakshi2018mmmm@gmail.com Mankar
4)			

Signature of:

Programme In-charge

CO ORDINATOR
INTERNAL QUALITY ASSURANCE CELL
DHARAMPETH, M. P. DEO MEMORIAL &
SCIENCE COLLEGE, NAGPUR

Principal
DHARAMPETH M. P. DEO MEMORIAL
SCIENCE COLLEGE, NAGPUR-440033



DHARAMPETH M. P. DEO MEMORIAL SCIENCE COLLEGE,
North Ambazari Road, Near Ambazari Lake, Nagpur- 440033

DATA VALIDATION & VERIFICATION (DVV)

Name of the Programme : Industrial visit for sem V students, Khuseapal, Puniti sagar
Date of the Programme : 24/11/2022
Name of Chief Guest if any : —
Name of Guest Speaker if any : —
Industry Bela

Sr. No.	Name of the Participant	Mobile Number	E-mail Id	Signature
40)	Kartik Adbhikhi	8530597169	k-adbhikhi@gmail	<u>Kartik</u>
41)	Megha Fulwax	9605399606	megha.fulwax@gmail.com	<u>Megha Fulwax</u>
42)	Supriya Patle	7757871425	PatleSupriya123@gmail.com	<u>Patle</u>
43)	Sushila S. Purohi	7507439390	sushilapurohi224@gmail.com	<u>Sushila</u>
44)	Sonam M. Uprade	9890230462	upradesonam@gmail.com	<u>Uprade</u>
45)	Anjali N. Charde	8261964188	anjalicharde20@gmail.com	<u>A Charde</u>
46)	chetan Kamthe	9637271601	kamthechetan6@gmail.com	<u>Kamthe</u>
47)	Suroj Shende	9356666489	Surojbshende123@gmail.com	<u>Suroj</u>
48)	Dolly B Gabbhane	9284264236	dollygabbhane7@gmail.com	<u>Gabbhane</u>
49)	Anjali . R. Mishra	8319948106	am38654@gmail	<u>Anjali</u>

Signature of:

Programme In-charge

IQAC Coordinator
CO ORDINATOR

INTERNAL QUALITY ASSURANCE CELL
DHARAMPETH, M. P. DEO MEMORIAL &
SCIENCE COLLEGE, NAGPUR

Principal
Dharampeth M.P. Deo Memorial
Science College, Nagpur-440033



DHARAMPETH M. P. DEO MEMORIAL SCIENCE COLLEGE,
North Ambazari Road, Near Ambazari Lake, Nagpur-440033

DATA VALIDATION & VERIFICATION (DVV)

50)	Neha. A. Waghade	7249895144	nehawaghade16082002@gmail.com (Waghade)
51)	Rakhi. P. Gedam	7378312504	gedamrakhi2009@gmail.com (Gedam)
52)	Laxmi G. Sayam	4517793675	Sayamlaxmi389@gmail.com (Sayam)
53)	Tejesh Mankar	9322458697	Tejeshmankar933031@gmail.com (Mankar)
54)	Vanshika. C. Xede	7558244609	vanshikaxede1@gmail.com (Xede)
55)	Brechi K. Varabhe	9325336932	BrechiVarabhe@gmail.com (Varabhe)
56)	Akanksha. S. Bhude	9356964121	akankshas2020@gmail.com (Bhude)
57)	Priyanka L. Gujwar	9579263881	priyankagujwar2000@gmail.com (Gujwar)
58)	Amisha R. Ande	8767618394	amur1016@gmail.com (Ande)
59)	Aspita T. Dakhale	8010866758	aspitadakhale02@gmail.com (Dakhale)
60)	Meunali R. Sonsewar	9850163812	Sonsewarmeunali@gmail.com (Sonsewar)
61)	Jayashree D. Hiwase	7385473157	Jayashree1@gmail.com (Hiwase)
62)	Kaustubh. R. Ramteke	7218487719	ramtekekaustubh2002@gmail.com (Ramteke)
63)	Anshuman. G. Sharma	9370892462	Anshumansharma@gmail.com (Sharma)
64)	Vaishnavi R. Chandekar	7249882964	vaishnavi@gmail.com (Chandekar)

Signature of

Programme In-charge

CO-ORDINATOR
INTERNAL QUALITY ASSURANCE CELL
DHARAMPETH, M. P. DEO MEMORIAL &
SCIENCE COLLEGE, NAGPUR

PRINCIPAL

Dharampeth M.P. Deo Memorial
Science College, Nagpur-440033



DHARAMPETH M. P. DEO MEMORIAL SCIENCE COLLEGE,
North Ambazari Road, Near Ambazari Lake, Nagpur- 440033

DATA VALIDATION & VERIFICATION (DVV)

65)	Anshuman sharma	9370892462	anshuman.sharma.534@gmail	Asharma
66)	Vishal Kumar Singh	9610187293	Vishal.kumar.singh12@gmail	Vsingh
67)	saniya Naik	9370570457	saniyanaiks1@gmail.com	Shalle
68)	Pragwal Murgle	983423902	prajwalmurgle12@gmail.com	Pr
69)	Shubham P Khindrajade	9518788915	shubhamkhindrajade120@gmail.com	shubham
70)	Pallavi Y. Bhagat	9022654940	Pallaviy2208@gmail.com	Bhagat

Signature of

Programme In-charge

IQAC Coordinator
CO ORDINATOR
INTERNAL QUALITY ASSURANCE CELL
DHARAMPETH, M. P. DEO MEMORIAL &
SCIENCE COLLEGE, NAGPUR

Principal
PRINCIPAL
Dharampeth M.P. Deo Memorial
Science College, Nagpur-440033



DHARAMPETH M. P. DEO MEMORIAL SCIENCE COLLEGE, NAGPUR

INTERNAL QUALITY ASSURANCE CELL (IQAC)

Activity Report

Date: 8/12/2022

Name of Organizing Department or Committee: Department of Mathematics

Name of the activity: NEP based find the real life applications of partial differential equations for B.Sc. Semester-III

Suggested CRITERION point if any: Criterion I,

Date of Activity: 6/12/2022

Place of Activity: Class room

Name of Guest Speaker/s or Judge/s or Chief Guest/s if any: NA

Title of the Activity: Find the real life applications of partial differential equations

Activity with newspaper coverage if any: No

Number of Participants: B.Sc. Semester-III Students (45)

Name of the Teacher In-charge / Convener: Dr. N. P. Gaikwad

Names of other Committee Members / Staff: N.A.

OUTCOME of the Activity with respect to academics:

This activity provided an opportunity to B.Sc. Semester-III students to the real life applications of partial differential equations. Partial Differential Equations are used to mathematically formulate, and thus aid the solution of, physical and other problems involving functions of several variables, such as the propagation of heat or sound, fluid flow, elasticity, electrostatics, electrodynamics, thermodynamics, etc.

This activity helped students to understand the real life applications of partial differential equations.

DVV: Enclosed.

Prof. Pitambar Humane

IQAC Coordinator

CO ORDINATOR
INTERNAL QUALITY ASSURANCE CELL
DHARAMPETH, M. P. DEO MEMORIAL &
SCIENCE COLLEGE, NAGPUR

Dr. N. P. Gaikwad
Name & Signature of Teacher In-charge

Dr. Ajitesh Peshwe

Principal

Principal
Dharampeth M.P. Deo Memorial
Science College, Nagpur.



DHARAMPETH M. P. DEO MEMORIAL SCIENCE COLLEGE,
North Ambazari Road, Near Ambazari Lake, Nagpur- 440033

DATA VALIDATION & VERIFICATION (DVV)

Name of the Programme : Find the real life applications of partial diff. eqⁿ
 Date of the Programme : 06/12/2022
 Name of Chief Guest if any : -
 Name of Guest Speaker if any : -

Sr. No.	Name of the Participant	Mobile Number	E-mail Id	Signature
1	Nikita I. Kallu	9061324988	kallonikita54@gmail.com	
2	Shital R. Ketzeekar	9373389723	shital2ezekka@gmail.com	
3	Prachit R. Kotpalliwade	7498102097	prachitkotpalliwade@gmail.com	
4	Aasmin Khalik Sheikh	8668323588	aasmin5029@gmail.com	
5	Sejal R. Lakhaupal	9028851568	sejal.lakhaupal@gmail.com	
6	Kajal P. Nighot	9373250623	kajalnighot2606@gmail.com	
7	Devang. Karia	7888238500	laddudhara@gmail.com	
8	Jasraj D. Palival	9370820325	jasrajpalival47@gmail.com	
9	Hitesh G. Kausare	7058427112	hiteshkousare73@gmail.com	
10	Ankur Khurpadi	7249884629	khurpadiankur@gmail.com	
11	Rushikesh D. Hambarde	9028225874	rushikeshhambarde33@gmail.com	
12	Kemal S. Digoswale	8010276303	kemaldigoswale777@gmail.com	

Programme In-charge

IQAC Co-ordinator
Dharampeth M.P. Deo Memorial
Science College, Nagpur-440033

Principal
Dharampeth M.P. Deo Memorial
Science College, Nagpur.



DHARAMPETH M. P. DEO MEMORIAL SCIENCE COLLEGE,
North Ambazari Road, Near Ambazari Lake, Nagpur- 440033

DATA VALIDATION & VERIFICATION (DVV)

13	Ritik M. Daware	93567114234	ritik1929@gmail.com	R-Daware
14	Ritik N. Gajbhiye	7620826960	ritik.gajbhiye05@gmail.com	Rit
15	Aditya Kumar Singh	7350543901	adityasingh288180@gmail.com	A.K.S
16	Dinesh I. Parate	9623389676	ParateDinesh51@gmail.com	D
17	Vicky A. Singh	9834782931	vickysingh11032001@gmail.com	V
18	Yash R. Khandekar	7020929422	yashkhandekar5@gmail.com	Y
19	Chetan V. Bopche	9172484628	Chetanbopche21@gmail.com	C
20	Rahul Kawade	9359525716	KawadeRahul09@gmail.com	R
21	Isha Nemade	7028494761	ishanemade72@gmail.com	I
22	Harshal Ajankar	9527732348	Harshalajankar8@gmail.com	H.A.
23	Ketan Bhojare	9657957276	Ketanbhojare76@gmail.com	K
24	Kajal Prasad	7410763138	prasadkajal2006@gmail.com	K
25	Bhagyavathi Pandey	9175302601	pandeybhagyavathi@gmail.com	B.Pandey
26	Shweta Bedwal	8080440184	ShwetaBedwal2605@gmail.com	S
27	Rishi Kisen	7028910540	rishikisen06@gmail.com	R
28	Mansi Nandanwar	7709372027	mansinandanwar@gmail.com	M
29	Sarthak Jichkar	860750858	SarthakJichkar@gmail.com	Sarthak
30	Smit Sakle	9322410388	SmitSakle0506@gmail.com	S
31	Jay A Patil	7385436066	Jay.Patil10326@gmail.com	J

Programme In-charge

IQAC Coordinator
IQAC Co-ordinator

Dharampeth M.P. Deo Memorial
Science College, Nagpur-440033

Principal

Dharampeth M.P. Deo Memorial
Science College, Nagpur.



DHARAMPETH M. P. DEO MEMORIAL SCIENCE COLLEGE,
North Ambazari Road, Near Ambazari Lake, Nagpur- 440033

DATA VALIDATION & VERIFICATION (DVV)

32	Kavita Mishra	9657199201		Aishwari
33	Divya Hanote	860542290	divyahanote2406@gmail.com	Divya
34	Prachinna Singh	7666939940	prachinna.singh@pebbles2019.com	Prachinna
35	Adityakumar Singh Shukla	9516994635	adityashukla002@gmail.com	Aditya
36	Nupur Sharma	9322042259	Nupursharma258@gmail.com	Nupur
37	Nitin kushwaha	9693429005	nitinkushwaha07@gmail.com	Nitin
38	Renuka Lanale	7719951401	renukalanale20@gmail.com	Renuka
39	Aditi kute	7820812303	aditikutekar@gmail.com	Aditi
40	Sanchit Kupte	9218099044	sanchitkupte12003@gmail.com	Sanchit
41	Damini Katre	8208255685	daminikatre31@gmail.com	Damini
42	Ananya Motghare	7219218955	ananya.motghare@gmail.com	Ananya
43)	Umeshwari Kulkarni	9166916355	1130806593@gmail.com	Umeshwari
44)	Gaurav Landge	7767854087	gauravlandge@gmail.com	Gaurav
45)	Akshay Khandare	7350956109	Akshaykhandare79@gmail.com	Akshay

Signature of:

Programme In-charge

IQAC Coordinator
Dharampeth M.P. Deo Memorial
Science College, Nagpur-440033

Principal
Dharampeth M.P. Deo Memorial
Science College, Nagpur.



DHARAMPETH M. P. DEO MEMORIAL SCIENCE COLLEGE, NAGPUR
INTERNAL QUALITY ASSURANCE CELL (IQAC)

Activity Report

Date: 26-11-2022

Name of Organizing Department or Committee: Value Addition Committee

Name of the activity: Guest Lecture on The Importance and Awareness of the constitution.

Suggested CRITERION point if any: 1 & 5

Date of Activity: 26-11-2022

Place of Activity: A.P. J. Abdul Kalam Hall

Name of Guest Speaker/s or Judge/s or Chief Guest/s if any: Shri. Sunilji Kitkaru, organizer, Bhartiya vichar manch, Nagpur.

Title of the Activity: Samvidhan Diwas

Number of Participants: 36

Name of the Teacher In-charge / Convener: Prof. Varsha Rangari

Names of other Committee Members / Staff: Mrs. Sujata Ali, Dr. R Pashine, Mrs. A. Shiledar, Mrs. Dipti Iyer, Mrs. Priyanka Joshi, Mrs. S. Jawade, Mrs. A. Gadewar, Mrs. M. Zhalke, Mrs. K. Kodape, Mr. H. Kolhe, Dr. R. Kalode.

OUTCOME of the Activity with respect to mission vision of the institute and or academics:

The Value Addition Committee of the college celebrated the Samvidhan diwas on 26/11/2022 in A. P. J Abdul Kalam hall. First the oath of the proposal of the constitution was taken together. The Guest Speaker Shri. Sunilji Kitkaru, organizer, Bhartiya vichar manch, Nagpur spoke on "The Importance and Awareness of the constitution". Dr. Akhilesh Peshwe, Principal of the college thanked the speaker. Dr. Vidya Kathoke madam conducted the program. Mrs. Anjali Thombre activist, IQAC coordinator Prof. Humane, Mrs. Kashiker Vice Principal Junior College, teaching and non-teaching Staff members and students were present on this occasion.

Activity with newspaper coverage if any: No

Activity data save in PC of: Prof V. V. Rangari



Note: Kindly share geotag photographs separately along with report on igacdsc2022@gmail.com

Prof. Pitambar Humane
IQAC Coordinator

CO ORDINATOR
INTERNAL QUALITY ASSURANCE CELL
OLKARAMPETH, M. P. DEO MEMORIAL &
SCIENCE COLLEGE, NAGPUR

Name & Signature of Teacher In-charge

Dr. Akhilesh Peshwe
Principal
Principal
Olkarampeth M.P. Deo Memorial
Science College, NAGPUR



DHARAMPETH M. P. DEO MEMORIAL SCIENCE COLLEGE,
North Ambazari Road, Near Ambazari Lake, Nagpur- 440033

DATA VALIDATION & VERIFICATION (DVV)

Name of the Programme

Samvidhan Divas

Date of the Programme

26/11/2022

Name of Chief Guest if any

—

Name of Guest Speaker if any

Shri. Sunilji Kittkar, organizes, Bharhya Vichar Manch.

Sr. No.	Name of the Participant	Mobile Number	E-mail Id	Signature
1.	Gangy' Nadge	7972076671	gangyhadge@gmail.com	Gangy
2.	Vaishnavi Gadge	9022976449	gadyvaishnavi@gmail.com	Vgad
3.	Harsh Kodape	9604677672	harshkodape008@gmail.com	Harsh
4.	Prajwal Bhoyar	8010934634	prajwalb738@gmail.com	Praj
5.	Harshad Warthi	7414993575	harshadwarthi869@gmail.com	Harshad
6.	Sahil Singh	7258868502	sahilsingh76@gmail.com	Sahil
7.	Jagzuti D. Wankar	7447366023	Jagzutiwankar@gmail.com	Jagzuti
8.	Juhi Chandhavi	8669261944	chandhavijuhi120@gmail.com	Juhi
9.	Mansi Mate	8468891807	mansi1918@gmail.com	Mansi
10.	Sakshi Mesharam	9145851733	sakshimesharam240@gmail.com	Sakshi

Signature of:

Program In-charge

COORDINATOR
INTERNAL QUALITY ASSURANCE CELL
DHARAMPETH, M. P. DEO MEMORIAL &
SCIENCE COLLEGE, NAGPUR

Principal
Dharampeth M.P. Deo Memorial
Science College, NAGPUR



DHARAMPETH M. P. DEO MEMORIAL SCIENCE COLLEGE,
North Ambazari Road, Near Ambazari Lake, Nagpur- 440033

DATA VALIDATION & VERIFICATION (DVV)

Name of the Programme : Samvidhan Divas
Date of the Programme : 26/11/2022
Name of Chief Guest if any : —
Name of Guest Speaker if any : Shri. Sunilji Kittkari, organizes, Bharatiya Vichar Manch.

Sr. No.	Name of the Participant	Mobile Number	E-mail Id	Signature
1.	Gargi Nadge	7972076671	garginadge@gmail.com	
2.	Vaishnavi Gadge	9022976669	gadge.vishnavi@gmail.com	
3.	Harsh Kodape	9604677672	harshkodape000@gmail.com	
4.	Prajwal Bhoyar	8010934634	prajwalb738@gmail.com	
5.	Harshad Warthi	7414993575	harshadwarthi369@gmail.com	
6.	Sahil Singh	7258868502	sahilsingh76@gmail.com	
7.	Jagruti D. Wankar	7447366023	jagruticwankar@gmail.com	
8.	Juhi Chaudhari	8669268964	chaudharijuhi120@gmail.com	
9.	Mansi Mate	8468891807	mansi9188@gmail.com	
10.	Sakshi Mesharam	9145851733	sakshimesharam210@gmail.com	

Signature of:

Program In-charge

COORDINATOR
INTERNAL QUALITY ASSURANCE CELL
DHARAMPETH, M. P. DEO MEMORIAL &
SCIENCE COLLEGE, NAGPUR

Principal
Dharampeth M.P. Deo Memorial
Science College, NAGPUR



DHARAMPETH M. P. DEO MEMORIAL SCIENCE COLLEGE,
North Ambazari Road, Near Ambazari Lake, Nagpur- 440033

DATA VALIDATION & VERIFICATION (DVV)

11	Somir Ghumde	9359236913	somirghumde2002@gmail.com	Ghumde
12	Rinam C. Wankhede	8010966529	wankhedorinamof@gmail.com	Wankhede
13	Madhura U. Bhondwe	8767484914	madhuraubhondwe@gmail.com	Bhondwe
14	Shruti Pawar	9527988707	shrutipawar@gmail.com	Simpawar
15	Roshani Bambal	9325853408	Roshani2018bh@gmail.com	Bambal
16	Manal Chaudhary	9529014604	manalchaudhary100@gmail.com	Chaudhary
17	Shreyansh S. Nalkwad	7447844189	shreyansh.nalkwad@gmail.com	Nalkwad
18	Samiksha R. Choudhary	7517090406	choudharysamiksha26@gmail.com	Choudhary
19	Anjali R. Pali	7498102109	paliyanjali46@gmail.com	Pali
20	Ayushi Shukla	9373668093	ayushishukla28112002@gmail.com	Shukla
21	Samiksha N. Kundekar	9145253758	Samiksha.kundekar@gmail.com	Kundekar
22	Sayali Lokhande	9356413804	Sayalilokhande2910@gmail.com	Lokhande
23	Nandini Hodge	9370301679	nandininodg@gmail.com	Hodge
24	Bhargavi Sambare	7709403806	bhargavisambare05@gmail.com	Sambare
25	Ishika S. Thakre	8010907069	ishithakre22@gmail.com	Thakre

Signature of:

Programme in-charge

COORDINATOR
INTERNAL QUALITY ASSURANCE CELL
DHARAMPETH, M. P. DEO MEMORIAL &
IQAC SCIENCE COLLEGE, NAGPUR

Principal
Dharampeth M.P. Deo Memorial
Science College, NAGPUR
Principal



DHARAMPETH M. P. DEO MEMORIAL SCIENCE COLLEGE,
North Ambazari Road, Near Ambazari Lake, Nagpur- 440033

DATA VALIDATION & VERIFICATION (DVV)

Name of the Programme : Samvidhan Divas
Date of the Programme : 26/11/2022
Name of Chief Guest if any : -
Name of Guest Speaker if any : Shri. Sunilji Kittar, organizer, Bharatiya Videsh Manch.

Sr. No.	Name of the Participant	Mobile Number	E-mail Id	Signature
01)	Ku. Vishakha Karkhedkar	9921139330	vkrskhedkar@	26/11/22
02)	Mrs. Madhuri A. Zalke	9404087466	zalkem-9@yahoo.co.in	
03)	Mrs. Khushi S. Kodape	8698959421	khushi_pigeon@yahoo.co.in	
04)	Amit P. Kulkarni	8600678848		
05)	Aniket Siraswan	9284309930	Siraswan1997@gmail.com	
06)	Pratishtha N. Chakrabarti	9096669524		
07)	Kapil D. Mandawar	9096887713	Kapil-mandawar@gmail.com	

Signature of:

Program Manager in Charge

COORDINATOR
INTERNAL QUALITY ASSURANCE CELL
DHARAMPETH, M. P. DEO MEMORIAL &
SCIENCE COLLEGE, NAGPUR

Principal
Dharampeth M.P. Deo Memorial
Science College, NAGPUR



DHARAMPETH M. P. DEO MEMORIAL SCIENCE COLLEGE, NAGPUR
INTERNAL QUALITY ASSURANCE CELL (IQAC)

Activity Report

Date: 28/11/2022

Name of Organizing Department or Committee: Department of Microbiology

Name of the activity: Carbohydrate and Nucleotide structure drawing competition.

Suggested CRITERION point if any:

Date of Activity: 28/11/2022

Place of Activity: Department of Microbiology Dharampeth MP Deo Memorial Science College, Nagpur.

Name of Guest Speaker/s or Judge/s or Chief Guest/s if any: Nil

Title of the Activity: Structure drawing competition on Carbohydrate and Nucleotide structure from Paper I unit I & IV for semester III students.

Number of Participants: 49 students.

Name of the Teacher In-charge / Convener: Dr. Pratiksha V. Pohekar

Names of other Committee Members / Staff:

OUTCOME of the Activity with respect to mission vision of the institute and or academics:

- It helps to describe the basic units of the macromolecules and the types of linkages between them.
- Students will be able to recall the classification of carbohydrates into simple sugars (mono- and disaccharides) and complex sugars (polysaccharides),
- Students will be able to describe the alpha and beta structures of glucose and its properties as a hexose sugar.



Name & Signature of Teacher In-charge

Prof. Pitambar Humane
IQAC Coordinator

Dr. Akhilesh Peshwe
Principal



DHARAMPETH M. P. DEO MEMORIAL SCIENCE COLLEGE,
North Ambazari Road, Near Ambazari Lake, Nagpur-440033

DATA VALIDATION & VERIFICATION (DVV)

Name of the Programme : Carbohydrate and Nucleotide structure drawing competition.
Date of the Programme : 28/11/22 (Sem III)
Name of Chief Guest if any : Nil
Name of Guest Speaker if any : Nil

Sr. No.	Name of the Participant	Mobile Number	E-mail Id	Signature
1.	Afsina Sheikh	8080083981	afsinasheikh973@gmail.com	Sheikh
2.	Anustree chandel	9145631751	anuchandel2001@gmail	chandel
3.	Glaumi Raut	9767873447	ankusraut2003@gmail.com	Raut
4.	Smruti Vaidya	8856908764	SmrutiVaidya3@gmail.com	Vaidya
5.	Ketaki Kulkarni	9112759066	KetakiKulkarni13@gmail.com	Kulkarni
6.	Vaibhav A. Malewar	8767838219	Vaibhavmalewar794@gmail.com	Malewar
7.	Chirayu B. Dolai	8010135012	chirayudolai22@gmail.com	Dolai
8.	Prathal M. Meshram	7021735508	Prathalmeshram7@gmail.com	Meshram
9.	Siddhant G. Hirkare	9579092931	hirkaregmesiddhant1234@gmail.com	Hirkare
10.	Kalyani C. Shahare	9307046378	ShahareKalyani9@gmail.com	Shahare

Signature of:

Programme In-charge

IQAC Coordinator

Principal



DHARAMPETH M. P. DEO MEMORIAL SCIENCE COLLEGE,
North Ambazari Road, Near Ambazari Lake, Nagpur-440033

DATA VALIDATION & VERIFICATION (DVV)

11.	Vaishnavi Kapse	8983751089	vaishnavikapse@gmail.com	Vaishnavi
12.	Shital G. Bankas	7758055139	shitalbankas12@gmail.com	S.G. Bankas
13.	Swati Longadge	8390516517	swatilongadge@gmail.com	Swati
14.	Nikita S. Bhave	9860159628	nikitabhav98@gmail.com	Nikita
15.	Sagar S. Bawane	9975460979	sagarbawane637@gmail.com	S.Bawane
16.	Gergij Kodge	797207667	gergijkodge@gmail.com	Gergij
17.	Vaishnavi Gadge	9022976449	gadgevaishnavi@gmail.com	Gadge
18.	Prasanna Bhojari	8010494634	Prasanna6738@gmail.com	Prasanna
19.	Kaash Kodahe	9884677672	kaashkodahe@gmail.com	Kodahe
20.	Sumit Bhandbuche	8788212339	sumitbhandbuche10@gmail.com	Sumit
21.	Sameer Ghumde	9359286713	sameerghumde2002@gmail.com	Ghumde
22.	Aniket Kulkade	9709629106	Aniket62@gmail.com	Aniket
23.	Devesh Longadge	9326246453	Deveshlongadge@gmail.com	Devesh
24.	Mansi Mate	8468891807	mansij1982@gmail.com	Mansi
25.	Jai S. Chaudhari	8669248944	chaudharijai120@gmail.com	Jai

Signature of: _____

Signature of: _____

Principal
Dharampeth M. P. Deo Memorial
Science College, Nagpur
Principal



DHARAMPETH M. P. DEO MEMORIAL SCIENCE COLLEGE,
North Ambazari Road, Near Ambazari Lake, Nagpur- 440033

DATA VALIDATION & VERIFICATION (DVV)

26.	Rupesh Bhokre	8805887370	bhokrerupesh@gmail.com	
27.	Vaishnavi Nandpure	9322439316	vaishnavinandpure6@gmail.com	
28.	Niket Thakre	7378899087	niketthakre82@gmail.com	
29.	Urmila Bondre	9370673867	bondreurmila.2000@gmail.com	
30.	Shreya Dhawale	8888264004	shreyadhawale123@gmail.com	
31.	Vaibhavi Shende	8080640782	Vaibhavishende97@gmail.com	
32.	Jagzuti D. Warkar	7447366023	jagzutiwarkar99@gmail.com	
33.	Sakshi S. Mehram	914535733	sakshimehram210@gmail.com	
34.	Chhakuli G. Wadikar	9325047907	chhkwadikar@gmail.com	
35.	Mansi D. Raut	7385114931	Mansiraut@gmail.com	
36.	Vaishnavi R. Lakhe	8669694864	chhakulilakhe36@gmail.com	
37.	Pooja S. Itankar	9156973252	poojaitankar97@gmail.com	
38.	Tina Rahangdale	9921776769	tincarahangdale@gmail.com	
39.	Twinkal Lokhande	8149176609	twinkallokhande@gmail.com	
40.	Vaishnavi J. Bedade	8657188093	vaishnavibedade102@gmail.com	
41.	Dhanshree V. Newalkar	9356516280	newalkardhanshree@gmail.com	

Signature of:

Programme In-charge

IQAC Coordinator

Principal

Dharampeth M. P. Deo Memorial
Science College, Nagpur



DHARAMPETH M. P. DEO MEMORIAL SCIENCE COLLEGE,
North Ambazari Road, Near Ambazari Lake, Nagpur- 440033

DATA VALIDATION & VERIFICATION (DVV)

Kalpna Suhagpure	9579 236712	kalpanasuhagpure@gmail.com	Suhagpure.
Sheawani Wakhede	7058 3688 37	sheawani@gmail.com	Shea
Anjali Nishe	93256 04513	Anjali123@gmail.com	Anisha
Pallavi Borkar	9873187246	borkarpallavi98@gmail.com	P
Shubham C. Bisen	744828 9544	shubhamalbisen@gmail.com	Bisen
Rushabh M. Chaudhari	72188 62335	Rushabhchaudhari00@gmail.com	RChaudhari
Sania Nihat A Raja	8975726700	nihatania@gmail.com	N
Jyoti Sharma	8669736380	jyoti's390@gmail.com	J.Sharma

Signature of:

Program In-charge

COORDINATOR
INTERNAL QUALITY ASSURANCE CELL
DHARAMPETH M. P. DEO MEMORIAL &
SCIENCE COLLEGE, NAGPUR

Principal

Dharampeth M. P. Deo Memorial
Science College, Nagpur



DHARAMPETH M. P. DEO MEMORIAL SCIENCE COLLEGE, NAGPUR
INTERNAL QUALITY ASSURANCE CELL (IQAC)

Activity Report

Date: 30/11/2022

Name of Organizing Department or Committee: Computer Science

Name of the activity: Determination of Functional Dependencies on the given data

Suggested CRITERION point if any: V

Date of Activity: 30/11/2022

Place of Activity: Room Number 03 (College Premises)

Name of Guest Speaker/s or Judge/s or Chief Guest/s if any: NA

Title of the Activity: Determination and removal of Functional Dependencies on the given data

Number of Participants: 38

Name of the Teacher In-charge / Convener: Mrs. Ruma Kapre

Names of other Committee Members / Staff: NA

OUTCOME of the Activity with respect to mission vision of the institute and or academics:

Through the activity student studied the data provided to them. After going through the data thoroughly first they determined which type of dependency exists on the given data and by applying proper rules they removed the dependency and decompose the table so that table will be in proper normal form.

Activity with newspaper coverage if any: NA

Activity data save in PC of: Mrs. Ruma Kapre



Prof. Pitambar Humane
IQAC Coordinator

CO ORDINATOR
INTERNAL QUALITY ASSURANCE CELL
DHARAMPETH, M. P. DEO MEMORIAL &
SCIENCE COLLEGE, NAGPUR

Mrs. Ruma Kapre
Name & Signature of Teacher In-charge

Dr. Akhilesh Peshwe
Principal

Principal
Jharampeth M.P. Deo Memorial
Science College, Nagpur.



DHARAMPETH M. P. DEO MEMORIAL SCIENCE COLLEGE,
North Ambazari Road, Near Ambazari Lake, Nagpur- 440033

DATA VALIDATION & VERIFICATION (DVV)

Name of the Programme : Determination of Functional Dependencies on
Date of the Programme : 30/11/2022 given Data [SEM V & UNIT IV]
Name of Chief Guest if any : _____
Name of Guest Speaker if any : _____

Sr. No.	Name of the Participant	Mobile Number	E-mail Id	Signature
1.	Ritu L. Choudhary	8180962189	ritulalit@choudhary@gmail.com	
2.	Sujata. Phansaj. Sonwane	9021135140	sujata.sonwane2001@gmail.com	
3.	Samiksha Tabhe	9307133863	samiksha.tabhe@gmail.com	
4.	Tony S. Mohule	7057344982	tonymohule45@gmail.com	
5.	Pratiksha S. Chudhuri	7501317611	chudhuri.pratiksha2000@gmail.com	
6.	Samiksha R. Khosare	9604473539	rekhakhosare@gmail.com	
7.	Komal M. Kumbhare	7620314869	kumbharekomal44@gmail.com	
8.	Neha J. Bankar	8055477553	nehaj2002bankar@gmail.com	
9.	Rekhita S. Bhegar	9527832686	suechitabhaygar@gmail.com	
10.	Ditya R. Patil	7797052463	dityapatil553@gmail.com	

Signature of:

Programme In-charge

Mrs. Ruma Kapre

IQAC Coordinator
CO ORDINATOR
INTERNAL QUALITY ASSURANCE CELL
DHARAMPETH, M. P. DEO MEMORIAL &
SCIENCE COLLEGE, NAGPUR

Principal

Dharampeth M. P. Deo Memorial
Science College, Nagpur



DHARAMPETH M. P. DEO MEMORIAL SCIENCE COLLEGE,
North Ambazari Road, Near Ambazari Lake, Nagpur- 440033

DATA VALIDATION & VERIFICATION (DVV)

11.	Pranjal D. Sawudkar	7385458510	pranjalbaw1234@gmail.com	
12	khushi Dore	9590009937	khushi2019@gmail	khushi
13	Khushi A. Gupta	9922991235	kg098900@gmail.com	Gupta
14	Dikshita Sahanu	9028830809	dikshitasahanu	Dikshita
15	Pranay Mahajan	7385551492	Pranaymahajan3@gmail.com	Pranay
16	Rajat Rohad	9175635273		Rajat
17	mukund Hood	8604785822		M Hood
18	Aarti B. Singh	7709208740	Aartisingh222@gmail.com	Singh
19	Sahil R. Jivade	9373214645	sahiljivade73@gmail.com	Sahil
20	Pranay S. Dore	880629245	pranaydore47@gmail.com	Pranay
21	Rishikesh R. Dethle	8788199260	rishikeshdethle002@gmail.com	Rishikesh
22	Abhishek A. Falke	7823835535	abhishekfalke58@gmail.com	A Falke
23	Vishal Girhale	9673681472	vishalgirhale27@gmail.com	Vishal
24	Mahesh. P. Maske	9021951173	maheshmaske47@gmail.com	M Maske
25	Nikhil K. Jankar	8530960407	Nikhiljankar@gmail.com	Nikhil
26	Bhaves R. Maske	7489951631	bhaveshm954e2002@gmail.com	Bhaves M.

Signature of

Programme In-charge

Mrs. Ruma Kapre

IQAC Coordinator

CO ORDINATOR

INTERNAL QUALITY ASSURANCE CELL
DHARAMPETH, M. P. DEO MEMORIAL &
SCIENCE COLLEGE, NAGPUR

Principal

Principal

Dharampeth M.P. Deo Memorial
Science College, Nagpur.



DHARAMPETH M. P. DEO MEMORIAL SCIENCE COLLEGE,
North Ambazari Road, Near Ambazari Lake, Nagpur- 440033

DATA VALIDATION & VERIFICATION (DVV)

27)	Sumect Bhalekar	9021627752	sumitbhalekar262@gmail.com	S. Bhalekar
28)	Bhavesh D. Mathur	9021317056	bhaveshmathur18112001@gmail.com	Bmath
29)	Abdul Raaf Aman Shafique	7666938578	raakaman2811@gmail.com	Abdul
30)	Akash D. Das	7972072799	akashdidas@gmail.com	Akash D. Das
31)	Tanmay S. Godam	7262034396	tanmaygodam1@gmail.com	T. S. Godam
32)	Jalraj P. Pawke	9422488044	jalrajpawke001@gmail.com	Pawke
33)	Sanchit Joshi	8975706788	Sanchit.joshi02@gmail.com	SJoshi
35)	Saurabh V. Raut	9527293219	saurabhraut4923@gmail.com	S. Raut
36)	Pratik R. Shete	9356716253	pratikshete193@gmail.com	Pratik
37)	Seema Madan Lutedar	7058728070	seema (akd) 073@gmail.com	Seema
38)	Seni A. Rai	8955989508	senirunrai17@gmail.com	Seni

Signature of:

Programme In-charge

Mrs. Ruma Kapre

IQAC Coordinator

CO ORDINATOR

INTERNAL QUALITY ASSURANCE CELL
DHARAMPETH, M. P. DEO MEMORIAL &
SCIENCE COLLEGE, NAGPUR

Principal

Principal

Dharampeth M.P. Deo Memorial
Science College, Nagpur.



DHARAMPETH M. P. DEO MEMORIAL SCIENCE COLLEGE, NAGPUR
INTERNAL QUALITY ASSURANCE CELL (IQAC)

Activity Report

Date: 30/12/22

Name of Organizing Department or Committee: Zoology

Name of the activity: Visit to Fish Expo at College of Fisheries Nagpur

Suggested CRITERION point if any: Criteria II

Date of Activity: 3/12/2022

Place of Activity: College Of Fisheries Nagpur

Name of Guest Speaker judge/s or Chief Guest/s if any: NA

Title of the Activity: Visit to Fish Expo.

Number of Participants: 16

Name of the Teacher In-charge / Convener: Dr. K. M. Paturkar

Names of other Committee Members / Staff: Dr. K. M. Paturkar

OUTCOME of the Activity with respect to mission vision of the institute and or academics:

Students get information and live demonstration on fish breeding process with hatcheries

Students viewed various edible freshwater fishes and aquarium fishes

Students can operate and maintain fish aquarium

Students also get knowledge on fish food available in market

Water testing kit display explains procedure and its importance

Activity with newspaper coverage if any: NIL

Activity data save in PC of: Zoology Department/personal laptop



Prof. Pitambar Humane
IQAC Coordinator

COORDINATOR
 INTERNAL QUALITY ASSURANCE CELL
 DHARAMPETH, M. P. DEO MEMORIAL &
 SCIENCE COLLEGE, NAGPUR

Dr. Kirti Paturkar
Name & Signature of Teacher In-charge

Dr. Akhilesh Peshwe
Principal

Principal
 Dharampeth M. P. Deo Memorial
 Science College, NAGPUR



DHARAMPETH M. P. DEO MEMORIAL SCIENCE COLLEGE,
North Ambazari Road, Near Ambazari Lake, Nagpur- 440033

DATA VALIDATION & VERIFICATION (DVV)

Name of the Programme : Visit to Fish Expo at College of Fisheries Science, Nagpur
Date of the Programme : 3/12/22
Name of Chief Guest if any : _____
Name of Guest Speaker if any : _____

Sr. No.	Name of the Participant	Mobile Number	E-mail Id	Signature
1.	Siddhant Mishra	9579092931	hishantmishra1234@gmail.com	
2.	Vishal D. Mishra	9730747159	mishratara28@gmail.com	
3.	Shruti M. Pawar	9527988707	shruti.pawar001@gmail.com	
4.	Ishika S. Thakre	8010207069	ishithakre22@gmail.com	
5.	Aarshi M. Gaule	7758058514	aarshigaule2908@gmail.com	
6.	Tisha Kadam	9021541048	shatakadam@gmail.com	
7.	Jyoti J. Sharma	888669196380	jyotis3390@gmail.com	
8.	Bhargavi A. Lambare	7709403806	bhargavisambar05@gmail.com	
9.	Nandini S. Hodge	9370301679	nandinihodge17@gmail.com	
10.	Tanmay S. Chaudhari	8600102341	tchoudhari8600@gmail.com	
11.	Manish Gade	9370329857	manishgade79@gmail.com	
12.	Sanket Lode	7972085380	Sanketlode123@gmail.com	
13.	Sarvag Yadav	87667435158	SarvagShrivastava20@gmail.com	
14.	Vaishnavi Lakhe	8669594805	phabuli.lakhe53@gmail.com	

Signature of:
Programme In-charge

IQAC Coordinator
IQAC Co-ordinator
Dharampeth M.P. Deo Memorial
Science College, Nagpur-440033

Principal
Principal
Dharampeth M.P. Deo Memorial
Science College, Nagpur.



DHARAMPETH M. P. DEO MEMORIAL SCIENCE COLLEGE,
North Ambazari Road, Near Ambazari Lake, Nagpur- 440033

DATA VALIDATION & VERIFICATION (DVV)

Sr. No.	Name of the Participant	Mobile Number	E-mail Id	Signature
15.	Praywal Mungle	9834284907	praywalmungle123@gmail.com	
16.	Tinu Rahanyclute	9821776769	Hnrsuhanyclute@ymv	
17.				
18.				
19.				
20.				
21.				
22.				
23.				
24.				
25.				
26.				
27.				
28.				
29.				
30.				
31.				
32.				
33.				
34.				

Signature of:

Programme In-Charge

IQAC Coordinator

IQAC Co-ordinator

Dharampeth M.P. Deo Memorial
Science College, Nagpur-440033

Principal

Principal

Dharampeth M.P. Deo Memorial
Science College, Nagpur.



DHARAMPETH M. P. DEO MEMORIAL SCIENCE COLLEGE, NAGPUR
INTERNAL QUALITY ASSURANCE CELL (IQAC)

Activity Report

Date: 3-12-2022

Name of Organizing Department or Committee: Value Addition Committee

Name of the activity: Acknowledging the Staffs

Suggested CRITERION point if any: 1 & 5

Date of Activity: 3rd December 2022

Place of Activity: College Campus Ground

Name of Guest Speaker/s or Judge/s or Chief Guest/s if any:

Title of the Activity: International Disabled day

Number of Participants: 26

Name of the Teacher In-charge / Convener: Prof. Varsha Rangari

Names of other Committee Members / Staff: Mrs. Sujata Ali, Dr. R Pashine, Mrs. A. Shiledar, Mrs. Dipti Iyer, Mrs. Priyanka Joshi, Mrs. S. Jawade, Mrs. A. Gadewar, Mrs. M. Zhalke, Mrs. K. Kodape, Mr. H. Kolhe, Dr. R. Kalode.

OUTCOME of the Activity with respect to mission vision of the institute and or academics:

The Value Addition Committee of the college celebrated the International Disabled Day by acknowledging the work of college disabled staff Shri Patle, Mrs. Mona and Shri. Pohekar. Dr. Akhilesh Peshwe, Principal of College and Shri. Deo, Management member welcome them by giving saplings. They expressed their views on this occasion. Prof. Varsha Rangari, Incharge of Value Addition Committee gave the introductory remark. It was organized on college campus ground. Staff members and students were present on this occasion.

Activity with newspaper coverage if any: No

Activity data save in PC of: Prof V. V. Rangari

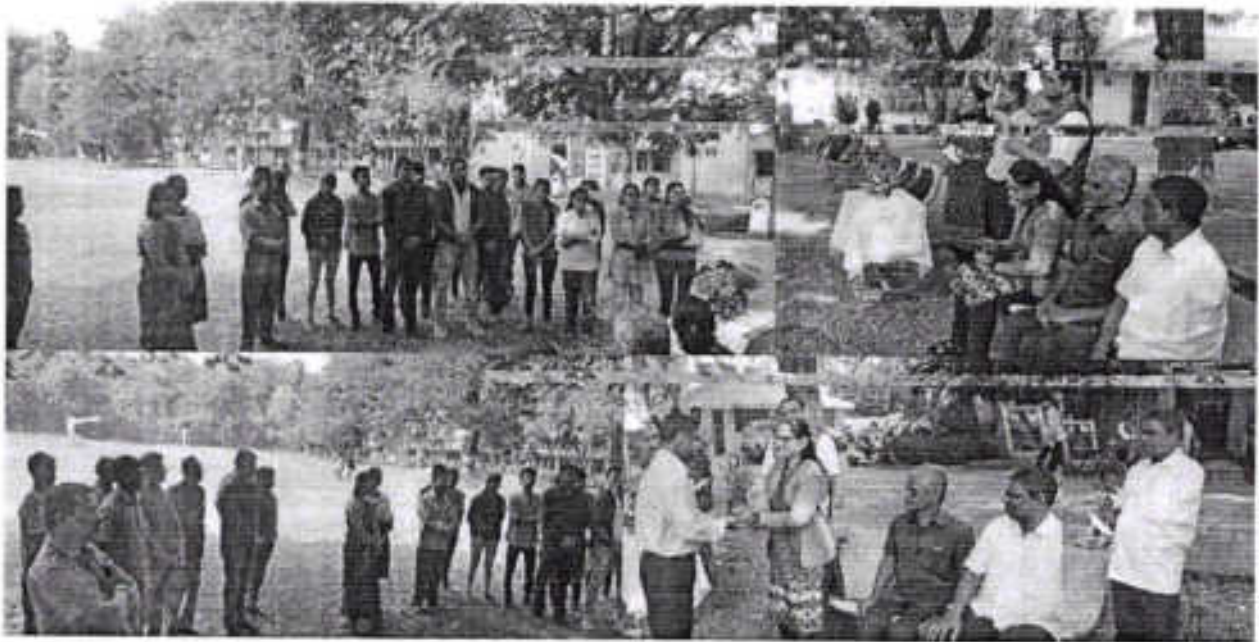

Note: Kindly share geotag photographs separately along with report on igacdsc2022@gmail.com

Prof. Pitambar Humane
IQAC Coordinator
CO ORDINATOR
INTERNAL QUALITY ASSURANCE CELL
DHARAMPETH, M. P. DEO MEMORIAL &
SCIENCE COLLEGE, NAGPUR

Name & Signature of Teacher In-charge

Dr. Akhilesh Peshwe
Principal

Principal
Dharampeth M.P. Deo Memorial
Science College, NAGPUR



DHARAMPETH M. P. DEO MEMORIAL SCIENCE COLLEGE,
North Ambazari Road, Near Ambazari Lake, Nagpur- 440033

DATA VALIDATION & VERIFICATION (DVV)

Name of the Programme : International Day of persons with Disabilities.
Date of the Programme : 3rd December 2022
Name of Chief Guest if any : Felicitation of staff members.
Name of Guest Speaker if any : -

Sr. No.	Name of the Participant	Mobile Number	E-mail Id	Signature
1	Amit Kumar	8600679848		
2	Suresh Choudhary	9975214341		
3	SANDEEP DEKATE	7756914869		
4	Rohit B. Patil	9623570507		
5	Mrs. Prachi P. Vishnu	9970193606		
6	Mr. Pritam C. Mundeshwar	9370555074		
7	Dr. Sandip Bhirwad	9595034388		
8	Mr. Roshan Thakur	8953661335		
9	Dr. H. P. Garkhad	9423103580		
10	D. P. Dhore	9561015679		

Signature of:

Programme in charge

CO-ORDINATOR
INTERNAL QUALITY ASSURANCE CELL
DHARAMPETH, M. P. DEO MEMORIAL &
SCIENCE COLLEGE, NAGPUR

Principal
Dharampeth M.P. Deo Memorial
Science College, NAGPUR



DHARAMPETH M. P. DEO MEMORIAL SCIENCE COLLEGE,
North Ambazari Road, Near Ambazari Lake, Nagpur- 440033

DATA VALIDATION & VERIFICATION (DVV)

11	Gajanan N. Mahapatra	9860350473		<i>[Signature]</i>
12	Dilip P. Hodge	8975571927		<i>[Signature]</i>
13	N. N. Nikhare	9601911360		<i>[Signature]</i>
14	P. M. Ashtekar	9860078891		<i>[Signature]</i>
15	K. M. Wadik	7776079583		<i>[Signature]</i>
16	K. R. Banatkar	8626806313		<i>[Signature]</i>
17	N. B. Tamboli	9665301087		<i>[Signature]</i>
18	Ravin Jadhav	8156772214		<i>[Signature]</i>
19	Samir Ghumde	9359236715		<i>[Signature]</i>
20	Himanshu Lakhe	7448252469		<i>[Signature]</i>
21	Rishikesh Detha	8988199260		<i>[Signature]</i>
22	Pratul G. Chitambar	7620511383		<i>[Signature]</i>
23	Siddhant V. Pawar	9527283213		<i>[Signature]</i>
24	Jasraj P. Patil	9422488044		<i>[Signature]</i>
25	Vishal V. Girhate	9673681472		<i>[Signature]</i>
26	Sumeet Bhalekar	9021627757		<i>[Signature]</i>

Signature of:

[Signature]
Programme In-charge

[Signature]
CO ORDINATOR
INTERNAL QUALITY ASSURANCE CELL
DHARAMPETH, M. P. DEO MEMORIAL &
SCIENCE COLLEGE, NAGPUR

[Signature]
Principal
Dharampeth M. P. Deo Memorial
Science College, NAGPUR



DHARAMPETH M. P. DEO MEMORIAL SCIENCE COLLEGE, NAGPUR
INTERNAL QUALITY ASSURANCE CELL (IQAC)

Activity Report

Date: 25/12/2022

Name of Organizing Department or Committee: Computer Science

Name of the activity: Error Debugging Activity

Suggested CRITERION point if any: V

Date of Activity: 03/12/2022

Place of Activity: Room Number 03(College Premises)

Name of Guest Speaker/s or Judge/s or Chief Guest/s if any: NA

Title of the Activity: Error Debugging from the code to enhance writing skills in programming.

Number of Participants: 55

Name of the Teacher In-charge / Convener: Mrs. Ruma Kapre

Names of other Committee Members / Staff: NA

OUTCOME of the Activity with respect to mission vision of the institute and or academics:

The activity error debugging improves the programming writing of the students and also made them familiar with the all types of errors they received after compilation of the program. Through this activity student practiced to remove errors from the code which enhances the writing skills of the student to write a program in the given programming language. In the activity all students first write their given code which is full of errors on the online compiler and then they debug that code in the given time and uploaded output of the code on the departmental portal.

Activity with newspaper coverage if any: NA

Activity data save in PC of: Mrs. Ruma Kapre



Prof. Pitambar Humane
IQAC Coordinator

CO ORDINATOR
INTERNAL QUALITY ASSURANCE CELL
DHARAMPETH M. P. DEO MEMORIAL &
SCIENCE COLLEGE, NAGPUR

Mrs. Ruma Kapre
Name & Signature of Teacher In-charge

Dr. Akhilesh Peshwe
Principal
Dharampeth M.P. Deo Memorial
Science College, Nagpur.



DHARAMPETH M. P. DEO MEMORIAL SCIENCE COLLEGE,
North Ambazari Road, Near Ambazari Lake, Nagpur- 440033

DATA VALIDATION & VERIFICATION (DVV)

Name of the Programme : Error Debugging Activity [SEM I: UNIT III]
Date of the Programme : 03/12/2022
Name of Chief Guest if any : _____
Name of Guest Speaker if any : _____

Sr. No.	Name of the Participant	Mobile Number	E-mail Id	Signature
1	Pranali V. Gupta	7020069377	29991537@gmail.com	<u>Gupta</u>
2	Jagruti G. Fullkar	6707911307	JagrutiFullkar@gmail.com	<u>JK</u>
3	Divyani G. Zade	7972403069	divyanizade2005@gmail.com	<u>Zade</u>
4	Purachi K. Gajbhiye	9763765826	Purachigajbhiye1967@gmail.com	<u>Purachi</u>
5	Tanuja G. Yelure	9529449565	TanujaYelure228@gmail.com	<u>T.G. Yelure</u>
6	Preethya B. Tispude	8010362232	preethyatispude9125@gmail.com	<u>Preethya</u>
7	Vansha L. Turkar	9373650950	vanshaturkar488@gmail.com	<u>Turkar</u>
8	Ishita Deshpande	9130091540	ishitan.deshpande21004@gmail.com	<u>Ishita</u>
9	Veena Borikar	9322016921	veena.borikar14@gmail.com	<u>Veena</u>
10	Janhvi Joge	7385060871	JanhviJoge08@gmail.com	<u>Janhvi</u>

Signature of

Programme In-charge

Mrs. Ruma Kapre

[Signature]
IQAC Coordinator
CO ORDINATOR
INTERNAL QUALITY ASSURANCE CELL
DHARAMPETH, M. P. DEO MEMORIAL &
SCIENCE COLLEGE, NAGPUR

[Signature]
Principal
Dharampeth M.P. Deo Memorial
Science College, Nagpur.



DHARAMPETH M. P. DEO MEMORIAL SCIENCE COLLEGE,
North Ambazari Road, Near Ambazari Lake, Nagpur- 440033

DATA VALIDATION & VERIFICATION (DVV)

11	Vaidhi Nagarkar	9325963446	vaidhi.nagarkar16@gmail.com	Vaidhi
12	Samiksha Shendre	7420881158	samikhastender@ashymail.com	Samiksha
13	Divyani Zagade	9022866318	divyani.zagade@gmail.com	Divyani
14	Sonita Niwal	4058928021	sonitaniwal48@gmail.com	Sonita
15	Vidya Lohi	7020963219	vidyalohi8@gmail.com	Vidya
16	Devashikha Kulkarni	9021344265	kakoldevashika@gmail.com	Devashikha
17	Samiksha A. Panchbudhe	9763075890	samikhapanchbudhe@gmail.com	Samiksha
18	Tejas Dongre	9322578918	Tj.9874k@gmail.com	Tejas
19	Abhishek R. Singh	8208948107	Abhi0882005@gmail.com	Abhishek
20	Vedant B. Umethkar	9049932753	umethkar.vedant@gmail.com	Vedant
21	Tushar R. Achare	9075995617	achare.tushar@gmail.com	Tushar
22	Uday C. Baghele	8459549609	baghele.oday@gmail.com	Uday
23	Ved. S. Chavdhary	7498572766	vedchavdhary.cs.74@gmail.com	Ved
24	Aashvi V. Singh	7498985604	aashvisingh5676@gmail.com	Aashvi
25	Khushi Pali	8459585914	pali.khushi@gmail.com	Khushi
26	Khushi Pali	8761607224	Pali.khushi@gmail.com	Khushi

Signature of:

Programme In-charge

IOAC Coordinator
CO ORDINATOR
INTERNAL QUALITY ASSURANCE CELL
DHARAMPETH, M. P. DEO MEMORIAL &
SCIENCE COLLEGE, NAGPUR

Principal
Principal
Dharampeth M.P. Deo Memorial
Science College, Nagpur.



DHARAMPETH M. P. DEO MEMORIAL SCIENCE COLLEGE,
North Ambazari Road, Near Ambazari Lake, Nagpur- 440033

DATA VALIDATION & VERIFICATION (DVV)

①	Janhvi H. Laibey	8446510539	Jhanvilaibey@gmail.com	Janhvi
②	Sakshi T. Mishra	9529889315	Smishra.99683@gmail.com	Smishra
③	Rutika Yadav	8446085948	yadav.rutika934@gmail.com	Rutika
④	Mohit Khedekar	8055328357	mohit.khedekar@gmail.com	Khedekar
⑤	Priyanshu Singh	9527710380	Priyanshu.singh10012@gmail.com	Priyanshu
⑥	Vibhanshu Tainr	9561232204	Vibhanshutaing@gmail.com	Vibhanshu
⑦	Gendal -B. Machade	9112142728	nikhilmachade005@gmail.com	Gendal
⑧	Trushabh sahj	7385310571	trushabhkshaha2004@gmail.com	Trushabh
⑨	Mahesh .D. Pawde	9112875119	pawdemahesh97@gmail.com	Mahesh
⑩	Vincentom Singh	7558426349	singhvincent78524@gmail.com	Vincent
11)	Ahel D. Thakre	9881956597	thakredavisingh@gmail.com	Ahel
12)	Lucky K. Navghare	9359626522	navgharelucky@gmail.com	Lucky
13)	Muskan C. Veichya	9309773287	muskanveichya09@gmail.com	Muskan
14)	Beetika G. Beeleve	9579836818	BeetikaShabeeve99@gmail.com	Beetika
15)	Badal G. Somkuwar	7448247750	badalsomkuwar1@gmail.com	Badal
16)	Lantik mire	9604792402	lantikmire2004@gmail.com	Lantik

Signature of:

Programme In-charge

COA COORDINATOR

INTERNAL QUALITY ASSURANCE CELL
DHARAMPETH, M. P. DEO MEMORIAL &
SCIENCE COLLEGE, NAGPUR

Principal

Dharampeth M.P. Deo Memorial
Science College, Nagpur.



DHARAMPETH M. P. DEO MEMORIAL SCIENCE COLLEGE,
North Ambazari Road, Near Ambazari Lake, Nagpur- 440033

DATA VALIDATION & VERIFICATION (DVV)

17	Aman Sujit Kaur	9028837552	ksan7817@gmail.com	
18	Pratik Devdas Chelakh	9021640532	pratikchulakh007@gmail.com	Pratik Chelakh
19	Ritik Harish Hirwar	744066424	Ritik.Hirwar195@gmail.com	Hirwar
20	Manu Pal	7350450579	manupal@gmail.com	Manu Pal
21	Pratik Harish Hirwar	8524788243	Pratik.Hirwar163@gmail.com	Pratik
22	Kashish K. Bisen	7887886117	Kashishbisen05@gmail.com	K. Bisen
23	Bhagyashali D. Newase	7796434177	sakshi.newase.2017@gmail.com	B.D. Newase
24	Cherna S. Buxie	8010342968	buxiechernas@gmail.com	Chernas
25)	Isha Waghmare	8855919474	ishawaghmare9474@gmail.com	Isha
26)	Prachi Pardhi	7263935912	prachipardhi252@gmail.com	P. K.
27)	Aditi Togi	9579962108	aditi.joshi2002@gmail.com	Aditi
28)	Janvi Khode	7385068834	JanviKhode992@gmail.com	Janvi

Signature of:

Programme In-charge

IQAC Coordinator
CO ORDINATOR
INTERNAL QUALITY ASSURANCE CELL
DHARAMPETH, M. P. DEO MEMORIAL &
SCIENCE COLLEGE, NAGPUR

Principal
Principal
Dharampeth M.P. Deo Memorial
Science College, Nagpur.



DHARAMPETH M. P. DEO MEMORIAL SCIENCE COLLEGE, NAGPUR
DEPARTMENT OF COMPUTER SCIENCE
ACADEMIC SESSION: 2022-23

NOTICE

1st December 2022

All the students of **B.Sc.[SEM III]** are hereby informed that the Department of Computer Science, Dharampeth M.P.Deo Memorial Science College, Nagpur is going to organize a Poster Making /Presentation Competition Activity on the Topic base on Unit IV of **Paper I[Data Structures]** on **12th December 2022**. All the students must remain present and participate in this activity and submit their poster on or before **5th December 2022**.

Venue: Computer Science laboratory
Time: 11.30am

Dr.Snehal Narale

Head, Department of Computer Science

Department of Computer Science,
Dharampeth M. P. Deo Memorial
Science College, Nagpur

Dr.Akhilesh Peshwe

Principal
Principal

Dharampeth M.P. Deo Memorial
Science College, Nagpur.



DHARAMPETH M. P. DEO MEMORIAL SCIENCE COLLEGE, NAGPUR
INTERNAL QUALITY ASSURANCE CELL (IQAC)
NEP Activity Report

Date: 30th December 2022

Name of Organizing Department or Committee: Computer Science Department

Name of the activity: Poster making /Presentation Competition

Suggested CRITERION point if any: Criteria II, V

Date of Activity: 12/12/2022

Place of Activity: Computer Science laboratory

Name of Guest Speaker/s or Judge/s or Chief Guest/s if any: Nil

Title of the Activity: Poster Making /Presentation Activity on Unit IV [Paper I: Data Structures] for the students of SEM III

Number of Participants: 49

Name of the Teacher In-charge / Convener: Dr. Mrs.Snehal Narale

Names of other Committee Members / Staff: Nil

OUTCOME of the Activity with respect to mission vision of the institute and or academics:

The main objectives of this activity were to prepare the students for the competition on the topics from their syllabus and explore their ideas in the form of poster. It also helps the students:

- To allow and provide the platform to express themselves through their personal vision on the topic of their poster.
- To showcase their talent and creativity through the poster prepared by them.
- To create and enhance the team work capability.
- To able to learn and gain insight on the basic and core knowledge on the topic and to receive live feedback and encouragement from the others.

Activity with newspaper coverage if any: Nil

Activity data save in PC of: Dr. Mrs. Snehal Narale's Laptop

Prof. Pitambar Humane
IQAC Coordinator
CO ORDINATOR
INTERNAL QUALITY ASSURANCE CELL
DHARAMPETH, M. P. DEO MEMORIAL &
SCIENCE COLLEGE, NAGPUR

Dr. Mrs.Snehal Narale
Name & Signature of Teacher In-charge
Department of Computer Science
Dharampeth M. P. Deo Memorial
Science College, Nagpur

Dr. Akhilesh Peshwe
Principal
Principal
Dharampeth M.P. Deo Memorial
Science College, Nagpur.



DHARAMPETH M. P. DEO MEMORIAL SCIENCE COLLEGE,
North Ambazari Road, Near Ambazari Lake, Nagpur- 440033

DATA VALIDATION & VERIFICATION (DVV)

Name of the Programme : poster presentation comp [sem III]
Date of the Programme : 18/12/2022
Name of Chief Guest if any : _____
Name of Guest Speaker if any : _____

Sr. No.	Name of the Participant	Mobile Number	E-mail Id	Signature
1.	Nitin A' Kushwaha	9693429005	nitin.kushwaha2904@gmail.com	
2.	Adityakumar S. Shukla	9518994638	adityashukla0025@gmail.com	
3.	Anuj H Mishra	9103656208	anujmishra@gmail.com	
4.	Jay Anilbhai Patil	7385436956	jay.patil0326@gmail.com	
5.	Purushottam P. Pawar	7020698071	purushottam.pawar@gmail.com	
6.	Prayakta Pawar	9356905759	prayakta2406@gmail.com	
7.	Khushboo G. Walimik	8983700782	Khushboowalimik14@gmail.com	
8.	Isha S Nemade	7028494761	ishanemade72@gmail.com	
9.	Santosh Jichkan	8605410878	santoshjichkan@gmail.com	
10.	Atharav. Urate	92811641511	atharav.urate@gmail.com	

Signature of:
Programme in-charge
Head,
Department of Computer Science
Dharampeth M. P. Deo Memorial
Science College, Nagpur

IQAC Coordinator
CO ORDINATOR
INTERNAL QUALITY ASSURANCE CELL
DHARAMPETH M. P. DEO MEMORIAL &
SCIENCE COLLEGE, NAGPUR

Principal
Dharampeth M.P. Deo Memorial
Science College, Nagpur.



DHARAMPETH M. P. DEO MEMORIAL SCIENCE COLLEGE,
North Ambazari Road, Near Ambazari Lake, Nagpur - 440033

DATA VALIDATION & VERIFICATION (DVV)

11	Anjali V. Ranganekar	8830031253	anjaliranganekar42@gmail.com	Anjali
12	Bhagyashree E. Pardey	9175302601	bhagyashreepardey@gmail.com	Bhagyashree
13	Sumit V. Dabil	9222140388	sumitvdbil2005@gmail.com	Sumit
14	Satish S. Singh	7258767502	satishsinghphd@gmail.com	Satish
15	Harikrishna C. Keshava	9067047777	harikrishnac@rediffmail.com	Harikrishna
16	Omkar D. Derangan	9963524388	omkaromaji12@gmail.com	Omkar
17	Hitesh B. Kaware	7058427112	hiteshbkaware22@gmail.com	Hitesh
18	Akshay P. Khandare	7350956809	akshaykhandare22@gmail.com	Akshay
19	Ketan S. Bhojar	9657957276	ketanbhojar55@gmail.com	Ketan
20	Harshad Ajankar	9527732348	harshadajankar@gmail.com	Harshad
21	Rahul Kowade	9359525216	kowaderahul20@gmail.com	Rahul
22	Arishtha A. Bansod	7810841788	arishthaabansod@gmail.com	A.P. Bansod
23	Amran Charho	7210486153	amrancharho@gmail.com	Amran
24	Ayush Banikar	9519445092	ayushbanikar14@gmail.com	Ayush
25	Atharva Umale	9284445111	atharva.umale@gmail.com	Atharva
26	Renuka Lunde	7710851401	renukalunde22@gmail.com	Renuka

Signature of:

Rasale

Programme In-charge
Head,

Department of Computer Science
Dharampeth M. P. Deo Memorial
Science College, Nagpur

[Signature]

IQAC Coordinator

CO ORDINATOR
INTERNAL QUALITY ASSURANCE CELL
DHARAMPETH, M. P. DEO MEMORIAL &
SCIENCE COLLEGE, NAGPUR

[Signature]

Principal

Dharampeth M. P. Deo Memorial
Science College, Nagpur.



DHARAMPETH M. P. DEO MEMORIAL SCIENCE COLLEGE,
North Ambazari Road, Near Ambazari Lake, Nagpur- 440033

DATA VALIDATION & VERIFICATION (DVV)

27	Aditya Kumar Singh	7350543901	aditya.singh.288120@gmail.com	7350543 AOK-S
28	Ankur Khurpadi	7243884120	khurpadi.ankur@gmail.com	ankur
29	Pratham Sitkare	9022553288	pratham.sitkare@gmail.com	pratham
30	Sakshi V. Kanode	8806934839	sakshikanode326@gmail.com	Skanode
31	Kunal Digrase	8010276303	kunaldigrase777@gmail.com	Kunal Digrase
32	Devang Korica	788238500	laddudivong@gmail.com	Devang
33	Swamini Rajanbhai	9357781014	swaminirajanbhai@gmail.com	Swamini
34	Urvasi S. Umathe	8177799299	urvashi.umathe@gmail.com	Urvasi
35	Sachin M. Patil	7276017322	sachinpatil19@gmail.com	Sachin
36	Nutan P. Surjuse	8805570279	nutanurjuse2@gmail.com	Nutan
37	Aditi Lute	7820812303	aditilute19@gmail.com	Aditi
38	Bhagyashree Thakare	8766925275	thakarebhagyashree@gmail.com	Bhagyashree
39	Sanchita Patil	9219099074	sanchitapatil1909@gmail.com	Sanchita
40	Damini Katre	8203255685	damini.katre13@gmail.com	Damini
41	Pritesh Naikam	9495089428	priteshnaikam123@gmail.com	Pritesh
42	Shubh Bedwal	808040184	shubhbedwal25@gmail.com	Shubh

Signature of
[Signature]
Programme In-charge
Department of Computer Science
Dharampeth M. P. Deo Memorial
Science College, Nagpur

[Signature]
IQAC Coordinator
INTEGRAL QUALITY ASSURANCE CELL
DHARAMPETH M. P. DEO MEMORIAL
SCIENCE COLLEGE, NAGPUR

[Signature]
Principal
Dharampeth M. P. Deo Memorial
Science College, Nagpur.



DHARAMPETH M. P. DEO MEMORIAL SCIENCE COLLEGE,
North Ambazari Road, Near Ambazari Lake, Nagpur-440033

DATA VALIDATION & VERIFICATION (DVV)

43	Ritul Bisen	7028510340	ritulbisen@gmail.com	Ritul
44	VAISHNAVI TADHAV	9156916355	vaishnavi1234@gmail.com	vaishnavi
45	Khushi Waghade	9156520713	khushi@gmail.com	Khushi
46	Urnati Chopde	9022627617	urnatichopde@gmail.com	Chopde
47	Mansi Nandanwat	7709322027	mansinandanwat@gmail.com	Nandanwat
48	Vicky Singh	9834782931	vickyasingh11032001@gmail.com	Vicky
49	Suman Singh	9322018536		Suman

Signature of:

Programme In-Charge
Heac.

Department of Computer Science
Dharampeth M. P. Deo Memorial
Science College, Nagpur.

IQAC Coordinator
INTERNAL QUALITY ASSURANCE CELL
DHARAMPETH M. P. DEO MEMORIAL
SCIENCE COLLEGE, NAGPUR.

Principal
Dharampeth M. P. Deo Memorial
Science College, Nagpur.



DHARAMPETH M. P. DEO MEMORIAL SCIENCE COLLEGE, NAGPUR

INTERNAL QUALITY ASSURANCE CELL (IQAC)

Activity Report

Date:8/12/2022

Name of Organizing Department or Committee: Department of Mathematics

Name of the activity: NEP based find the real life applications of partial differential equations for B.Sc. Semester-III

Suggested CRITERION point if any: Criterion I.

Date of Activity: 6/12/2022

Place of Activity: Class room

Name of Guest Speaker/s or Judge/s or Chief Guest/s if any: NA

Title of the Activity: Find the real life applications of partial differential equations

Activity with newspaper coverage if any: No

Number of Participants: B.Sc. Semester-III Students (45)

Name of the Teacher In-charge / Convener: Dr. N. P. Gaikwad

Names of other Committee Members / Staff: N.A.

OUTCOME of the Activity with respect to academics:

This activity provided an opportunity to B.Sc. Semester-III students to the real life applications of partial differential equations. Partial Differential Equations are used to mathematically formulate, and thus aid the solution of, physical and other problems involving functions of several variables, such as the propagation of heat or sound, fluid flow, elasticity, electrostatics, electrodynamics, thermodynamics, etc.

This activity helped students to understand the real life applications of partial differential equations.

DVV: Enclosed.

Prof. Pitambar Humane

IQAC Coordinator

CO ORDINATOR
INTERNAL QUALITY ASSURANCE CELL
DHARAMPETH, M. P. DEO MEMORIAL &
SCIENCE COLLEGE, NAGPUR

(Dr. N. P. Gaikwad)
Name & Signature of Teacher In-charge

Dr. Akhilesh Peshwe

Principal

Principal
Dharampeth M.P. Deo Memorial
Science College, Nagpur.



DHARAMPETH M. P. DEO MEMORIAL SCIENCE COLLEGE,
North Ambazari Road, Near Ambazari Lake, Nagpur- 440033

DATA VALIDATION & VERIFICATION (DVV)

Name of the Programme : Find the real life applications of partial diff. eqⁿ
 Date of the Programme : 06/12/2022
 Name of Chief Guest if any : —
 Name of Guest Speaker if any : —

Sr. No.	Name of the Participant	Mobile Number	E-mail Id	Signature
1	Nikita I Kallo	9061324988	kallonikita54@gmail.com	
2	Shital R. Ketzekar	9373389723	shital2020kka@gmail.com	
3	Prachit R. Kotpalliwar	7498102097	prachitkotpalliwar@gmail.com	
4	Aasmin Khalik Sheikh	8668323588	945min5029@gmail.com	
5	Sejal R. Lakhaupal	9028851568	sejalakhaupal@gmail.com	
6	Kajal P. Nighot	9373250623	kajurnighot2000@gmail.com	
7	Devang. Kavira	7888238500	laddudhara@gmail.com	
8	Jasraj D. Paliwal	9370820325	jasrajpaliwal47@gmail.com	
9	Hitesh G. Kaware	7058427112	hiteshkaware73@gmail.com	
10	Ankur Khurpadi	7249824620	khurpadiankur@gmail.com	
11	Rushikesh B. Hambarde	9028225874	rushikeshambarde33@gmail.com	
12	Kemal S Dighe	8010276303	kemaldighe777@gmail.com	

Programme In-charge

IQAC Co-ordinator
Dharampeth M.P. Deo Memorial
Science College, Nagpur-440033

Principal
Dharampeth M.P. Deo Memorial
Science College, Nagpur.



DHARAMPETH M. P. DEO MEMORIAL SCIENCE COLLEGE,
North Ambazari Road, Near Ambazari Lake, Nagpur- 440033

DATA VALIDATION & VERIFICATION (DVV)

13	Ritik M. Varama	93567114234	ritikv289@gmail.com	R. Varama
14	Ritik N. Gajbhiye	7620826960	ritikgajbhiye05@gmail.com	Rit
15	Aditya Kumar Singh	7350543901	adityasingh288180@gmail.com	A. K. S.
16	Dinesh I. Partheti	9623389676	Parthetidinesh51@gmail.com	D.
17	Vicky A. Singh	9834782931	vickysingh11032001@gmail.com	Vicky
18	Yash R. Khedekar	7020929422	yashkhedekar5@gmail.com	Yash
19	Chetan V. Popche	9172484628	Chetanpopche21@gmail.com	Chetan
20	Rahul Kawade	9359525716	Kawaderahul42@gmail.com	Rahul
21	Isha Nemade	7028494761	ishanemade72@gmail.com	Isha
22	Harshal Ajankar	9527732348	Harshalajankar8@gmail.com	H.A.
23	Ketan Bhayare	9657957276	Ketanbhayare76@gmail.com	Ketan
24	Kajal Prasad	7410763138	prasadkajal2004@gmail.com	Kajal
25	Bhagyawati Pandey	9175302601	pandeybhagyawati@gmail.com	B. Pandey
26	Shweta Bedwal	8080440154	shwetabedwal2605@gmail.com	Shweta
27	Rishi Kisen	7028910540	rishikisen06@gmail.com	Rishi
28	Mansi Nandanwar	7709322027	mansinandanwar@gmail.com	Mansi
29	Sarthak Jichkar	860750858	sarthajichkar@gmail.com	Sarthak
30	Sumit Sakle	9322410388	Sumitsakle1236@gmail.com	Sumit
31	Jay A Patil	7385436086	Jay.Patil10326@gmail.com	Jay

Programme In-charge

IQAC Coordinator
IQAC Co-ordinator

Dharampeth M.P. Deo Memorial
Science College, Nagpur-440033

Principal

Dharampeth M.P. Deo Memorial
Science College, Nagpur.



DHARAMPETH M. P. DEO MEMORIAL SCIENCE COLLEGE,
North Ambazari Road, Near Ambazari Lake, Nagpur- 440033

DATA VALIDATION & VERIFICATION (DVV)

32	Kavita Mishra	9657199201		Rishu
33	Divya Hanote	860542290	divyahanote2406@gmail.com	Divya
34	Pradumna Singh	7666939940	pradumna.singh@pethuwa.edu	Pradumna
35	Adityakumar Singh Shukla	9310994635	adityashukla002@gmail.com	Aditya
36	Nrupat Sharma	9322042259	AlpuraSharma258@gmail.com	Nrupat
37	Nitin khuskawaha	9693429005	nitinkhuskawa07@gmail.com	Nitin
38	Renuka Lande	7719951401	renukalande20@gmail.com	Renuka
39	Uditi kute.	7820812303	udtikute19@gmail.com	Uditi
40	Sanchita Patti.	9218099044	sanchitapatti2003@gmail.com	Sanchita
41	Damini katre.	8208255685	daminikatre31@gmail.com	Damini
42	Ananya Motghare	7219218955	Ananyamotghare@gmail.com	Ananya
43)	Veishnavi Jadhav	9166916855	170806593@gmail.com	Veishnavi
44)	Gaurav Landge	7767854057	GauravLandge@gmail.com	Gaurav
45)	Akshay Khandaze	7350956109	AkshayKhandaze79@gmail.com	Akshay

Signature of:

Programme In-charge

IQAC Coordinator
Dharampeth M.P. Deo Memorial
Science College, Nagpur-440033

Principal
Dharampeth M.P. Deo Memorial
Science College, Nagpur.



DHARAMPETH M. P. DEO MEMORIAL SCIENCE COLLEGE, NAGPUR
INTERNAL QUALITY ASSURANCE CELL (IQAC)

Activity Report

Date: 31/12/2022

Name of Organizing Department or Committee: IQAC Initiative

Name of the activity: Guest Lecture

Suggested CRITERION point if any: V

Date of Activity: 09/12/2022

Place of Activity: Late Vinaykrao Phatak Hall

Name of Guest Speaker/s or Judge/s or Chief Guest/s if any: Mr. Rajesh Welekar, Director, PMI Pvt. Ltd.

Title of the Activity: Are you ready for Industrial Opportunities

Number of Participants: 40

Name of the Teacher In-charge / Convener: Mr. Roshan Thakre

Names of other Committee Members / Staff: NA

OUTCOME of the Activity with respect to mission vision of the institute and or academics:

In the lecture guest speaker enlightened the students about career opportunities in the field of simulation. He also explained how this field is based on the principle of "Practice makes man perfect" in his talk, he explained instead of the background of the students the interest and the practice playing pivotal role to get success. The students of B.Sc. and M.Sc. can also compete with the engineering students in job opportunities if they learned simulation, he said. Students were benefited by his lecture.

Activity with newspaper coverage if any: NA

Activity data save in PC of: Mrs. Ruma Kapre



Mr. Roshan Thakre
Name & Signature of Teacher In-charge

Prof. Pitambar Humane
IQAC Coordinator

Dr. Akhilesh Peshwe
Principal

COORDINATOR
INTERNAL QUALITY ASSURANCE CELL
DHARAMPETH, M. P. DEO MEMORIAL &
SCIENCE COLLEGE, NAGPUR

Principal
Dharampeth M. P. Deo Memorial
Science College, Nagpur



DHARAMPETH M. P. DEO MEMORIAL SCIENCE COLLEGE,
North Ambazari Road, Near Ambazari Lake, Nagpur- 440033

DATA VALIDATION & VERIFICATION (DVV)

Name of the Programme : Guest Lecture
Date of the Programme : 9/12/2022
Name of Chief Guest if any : Mr. Rajesh Walekar, Brig. Subhas Kulkarni, Mr. Gopal Sharma
Name of Guest Speaker if any : Mr. Rajesh Walekar

Sr. No.	Name of the Participant	Mobile Number	E-mail Id	Signature
1	Ruchika R. Jawale	8080795303	ruchikajawale22@gmail.com	
2	Sejal P. Budhabhale	9766045604	Sejalbudhabhale975@gmail.com	
3	Komal Nagarao Jewle	9607757131	komaljewle75@gmail.com	
4	Utkarsha Namdev Bunde	8180890144	utkarshabunde@gmail.com	
5	Usha Harichandwanjori	7030997984	ushaharichandwanjori28@gmail.com	
6	Chandni M. Rane	9370551679	chandni2018@gmail.com	
7	Aastha J. Bopche	9096851418	bopcheaastha2002@gmail.com	
8	Soni A. Rai	885799507	Soniaanraii@gmail.com	
9	Pratiksha S. Chaudhari	7501317699	pratikshaschaudhari@gmail.com	
10	Seemaa M. Lakde	7058728070	seemalakde073@gmail.com	

Signature of:

Programme In-charge

CO ORDINATOR
IQAC Coordinator
INTERNAL QUALITY ASSURANCE CELL
DHARAMPETH M. P. DEO MEMORIAL &
SCIENCE COLLEGE, NAGPUR

Principal
Dharampeth M.P. Deo Memorial
Science College, Nagpur.



DHARAMPETH M. P. DEO MEMORIAL SCIENCE COLLEGE,
North Ambazari Road, Near Ambazari Lake, Nagpur- 440033

DATA VALIDATION & VERIFICATION (DVV)

11.	Ankita Laxman Sonware	9579661554	ankita2sonware10@gmail.com	<u>Bonware</u>
12.	Kiran Ramesh Waghade	9325845366	kiranwaghade09@gmail.com	<u>Waghade</u>
13	Akhit Ashokrao Mokaddam	7038988117	akhit.mokaddam311@gmail.com	<u>A.Mokaddam</u>
14	Vienndea D. Rathod	9307716206	vienndea.d.rathod@gmail.com	<u>Rathod</u>
15	Dhruv A Borkele	9895452419	dhruv.a.borkele@gmail.com	<u>Borkele</u>
16)	Pallavi S. Deshmukh	7447584135	PallaviS.Deshmukh2018@gmail.com	<u>Deshmukh</u>
17)	Pallavi G Mishrahe	9073424083	PallaviG.Mishrahe@gmail.com	<u>Mishrahe</u>
18)	Priyanka C. Shukla	9067210683	bscpriyankashukla	<u>Shukla</u>
19)	Nisha P. Uchali	7709260838	nishau97@gmail.com	<u>Uchali</u>
20	Snaha S. Hajare	9637811341	snahabamewar@gmail.com	<u>Hajare</u>

Signature of:

Programme In-charge

CO-ORDINATOR

IQAC Coordinator

INTERNAL QUALITY ASSURANCE CELL
DHARAMPETH, M. P. DEO MEMORIAL &
SCIENCE COLLEGE, NAGPUR

Principal

Dharampeth M.P. Deo Memorial
Science College, Nagpur



DHARAMPETH M. P. DEO MEMORIAL SCIENCE COLLEGE, NAGPUR
INTERNAL QUALITY ASSURANCE CELL (IQAC)

Activity Report

Date: 25th Dec., 2022

Name of Organizing Department or committee: BOTANY DEPARTMENT

Name of the activity: WORD PUZZLES

Suggested CRITERION point if any: Criterion-I

Date of Activity: 10th Dec., 2022

Place of Activity: DEPARTMENT OF BOTANY

Name of Guest Speaker/s or Judge/s of Chief Guest/s if any: Prof. Pitambar Humane, Dr. Mrs. Sweta Rai

Title of the activity: To prepare word puzzles on Plant Anatomy

Number of Participants: 25

Name of the Teacher In-charge/Convener: Dr. Chandrakumar Patle

Name of the other committee members / Staff: Dr. Mrs. Reshma Hiwase, Dr. Mrs. Sweta Roy, Mr. Amol Pimpalshende

OUTCOME of the Activity with respect to mission vision of the institute and or academics:
Word Puzzles help to develop the skills throughout the student's life. Puzzle really gives students a sense of achievement and pride within themselves. Word Puzzle provides a boost to their self confidence and self esteem with knowledge of that subject.

Activity with newspaper converge if any: N A

Activity data save in PC of: BOTANY

Prof. Pitambar Humane
IQAC Coordinator

CO ORDINATOR
INTERNAL QUALITY ASSURANCE CELL
DHARAMPETH, M. P. DEO MEMORIAL &
SCIENCE COLLEGE, NAGPUR

D. C. K. Patle

Name & Signature of Teacher In-charge

Dr. Akhilesh Peshwe
Principal
Principal
Dharampeth M.P. Deo Memorial
Science College, Nagpur.



DHARAMPETH M. P. DEO MEMORIAL SCIENCE COLLEGE,
North Ambazari Road, Near Ambazari Lake, Nagpur- 440033

DATA VALIDATION & VERIFICATION (DVV)

Name of the Programme : To prepare word word puzzles on Plant Anatomy
Date of the Programme : 10/12/2022
Name of Chief Guest if any : _____
Name of Guest Speaker if any : _____

Sr. No.	Name of the Participant	Mobile Number	E-mail Id	Signature
1)	Nikita Shyam Bawane	7058625053	rvachibawane@gmail.com	
2)	Nagaroo Hulke	8624091652	hulkaritesh@gmail.com	
3)	Asmita D. Chougale	7387005732	asmitachougale@gmail.com	
4)	chetna D. Bhopre	9021058104	Bhoprechetna@gmail.com	
5)	Muskan R. Yadav	9579492617	muskan.yadav1225	
6)	Devkishan D. Bisen	7767861231	DevkishanBisen20	
7)	Ashlesha Sangale	9503998469	Ashleshasangale99@gmail.com	
8)	Aditya. G. Dulkar.	4028915776	adulkaraditya20@gmail.com	
9)	Shreyas R. Deshmukh	8668282846	shreyas.deshmukh2422@gmail.com	
10)	Sagar S. Bawane	9975460979	sagarbawane637@gmail.com	

Signature of:

Programme In-charge

IQAC Coordinator
CO ORDINATOR
INTERNAL QUALITY ASSURANCE CELL
DHARAMPETH, M. P. DEO MEMORIAL &
SCIENCE COLLEGE, NAGPUR

Principal
Principal
Dharampeth M.P. Deo Memorial
Science College, Nagpur.





DHARAMPETH M. P. DEO MEMORIAL SCIENCE COLLEGE,
North Ambazari Road, Near Ambazari Lake, Nagpur- 440033

DATA VALIDATION & VERIFICATION (DVV)

11	Pratiksha Naughare	8623033760	Pratiksha55@gmail.com	T.S. Naughare
12	Chirayu B. Dolai	8010135012	chirayudolai22@gmail.com	B. Dolai
13)	Vaibhav A. Malewar	8967838219	Vaibhavmalewar74@gmail.com	V. Malewar
14)	AJUSH A. KADAM	99709763013263	ajk7515036@gmail.com	Ajush
15)	Devathi - Bisen	8693119078	DKBisen74@gmail.com	Devathi
16)	Jagruiti Rawat	9265818046	Jagruitiarawat52@gmail.com	J. Rawat
17)	Yukti Choudhary	7020953938	yukti.choudhary507@gmail.com	Yukti
18)	Subbu Mishra	9860436418	Subbumishra@gmail.com	Subbu
19)	Sakshi Jambhule	8329053523	Sakshijambhule@gmail.com	S. Jambhule
20)	Shikha J. Yadav	7263881320	Shikha.Yadav@gmail.com	S.J. Yadav
21)	Shruti P. Masram	8308657972	shrutimasram@gmail.com	Shruti
22)	Sakshi V. Pakhale	9371412192	Sakshipakhale323@gmail.com	Pakhale
23)	Vaishali Patle	9322600647	Vaishalipatle@gmail.com	Patle
24)	Sushma Gurnule	9156238247	sushmagurnule@gmail.com	Gurnule
25)	Varsha Tiwari	8408097738	varshatiwari@gmail.com	Varsha

Signature of:

Programme In-charge



IQAC Coordinator

CO ORDINATOR
INTERNAL QUALITY ASSURANCE CELL
DHARAMPETH, M. P. DEO MEMORIAL &
SCIENCE COLLEGE, NAGPUR.



Principal

Principal
Dharampeth M.P. Deo Memorial
Science College, Nagpur.



DHARAMPETH M. P. DEO MEMORIAL SCIENCE COLLEGE, NAGPUR
INTERNAL QUALITY ASSURANCE CELL (IQAC)

Activity Report

Date: 25th Dec., 2022

Name of Organizing Department or committee: BOTANY DEPARTMENT

Name of the activity: Anatomy of aerial root and climbing stem

Suggested CRITERION point if any: Criterion-I

Date of Activity: 12th Dec., 2022 & 13th Dec., 2022

Place of Activity: DEPARTMENT OF BOTANY

Name of Guest Speaker/s or Judge/s of Chief Guest/s if any: Prof. Pitambar Humane

Title of the activity: To study internal structure of aerial roots and climbing or twining stem

Number of Participants: 25

Name of the Teacher In-charge/Convener: Dr. Chandrakumar Patle

Name of the other committee members / Staff: Dr. Mrs. Reshma Hiwase, Dr. Mrs. Sweta Roy

OUTCOME of the Activity with respect to mission vision of the institute and or academics:
The study of plant anatomy helps to students to understand the structural adaptation as well as anomalous secondary growth with respect to environmental conditions. It also helps to understand and distinguish between structures of various habits of the plants.

Activity with newspaper converge if any: N A

Activity data save in PC of: BOTANY DEPARTMENT



Prof. Pitambar Humane
IQAC Coordinator

CO ORDINATOR
INTERNAL QUALITY ASSURANCE CELL
DHARAMPETH, M. P. DEO MEMORIAL &
SCIENCE COLLEGE, NAGPUR

Name & Signature of Teacher In-charge

Dr. Akhilesh Peshwe
Principal

Dharampeth M.P. Deo Memorial
Science College, Nagpur.

Chandrakumar Patle
Dr. C.K. Patle



DHARAMPETH M. P. DEO MEMORIAL SCIENCE COLLEGE,
North Ambazari Road, Near Ambazari Lake, Nagpur- 440033

DATA VALIDATION & VERIFICATION (DVV)

Name of the Programme : To study internal structure of aerial roots and climbing & twining stem

Date of the Programme : 12/12/2022 & 13/12/2022

Name of Chief Guest if any : _____

Name of Guest Speaker if any : _____

Sr. No.	Name of the Participant	Mobile Number	E-mail Id	Signature
1	Nikita shyam Baxapatwe	7058625053	naxibataxapatwe05@gmail.com	
2	chetna dipip Bhopure	9021058104	Bhopurechetna@gmail.com	
3	Aditya. Cugjann. Daultkar	9028415776	aditkannadhiya21@gmail.com	
4	Ashlesha V songode	9503998469	Ashleshasongode94@gmail.com	
5	Armita D. Chavhan	7387005732	Armitachavhan15@gmail.com	
6	Nagarao. D. Hulke	8624091652	hulkenilesh@gmail.com	
7	Devashish Bisen	7767861231	Devashishbisen91@gmail.com	
8	Muskar. R. Yadav	9579492617	muskanyadav1225@gmail.com	
9	Nikhil. R. Raut	9022680159	rauth0541@gmail.com	
10	Devashish D. Bisen	7773980643	Dk-bisen74@gmail.com	

Signature of:

Programme In-charge

IQAC Coordinator
CO ORDINATOR
INTERNAL QUALITY ASSURANCE CELL
DHARAMPETH, M. P. DEO MEMORIAL &
SCIENCE COLLEGE, NAGPUR

Principal
Principal
Dharampeth M.P. Deo Memorial
Science College, Nagpur.



DHARAMPETH M. P. DEO MEMORIAL SCIENCE COLLEGE,
North Ambazari Road, Near Ambazari Lake, Nagpur- 440033

DATA VALIDATION & VERIFICATION (DVV)

11	Abhishhek .D. Deshbhatar	8208302902	abhishkedeshbhatar2002@gmail.com	Abhishhek
12	Samir P. Ghumde	9359236713	sameerghumde2002@gmail.com	Ghumde
13	Nikita .S. Ghose	9860159628	nikitabhava.98@gmail.com	Nikita
14	Aanchal .S. Singh	7875537925	Santoshsingh22923@gmail.com	Aanchal Singh
15	Chirayu B. Doloi	8010135012	chirayudoloi22@gmail.com	Chirayu
16	Sudhanshu R. Uikay	7026029177	Sudhanshu2002@gmail.com	Sudhanshu
17)	Vaibhav A. Malewar	8767838219	vaibhavmalewar79@gmail.com	V. Malewar
18)	Shreyas R. Deshmukh	8668222846	Shreyasdeshmukh24@gmail.com	Shreyas
19)	Ankur A. Raut	9767873447	ankuraaut2003@gmail.com	Ankur
20)	Ketaki R. Karpal	9112759066	ketakikarpal13@gmail.com	Ketaki
21	Smrutti Vaidya	8856908764	SmruttiVaidya7@gmail.com	Smrutti
22	Anushree Chandel	9145631751	Anuchandel2001@gmail.com	Anushree
23	Afsina Sheikh	8080083981	afsinasheikh973@gmail.com	Afsina
24	Sweeti Longolge	8390516517	Sweetilongolge16@gmail.com	Sweeti
25	Vaishnavi Kapse	8983751089	vaishnavikapse05@gmail.com	Vaishnavi

Signature of:

Programme In-charge

IQAC Coordinator
CO ORDINATOR
INTERNAL QUALITY ASSURANCE CELL
DHARAMPETH, M. P. DEO MEMORIAL &
SCIENCE COLLEGE, NAGPUR

Principal
Principal
Dharampeth M.P. Deo Memorial
Science College, Nagpur.



DHARAMPETH M. P. DEO MEMORIAL SCIENCE COLLEGE, NAGPUR
INTERNAL QUALITY ASSURANCE CELL (IQAC)

Activity Report

Date: 25th Dec., 2022

Name of Organizing Department or committee: BOTANY DEPARTMENT

Name of the activity: Anatomy of leaves

Suggested CRITERION point if any: Criterion-1

Date of Activity: 12th Dec., 2022 & 13th Dec., 2022

Place of Activity: DEPARTMENT OF BOTANY

Name of Guest Speaker/s or Judge/s of Chief Guest/s if any: Prof. Pitambar Humane, Dr. Mrs. Sweta Rai

Title of the activity: To study anatomy of Leaves

Number of Participants: -39

Name of the Teacher In-charge/Convener: Dr. Chandrakumar Patle

Name of the other committee members / Staff: Dr. Mrs. Reshma Hiwase, Dr. Mrs. Sweta Roy

OUTCOME of the Activity with respect to mission vision of the institute and or academics: The study of anatomy of leaves help the students to understand the internal structure such as Epidermis, Kranz' Anatomy, position of stomata, and various types of tissues.

Activity with newspaper converge if any: N A

Activity data save in PC of: BOTANY DEPARTMENT

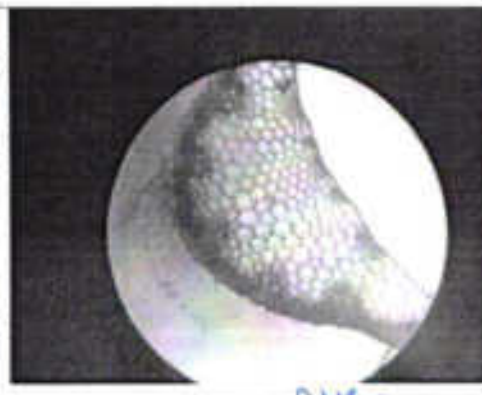

Prof. Pitambar Humane
IQAC Coordinator

CO ORDINATOR
INTERNAL QUALITY ASSURANCE CELL
DHARAMPETH, M. P. DEO MEMORIAL &
SCIENCE COLLEGE, NAGPUR

Chandrakumar Patle
Dr. Chandrakumar Patle
Name & Signature of Teacher In-charge

Dr. Akhilesh Peshwe
Principal

**Dharampeth M.P. Deo Memorial
Science College, Nagpur.**



DHARAMPETH M. P. DEO MEMORIAL SCIENCE COLLEGE,
North Ambazari Road, Near Ambazari Lake, Nagpur- 440033

DATA VALIDATION & VERIFICATION (DVV)

Name of the Programme : To study anatomy of leaves

Date of the Programme : 12/12/2022 & 13/12/2022

Name of Chief Guest if any : _____

Name of Guest Speaker if any : _____

Sr. No.	Name of the Participant	Mobile Number	E-mail Id	Signature
1.	Muskan A. Yadav	9579492617	muskanyadav1225	
2.	Devashish D Bisen	7767861231	DevashishBisen210	
3.	Devashish D Bisen	778980643	DKbisen	
4.	Nikita . S. Bhawe	9866159628	nikitabhawe98@gmail.com	
5.	Vaibhav A. Malewar	8767838219	Vaibhav A Malewar@gmail.com	
6.	Nikita . S. Banapatore	7058625053	Rachibavepatore@gmail.com	
7.	Chirayu B. Dolat	8010193012	Chirayudolat22@gmail.com	
8.	chetna . D. Bhopale	9821058109	Boprecheta@gmail.com	
9.	Ashlesha . V. Sangale	9563998669	ashleshasangale44	
10.	Harey . A. Kaut	9767873447	ankureent2002@gmail.com	

Signature of:

Programme In-charge

IOAC Coordinator

CO ORDINATOR
INTERNAL QUALITY ASSURANCE CELL
DHARAMPETH, M. P. DEO MEMORIAL &
SCIENCE COLLEGE, NAGPUR

Principal
Principal

Dharampeth M.P. Deo Memorial
Science College, Nagpur.



DHARAMPETH M. P. DEO MEMORIAL SCIENCE COLLEGE,
North Ambazari Road, Near Ambazari Lake, Nagpur- 440033

DATA VALIDATION & VERIFICATION (DVV)

11)	Shreya R. Deshmukh	8668282826	shreyadeshmukh212@gmail.com	Shreya
12)	Asmita D. Chavhan	7387005732	asmitachavhan21@gmail.com	Asmita
13)	Sudhanshu R. Uikay	7025429177	sudhanshu112@gmail.com	Sudhanshu
14	Anchal S. Singh	7875537925	sankeshsingh2123@gmail.com	Anchal Singh
15)	Ketaki R. Karpal	9112759066	ketakikarpal15@gmail.com	Ketaki
16)	Anushree Chandel	9145631751	anuchandel200@gmail.com	Anushree
17)	Smriti Vaidya	8856908764	smritivaidya36@gmail.com	Smriti
18.	Ahina Sheikh	8080083981	ahinashikh973@gmail.com	Ahina
19.	Aditya Patil	9028915776	adityapatil20@gmail.com	Aditya
20)	Vaishnavi Kapse	8988757089	vaishnavikapse08@gmail.com	Vaishnavi
21	Susmita Ingole	8390516517	susmitaingole16@gmail.com	Susmita
22	Sagar Bawane	9975460979	sagarbawane137@gmail.com	Sagar
23	Pratiksha Naughare	8623033760	NaugharePratiksha96@gmail.com	Pratiksha
24.	Shital G. Barkar	7758055139	shitalbarkar122@gmail.com	Shital

Signature of

Programme In-charge

IQAC Coordinator
CO ORDINATOR
INTERNAL QUALITY ASSURANCE CELL
DHARAMPETH, M. P. DEO MEMORIAL &
SCIENCE COLLEGE, NAGPUR

Principal
Principal
Dharampeth M.P. Deo Memorial
Science College, Nagpur.



DHARAMPETH M. P. DEO MEMORIAL SCIENCE COLLEGE,
North Ambazari Road, Near Ambazari Lake, Nagpur- 440033

DATA VALIDATION & VERIFICATION (DVV)

25.	Pallavi Borkar	9373187246	PallaviBorkar19@gmail.com	
26	Kalyani C. Shahare	9307046378	Shaharekalyani S. @gmail.com	
27	Devesh Ingaolga	8590516517	DeveshIngaolga@gmail.com	
28.	Nagatara Hulke	8624091652	hulkenilash@gmail.com	
29	Nilkhil Raut	9022680159	NilkhilRaut@gmail.com	
30	Abhishek Deshbhate	8208302902	abhishekdeshbhate@gmail.com	
31.	Samir Ghumde	9359236713	SamirGhumde2002@gmail.com	
32	Jagdish Raut	9265818046	JagdishRaut53@gmail.com	
33	Shruti P. Masram	8308657972	Shrutimasram01@gmail.com	
34.	Yashashree P. Charde	9766008929	yashashreecharde@gmail.com	
35	Shikha Yadav	7263881320		
36	Sakshi Pakhale	8371412192		
37)	Sakshi Jambhule	8329053523		
38)	Riya Rajee Kulmathe	7420956528	riyukulmathe@gmail.com	
39)	Shreya. S. Bagde.	8669883639.	bagdeshreya.78@gmail.com	

Signature of

Programme In-charge

IQAC Coordinator

CO ORDINATOR

**INTERNAL QUALITY ASSURANCE CELL
DHARAMPETH, M. P. DEO MEMORIAL &
SCIENCE COLLEGE, NAGPUR**

Principal

Principal

**Dharampeth M.P. Deo Memorial
Science College, Nagpur.**



DHARAMPETH M. P. DEO MEMORIAL SCIENCE COLLEGE, NAGPUR
INTERNAL QUALITY ASSURANCE CELL (IQAC)

Activity Report

Date: 25th Dec., 2022

Name of Organizing Department or committee: BOTANY DEPARTMENT

Name of the activity: Bonsai Preparation

Suggested CRITERION point if any: Criterion-I

Date of Activity: 12th Dec., 2022 & 13th Dec., 2022

Place of Activity: DEPARTMENT OF BOTANY

Name of Guest Speaker/s or Judge/s of Chief Guest/s if any: Prof. Pitambar Humane

Title of the activity: To study Bonsai preparation of some common plants.

Number of Participants:-34

Name of the Teacher In-charge/Convener: Dr. Chandrakumar Patle

Name of the other committee members / Staff: Dr. Mrs. Reshma Hiwase, Dr. Mrs. Sweta Roy

OUTCOME of the Activity with respect to mission vision of the institute and or academics:

The bonsai preparation activity help to understand the student to know how to bonsai formed. Bonsai helps humans to relax mind and reducing the vibe of psychological stress. This activity is creates the skill and confidence among the students.

Activity with newspaper converge if any: N A

Activity data save in PC of: BOTANY DEPARTMENT

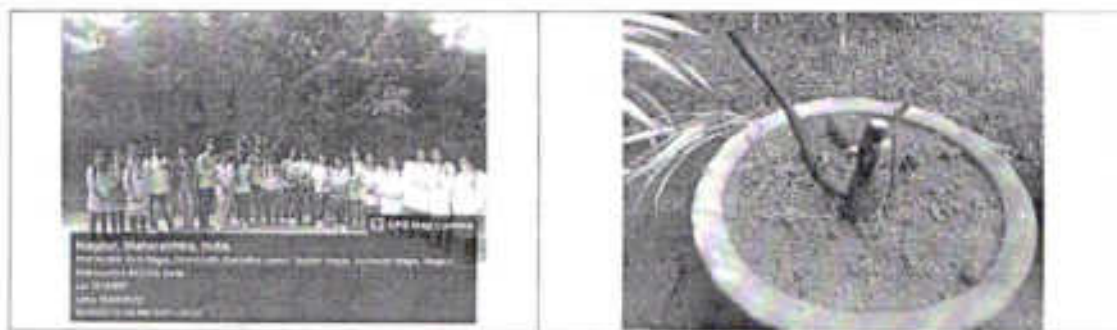

Prof. Pitambar Humane
IQAC Coordinator

CO ORDINATOR
INTERNAL QUALITY ASSURANCE CELL
DHARAMPETH, M. P. DEO MEMORIAL &
SCIENCE COLLEGE, NAGPUR

Chondrasomasa Patle
Dr. Chandrasomasa Patle
Name & Signature of Teacher In-charge

Dr. Akhilesh Peshwe
Principal

Dharampeth M.P. Deo Memorial
Science College, Nagpur.



DHARAMPETH M. P. DEO MEMORIAL SCIENCE COLLEGE,
North Ambazari Road, Near Ambazari Lake, Nagpur- 440033

DATA VALIDATION & VERIFICATION (DVV)

Name of the Programme : To study Borsai Preparation of some common plants.
Date of the Programme : 12/12/2022 & 13/12/2022
Name of Chief Guest if any : _____
Name of Guest Speaker if any : _____

Sr. No.	Name of the Participant	Mobile Number	E-mail Id	Signature
1]	Nikita shyam Baxapatkar	7058625053	nikitabaxapatkar050@gmail.com	
2]	Muskan R. Yadav	9579492617	muskan.yadav1221	
3]	Ayush A. Kadam	9763013763	ak2835036@gmail.com	
4]	Nilesh D. Hulke	8624091652	hulkenilesh@gmail.com	
5]	Nikhil R. Raut	9022680169	NikhilRaut@gmail.com	
6]	Ashlesha Sangode	9503998469	ashleshasangode99	
7]	Asmita D. Chhajjan	7382005722	asmitachhajjan@gmail.com	
8]	Aditya M. Dalkar	9028915776	adityadalkar@gmail.com	
9]	Devashish D. Bisen	7767861231	devashishbisen3@gmail.com	
10]	Chetna D. Bhopre	9021058104	chetna.d.bhopre@gmail.com	

Signature of:

Programme In-charge

IQAC Coordinator

CO ORDINATOR
INTERNAL QUALITY ASSURANCE CELL
DHARAMPETH, M. P. DEO MEMORIAL &
SCIENCE COLLEGE, NAGPUR

Principal

Dharampeth M.P. Deo Memorial
Science College, Nagpur.



DHARAMPETH M. P. DEO MEMORIAL SCIENCE COLLEGE,
North Ambazari Road, Near Ambazari Lake, Nagpur- 440033

DATA VALIDATION & VERIFICATION (DVV)

11	Abhishhek Deshbhete	8208302902	abhishhekdeshbhete@gmail.com	Abhishhek
12	Devashri Dnyaneshwar Bhanu	8692119078	DKBisen74@gmail.com	Bhanu
13	Sagar S. Bawane	9975460979	Sagarbawane637@gmail.com	ssbawane
14	Aanchal S. Singh	7875537325	SandoshSingh23923@gmail.com	Aanchal Singh
15	Chirayu B. Dalal	8010139012	chirayudalal@gmail.com	Chirayu
16	Pratiksha Naugare	8623033760	Pratikshy44@gmail.com	P.S. Naugare
17	Sudhanshu R. Vitek	7029479173	Sudhanshuvitek147@gmail.com	Vitek
18	Samir Ghumde	9359236723	sameerghumde2002@gmail.com	Ghumde
19)	Vaibhav A. Malewar	8767838219	vaibhavaalewar@gmail.com	V.A. Malewar
20)	Shreyas R. Deshmukh	8668282826	shreyasdeshmukh243@gmail.com	Shreyas
21)	Kalyani C. Shahare	9307046378	ShahareKalyani5@gmail.com	K.C. Shahare
22)	Shital G. Bankar	7758055139	shitalbankar122@gmail.com	SG Bankar
23)	Vaishnavi T. Kapse	8983751081	vaishnavi.kapse05@gmail.com	Vaishnavi
24)	Swati Longadge	8390516577	swati.longadge@gmail.com	Swati
25)	Nikita S. Thave	9860159628	nikitathave98@gmail.com	Nikita

Signature of:

Programme In-charge

Chandrakumar Bhu

[Signature]

IQAC Coordinator
CO ORDINATOR
INTERNAL QUALITY ASSURANCE CELL
DHARAMPETH, M. P. DEO MEMORIAL &
SCIENCE COLLEGE, NAGPUR

Principal

Principal

Dharampeth M.P. Deo Memorial
Science College, Nagpur.

[Signature]



DHARAMPETH M. P. DEO MEMORIAL SCIENCE COLLEGE,
North Ambazari Road, Near Ambazari Lake, Nagpur- 440033

DATA VALIDATION & VERIFICATION (DVV)

26	Jaykanti Rawat	9265818046	JaykantiRawat58@gmail.com	JRawat
27	Sakshi Pakhale	9371412192	Sakshipakhale32@gmail.com	Sakshale
28)	Shikha Yadav	7263881320	—	S.J.Yadav
29	Shruti P. Masram	8308657972	shrutimasram017@gmail.com	Shruti
30)	Yashashree P. Chondale	9769008975	yashashreechondale@gmail.com	Y.P.C.
31	Riya A. Kulkarni	7420956628	riyakulkarni11@gmail.com	Riya
32	Sakshi Sambhule	8329053523	—	Sambhule
33	Subbu Mishra	9860436418	subbumishra@gmail.com	Subbu
34.	Shreya Bagde	8669883639	bagdeshreya78@gmail.com	Sbagde

Signature of:

Programme In-charge



CO ORDINATOR
INTERNAL QUALITY ASSURANCE CELL
DHARAMPETH, M. P. DEO MEMORIAL &
SCIENCE COLLEGE, NAGPUR

Principal
Principal

Dharampeth M.P. Deo Memorial
Science College, Nagpur.



DHARAMPETH M. P. DEO MEMORIAL SCIENCE COLLEGE, NAGPUR

INTERNAL QUALITY ASSURANCE CELL (IQAC)

Activity Report

Date: 12th December 2022

Name of Organizing Department or Committee: Electronics Department

Name of the Activity : Finding the specifications of the available filters.

Suggested CRITERION point if any: Suggested criteria II

Date of Activity: 12th December 2022

Place of Activity : Electronics Lab

Name of Guest Speaker/s or Judge/s or Chief Guest/s if any : Not applicable

Title of the Activity: Finding the specifications of the available filters

Based on Unit : 4(Paper II)

Class : Semester III

Number of Participants: 16

Name of the Teacher In-charge/Convener: Mrs. Leena P. Thakare

OUTCOME of the Activity with respect to mission vision of the institute and or academics:

Students studied the specifications of digital filters. The designing parameters of filters were explained.

Prof. Vansha V. Kangari

Head of the Department

Prof. Pitambar Humane

IQAC Coordinator

IQAC Co-ordinator

Dharampeth M.P. Deo Memorial
Science College, Nagpur-440033

Dr. Akhilesh Peshwe

Principal

Principal

**Dharampeth M.P. Deo Memorial
Science College, Nagpur.**



DHARAMPETH M. P. DEO MEMORIAL SCIENCE COLLEGE, NAGPUR

Department of Electronics

Semester III- (2022-23)

ACTIVITY (PAPER II – UNIT 4)

Sr. No.	Student Name	Mobile No.	Email ID
1	Urvashi Sunilrao Umathe	9527708361	pragatichaure01@gmail.com
2	Jay Anilbhai Patil	7385436956	jay.patil0326@gmail.com
3	Janvi Ashok Kosarkar	8975756916	Janvikosarkar@gmail.com
4	Aasmin Abdulkhalik Sheikh	8788490684	abdulkhalik563698@gmail.com
5	Mansi Dilip Nandanwar	7709322027	mansinandanwar19@gmail.com
6	Renuka Vishal Lande	7719951401	renukalande220@gmail.com
7	Yash Ravindra Khedekar	7020829422	yashkhedekar5@gmail.com
8	Rahul Ramesh Kawade	9359525716	kawaderahul042@gmail.com
9	Chetan Umashankar Bopche	9172484628	chetanbopche27@gmail.com
10	Aditya Ravindra Singh	8999323047	aditya8999singh@gmail.com
11	Sandip Lotan Funde	9067118437	sandipfundesmc@gmail.com
12	Tushar Wadhawe		
13	Pawankumar Shivkumar Vishwakarma	7058408869	pawanvishwakarma67448@gmail.com
14	Unnatitai Chatrapal Chopde	9022627617	unnatichopde2002@gmail.com
15	Durgesh Krishna Singh	7385310432	ds608531@gmail.com
16	Bhagyarathi Ramvinay Pandey	9175302601	pandeybhagyarathi@gmail.com



Name & Signature of Teacher In-Charge

Prof. Pitambar Humane
IQAC Coordinator

CO ORDINATOR
INTERNAL QUALITY ASSURANCE CELL
DHARAMPETH, M. P. DEO MEMORIAL &
SCIENCE COLLEGE, NAGPUR

Name & Signature of Head of the
Department

Dr. Varsha V. P. Pandey
Professor & Head
Department of EI
Dharampeth M.P. Deo Memorial
Science College, Nagpur

Dr. Anillesh Peshwe
Principal

Principal
Dharampeth M.P. Deo Memorial
Science College, Nagpur.



DHARAMPETH M. P. DEO MEMORIAL SCIENCE COLLEGE, NAGPUR

INTERNAL QUALITY ASSURANCE CELL (IQAC)
Activity Report

Date: 14/12/2022

Name of Organizing Department or Committee: Department of Statistics

Name of the activity: Activity on Simplex Method (Numerical Example)

Suggested CRITERION point if any: Restricted to RTMNU BSc Statistics syllabus.

Date of Activity: 14/12/2022

Place of Activity: Statistics Lab

Name of Guest Speaker/s or Judge/s or Chief Guest/s if any: NA

Title of the Activity: Numerical example on simplex method

Activity with newspaper coverage if any: No

Number of Participants: 20

Name of the Teacher: Ms. Kumudini Kadbe

Names of other Committee Members / Staff: N.A.

OUTCOME of the Activity with respect to academics:

This activity provided an idea to students about simplex method of solving an LPP. Simplex method can be used to find out basic feasible solution. It aims at minimising the cost and maximising the profit of any production process.

DVV: Enclosed.

Activity data save in PC of: Lt. Dr. P. W. Ambekar

Prof. Pitambar Humane
IQAC Coordinator

CO ORDINATOR
INTERNAL QUALITY ASSURANCE CELL
DHARAMPETH, M. P. DEO MEMORIAL &
SCIENCE COLLEGE, NAGPUR

Name & Signature of Teacher In-charge

Dr. Akhilesh Peshwe
Principal

Principal
Dharampeth M.P. Deo Memorial
Science College, Nagpur.



DHARAMPETH M. P. DEO MEMORIAL SCIENCE COLLEGE NAGPUR

Department of Statistics

Class: B.Sc. Sem.-V

NEP ACTIVITY

Paper- I

Unit- IV

Name of the Teacher: Kumudini Kadbe

Date: 19/12/22

Title of Activity: Numerical example on simplex method

Sr. No.	Name of Student	Batch	Mobile No.	Email ID	Signature
1	Pfachi S. Manusmare	PSM (7)	9956969609	pfachi.manusmare@gmail.com	<u>Pfachi Manusmare</u>
2	Himanshu R. Lakhe	PSM	7468252469	himanshulakhe08@gmail.com	<u>lakhe</u>
3	Piyush G. Kapre	PSM	9373563077	kaprepiyush23@gmail.com	<u>Piyush</u>
4	Pratiksha S. Thakre	PSM	8459570299	Pratikshathakre1709@gmail.com	<u>Pratiksha</u>
5	Divyani U. Ekule	PSM	7030731921	divyanidhule2002@gmail.com	<u>D. U. Ekule</u>
6	Uday P. Khandarkar	PSM	9545897196	udaykhandarkar15@gmail.com	<u>Uday</u>
7	Sakshi L. Boraputre	PSM	8317219372	Sakshi2002bb@gmail.com	<u>Sakshi</u>
8	Vaibhav S. Rane	PSM	7744957383	Vaibhavrane2207@gmail.com	<u>Vaibhav</u>
9	Pratibha G. Gokhale	PSM	7620511383	Pratibhagokhale1999@gmail.com	<u>Pratibha</u>
10	Rishikesh R. Dethre	SCOM	9788199260	rishikeshdethre2002@gmail.com	<u>Rishikesh</u>
11	Sourabh Raut	SCOM	9527283213	Sourabhraut1995@gmail.com	<u>Sourabh</u>
12	Vidhi V. Girje	SCOM	9623671472	Vidhigirje22@gmail.com	<u>Vidhi</u>
13	Neha J. Bankar	SCOM	8055477553	nehaj2002bankar@gmail.com	<u>Neha Bankar</u>
14	Sahil R. Jivde	SCOM	9373414643	sahiljivde75@gmail.com	<u>Sahil</u>
15	Diya R. Patil	SCOM	1757052463	diyapatil1553@gmail.com	<u>Diya</u>
16	Tanu S. Mahule	SCOM	7057844982	tanumahule45@gmail.com	<u>Tanuhule</u>
17	Komal M. Kumbhar	SCOM	7620314869	kumbhary.komal94@gmail.com	<u>Komal</u>
18	Sumeet Bhalekar	SCOM	9021627357	sumitbhalekar262@gmail.com	<u>Sumeet</u>
19	Tejas P. Patil	SCOM	9422485045	Tejaspatil2002@gmail.com	<u>Tejas</u>
20	Brunjal D. Sawarkar	SCOM	7385455310	brunjal'sawar1234@gmail.com	<u>Brunjal</u>

Signature of Teacher

Teacher Incharge



DHARAMPETH M. P. DEO MEMORIAL SCIENCE COLLEGE, NAGPUR
INTERNAL QUALITY ASSURANCE CELL (IQAC)

Activity Report

Date: 15, DEC 2022

Name of Organizing Department or Committee: BOTANY DEPARTMENT

Name of the activity: To study different types of stomata in plants found in and around college campus.

Suggested CRITERION point if any: CRITERION-I

Date of Activity: 15, DEC., 2022

Place of Activity: DHARAMPETH M.P. DEO MEMORIAL SCIENCE COLLEGE

Name of Guest Speaker/s or Judge/s or Chief Guest/s if any: Dr. Mrs. Sweta Rai

Title of the Activity: To study different types of stomata in plants found in and around college campus

Number of Participants:15

Name of the Teacher In-charge / Convener: Prof. Pitambar Humane

Names of other Committee Members / Staff: Dr. Chandrakumar Patle, Mr. Amol Pimpalshende, Dr. Mrs. Reshma Hiwase, Dr. Mrs. Sweta Rai & Mrs. Dipali Nikure

Outcome of the Activity with respect to mission vision of the institute and or academics:

This study creates knowledge of different types of stomata present in different families plants and impart the knowledge about the specific different types of stomata varies in their structure eg: anisocytic, paracytic, dianocytic etc. This study has developed curiosity and keen interest among the students.

Activity with newspaper coverage if any: NA

Activity data save in PC of: Prof. Pitambar Humane's Laptop



Prof. Pitambar Humane
IQAC Coordinator

CO ORDINATOR
INTERNAL QUALITY ASSURANCE CELL
DHARAMPETH, M. P. DEO MEMORIAL &
SCIENCE COLLEGE, NAGPUR

Dr. Sweta A. Rai
Name & Signature of Teacher In-charge

Dr. Akhilesh Peshwe
Principal
Principal
Dharampeth M.P. Deo Memorial
Science College, Nagpur.



DHARAMPETH M. P. DEO MEMORIAL SCIENCE COLLEGE,
North Ambazari Road, Near Ambazari Lake, Nagpur- 440033

DATA VALIDATION & VERIFICATION (DVV)

Name of the Programme : To study different types of stomata in plants found in and around college campus.
Date of the Programme : 15. Dec 2022
Name of Chief Guest if any : _____
Name of Guest Speaker if any : _____

Sr. No.	Name of the Participant	Mobile Number	E-mail Id	Signature
1.	Neha. A. Waghade	7249895144	nehawaghade16022002@gmail.com	<u>N. Waghade</u>
2.	Sakshi. V. Chamate	7709204983	chamate.sakshi24@gmail.com	<u>Sakshi</u>
3.	Mrunali. R. Songare	9850163812	Songare.mrunali16@gmail.com	<u>M. Songare</u>
4.	Saniya. P. Naik	9370570457	saniyanaiK91@gmail.com	<u>S. Naik</u>
5.	Vanshika. C. Yede	7558244609	vanshikoyede1@gmail.com	<u>V. Yede</u>
6.	Sakshi Giri	9529660277	sakshigiris2002@gmail.com	<u>S. Giri</u>
7.	Vishakha Gawade	1620351270	vishakha2020@gmail.com	<u>V. Gawade</u>
8.	Neha R. Khawase	8766738340	nehar2002kk@gmail.com	<u>N. Khawase</u>
9.	Asha. S. Landge	9322231581	ashalandge2002@gmail.com	<u>A. S. Landge</u>
10.	Sonam M. Uprade	9890230462	uprade.sonam@gmail.com	<u>S. Uprade</u>

Signature of:

[Signature]

Programme In-charge

[Signature]
IQAC Coordinator **CO ORDINATOR**
INTERNAL QUALITY ASSURANCE CELL
DHARAMPETH, M. P. DEO MEMORIAL &
SCIENCE COLLEGE, NAGPUR

[Signature]
Principal
Principal
Dharampeth M.P. Deo Memorial
Science College, Nagpur.



DHARAMPETH M. P. DEO MEMORIAL SCIENCE COLLEGE,
North Ambazari Road, Near Ambazari Lake, Nagpur- 440033

DATA VALIDATION & VERIFICATION (DVV)

11	Sushila S. Puri	7507439390	sushilapuri224@gmail.com	
12	Brijwal Munglo	9834284907	prajwalmunglo12@gmail.com	
13.	Kaustubh Ramteke	7218187714	skamtekekaustubh2002@gmail.com	
14.	Shubham Khatavagade	9818788915	shubham.khatavagade2002@gmail.com	
15.	Vaishnavi R. Chaudhari	7249882964	vaishnavichaudhari@gmail.com	

Signature of:

Programme In-charge

IQAC COORDINATOR
INTERNAL QUALITY ASSURANCE CELL
DHARAMPETH, M. P. DEO MEMORIAL &
SCIENCE COLLEGE, NAGPUR

Principal
Dharampeth M.P. Deo Memorial
Science College, Nagpur.



DHARAMPETH M. P. DEO MEMORIAL SCIENCE COLLEGE, NAGPUR
INTERNAL QUALITY ASSURANCE CELL (IQAC)

Activity Report

Date: 25th, DEC 2022

Name of Organizing Department or Committee: BOTANY DEPARTMENT

Name of the activity: To study different types of plant movements found in and around college campus.

Suggested CRITERION point if any: CRITERION-1

Date of Activity: 15, DEC., 2022

Place of Activity: DHARAMPETH M.P. DEO MEMORIAL SCIENCE COLLEGE

Name of Guest Speaker/s or Judge/s or Chief Guest/s if any: Dr. Mrs. Sweta Rai

Title of the Activity: To study different types of plant movements found in and around college campus or residence

Number of Participants:15

Name of the Teacher In-charge / Convener: Prof. Pitambar Humane

Names of other Committee Members / Staff: Dr. Chandrakumar Patle, Mr. Amol Pimpalshende, Dr. Mrs. Reshma Hiwase, Dr. Mrs. Sweta Rai & Mrs. Dipali Nikure

OUTCOME of the Activity with respect to mission vision of the institute and or academics:

This study creates knowledge of different types of plant movements and their impact on curvature or plant axis and impart the knowledge about different types of movements varies in their structure eg: tropic and nastic movement etc. This study has developed curiosity and keen interest the students.

Activity with newspaper coverage if any: NA

Activity data save in PC of: Prof. Pitambar Humane's Laptop



Prof. Pitambar Humane **CO ORDINATOR**
IQAC Coordinator **INTERNAL QUALITY ASSURANCE CELL**
DHARAMPETH, M. P. DEO MEMORIAL &
SCIENCE COLLEGE, NAGPUR

Name & Signature of Teacher In-charge

Dr. Akhilesh Peshwe
Principal
Dharampeth M.P. Deo Memorial
Science College, Nagpur.



DHARAMPETH M. P. DEO MEMORIAL SCIENCE COLLEGE,
North Ambazari Road, Near Ambazari Lake, Nagpur- 440033

DATA VALIDATION & VERIFICATION (DVV)

Name of the Programme

: Study different types of Plant Movements found in and around college campus or Residence.

Date of the Programme

: 15/12/2022

Name of Chief Guest if any

: _____

Name of Guest Speaker if any

: _____

Sr. No.	Name of the Participant	Mobile Number	E-mail Id	Signature
1.	Vaishnavi R. Chandekar.	7249882964	vaishnavichandekar-000@gmail.com	<u>Chandekar</u>
2.	Kaustubh R. Ramteke	7218487714	kaustubh.ramteke.202@gmail.com	<u>KRamteke</u>
3.	Shubham P. Khobragade	9518788915	shubhamkhobragade200@gmail.com	<u>SKhobragade</u>
4.	Pravali Mungale	9824234902	PravaliMungale@gmail.com	<u>P. mungale</u>
5.	Sakshi .V. Chamate	7709209933	chamatesakshi24@gmail.com	<u>Sakshi</u>
6.	Neha .A. Waghade	7249895144	nehawaghade16082002@gmail.com	<u>NWaghade</u>
7.	Mrunali .R. Sonsare	9850163812	sonsaremrunali16@gmail.com	<u>MRonsare</u>
8.	Saniya .P. Naik	9370570457	Saniyanaik51@gmail.com	<u>SNaik</u>
9.	Varshika .C. Yede	7558244609	VarshikaYede1@gmail.com	<u>Yede</u>
10.	Sakshi Giri	9529660277	sakshigiri2002@gmail.com	<u>S.Giri</u>

Signature of:

Dubai

Programme In-charge

IQAC Coordinator

[Signature]

CO ORDINATOR
INTERNAL QUALITY ASSURANCE CELL
DHARAMPETH, M. P. DEO MEMORIAL &
SCIENCE COLLEGE, NAGPUR

Principal

[Signature]

Principal
Dharampeth M.P. Deo Memorial
Science College, Nagpur



DHARAMPETH M. P. DEO MEMORIAL SCIENCE COLLEGE, NAGPUR

INTERNAL QUALITY ASSURANCE CELL (IQAC)

Activity Report

Date: 17/12/2022

Name of Organizing Department or Committee: Department of Mathematics

Name of the activity: NEP based Preparing Complex Number Maze for B.Sc. Semester-I

Suggested CRITERION point if any: Criterion I.

Date of Activity: 15/12/2022

Place of Activity: Class room

Name of Guest Speaker/s or Judge/s or Chief Guest/s if any: NA

Title of the Activity: Preparing Complex Number Maze

Activity with newspaper coverage if any: No

Number of Participants: B.Sc. Semester-I Students (62)

Name of the Teacher In-charge / Convener: Dr. N. P. Gaikwad

Names of other Committee Members / Staff: N.A.

OUTCOME of the Activity with respect to academics:

This activity provided a unique opportunity to B.Sc. Semester-I students to learn how to identify Complex number using maze. In this activity, The mazes are designed to help reinforce simplifying complex number. Students must work the problems then determine if the solution is real or imaginary. This demonstration helped students to understand the concept of complex number.

DVV: Enclosed.

(Dr. N. P. Gaikwad)
Name & Signature of Teacher In-charge



Prof. Pitambar Humane

IQAC Coordinator

CO ORDINATOR
INTERNAL QUALITY ASSURANCE CELL
DHARAMPETH, M. P. DEO MEMORIAL &
SCIENCE COLLEGE, NAGPUR



Dr. Akhilesh Peshwe

Principal

Principal
Dharampeth M.P. Deo Memorial
Science College, Nagpur.



DHARAMPETH M. P. DEO MEMORIAL SCIENCE COLLEGE,
North Ambazari Road, Near Ambazari Lake, Nagpur- 440033

DATA VALIDATION & VERIFICATION (DVV)

Name of the Programme : NEP based preparing complex number maze for B.Sem-I

Date of the Programme : 15/12/2022

Name of Chief Guest if any : —

Name of Guest Speaker if any : —

Sr. No.	Name of the Participant	Mobile Number	E-mail Id	Signature
	Pratik Niranwar	8324786243	pratikniranwar@gmail.com	Pratik
	Pratik Niranwar	2498066424	pratikniranwar@gmail.com	Pratik
	Pratik Niranwar	8767607224	pratikniranwar@gmail.com	Pratik
	Mohit Khandekar	8055328357	mohitkhandekar@gmail.com	Mohit
	Ved. S. Choudhary	7498972766	vedchoudhary579@gmail.com	Ved
	Tushal Achare	9075775617	achare.tushal.s@gmail.com	Tushal
	Uday C. Baghele	8459545603	bagheleuday@gmail.com	Uday
	Mahesh D. Pawade	9112875119	pawademahesh77@gmail.com	Mahesh
	Aditya S. Gosavi	3158948313	adityagosavi71@gmail.com	Aditya
	Vibhanshu K. Taje	9561232204	vibhanshu.taje@gmail.com	Vibhanshu
	Prigyanth Singh	9527710380	prigyanthsinghji0012@gmail.com	Prigyanth

Programme In-charge

IQAC Coordinator

IQAC Co-ordinator
Dharampeth M.P. Deo Memorial
Science College, Nagpur-440033

Principal

Principal
Dharampeth M.P. Deo Memorial
Science College, Nagpur.



DHARAMPETH M. P. DEO MEMORIAL SCIENCE COLLEGE,
North Ambazari Road, Near Ambazari Lake, Nagpur- 440033

DATA VALIDATION & VERIFICATION (DVV)

Tannu V. Warthi	8322044903	tannuwarthi@gmail.com	Warthi
Harshata Kulkarni	8263977208	harshatakulkarni@gmail.com	Harshata
Sandeep Kumar	8081144940	Sandeepk27900@gmail.com	Sandeep
Pranali Gupta	7020069377	xgg91537@gmail.com	Gupta
Gendral Bhojraj Machade	9112142728	nikhilmachade2005@gmail.com	Machade
Pawan G. Thakre	8262963719	thakrepawan799@gmail.com	Thakre
Krushbu Pali	8459565914	pali.krushbu59@gmail.com	Pali
Yadnyak Bhage	8623062678	yadnyak0106@gmail.com	Bhage
Vedant A. Ursetkar	9049932753	ursetkarvedant@gmail.com	Ursetkar
Simran N. Dhimale	7666330683	simrandhimale80@gmail.com	Dhimale
TANU .H. SINGH	8806355808	tanusingh68492@gmail.com	Singh
Shruutika G. Pise	9322316336	shruutikapise67@gmail.com	Pise
Divyani G. Zade	7972403069	divyanizade2005@gmail.com	Zade
Ashwini R Chaudhary	9699792732	chaudharyashwini28@gmail.com	A.R. Chaudhary
Vaishali Mahesh Sahare	7992925403	Vaishalisahare251@gmail.com	Vaishali
Janhvi M Joge	7395060871	Janhvijogee@gmail.com	Janhvi
Tejas Dongul	9322578918	TejasDongul253@gmail.com	Dongul
Uena Babiker	9322016921	uena.babiker@gmail.com	Uena
Sanika Shenkar	7420881158	Sanikashenkar@gmail.com	Shenkar

Programme In-charge

QAC Coordinator

Principal

QAC Co-ordinator

Principal

Dharampeth M.P. Deo Memorial
Science College, Nagpur-440033

Dharampeth M.P. Deo Memorial
Science College, Nagpur.



DHARAMPETH M. P. DEO MEMORIAL SCIENCE COLLEGE,
North Ambazari Road, Near Ambazari Lake, Nagpur- 440033

DATA VALIDATION & VERIFICATION (DVV)

Kashish .K. Bisen	7887886117	Kashishbisen05@gmail.com	K. Bisen
Nisha, Shriram Kankar	9890996545	nishakankar233@gmail.com	Nisha
Sania Niwal	7058425021	niwalsania10@gmail.com	Niwal
Bhagyashali D. Newase	1796434177	sakshinewase@gmail.com	B. Newase
Vaidhee. B. Gangal	7507907278	gangal.vaidhee@gmail.com	V. Gangal
Pranali A. Dehankar	8767581278	pdhna@gmail.com	Pranali
Jsha I. Waghmare	8855910474	ishawaghmare9674@gmail.com	J. Waghmare
Aniket J Bawakar	9767219301	AniketBawakar@gmail.com	Aniket
Badal Gendal Somkuwar	7448247750	badalsomkuwar1@gmail.com	Badal
Nayan M. Wadhare	7841870947	nayanwadhare24@gmail.com	Nayan
Yogita .J. Karmore	8381045307	swara.karmore@gmail.com	Y. Karmore
Shreya G. Bhimte	9637762811	shreyabhimte81@gmail.com	Shreya
Khineshwari R. Pushptode	8624976072	khineshwaripushptode@gmail.com	Khineshwari
Ankit R. patel	9970905638	ankitpatel797275@gmail.com	Ankit
Vaidhvee B. Gangal	7507907278	gangal.vaidhvee@gmail.com	V. Gangal
Janhvi Kankare	7058235243	janhvikankare@gmail.com	Janhvi
Utkarsha Ingale	7499149178	utkarshaingale@gmail.com	Utkarsha

Signature of:

Programme In-charge

IQAC Coordinator
IQAC Co-ordinator

Dharampeth M.P. Deo Memorial
Science College, Nagpur-440033

Principal
Principal

Dharampeth M.P. Deo Memorial
Science College, Nagpur.



DHARAMPETH M. P. DEO MEMORIAL SCIENCE COLLEGE,
North Ambazari Road, Near Ambazari Lake, Nagpur- 440033

DATA VALIDATION & VERIFICATION (DVV)

Chetna S. Buniwle	8010342962	buniwlechetna@gmail.com	Chetna
Vaishali M. Sahasre	7972925403	VaishaliSahasre251@gmail.com	Vaishali
Tejas R Chelmekun	960466219	tejasr.chelmekun@gmail.com	Tejas
Devashree P. Kakate	9021344265	kakatedevashree@gmail.com	D.P. Kakate
Vaideli Nagarkar	9325968996	Vaidelinagarkar01@gmail.com	Vaideli
Sakshi Mishra	9529889315	Smishra99683@gmail.com	Sakshi
Varsha Turkar	9373650950	Varshaturkar48@gmail.com	Varsha
Dhnyani V. Zagade	9022866318	dhnyanizagade@gmail.com	Dhnyani
Janvi Khode	7385066634	JanviKhode192@gmail.com	Janvi
Samiksha Panchbudhe	9763075890	Samikshapanchbudhe363@gmail.com	Samiksha
Abhishek R. Singh	8208948107	Abhi0882005@gmail.com	Abhishek
Janhvi Laibey	8446510539	Janvilalibey@gmail.com	Janhvi
Rutika Yadav	8446085943	yadavarutika654@gmail.com	Rutika
Vivek Sah	9923763071	Vivek.sah7878@gmail.com	Vivek
Tanmay Tewari	9370144756	Tanmaytewari0763@gmail.com	Tanmay
Manu Patil	7350450579	manupatil@gmail.com	Manu

Signature of:

Programme In-charge

IQAC Coordinator
IQAC Co-ordinator

Dharampeth M.P. Deo Memorial
Science College, Nagpur-440033

Principal

Dharampeth M.P. Deo Memorial
Science College, Nagpur.



Activity Report

Date: 16, DEC 2022

Name of Organizing Department or Committee: BOTANY DEPARTMENT

Name of the activity: Collection and Identification of fungal members

Suggested CRITERION point if any: CRITERION-I

Date of Activity: 16th Dec., 2022

Place of Activity: DHARAMPETH M.P. DEO MEMORIAL SCIENCE COLLEGE

Name of Guest Speaker/s or Judge/s or Chief Guest/s if any: Prof. Pitambar Humane

Title of the Activity: To collect, identify and describe some common fungal members found in and around college campus or residence.

Number of Participants: 35

Name of the Teacher In-charge / Convener: Mr. Amol Pimpalshende

Names of other Committee Members / Staff: Dr. Chandrakumar Patle, Dr. Mrs. Sweta Rai & Mrs. Dipali Nikure

OUTCOME of the Activity with respect to mission vision of the institute and or academics: Field work was carried out for collection from various areas in and around college campus. Students understood the natural habitat of the flora of Fungus as well environmental condition in which they grown. Various types of Fungus members were observed by the students from College campus and they also gain information, how to collected and identify Fungus members. Some common Fugus members were collected and described by students with the help of Teachers and online sources. The *Auricularia auricula-judae* (edible Judas ear mushroom) also known as wood ear Mushroom, *Schizophyllum commune*, Peziza Fungus members were collected and identify by students. The interest and concentration of the students increases in the subject due to collection and identify the Fungus members in and around college campus.

Activity with newspaper coverage if any: NA

Activity data save in PC of: Mr Amol Pimpalshende's Laptop



Name & Signature of Teacher In-charge

Prof. Pitambar Humane
IQAC Coordinator

CO ORDINATOR
INTERNAL QUALITY ASSURANCE CELL,
DHARAMPETH, M. P. DEO MEMORIAL &
SCIENCE COLLEGE, NAGPUR

Dr. Akhilesh Peshwe
Principal
Dharampeth M.P. Deo Memorial
Science College, Nagpur



DHARAMPETH M. P. DEO MEMORIAL SCIENCE COLLEGE,
North Ambazari Road, Near Ambazari Lake, Nagpur- 440033

DATA VALIDATION & VERIFICATION (DVV)

Name of the Programme : To collect, identify and described some common fungal member found in and around college campus

Date of the Programme : 10.12.22

Name of Chief Guest if any : _____

Name of Guest Speaker if any : _____

Sr. No.	Name of the Participant	Mobile Number	E-mail Id	Signature
1.	Ravindra Khadse	2007198273	rkhadseavindras892@gmail.com	
2.	Lucky A Vishwakarma	9579660186	lvishwakarma240@gmail.com	
3.	Ichushi Bhaarti	9604567894	Ichushi bhaarti @	
4.	Arya Shoke	901681628	aryanamrata1331@gmail.com	
5.	Khushi Prasad	9637249032	khushiprasad (S)	
6.	Nikita das	8448297880	Nikitadas (S)	
7.	Aparna Mohane	7020649887	Aparnamohane23@gmail	
8.	Yagita R. Derge	7058437240	Yagitarang@gmail.com	
9.	Sefal D. Kolhe	8483045985	Kolhesefal@gmail.com	
10.	Anvay Borkar Peyanahu T. Raut	9168538864 9322725233	anvayborkar420@gmail.com Peyanahu Ekt -56 @ gmail	

Signature of:

Programme In-Charge

IQAC Coordinator

CO ORDINATOR
INTERNAL QUALITY ASSURANCE CELL
DHARAMPETH, M. P. DEO MEMORIAL &
SCIENCE COLLEGE, NAGPUR

Principal

Principal
Dharampeth M.P. Deo Memorial
Science College, Nagpur.



DHARAMPETH M. P. DEO MEMORIAL SCIENCE COLLEGE,
North Ambazari Road, Near Ambazari Lake, Nagpur- 440033

DATA VALIDATION & VERIFICATION (DVV)

11.	Aishul Y. Kinnapure	9284067169	anishulkinnapure0650@gmail.com	Aishul
12.	Anjali Thakre	7006559821	thakreanjv381@gmail.com	Anjali
13.	Prat Kamalika J. Chaudhari	9322033866	KamalikaChaudhari073@gmail.com	Kamalika
14.	Apeksha Kotangale	7559455799	Apekshakotangale@gmail.com	Apeksha
15.	Vaishnavi Tunge	8421057443	vaishnavitunge2006@gmail.com	Tunge
16.	Aasiya S. Hussain	7066411418	hussainasiya894	Ahussain
17.	Yachana K. Pandey	9156035297	pandeykns4@gmail.com	Pandey
18.	Kamalika J. Chaudhari	9322033866	KamalikaChaudhari073@gmail.com	Kamalika
19.	Pritya B. Sharma	8010764549	pritya1910004sharma@gmail	Pritya
20.	Priyanshu T. Raut	9322725233	Priyanshuraute56@g	Priyanshu
21.	Nisha Pandey	8605231390	nishishk8605231390@gmail.com	Nisha
22.	Anvay Barkar	9168538614	anvaybarkar@930@gmail	Anvay
23.	Ghanashree U. Dhokane	8459807047	ghanashreedhokane@gmail.com	Ghanashree
24.	Aarti K. Kharole	9579745628	aartikharole@gmail.com	Aarti
25.	Ashwini A. Lanjewar	9689117254	lanjewarashwini777@gmail.com	Ashwini
26.	Sunaina Chikhonde	8530970152	sunainachikhonde@gmail.com	Sunaina

Signature of:

Programme In-charge

IQAC Coordinator
COORDINATOR
INTERNAL QUALITY ASSURANCE CELL
DHARAMPETH, M. P. DEO MEMORIAL &
SCIENCE COLLEGE, NAGPUR

Principal
Principal
Dharampeth M.P. Deo Memorial
Science College, Nagpur.



DHARAMPETH M. P. DEO MEMORIAL SCIENCE COLLEGE,
North Ambazari Road, Near Ambazari Lake, Nagpur- 440033

DATA VALIDATION & VERIFICATION (DVV)

27.	Shreya Sanghashri Bagle	8669883639	bagdeshreya77@gmail.com	shagele.
28	Riya Raju Kulmethe	7420956528	riyakulmethe@gmail.com	Riya
28	Shikha Yadav			
29.	Yashashree P. Chavde	9766008929	yashashreechavde@gmail.com	Yash
30.	Vishakha D. Baswante	8329639834	vishakhabaswante@gmail.com	V Basw
30.	Valshnavi T. Kapse	8983751089	valshnavikapse01@gmail.com	valshnavi
32	Shital G. Bankar	9758055139	shitalbankar@gmail.com	S.G. Bankar
33	Kalyani C. Shahare	9307046378	shaharekalyanis@gmail.com	Kan
34.	Nikita S. Bhawe	9860159628	nikitabhawe@gmail.com	Nishave
35.	Aanchal S. Singh	7875537925	Sandosh Singh23923@gmail.com	Aanchal Singh

Signature of:

Programme In-charge

CO ORDINATOR
INTERNAL QUALITY ASSURANCE CELL
DHARAMPETH, M. P. DEO MEMORIAL &
SCIENCE COLLEGE, NAGPUR

Principal
Dharampeth M.P. Deo Memorial
Science College, Nagpur.



DHARAMPETH M. P. DEO MEMORIAL SCIENCE COLLEGE, NAGPUR
INTERNAL QUALITY ASSURANCE CELL (IQAC)

Activity Report

Date: 31/12/2022

Name of Organizing Department or Committee: IQAC Initiative

Name of the activity: Orientation Program

Suggested CRITERION point if any: VI

Date of Activity: 16/12/2022

Place of Activity: Late. Shri Vinayakrao Phatak Hall

Name of Guest Speaker/s or Judge/s or Chief Guest/s if any: Dr. Akhilesh Peshwe, Prof. Pitambar Humane, Lt. Dr. Prashant Ambaekar

Title of the Activity: Orientation Program on how to get registered on Digi locker Application and how to generate ABC ID of the students

Number of Participants: More than 140

Name of the Teacher In-charge / Convener: Mrs. Ruma Kapre

Names of other Committee Members / Staff: NA

OUTCOME of the Activity with respect to mission vision of the institute and or academics:

The training was given to the students for registration process to open DigiLocker account. Many students got registered themselves successfully on the DigiLocker during the programme. After completion of DigiLocker registration, students were also able to form their ABC ID. All the students also informed to import the various documents available with state and central government. Many of the students also responded to the google form after completion of the process of registration for DigiLocker and creation of ABC ID.

Activity with newspaper coverage if any: NA

Activity data save in PC of: Mrs. Ruma Kapre



Prof. Pitambar Humane

IQAC Coordinator

CO ORDINATOR

INTERNAL QUALITY ASSURANCE CELL
DHARAMPETH, M. P. DEO MEMORIAL &
SCIENCE COLLEGE, NAGPUR

Mrs. Ruma Kapre
Name & Signature of Teacher In-charge

Dr. Akhilesh Peshwe
Principal

Principal
Jharampeth M.P. Deo Memorial
Science College, Nagpur.



DHARAMPETH M. P. DEO MEMORIAL SCIENCE COLLEGE, NAGPUR
INTERNAL QUALITY ASSURANCE CELL (IQAC)

Activity DVV

Date: 31/12/2022

Name of Activity: Orientation Program

Date of Activity: 16/12/2022

Number of Participants: More than 140

Response Link:

https://docs.google.com/spreadsheets/d/1Kw5mLh0nhoj5t4dmrCttqy3Ltz4MaH381-jQths_g/edit?usp=sharing



Mrs. Ruma Kapre

Name & Signature of Teacher In-charge

Prof. Pitambar Humane
IQAC Coordinator

CO ORDINATOR
INTERNAL QUALITY ASSURANCE CELL
DHARAMPETH, M. P. DEO MEMORIAL &
SCIENCE COLLEGE, NAGPUR

Dr. Akhilesh Peshwe
Principal

Principal
Dharampeth M.P. Deo Memorial
Science College, Nagpur.



DHARAMPETH M. P. DEO MEMORIAL SCIENCE COLLEGE, NAGPUR
INTERNAL QUALITY ASSURANCE CELL (IQAC)

Activity Report

Date: 31.12.22

Name of Organizing Department or Committee: Department of Home-Science

Name of the activity: Lecture

Suggested CRITERION point if any:

Date of Activity: 17.12.22

Place of Activity: Department of Home Science

Name of Guest Speaker/s or Judge/s or Chief Guest/s if any: Dr. Shraddha. A
.Deshpande

Title of the Activity: Interdisciplinary Activity Lecture on the topic "Language in Adolescent Age" topic discussed by Teacher from Linguistic Department

Number of Participants: 14

Name of the Teacher In-charge / Convener: Mrs M.M. Deshpande

Names of other Committee Members / Staff: Faculty of Home Science Department

OUTCOME of the Activity with respect to mission vision of the institute and or academics:

Effective Learning Outcome

Value of making the Students learn to speak correct and affluent Language, improving language Skills.

Expression of Language ,Language Dialect, Qualitative & Language for fun & frolic and use of language.

Activity with newspaper coverage if any: Nil

Activity data save in PC of: Mrs. Manju Deshpande

Note: Kindly share geotag photographs separately along with report on iqacdsc2022@gmail.com



Prof. Pitambar Humane
IQAC COORDINATOR
INTERNAL QUALITY ASSURANCE CELL
DHARAMPETH, M. P. DEO MEMORIAL &
SCIENCE COLLEGE, NAGPUR

Name & Signature of Teacher In-charge

Dr. Akhilesh Peshwe

Principal
DHARAMPETH M. P. DEO MEMORIAL
SCIENCE COLLEGE, NAGPUR-440013



DATA VALIDATION & VERIFICATION (DVV)

Sr. NO	Name	Mobile NO.	E-mail	Sign
1.	Pragya S. Tiwari	6394098926	Pragyatiwari19052000@gmail.com	<u>Pragya</u>
2.	Ojaswi M. Wankhede	8767699751	wankhedaojaswi@gmail.com	<u>Ojaswi</u>
3.	Avani S. Shenwai	9096507459	Avanishenwai18@gmail.com	<u>Avani</u>
4.	Tannu S. Korde	7841984460	Kordetannu139@gmail.com	<u>Tannu</u>
5.	Priya K. Khawashi	9763617224	Priyakhawashi03@gmail.com	<u>Priya</u>
6.	Kimaya N. Kale	8866073792	Kimayakale003@gmail.com	<u>Kimaya</u>
7.	Pranali H. Athangadker	9309079427	Pranu02@gmail.com	<u>Pranali</u>
8.	Sujata V. Kawre	9175451202	sujatakawre1@gmail.com	<u>Sujata</u>
9.	Prajakta A. Wakde	8459413596	prajaktawakde49@gmail.com	<u>Prajakta</u>
10.	Kavina Diwe			
11.	Pallavi B. Katue	84592774008	Pkatue573@gmail.com	<u>Pallavi</u>
12.	Bhagyashree S. Ambule	9359130968	ambule662@gmail.com	<u>Bhagyashree</u>
13.	Poochi Laukhar			
14.	Shabnam T. Madawi	9022302785	shabnammadawi5@gmail.com	<u>Shabnam</u>

Signature of:

Programme In-charge

IQAC Coordinator

CO ORDINATOR

 INTERNAL QUALITY ASSURANCE CELL
 DHARAMPETH, M. P. DEO MEMORIAL &
 SCIENCE COLLEGE, NAGPUR

Principal

PRINCIPAL

 Dharampeth M.P. Deo Memorial
 Science College, Nagpur-440033



DHARAMPETH M. P. DEO MEMORIAL SCIENCE COLLEGE, NAGPUR

INTERNAL QUALITY ASSURANCE CELL (IQAC)

Activity Report

Date: 18/12/2022

Name of Organizing Department or Committee: Department of Mathematics

Name of the activity: NEP based short note on the work of Mathematician Carl Gustav Jacob Jacobi for B.Sc. Semester-I

Suggested CRITERION point if any: Criterion I.

Date of Activity: 17/12/2022

Place of Activity: Class room

Name of Guest Speaker/s or Judge/s or Chief Guest/s if any: NA

Title of the Activity: Short note on the work of Mathematician Carl Gustav Jacob Jacobi

Activity with newspaper coverage if any: No

Number of Participants: B.Sc. Semester-I Students (80)

Name of the Teacher In-charge / Convener: Dr. N. P. Gaikwad

Names of other Committee Members / Staff: N.A.

OUTCOME of the Activity with respect to academics:

Carl Gustav Jacob Jacobi was a German mathematician who made fundamental contributions to differential equations. This activity helped students to understand the concept of differential equations.

DVV: Enclosed.

C. D. N. P. Gaikwad
Name & Signature of Teacher In-charge



Prof. Pitambar Humane

IQAC Coordinator

CO ORDINATOR
INTERNAL QUALITY ASSURANCE CELL
DHARAMPETH, M. P. DEO MEMORIAL &
SCIENCE COLLEGE, NAGPUR



Dr. Akhilesh Peshwe

Principal

Principal
Dharampeth M.P. Deo Memorial
Science College, Nagpur.



DHARAMPETH M. P. DEO MEMORIAL SCIENCE COLLEGE,
North Ambazari Road, Near Ambazari Lake, Nagpur- 440033

DATA VALIDATION & VERIFICATION (DVV)

MEP based short note on the work of Mathematician
Name of the Programme : Carl Gustav Jacob Jacobi for B.Sc. Sem. 7
Date of the Programme : 17/12/2022
Name of Chief Guest if any : —
Name of Guest Speaker if any : —

Sr. No.	Name of the Participant	Mobile Number	E-mail Id	Signature
1]	Tushal Achare	9075995617	achare.tushal@gmail.com	Tushal
2]	Pranali Gupta	7020069377	20991537@gmail.com	Pranali
3]	Yadnyak S. Dhage	8623062678	ysdhage010@gmail.com	Y.S.D.
4)	Ritik H. Hiranwar	8324788243	Ritik.Hiranwar@gmail.com	Ritik
5)	Ritik H. Hiranwar	7498066424	Ritik.Hiranwar@pradica	Hiranwar
6	Gendral Bhograj Maelade	9112142728	nikhilmaelade2005@gmail.com	Gendral
	Prayanshu Singh	9527710380	prayanshusinghji0012@gmail.com	Pr Singh
	Uday C. Bayhale	8459549609	bayhaleuday@gmail.com	Uday
	Nahid Khindekar	8055328357	nahid.khindekar@gmail.com	Nahid
	Mahesh D. Pawde	9112875119	pawdemahesh93@gmail.com	Mahesh
	Moshi P. Puli	8767607224	Puli.Moshi19@gmail.com	Moshi
	Tanu S. Vauthi	9322044903	tanusvauthi@gmail.com	Tanu

Programme in-charge

QAC Coordinator

Dharampeth M. P. Deo Memorial
Science College, Nagpur-440033

Principal

Dharampeth M.P. Deo Memorial
Science College, Nagpur.



DHARAMPETH M. P. DEO MEMORIAL SCIENCE COLLEGE,
North Ambazari Road, Near Ambazari Lake, Nagpur- 440033

DATA VALIDATION & VERIFICATION (DVV)

Hareshata G. Wankhede	8263977208	hareshatawankhede@gmail.com	<u>Hareshata</u>
Aditya S. Gosavi	9158948913	aditya.gosavi71@gmail.com	<u>A. Gosavi</u>
Vibhanshu K. Taji	9561232204	Vibhanshutaji70@gmail.com	<u>Vibhanshu</u>
Krushby Pali	9459065914	pallkrushby@gmail.com	<u>Krushby</u>
Vedant S. Unsethkar	9049932753	unsethkar.vedant@gmail.com	<u>Vedant</u>
Sandeep Kumar	8001144948	sandeepk27900@gmail.com	<u>Sandeep</u>
Simran N. Dhimole	7666330683	simrandhimole80@gmail.com	<u>Dhimole</u>
TANU .H. SINGH	8806355808	tanusingh63492@gmail.com	<u>Tanu</u>
Pavani G. Thakre	8262969719	thakrepavani739@gmail.com	<u>P-Thakre</u>
Aniket J. Bawarkar	9467219301	AniketBawar50@gmail.com	<u>Aniket</u>
Abhinav Nigral	7058425021	nigralsonig70@gmail.com	<u>Abhinav</u>
Vaidhee. B. Gangadhar	7507907278	gangadhavaidhee@gmail.com	<u>Vaidhee</u>
Nisha Shrinam Kankar	989996645	nishakankar933@gmail.com	<u>Nisha</u>
Jeevi Kinnappa	7058235243	jeevikinnappa@gmail.com	<u>Jeevi</u>
Kashish. K. Bisen	9887886119	kashishbisen08@gmail.com	<u>K. Bisen</u>
Monali N. Shende	7796516257	shendemonali92@gmail.com	<u>Monali</u>
Pranali R. Dehankar	8167581278	pranali94@gmail.com	<u>Pranali</u>
Bhagvashali D. Newase	7796434177	sakshinewase2017@gmail.com	<u>B. Newase</u>
Chetna - S. Buxire	8010942968	buxire.chetna@gmail.com	<u>Chetna</u>

Programme In-charge

IQAC Coordinator

Principal

IQAC Co-ordinator

Principal

Dharampeth M.P. Deo Memorial
Science College, Nagpur-440033

Dharampeth M.P. Deo Memorial
Science College, Nagpur.



DHARAMPETH M. P. DEO MEMORIAL SCIENCE COLLEGE,
North Ambazari Road, Near Ambazari Lake, Nagpur- 440033

DATA VALIDATION & VERIFICATION (DVV)

Divyani G. zade	7972403069	divyanizade2005@gmail.com zade
Utkasha S. Ingale	7499152178	utkashalingale@gmail.com ingale
Shreutika G. Pise	9322316336	shreutikapise67@gmail.com Pise
Vaishali M. Sahasre	9972925903	VaishaliSahasre25@gmail.com Vaishali
Khineshwari R. Pushptade	8624976072	khineshwaripushptade@gmail.com sh
Shreya G. Bhimte	9637762811	shreyabhimte21@gmail.com shreya
Badal Gendal Somkuwar	7448247750	badalsomkuwar1@gmail.com Badal
Tejas Dongre	9322578918	Tejasdongre@gmail.com Tejas
Jankvi Joge	7395060871	JankviJoge08@gmail.com Jankvi
Veena Borikar	9322016921	veena borikar 14@gmail.com veena
Devashri P. Kakole	9021344265	kakoledevashri@gmail.com D.P.Kakole
Isha I. Waghmare	8855919474	ishawaghmare9474@gmail.com Isha
Tejas R Chelmelwar	9604662119	TejasChelmelwar@gmail.com Tejas
Yogita J. Karamare	8381045307	swara.karamare@gmail.com Yogita
Nayan N. Walthare	7941870947	NayanWalthare4@gmail.com Nayan
Ankit patel	9970905638	ankitpatel797275@gmail.com Ankit
Ashwini R Chaudhary	9699792732	chaudharyashwini@gmail.com A.R. Chaudhary

Signature of:

Programme In-charge

IQAC Coordinator
IQAC Co-ordinator

Dharampeth M.P. Deo Memorial
Science College, Nagpur-440033

Principal
Principal

Dharampeth M.P. Deo Memorial
Science College, Nagpur.



DHARAMPETH M. P. DEO MEMORIAL SCIENCE COLLEGE,
North Ambazari Road, Near Ambazari Lake, Nagpur- 440033

DATA VALIDATION & VERIFICATION (DVV)

Tanvi Laibey	8446510589	Tanvilalibey@gmail.com	Tanvi
Abhishek R. Singh	8208948107	Abhi0882005@gmail.com	Abhishek
Divyani V. Zagode	9022866318	divyani.zagode@gmail.com	Divyani
Jamini V. Khode	7355066634	Jamini.khode89@gmail.com	Jamini
Samiksha A. Panchbude	9763045290	sami.kshapanchbude35@gmail.com	S.Panchbude
Pratibha Bhusari	7821048413	pbusari718@gmail.com	PBB
Shivam Patel	703889083	Sp040263@gmail.com	Shivam
Saurabh Chaudhary	9395988301	Schaudhary559@gmail.com	Schi
Ritika Bhojar	9834587087	ritikabhoyar28@gmail.com	Ritika
Ruchi Dewadi	8080776893	ruchidewadi230@gmail.com	Ruchi
Durgesh Ghodmare	9075318618	durgeshghodmare0011@gmail.com	Durgesh
Shital Patel	9764596337	shitalpatel@gmail.com	Shital
Monika Patel	7499225468	monikapatel7038@gmail.com	Monika Patel
Varsha Turkar	9373650950	varsheturkar488@gmail.com	Varsha
Smishi Mishra	8529889315	Smishi8438683@gmail.com	Smishi
Rutika Yadav	8446085943	yadavrutika434@gmail.com	Rutika

Signature of:

Programme In-charge

IQAC Coordinator
IQAC Co-ordinator
Dharampeth M. P. Deo Memorial
Science College, Nagpur-440033

Principal

Principal
Dharampeth M.P. Deo Memorial
Science College, Nagpur.



DHARAMPETH M. P. DEO MEMORIAL SCIENCE COLLEGE,
North Ambazari Road, Near Ambazari Lake, Nagpur- 440033

DATA VALIDATION & VERIFICATION (DVV)

Divyani V-Zagade	9022866318	divyanizagade@gmail.com	Bzagade
Samitsheer. Panchbudhe	9763075890	SamiKshapanclb1406363@gmail.com	S. Panclbudhe
Jenui Khosle	7855066624	Jenuikhosle092@gmail.com	Other
Vaideli Nagalkar	9325963446	vaidelinagalkar07@gmail.com	Vaideli
Janvi Laibey	8446510539	Jnanvikubey@gmail.com	Jaibey
Utkasha D. Ingale	7499159178	utkashaingale9@gmail.com	Utkal
Janvi Kinapure	7058235243	janvikinapure@gmail.com	Kinapure
Pradnya Tirpude	8010362282	pradnyatirpude3145@gmail.com	Tirpude
Karishma Prasad	9309318667	narendraprasad72@gmail.com	Karishma
Monika J. Patil	7999225468	MonikaPatil7038@gmail.com	M. Patil
Varsha L. Turkar	9373650950	Varshaturkar7488@gmail.com	Turkar
Sakshi Mishra	9529889315	Smishra89683@gmail.com	Smishra
Shital. O. Patle.	9764596337	shitalpatle@gmail.com	Spalte
Abhishek R. Singl	8208948107	Abhi0882005@gmail.com	Singl
Rutika Yadav	8046085943	yadavrutika34@gmail.com	Yadav
Ruchi Wivedi	8080776893	Ruchiwivedi23@gmail.com	Ruchi

Signature of:

Programme In-charge

ICQAC Coordinator

Dharampeth M.P. Deo Memorial
Science College, Nagpur-440033

Principal

Dharampeth M.P. Deo Memorial
Science College, Nagpur



DHARAMPETH M. P. DEO MEMORIAL SCIENCE COLLEGE, NAGPUR

INTERNAL QUALITY ASSURANCE CELL (IQAC)

Activity Report

Date: 19th December 2022

Name of Organizing Department or Committee: Electronics Department

Name of the Activity : Designing astable multivibrator for 3 frequencies(10 Hz, 1KHz, 10KHz)

Suggested CRITERION point if any: Suggested criteria II

Date of Activity: 19th December 2022

Place of Activity : Electronics Lab

Name of Guest Speaker/s or Judge/s or Chief Guest/s if any : Not applicable

Title of the Activity: Designing astable multivibrator for 3 frequencies(10 Hz, 1KHz, 10KHz)

Based on Unit : 3(Paper II)

Class : Semester III

Number of Participants: 16

Name of the Teacher In-charge/Convener: Mrs. Leena P. Thakare

OUTCOME of the Activity with respect to mission vision of the institute and or academics:

Students calculated the values of R and C for given frequencies.

Prof. Varsha V. Rangari

Head of the Department



Prof. Pitambar Humane

IQAC Coordinator

IQAC Co-ordinator

Dharampeth M.P. Deo Memorial
Science College, Nagpur-440033

Dr. Akhilesh Peshwe

Principal

Principal

**Dharampeth M.P. Deo Memorial
Science College, Nagpur.**



DHARAMPETH M. P. DEO MEMORIAL SCIENCE COLLEGE, NAGPUR

Department of Electronics

Semester III- (2022-23)

ACTIVITY (PAPER II – UNIT 3)

Sr. No.	Student Name	Mobile No.	Email ID
1	Urvashi Sunilrao Umathe	9527708361	pragatichaure01@gmail.com
2	Jay Anilbhai Patil	7385436956	jay.patil0326@gmail.com
3	Janvi Ashok Kosarkar	8975756916	Janvikosarkar@gmail.com
4	Chetan Umashankar Bopche	9172484628	chetanbopche27@gmail.com
5	Yash Ravindra Khedekar	7020829422	yashkhedekar5@gmail.com
6	Rahul Ramesh Kawade	9359525716	kawaderahul042@gmail.com
7	Mansi Dilip Nandanwar	7709322027	mansinandanwar19@gmail.com
8	Renuka Vishal Lande	7719951401	renukalande220@gmail.com
9	Aasmin Abdulhalik Sheikh	8788490684	abdulhalik563698@gmail.com
10	Aditya Ravindra Singh	8999323047	aditya8999singh@gmail.com
11	Sandip Lotan Funde	9067118437	sandipfundesmc@gmail.com
12	Tushar Wadhawe		
13	Pawankumar Shivkumar Vishwakarma	7058408869	pawanvishwakarma67448@gmail.com
14	Unnatitai Chatrapal Chopde	9022627617	unnatichopde2002@gmail.com
15	Durgesh Krishna Singh	7385310432	ds608531@gmail.com
16	Bhagyarathi Ramvinay Pandey	9175302601	pandeybhagyarathi@gmail.com

Name & Signature of Teacher In-Charge

Prof. Pitambar Humane
IQAC Coordinator

CO ORDINATOR
INTERNAL QUALITY ASSURANCE CELL
DHARAMPETH, M. P. DEO MEMORIAL &
SCIENCE COLLEGE, NAGPUR

Name & Signature of Head of the Department

Jr. Varsha V Rangari
Professor & Head
Department of Electronics
Dharampeth M.P. Deo Memorial
Science College, Nagpur

Dr. Akhlesh Peshwe

Principal

Principal
Dharampeth M.P. Deo Memorial
Science College, Nagpur.



**DHARAMPETH M. P. DEO MEMORIAL SCIENCE COLLEGE,
NAGPUR**

INTERNAL QUALITY ASSURANCE CELL (IQAC)

Activity Report

Date: 21/12/2022

Name of Organizing Department or Committee: IQAC with Department of Home Science.

Name of the activity: Melghat Donation - Donation for food course

Suggested CRITERION point if any: II

Date of Activity: 21.12.2022

Place of Activity: Home Science Department

Name of Guest Speaker/s or Judge/s or Chief Guest/s if any:

Title of the Activity: Donation for food course.

Number of Students Participated : College Staff

Name of the Teacher In-charge / Convener:

Names of other Committee Members / Staff: HOD Manju Deshpande

OUTCOME of the Activity with respect to the mission vision of the institute and or academics: Practice allows the People to contribute to the growth & happiness of the Underprivileged People of Melghat By doing so we strive to touch the India's rural areas that lack even basic necessities such as food & clothing. So by joining hands with Bharat Vikas Parishad we try to bring cheers and happiness in the lives of such Tribal adivasis of Melghat

Activity with newspaper coverage if any:

Activity data save in PC of: Mrs Manju Deshpande



Prof. Pitambar Humane
IQAC Coordinator

CO ORDINATOR
INTERNAL QUALITY ASSURANCE CELL
DHARAMPETH, M. P. DEO MEMORIAL &
SCIENCE COLLEGE, NAGPUR

Name & Signature of Teacher In-charge

Dr. Akhilesh Peshwe
PRINCIPAL
Dharampeth M. P. Deo Memorial
Science College, Nagpur.



DHARAMPETH M. P. DEO MEMORIAL SCIENCE COLLEGE,
North Ambazari Road, Near Ambazari Lake, Nagpur-440033

DATA VALIDATION & VERIFICATION (DVV)

Name of the Programme : Melghat Donation - Donation for ^{Good} Cause

Date of the Programme : 21-12-22

Name of Chief Guest if any : _____

Name of Guest Speaker if any : _____

Sr. No.	Name of the Participant	Mobile Number	E-mail Id	Signature
01	Dr.			
02	Mrs. Mayu. M. Deshpande	9890064284	mayudeshpande1964@gmail.com	M Deshpande
03	Mrs. Ruma Kapre	9423110272	ruma.kapre@yahoo.com	Ruma Kapre
03	Ms. Ankita Wankhede	7756955562	ankitawankhede@gmail.com	Ankita
05	Prof. Vassha V. Rangari	9890364522	vangerivassha1@gmail.com	V. Rangari
05	Dr. Snehal A. Narale	9890336139	snehal.narale16@gmail.com	Snehal
08	Dr. H. P. Gaibwad	9423103820	hp.gaibwad@rediffmail.com	H. P. Gaibwad
08	Mr. R. W. Thakare	8983661335	r.thakare57@gmail.com	R. W. Thakare
08	U. Dr. P. W. Ambekar	7776899668	pauhc0701@gmail.com	P. W. Ambekar

Signature of:

Programme in-charge

CO ORDINATOR

INTERNAL QUALITY ASSURANCE CELL
DHARAMPETH, M. P. DEO MEMORIAL &
SCIENCE COLLEGE, NAGPUR

Principal

Dharampeth M. P. Deo Memorial
Science College, Nagpur.



DHARAMPETH M. P. DEO MEMORIAL SCIENCE COLLEGE, NAGPUR
INTERNAL QUALITY ASSURANCE CELL (IQAC)

Activity Report

Date: 22.12.22

Name of Organizing Department or Committee: Prevention of Sexual Harrassment
Name of the activity: Interaction with Girl Students in handling Peer Interaction & healthy Relationship

Suggested CRITERION point if any: VII

Date of Activity: 22.12.22

Place of Activity: Department of Home Science.

Name of Guest Speaker/s or Judge/s or Chief Guest/s if any: Dr. Prajakta .Kaduskar. "

Title of the Activity: Healthy Peer Interaction.

Number of Participants: 17

Name of the Teacher In-charge / Convener: Mrs Manju Deshpande : Convener, College Committee of Cell for prevention of Sexual Harrassment .

Names of other Committee Members / Staff:

OUTCOME of the Activity with respect to mission vision of the institute and or academics:

Healthy Interaction amongst the Peers

Managing relationship in the exogamous affiliations culture of Educational setting now a days

Name of Guest Speaker/s or Judge/s or Chief Guest/s if any: Dr. Prajakta .Kaduskar. "

Remove Inhibitions in developing hetero sexual relationship.

Activity with newspaper coverage if any: NIL

Activity data save in PC of: Mrs M M Deshpande

Note: Kindly share geotag photographs separately along with report on iqaedsc2022@gmail.com



Prof. Pitambar Humane
IQAC Coordinator
COORDINATOR
INTERNAL QUALITY ASSURANCE CELL
DHARAMPETH, M. P. DEO MEMORIAL &
SCIENCE COLLEGE, NAGPUR

Name & Signature of Teacher In-charge
Head, Department of Home Sci
Dharampeth M. P. Deo Memorial
Science College, Nagpur

Dr. Akhilesh Peshwe
Principal
Dharampeth M. P. Deo Memorial
Science College, Nagpur



DHARAMPETH M. P. DEO MEMORIAL SCIENCE COLLEGE,
North Ambazari Road, Near Ambazari Lake, Nagpur- 440033

DATA VALIDATION & VERIFICATION (DVV)

Sr. NO	Name	mobile number	email	Sign
1.	Nisha Arjun chormare	8669586501	Nishachormare50@gmail.com	
2.	Pranjakta Ashok Wakde	8459413596	pranjaktawakde4@gmail.com	
3.	Shabnam. Tapasw. madali	9022302785	Shabnammadali5@gmail.com	
4.	Deepika R. Yadav	9909746445	dy592200@gmail.com	
5.	Bhavti G. Harne	7057791359	bhavtiharne5@gmail.com	
6.	Kimaya N. Kote	8866073792	kimayakote005@gmail.com	
7.	Avani S. Shenwai	9096507459	Avanishenwai5@gmail.com	
8.	jasvi M. Wankhede	8767699751	wankhedejasvi@gmail.com	
9.	Priya K. Khawshi	9763617224	priyakhawshi3@gmail.com	
10.	Tannu S. Korde	7841984450	korde.tannu139@gmail.com	
11.	Pallavi B. Katre	2459277408	PKatre573@gmail.com	
12.	Pragya S. Tiwari	6394098386	Pragyatiwari14052003@gmail.com	
13.	Bhagyashree S. Ambule	9853138068	ambuleb662@gmail.com	
14.	Branali. H. Ghongadkar	9309079497	Branu02@gmail.com	

Signature of:

Jashpande
Head, Department of Science
Dharampeth M.P. Deo Memorial
Science College, Nagpur

COORDINATOR
INTERNAL QUALITY ASSURANCE CELL
DHARAMPETH, M. P. DEO MEMORIAL &
SCIENCE COLLEGE, NAGPUR

Principal
Dharampeth M.P. Deo Memorial
Science College, Nagpur.



DHARAMPETH M. P. DEO MEMORIAL SCIENCE COLLEGE, NAGPUR

INTERNAL QUALITY ASSURANCE CELL (IQAC)

Activity Report

Date: 22/12/2022

Name of Organizing Department or Committee: Department of Microbiology

Name of the activity: Poster making competition.

Suggested CRITERION point if any:

Date of Activity: 22/12/2022

Place of Activity: Department of Microbiology Dharampeth MP Deo Memorial Science College, Nagpur

Name of Guest Speaker/s or Judge/s or Chief Guest/s if any: Nil

Title of the Activity: Poster making competition on paper II unit I and II for SemV students.

Number of Participants: 33 students.

Name of the Teacher In-charge / Convener: Dr. Pratiksha V. Pohekar

Names of other Committee Members / Staff:

OUTCOME of the Activity with respect to mission vision of the institute and or academics:

- Posters making competition are helps to motivate students to learn specific topics.
- The best advantage of poster making is that it facilitates team work and understanding along with facilitating creative thinking and reading.
- It provides students with an opportunity to learn by doing, in turn strengthening the learning.
- Poster making and presentation is also an effective tool for evaluating the students' knowledge and creates opportunities for active discussion and participation.



Name & Signature of Teacher In-charge

**Prof. Pitambar Humane
IQAC Coordinator**

**Dr. Akhilesh Peshwe
Principal**

INTERNAL QUALITY ASSURANCE CELL
DHARAMPETH M. P. DEO MEMORIAL
SCIENCE COLLEGE, NAGPUR



DHARAMPETH M. P. DEO MEMORIAL SCIENCE COLLEGE,
North Ambazari Road, Near Ambazari Lake, Nagpur- 440033

DATA VALIDATION & VERIFICATION (DVV)

Name of the Programme : Poster making competition
Date of the Programme : 22/12/2022 (SEM V)
Name of Chief Guest if any : Nil
Name of Guest Speaker if any : Nil

Sr. No.	Name of the Participant	Mobile Number	E-mail Id	Signature
1.	Sayli S. Lokhande	9356413804	Sayalilokhande2910@gmail.com	
2.	Madhura U. Bhonde	8767484914	Madharabhondue@gmail.com	
3.	Samiksha N. Kundekar	9145253758	samikshakundekar@gmail.com	
4.	Samiksha R. Choudhary	7517090406	Choudharysamiksha26@gmail.com	
5.	Ayushi Shukla	9373668043	ayushishukla25112002@gmail.com	
6.	Shreyansh S. Naikwar	7447844189	shreyanshnaikwar7@gmail.com	
7.	Roshani M. Bambal	9325853408	roshani201866@gmail.com	
8.	Krushnali S. Kadam	8625854995	krushnaliadam67@gmail.com	
9.	Shivani S.R. Dwivedi	8855900546	shivaniidwivedi41@gmail.com	
10.	Bhumika D. Chedde	8830391105	bhumikachedde@gmail.com	

Signature of:

Programme In-charge

IQAC Coordinator

Principal
Dharampeth M. P. Deo Memorial
Science College, Nagpur



DHARAMPETH M. P. DEO MEMORIAL SCIENCE COLLEGE,
North Ambazari Road, Near Ambazari Lake, Nagpur- 440033

DATA VALIDATION & VERIFICATION (DVV)

Astha Sakhaswade	9405197842	asthasakhaswade@gmail.com	Astha Swade
Ranjali L. Dondet	9325473318	dondetranjali06@gmail.com	R Dondet
Suroj Jalew	876763515P	SurojSlyowwadaw2@gmail.com	Suroj
Sanket Lode	7972085380	SanketLode123@gmail.com	Sanket
Avanti Daphekar	7875173847	avanti11011@gmail.com	Avanti
Shruti M. Pawar	9527988707	ShrutiPawar000@gmail.com	Shruti
Aishwarya A. Joshi	8956169223	aishwaryajoshi2003@gmail.com	Aishwarya
Tanmay Choudhary	8600102341	tchoudhary8600@gmail.com	Tanmay
Vivek P. Walburwale	8956482591	VivekWalburwale@gmail.com	Vivek
Manish S. Grade	9370929857	ManishGrade79@gmail.com	Manish
Tejas. G. Solanke	703073067	TejasSolanke08@gmail.com	Tejas
Nandini S. Hodge	9370301679	nandinihodge17@gmail.com	Nandini
Ishika S. Thakre	8010907069	ishithakre@gmail.com	Ishika
Anjali R. Pali	7498102109	palianjali44@gmail.com	Anjali
Anushi S. Wale	8530778433	anushiwale2001@gmail.com	Anushi

Signature of:

Anurag
Programme In-charge

[Signature]
COORDINATOR
IQAC Coordinator

[Signature]
Principal
Dharampeth M. P. Deo Memorial
Science College, Nagpur
Principal



DHARAMPETH M. P. DEO MEMORIAL SCIENCE COLLEGE,
North Ambazari Road, Near Ambazari Lake, Nagpur- 440033

DATA VALIDATION & VERIFICATION (DVV)

Lakmi Goude	7758058514	laxmigoode2908@gmail.com	<u>Lakmi Goude</u>
Bhargavi A. Sambare	7709403806	bhargavisambare.05@gmail.com	<u>Bhargavi</u>
Isha Gupta	9873259849	isha.1202.gupta@gmail.com	<u>Isha</u>
Ankita. Bhoyat	8788031173	ankitabhoyat@gmail.com	<u>Ankita</u>
Neha J. Chandrase	9370570833	nehachandrase346@gmail.com	<u>Neha</u>
Rakhi Wadde	9420396682	rahikawadde4@gmail.com	<u>Rakhi</u>
Rupesh W. Wadde	8329676611	Rupeshwadde780@gmail.com	<u>Rupesh</u>

Signature of:

[Signature]
Programme In-charge

[Signature]
CO-ORDINATOR
INTERNAL IQAC COORDINATOR

INTERNAL IQAC COORDINATOR
DHARAMPETH M. P. DEO MEMORIAL &
SCIENCE COLLEGE, NAGPUR

Principal
Dharampeth M. P. Deo Memorial
Science College, Nagpur



DHARAMPETH M. P. DEO MEMORIAL SCIENCE COLLEGE, NAGPUR
INTERNAL QUALITY ASSURANCE CELL (IQAC)

Activity Report

Date: 22/12/2022

Name of Organizing Department or Committee: Department of Microbiology

Name of the activity: Model making competition.

Suggested CRITERION point if any:

Date of Activity: 22/12/2022

Place of Activity: Department of Microbiology Dharampeth MP Deo Memorial Science College, Nagpur

Name of Guest Speaker/s or Judge/s or Chief Guest/s if any: Nil

Title of the Activity: Model making competition on paper II unit I for SemV students.

Number of Participants: 28

Name of the Teacher In-charge / Convener: Dr. Pratiksha V. Pohekar

Names of other Committee Members / Staff:

OUTCOME of the Activity with respect to mission vision of the institute and or academics:

- It helps to motivate students to learn specific topics.
- The best advantage of model making is that it facilitates team work and understanding along with facilitating creative thinking and reading.
- Students are able to visually represent the key points and while presenting elaborate on the same which facilitates their retention and recall of events and facts.



1981A, Ambazari Layout,
Verma Layout, Sudam
Nagar, Ram Nagar, Nagpur,
22 Dec 2022 02:14 PM

haze
29.0 °C



1981A, Ambazari Layout,
Verma Layout, Sudam
Nagar, Ram Nagar, Nagpur,
22 Dec 2022 02:21 PM

haze
29.0 °C

Name & Signature of Teacher In-charge

Prof. Pitambar Humane

IQAC Coordinator

INTERNAL QUALITY ASSURANCE CELL
DHARAMPETH, M. P. DEO MEMORIAL &
SCIENCE COLLEGE, NAGPUR

Dr. Aldhilesh Peshwe

Principal



DHARAMPETH M. P. DEO MEMORIAL SCIENCE COLLEGE,
North Ambazari Road, Near Ambazari Lake, Nagpur- 440033

DATA VALIDATION & VERIFICATION (DVV)

Name of the Programme : Modal making competition.
Date of the Programme : 22/12/22 (Sem V)
Name of Chief Guest if any : Nil
Name of Guest Speaker if any : Nil

Sr. No.	Name of the Participant	Mobile Number	E-mail Id	Signature
7.	Madhura U. Bhondure	8767484914	Madhurasbhondure@gmail.com	M. Bhondure
8.	Anjali R. Pali	7498102109	pali.anjali46@gmail.com	[Signature]
9.	Anushree S. Wele	8530778433	anushree2001@gmail.com	[Signature]
10.	Ishika S. Thakre	8010907069	ishikathakre2@gmail.com	[Signature]

Signature of:

[Signature]
Programme In-charge

[Signature]
IQAC Coordinator

CO-ORDINATOR
QUALITY IMPROVEMENT CELL
DHARAMPETH M. P. DEO MEMORIAL &
SCIENCE COLLEGE, NAGPUR

Dharampeth M. P. Deo Memorial
Science College, Nagpur



DHARAMPETH M. P. DEO MEMORIAL SCIENCE COLLEGE,
North Ambazari Road, Near Ambazari Lake, Nagpur- 440033

DATA VALIDATION & VERIFICATION (DVV)

Sayali S. Lokhandi	9356413804	scupali@gmail.com	
Sanskruiti Panchabhawe	7447613185	sanskruiti@gmail.com	
Shreyansh S. Naikwar	7447844189	shreyanshnaikwar7@gmail.com	
Nandini S. Hadge	9370301679	nandinihadge17@gmail.com	
Bhargavi A. Sambase	7709603805	bhargavisambase05@gmail.com	
Roshani M. Batabal	9325853608	roshani201866@gmail.com	
Kaushikma S. Bamsod	9388011507	kaushikma.bamsod@gmail.com	
Neha J. Chandran	9370570833	nehachandranhe246@gmail.com	
Ankita R. Bhoyar	8788031173	ankitabhoyar06@gmail.com	
Manali S. Shinde	7249637434	manalishinde062@gmail.com	
Sayali S. Lokhande	9356413804	sayalilokhande2910@gmail.com	
isha B. Gupta	9373269849	isha1202.gupta@gmail.com	
Asmita A. Sakhasale	9405197842	ashtasakha@gmail.com	
Aranti Bhagat	7538367348	chandabhagat45@gmail.com	
Arati Chavhanekar	7875173847	aranti101@gmail.com	

Signature of

Program In-charge

COORDINATOR
QUALITY ASSURANCE CELL
IQAC Coordinator

Principal
Dharampeth M. P. Deo Memorial
Science College, Nagpur



DHARAMPETH M. P. DEO MEMORIAL SCIENCE COLLEGE, NAGPUR
INTERNAL QUALITY ASSURANCE CELL (IQAC)

Activity Report

Date: 28th Dec., 2022

Name of Organizing Department or Committee: BOTANY DEPARTMENT

Name of the activity: Puzzle Preparation (NEP-2022 Activity)

Suggested CRITERION point if any: CRITERION-I

Date of Activity: 23rd Dec., 2022

Place of Activity: Botany Laboratory

Name of Guest Speaker/s or Judge/s or Chief Guest/s if any:

Title of the Activity: To prepare word puzzle on Systematic Botany

Number of Participants: 31

Name of the Teacher In-charge / Convener: Prof. Pitambar Humane

Names of other Committee Members / Staff: Dr. Chandrakumar Patle, Mr. Amol Pimpalshende, Dr. Mrs. Reshma Hiwase, Dr. Mrs. Sweta Rai & Mrs. Dipali Nikure

OUTCOME of the Activity with respect to mission vision of the institute and or academics:

Active participation of the students in preparation of word puzzle increases their knowledge in the subject. Students tried to use different terminology in preparation of the puzzles. Different students created different puzzles by their own creativity. Various words from systematic botany learned by the students in this activity. Many students created the puzzles with innovative ideas. All the students prepared and submitted the word puzzles to the botany department.

Activity with newspaper coverage if any: NA

Activity data save in PC of: Prof. Pitambar Humane's Laptop

Name & Signature of Teacher In-charge

Prof. Pitambar Humane
IQAC Coordinator

CO ORDINATOR

INTERNAL QUALITY ASSURANCE CELL
DHARAMPETH, M. P. DEO MEMORIAL &
SCIENCE COLLEGE, NAGPUR

Dr. Akhilesh Peshwe
Principal

Dharampeth M.P. Deo Memorial
Science College, Nagpur.



DHARAMPETH M. P. DEO MEMORIAL SCIENCE COLLEGE,
North Ambazari Road, Near Ambazari Lake, Nagpur- 440033

DATA VALIDATION & VERIFICATION (DVV)

Name of the Programme : To prepare word puzzle on systematic Botany
Date of the Programme : 23rd Dec, 2022
Name of Chief Guest if any : _____
Name of Guest Speaker if any : _____

Sr. No.	Name of the Participant	Mobile Number	E-mail Id	Signature
1.	Vaibhav Arun Malewar	8767838219	vaibhavamalewar794@gmail.com	
2.	Nikita S. Parapatne	7058625053	parachibapatne@gmail.com	
3.	Chirayu B. Dolas	8010135012	chirayudolas22@gmail.com	
4.	Sagar S. Bawane	9975460979	sagarbawane6376@gmail.com	
5.	Yukti S. Choudhary	7020953938	yukti.choudhary102@gmail.com	
6.	Vilash D. Hullar	8624091652	hullkenilashy@gmail.com	
7.	Devashish D. Bisen	7767861231	Devashishbisen21@	
8.	Nikhil R. Raut	9022680159	cautr1541@gmail.com	
9.	Anushree Chandel	9145631751	anuchandel2001@gmail.com	
10.	Aditya A. Dalkar	9028915776	dalkaraditya@gmail.com	

Signature of

Programme In-charge

IQAC COORDINATOR
INTERNAL QUALITY ASSURANCE CELL
DHARAMPETH, M. P. DEO MEMORIAL &
SCIENCE COLLEGE, NAGPUR

Principal
Principal
Dharampeth M.P. Deo Memorial
Science College, Nagpur



DHARAMPETH M. P. DEO MEMORIAL SCIENCE COLLEGE,
North Ambazari Road, Near Ambazari Lake, Nagpur- 440033

DATA VALIDATION & VERIFICATION (DVV)

11.	Chauvi. A. Rawat	9767873447	ankurawar2003@gmail.com	Chauvi
12.	Ayina R. Sheikh	8080083981	ayinashikh973@gmail.com	Sheikh
13.	Smruti Vaidya	8856908764	SmrutiVaidya36@gmail.com	Vaidya
14.	Jagruti A Rawat	9265818046	309Euthasit Rawat 58@gmail	Rawat
15.	Ketaki R. Karpal	9112759066	KetakiKarpal 13@gmail.com	Karpal
16.	Muskan R. Yadav	9579492617	muskanycadav1225@gmail.com	Yadav
17.	Ayush A. Kadam	9163013263	ak7855036@gmail.com	Ayush
18.	Abhishek Dshbheekar	8208302902	abhishekashbheekar@gmail.com	Abhishek
19.	Shikha J. Yadav	7263881320	Shikha.Yadav.Sy@gmail.com	S.J.Yadav
20.	Subbu R. Mishra	9860436418	Subbumishra22@gmail.com	Subbu
21.	Sudhanshu Witek	7025429173	SudhanshuWitek143@gmail.com	Witek
22.	Devashri D. Bisen	8698119078	DKBisenTU@gmail.com	Bisen
23.	Devesh S. Longadge	9326246553	deveshlongadge@gmail.com	Devesh
24.	Kalyani C. Shahare	9307046378	ShahareKalyaniS@gmail.com	Kalyani
25.	Vaishnavi T. Kapse	8983751059	vaishnavikapse05@gmail.com	Vaishnavi
26.	Nikita S. Bhawe	9860153628	NikitaBhawe@gmail.com	Nikita

Signature of

Programme In-charge

IQAC Coordinator
COORDINATOR
INTERNAL QUALITY ASSURANCE CELL
DHARAMPETH, M. P. DEO MEMORIAL &
SCIENCE COLLEGE, NAGPUR

Principal
Principal
Dharampeth M.P. Deo Memorial
Science College, Nagpur.



DHARAMPETH M. P. DEO MEMORIAL SCIENCE COLLEGE, NAGPUR
INTERNAL QUALITY ASSURANCE CELL (IQAC)

Activity Report

Date: 28th Dec., 2022

Name of Organizing Department or Committee: BOTANY DEPARTMENT

Name of the activity: Field study (NEP-2022 Activity)

Suggested CRITERION point if any: CRITERION-1

Date of Activity: 23rd Dec., 2022

Place of Activity: College Premises

Name of Guest Speaker/s or Judge/s or Chief Guest/s if any: NA

Title of the Activity: To study angiosperms found in college campus

Number of Participants: 30

Name of the Teacher In-charge / Convener: Prof. Pitambar Humane

Names of other Committee Members / Staff: Dr. Chandrakumar Patle, Mr. Amol Pimpalshende, Dr. Mrs. Reshma Hiwase, Dr. Mrs. Sweta Rai & Mrs. Dipali Nikure

OUTCOME of the Activity with respect to mission vision of the institute and or academics:

The students studied number of herbs, shrubs and trees in college premises. The scientific names were provided to the students so that they can know the local flora around us.

Activity with newspaper coverage if any: NA

Activity data save in PC of: Prof. Pitambar Humane's Laptop



Prof. Pitambar Humane
IQAC Coordinator

CO ORDINATOR
INTERNAL QUALITY ASSURANCE CELL
DHARAMPETH, M. P. DEO MEMORIAL &
SCIENCE COLLEGE, NAGPUR

Name & Signature of Teacher In-charge

Dr. Akhilesh Peshwe
Principal

Dharampeth M.P. Deo Memorial
Science College, Nagpur.



DHARAMPETH M. P. DEO MEMORIAL SCIENCE COLLEGE,
North Ambazari Road, Near Ambazari Lake, Nagpur- 440033

DATA VALIDATION & VERIFICATION (DVV)

Name of the Programme

: To study plants in Botanical Garden &

Date of the Programme

: College Campus 23rd Dec. 2022

Name of Chief Guest if any

:

Name of Guest Speaker if any

:

Sr. No.	Name of the Participant	Mobile Number	E-mail Id	Signature
1	Ketaki R. Kirpal	9112759066	ketakikirpal12@gmail.com	Kirpal
2	Afsina R. Sheikh	8080083981	afsinasheikh973@gmail.com	Sheikh
3	Nikita S. Bangapatole	7058625653	nikitabangapatole@gmail.com	Bangapatole
4	Gauri A. Raut	9767873447	ankusraut2003@gmail.com	G. Raut
5	Nilesh D. Hulke	8624091652	hullrenilesh@gmail.com	Hulke
6	Smriti Vaidya	8956908764	SmritiVaidya36@gmail.com	Vaidya
7	Nikhil R. Raut	9022680159	rautn0541@gmail.com	Raut
8	Anushree Chandel	9145631751	anuchandel2001@gmail.com	Chandel
9	Aditya Deulkar	9028915776	deulkaraditya27@gmail.com	Deulkar
10	AYUSH A. KADAM	9763013263	ak9855036@gmail.com	Kadam

Signature of

Programme In-charge

IQAC COORDINATOR
INTERNAL QUALITY ASSURANCE CELL
DHARAMPETH, M. P. DEO MEMORIAL &
SCIENCE COLLEGE, NAGPUR

Principal
Dharampeth M.P. Deo Memorial
Science College, Nagpur



DHARAMPETH M. P. DEO MEMORIAL SCIENCE COLLEGE,
North Ambazari Road, Near Ambazari Lake, Nagpur- 440033

DATA VALIDATION & VERIFICATION (DVV)

11.	Devrajshai Dnyudham. Bikan	8698119078	DICR18en7u@gmail.com	Bikan
12.	Muskan Rameshwar yadav	9579492617	muskan Yadav122@gmail.com	Muskan
13.	Yukti Suresh Choudhary	7020953938	yukti.choudhary1502@gmail.com	Yukti
14.	Devraj Sanjay Longadge	9326246453	devrajlongadge@gmail.com	Devraj
15.	Abhishale Deshbhreatore	8208302902	abhishale Deshbhreatore@gmail.com	Abh.
16.	Sudhanshu Utkay	7026429173	SudhanshuUtkay199@gmail.com	Sudhanshu
17.	Chirayu B. Ddau	8010135012	Chirayudolai22@gmail.com	Chirayu
18.	Sagar S. Bawane	9975460979	Sagarbawane37@gmail.com	S.Bawane
19.	Kalyani C. Shahare	9507046378	Dhaharekalyani5@gmail.com	K
20.	Vaibhav Anun Malawar	8767838219	vaibhavmalawar74@gmail.com	V.Malawar
21.	Shital G. Banker	7758055139	Shitalbanker22@gmail.com	S.G.Banker
22.	Vaishnavi T. Kapre	8983751089	vaishnavikapre5@gmail.com	Vaishnavi
23.	Nikita S. Bhave	9860159628	NikitaBhave@gmail.com	Nikita
24.	Anchal S. Singh	7875537925	SandoshSingh23423@gmail.com	Anchal Singh
25.	Tanushree R. Bhagat	9834968808	tanubhagat1227@gmail.com	Tanushree
26.	Subbu R. Mishra	9860436418	SubbuR18@gmail.com	Subbu

Signature of:

Programme In-charge

IQAC Coordinator

CO ORDINATOR
INTERNAL QUALITY ASSURANCE CELL
DHARAMPETH, M. P. DEO MEMORIAL &
SCIENCE COLLEGE, NAGPUR

Principal

Principal
Dharampeth M.P. Deo Memorial
Science College, Nagpur



DHARAMPETH M. P. DEO MEMORIAL SCIENCE COLLEGE, NAGPUR
INTERNAL QUALITY ASSURANCE CELL (IQAC)

Activity Report

Date: 28th Dec., 2022

Name of Organizing Department or Committee: BOTANY DEPARTMENT

Name of the activity: Field study (NEP-2022 Activity)

Suggested CRITERION point if any: CRITERION-I

Date of Activity: 23rd Dec., 2022

Place of Activity: Botany Laboratory

Name of Guest Speaker/s or Judge/s or Chief Guest/s if any: NA

Title of the Activity: Question Bank Discussion (B. Sc. Sem.-III)

Number of Participants: 32

Name of the Teacher In-charge / Convener: Prof. Pitambar Humane

Names of other Committee Members / Staff: Dr. Chandrakumar Patle, Mr. Amol Pimpalshende, Dr. Mrs. Reshma Hiwase, Dr. Mrs. Sweta Rai & Mrs. Dipali Nikure

OUTCOME of the Activity with respect to mission vision of the institute and or academics:

After covid-19 pandemic the examinations are held in offline mode in subjective manner hence this activity was very important for the student to prepare for university examinations. During the activity, all the topics of each paper were discussed along with all possible questions to be asked in university examinations. Also, the patten of marking as well as way of answer sheet writing convened to the students

Activity with newspaper coverage if any: NA

Activity data save in PC of: Prof. Pitambar Humane's Laptop

Prof. Pitambar Humane
IQAC Coordinator
CO ORDINATOR
INTERNAL QUALITY ASSURANCE CELL
DHARAMPETH, M. P. DEO MEMORIAL &
SCIENCE COLLEGE, NAGPUR

Name & Signature of Teacher In-charge

Dr. Akhilesh Peshwe
Principal
Principal
Dharampeth M.P. Deo Memorial
Science College, Nagpur.



DHARAMPETH M. P. DEO MEMORIAL SCIENCE COLLEGE,
North Ambazari Road, Near Ambazari Lake, Nagpur- 440033

DATA VALIDATION & VERIFICATION (DVV)

Name of the Programme : Question Bank Discussion (sem.-III)
Date of the Programme : 23rd Dec, 2022
Name of Chief Guest if any : _____
Name of Guest Speaker if any : _____

Sr. No.	Name of the Participant	Mobile Number	E-mail Id	Signature
①	Mkita .s. parapatule	7058625053	parachigauapatule05@gmail.com	<u>parapatule</u>
2.	nilesh .D. Hullke	8626091652	hulkenilesh@gmail.com	<u>Hullke</u>
3]	Nikhil .R. Raut	8022680159	scutn654@gmail.com	<u>Raut</u>
4]	Jagruiti A Rawat	9265818046	JagruitiArawat50@gmail.com	<u>Rawat</u>
5]	Anushree chandel	9145631751	anuchandel2001@gmail.com	<u>Chandel</u>
6]	Gaurvi .A. Raut	9767873447	gaurviraut2003@gmail.com	<u>G. Raut</u>
7.	Afrina R. Sheikh	8080083981	afsinasheikh973@gmail.com	<u>Sheikh</u>
8.	Smriti Vaidya	8856908964	SmritiVaidya36@gmail.com	<u>Smriti Vaidya</u>
9.	Yukti Chaudhary	7020953938	yukti.chaudhary162@gmail.com	<u>Yukti</u>
10.	Ketaki Kirpal	8112759066	KetakiKirpal12@gmail.com	<u>Kirpal</u>

Signature of

Programme In-charge

IQAC Coordinator

COORDINATOR
INTERNAL QUALITY ASSURANCE CELL
DHARAMPETH, M. P. DEO MEMORIAL &
SCIENCE COLLEGE, NAGPUR

Principal
Principal

Dharampeth M.P. Deo Memorial
Science College, Nagpur.



DHARAMPETH M. P. DEO MEMORIAL SCIENCE COLLEGE,
North Ambazari Road, Near Ambazari Lake, Nagpur- 440033

DATA VALIDATION & VERIFICATION (DVV)

11.	Aditya. C. Dalkar	9028415446	dalkaraditya7@gmail.com	Dalkar
12.	Ayush A. Kadam	9163013263	AK2855036@gmail.com	Ayush
13.	Sagar S. Bawane	9975460979	sagarbawane637@gmail.com	Sagar
14.	Chirayu B. Dolat	8010135012	chirayudolat22@gmail.com	Chirayu
15.	Vaibhav Arun Malawadi	8767838219	vaibhavamalawadi@gmail.com	Vaibhav
16.	Jagriti A. Rawat	9265818046	jagritijirawat58@gmail.com	Jagriti
17.	Devashri. D. Bisen	8698119078	DKB8en14@gmail.com	Devashri
18.	Muskan. R. Yadav	9579492617	muskan.yadav.122@gmail.com	Muskan
19.	Devesh Sanjay Longadge	9326246453	deveshlongadge@gmail.com	Devesh
20.	Nikita -S. Bhave	9860159628	nikitabhav@gmail.com	Nikita
21.	Abhishek Dashbhavtare	8208302902	abhishekdashbhavtare@gmail.com	Abhishek
22.	Kalyani C. Shahare	9307046378	shaharekalyani3@gmail.com	Kalyani
23.	Sudhanshu Vitay	7025429173	Sudhanshuvitay142@gmail.com	Sudhanshu
24.	Subbu Mishra	9860436418	subbumishra@gmail.com	Subbu
25.	Shital G. Bantre	7758055139	shitalbantre22@gmail.com	S.G. Bantre
26.	Ashikha J. Yadav	7263881320	Ashikha.yadav.57@gmail.com	S.J. Yadav

Signature of

Programme In-charge

IQAC Coordinator CO ORDINATOR

INTERNAL QUALITY ASSURANCE CELL
DHARAMPETH, M. P. DEO MEMORIAL &
SCIENCE COLLEGE, NAGPUR

Principal
Principal

Dharampeth M.P. Deo Memorial
Science College, Nagpur.



DHARAMPETH M. P. DEO MEMORIAL SCIENCE COLLEGE,
North Ambazari Road, Near Ambazari Lake, Nagpur- 440033

DATA VALIDATION & VERIFICATION (DVV)

27.	Vaishnavi T. Kapse	8983751089	vaishnavikapse05@gmail.com	vaishnavi
28.	Aanchal S. Singh	7875537925	sanjoshsingh23923@gmail.com	Aanchal Singh
29.	Tanushree R. Bhogal	9834968808	tanushbhogal1227@gmail	Tanush
30.	Shruti Mangesh. Pawar	9322056207	sp997494@gmail.com	Shruti
31.	Shobha R. Shalkh.	8329346137	shobha107.k@gmail.com	Shobha
32.	Devesh D. Bisen	7767561231	Deveshbisen15	D

Signature
Programme In-charge

IQAC COORDINATOR
INTERNAL QUALITY ASSURANCE CELL
DHARAMPETH, M. P. DEO MEMORIAL &
SCIENCE COLLEGE, NAGPUR

Principal
Dharampeth M.P. Deo Memorial
Science College, Nagpur.



DHARAMPETH M. P. DEO MEMORIAL SCIENCE COLLEGE, NAGPUR

**INTERNAL QUALITY ASSURANCE CELL (IQAC)
Activity Report**

Date: 23/12/2022

Name of Organizing Department or Committee: Department of Physics

Name of the activity: NEP based Demonstration Activity for B.Sc. Semester-III

Suggested CRITERION point if any: Restricted to RTMNU B.Sc. physics syllabus.

Date of Activity: 23/12/2022

Place of Activity: Physics Laboratory of the Department

Name of Guest Speaker/s or Judge/s or Chief Guest/s if any: NA

Title of the Activity: Demonstration on Laboratory measurement of c . (Calculation of speed of light)

Activity with newspaper coverage if any: No

Number of Participants: B.Sc. Semester-III Students – 41

Name of the Teacher In-charge / Convener: Ms. Amrapali K. Meshram

Names of other Committee Members / Staff: N.A.

OUTCOME of the Activity with respect to academics:

The students were made to learn how to measure velocity of light. In this activity, the concept of velocity of light including permeability and permittivity of free space and in air were learned. In addition to this a theoretical calculation was made by the students and the value of speed of light through vacuum is calculated. The relation $c = 1/(\sqrt{\mu_0 \epsilon_0})$ is understood and the value is calculated.

DVV: Enclosed.

Activity data save in PC of: Lt. Dr. P. W. Ambekar

Prof. Pitambar Humane
IQAC Coordinator

CO ORDINATOR
INTERNAL QUALITY ASSURANCE CELL
DHARAMPETH M. P. DEO MEMORIAL &
SCIENCE COLLEGE, NAGPUR

Name & Signature of Teacher In-charge

Dr. Akhilesh Peshwe
Principal
Principal
Dharampeth M.P. Deo Memorial
Science College, Nagpur.



DHARAMPETH M. P. DEO MEMORIAL SCIENCE COLLEGE NAGPUR

Department of Physics

Class: B.Sc. Sem.-III

NEP ACTIVITY

Paper- 2

Unit- 4

Name of the Teacher: Anapali Meshram

Date: 23/12/2022

Title of Activity: Demonstration on Laboratory mammout of c

Sr. No.	Name of Student	Batch	Mobile No.	Email ID	Signature
---------	-----------------	-------	------------	----------	-----------

1	Mansi Ashok Badole	S-8	7796368467	mansibadole@gmail.com	<u>Badole</u>
2	Jasraj Dewital Palival	S-8	9370820325	jasrajpalival47@gmail.com	<u>Jasraj</u>
3	Kajal P. Nighot	S-8	9377250629	kajalnighot2003@gmail.com	<u>Nighot</u>
	Shweta Ramteke	S-9	8857031895	sishandis81@gmail.com	<u>Shweta</u>
5)	Atharva Vinod Ingale	S-7	922468636	atharvaingale77@gmail.com	<u>Atharva</u>
6)	Ausmi A. K. Sheikh	S-3	8168323568	ausmi5029@gmail.com	<u>Sheikh</u>
7)	Prityansha S. Shah	S-3	7385197365	P53347311@gmail.com	<u>Prityansha</u>
8)	Shweta Bedwal	S-5	8080440184	ShwetaBedwal2005@gmail.com	<u>Bedwal</u>
9)	Ritul Bisen	S-5	7028510840	ritulbisen06@gmail.com	<u>Bisen</u>
10)	Mansi Sham Fating	S-8	8767134686	mansyfating2110@gmail.com	<u>Fating</u>
11)	Atharav P. Urate	S-5	9284641511	atharavurate@gmail.com	<u>Urate</u>
12)	Ayush R. Boniker	S-5	9579445092	ayushboniker4@gmail.com	<u>Boniker</u>
13)	Sakshi Ingle	S-9	9067871694	inglesakshi703@gmail.com	<u>Ingle</u>
14)	Shroaddha Rajc	S-10	776804083	shroaddhrajc4@gmail.com	<u>Rajc</u>
15)	Simran Patmale	S-10	799253083	SimranPatmale@gmail.com	<u>Patmale</u>
16)	Komal S. Patle	S-8	9881768506	komalpatle2304@gmail.com	<u>Patle</u>
17)	Aditi Lute	S-5	7820812303	aditilute101@gmail.com	<u>Lute</u>
18)	Amy H. Mishra	S-5	8103656208	amyhishra251202@gmail.com	<u>Mishra</u>
19)	Ananya R. Molghare	S-7	7219218955	ananya.molghare@gmail.com	<u>Molghare</u>
20)	Apurva S. Verutkar	S-7	9623613911	apurva.verutkar@gmail.com	<u>Verutkar</u>
21)	Nupur Sharma	S-8	9322042259	nupursharma2003@gmail.com	<u>Sharma</u>
22)	Prakhar Bhatnagar	S-3	8329760853	Prakhar.Bhatnagar56@gmail.com	<u>Bhatnagar</u>
23)	Bhagyashree Thakare	S-5	8766925295	thakarebhagyashree90@gmail.com	<u>Thakare</u>
24)	Damini Katre	S-5	8208255685	daminikatre@gmail.com	<u>Katre</u>

Signature of Teacher

19) Aditya Singh S-5 7350543901
20) Dinesh Parthi S-7 9623380674

Head of Department

aditya.singh280180@gmail.com A.H.S.
parthidhiman11@gmail.com Din

19) Sauchita Patil	S-5	2218060185	sauchitapatil2009@gmail.com	Sauchita
20) Nutan Surjuse	S-5	8805570279	nutansurjuse@gmail.com	Nutan
21) Aditya Kumar Shukla	S-5	9518994638	adityashukla007@gmail.com	Aditya
22) Nitin Keshwaha	S-5	9693429005	nitinkeshwaha@gmail.com	Nitin
23) Divya Hanote	S-8	8605422901	divyahanote@gmail.com	Divya
24) Prachit R. Kotraliwar	S-9	7498102097	Prachitkotraliwar@gmail.com	Pra
25) Kumal Digrao	S-5	8010271303	Kumaldigrao@gmail.com	Kumal
26) P				
27) Chetan Bopche	S-3	9172484628	chetanbopche27@gmail.com	Chetan
28) Bhumika V. Thakre	S-7	7218247917	Bhumikenthakre55@gmail.com	Bhumika
29) Vrushali Shahane	S-1	9307516332	Vrushalishahane23@gmail.com	Vrushali
30) Ruchika Patle	S-9	8669335907	ruchikapatle@gmail.com	Ruchika
31) Swanandidharne	S-10	7420880982	Swanandidharne5@gmail.com	Swanandidharne
32) Ashmit Jwan	S-7	8080238161	ashmitjwan@gmail.com	Ashmit
33) Roshali D. Bhaskar	S-9	957948597	bhaskarroskali@gmail.com	Roshali
34) Pawan S. Vishwakarma	S-3	7058408869	pawanvishwakarma@gmail.com	Pawan
35) Dharmapuri Lal	S-7	9975031356	dharmapurihiraj@gmail.com	Dharmapuri
36) Omkumar D. Devangan	S-5	9763624388	ommamajiiz@gmail.com	Devangan
37) Akshay P. Khandare	S-5	7350956804	akshaykhandare79@gmail.com	Akshay
38) Harik. C. Mishra	S-7	9067447777	kumarharishankar@gmail.com	Harik
39) Hitesh G. Kamare	S-5	7059427112	hiteshkamare73@gmail.com	Hitesh
40) Vaishu S. Nimje	S-9	9579998869	vaishunimje2007@gmail.com	Vaishu
41) Vatan S. Somwade	S-9	9975410765	vatanSomwade@gmail.com	Vatan



HEAD
DEPARTMENT OF PHYSICS
Dharampeth M. P. Deo Memorial
Science College, Nagpur



DHARAMPETH M. P. DEO MEMORIAL SCIENCE COLLEGE, NAGPUR
INTERNAL QUALITY ASSURANCE CELL (IQAC)

Activity Report

Date: 28th Dec., 2022

Name of Organizing Department or Committee: BOTANY DEPARTMENT

Name of the activity: Field study (NEP-2022 Activity)

Suggested CRITERION point if any: CRITERION-I

Date of Activity: 24th Dec., 2022

Place of Activity: Botany Laboratory

Name of Guest Speaker/s or Judge/s or Chief Guest/s if any: NA

Title of the Activity: Question Bank Discussion (B. Sc. Sem.-V)

Number of Participants: 29

Name of the Teacher In-charge / Convener: Prof. Pitambar Humane

Names of other Committee Members / Staff: Dr. Chandrakumar Patle, Mr. Amol Pimpalshende, Dr. Mrs. Reshma Hiwase, Dr. Mrs. Sweta Rai & Mrs. Dipali Nikure

OUTCOME of the Activity with respect to mission vision of the institute and or academics:

After covid-19 pandemic the examinations are held in offline mode in subjective manner hence this activity was very important for the student to prepare for university examinations. During the activity, all the topics of each paper were discussed along with all possible questions to be asked in university examinations. Also, the patten of marking as well as way of answer sheet writing convened to the students

Activity with newspaper coverage if any: NA

Activity data save in PC of: Prof. Pitambar Humane's Laptop

Prof. Pitambar Humane
IQAC Coordinator
CO ORDINATOR
INTERNAL QUALITY ASSURANCE CELL
DHARAMPETH, M. P. DEO MEMORIAL &
SCIENCE COLLEGE, NAGPUR

Name & Signature of Teacher In-charge

Dr. Akhilesh Peshwe
Principal
Principal
Dharampeth M.P. Deo Memorial
Science College, Nagpur.



DHARAMPETH M. P. DEO MEMORIAL SCIENCE COLLEGE,
North Ambazari Road, Near Ambazari Lake, Nagpur- 440033

DATA VALIDATION & VERIFICATION (DVV)

Name of the Programme : Question Bank Discussion (Sem V)
Date of the Programme : 24th Dec, 2022
Name of Chief Guest if any : _____
Name of Guest Speaker if any : _____

Sr. No.	Name of the Participant	Mobile Number	E-mail Id	Signature
1	Krushnali S. Kadu	8625854995	krushnalikadu467@gmail.com	
2	Sakshi S. Gawai	9529660277	sakshigisai2001@gmail.com	
3	Jayashree D. Hiwase	7385473157	Juthihiwase10@gmail.com	J. D. Hiwase
4	Aepita T. Dakhale	8010866755	aspiradakhale@gmail.com	
5	Rinam C. Wankhede	8010866529	wankhedeerinam@gmail.com	
6	Madhura U. Bhondwe	8767484914	MadhuraBhondwe@gmail.com	
7	Asha S. Lunde	9322231551	ashalundge001@gmail.com	
8	Neha R. Kharwase	8766798940	neha2002kk@gmail.com	
9	Vishakha G. Gowhade	7620351270	vishakha2009@gmail.com	
10	Shreyansh S. Naikwad	7447844189	shreyanshnaikwad@gmail.com	

Signature of _____

Programme In-charge

IQAC Coordinator **ORDINATOR**
INTERNAL QUALITY ASSURANCE CELL
DHARAMPETH, M. P. DEO MEMORIAL &
SCIENCE COLLEGE, NAGPUR

Principal
Principal

Dharampeth M.P. Deo Memorial
Science College, Nagpur.



DHARAMPETH M. P. DEO MEMORIAL SCIENCE COLLEGE,
North Ambazari Road, Near Ambazari Lake, Nagpur- 440033

DATA VALIDATION & VERIFICATION (DVV)

11.	Bhumika D. chedge	8830391103	bhumikachedge@gmail.com	Bhedge
12.	Vivek R. Wakhare	8956482591	vivek.wakhare@gmail.com	Vivek
13.	Samiksha N. kuntekar	9145253158	samikshakuntekar@gmail.com	Samiksha
14.	Sushila S. Puri	9507489390	sushilapuri224@gmail.com	S.Puri
15.	Sanam M. Uprade	9890230462	upradesanam@gmail.com	Suprade
16.	Sakshi V. Chamate	7709204933	chamate.sakshi24@gmail.com	sakshi
17.	astha A. bhakarwad	9405197842	asthabakarwad@gmail.com	Astha
18.	ojaswini Bhagat	7558367348	ojaswini.bhagat@gmail.com	Ojaswini
19.	Avanti chaptekar	7875173847	avanti1011@gmail.com	Avanti
20.	RUPESH W. WADDE	8329676611	rupeshwadde123@gmail.com	Rupesh
21.	Balraj M. Welda.	9420396682	balrajweldar@gmail.com	Balraj
22.	Prakal Mungde	9834234902	prajwalmungde123@gmail.com	Prakal
23.	Neha A. Waghade	7249895144	nehawaghade16082002@gmail.com	NWaghade
24.	Vanshika C. Yede	7558244609	vanshikayede1@gmail.com	Vanshika
25.	Baniya P. Naik	9370570457	Baniya.naik51@gmail.com	B.Naik
26.	Vaishnavi R. Chandekar	7249882964	vaishnavichandekar@gmail.com	V.Chandekar

Signature of:

Programme Incharge

IQAC COORDINATOR
INTERNAL QUALITY ASSURANCE CELL
DHARAMPETH, M. P. DEO MEMORIAL &
SCIENCE COLLEGE, NAGPUR

Principal
Dharampeth M.P. Deo Memorial
Science College, Nagpur.



DHARAMPETH M. P. DEO MEMORIAL SCIENCE COLLEGE, NAGPUR
INTERNAL QUALITY ASSURANCE CELL (IQAC)

Activity Report

Date: 26-12-2022

Name of Organizing Department or Committee: Alumni Committee
Name of the activity: Alumni Sports Meet 2022
Suggested CRITERION point if any: Criteria-V
Date of Activity: December 25, 2022
Place of Activity: Sports Ground
Name of Guest Speaker/s or Judge/s or Chief Guest/s if any: NA
Title of the Activity: Alumni Sports Meet 2022
Number of Participants: 45+
Name of the Teacher In-charge / Convener: Lt. Dr. P. W. Ambekar
Names of other Committee Members / Staff: Dr. Sunil Rathod, Dr. Rahul Kalode, Dr. Kishor Urkudkar, Mr. Roshan Thakare, Mr. Dilip Choudhari, Mr. Shriram Paunikar, Mr. Aniket Sirswan, Mr. Prabhakar etc.

OUTCOME of the Activity with respect to mission vision of the institute and or academics:

The meet was convened on the Sunday so that most of the ex-students/ alumni shall be available. On the day of the alumni sports meet i.e. Sunday the 25th December 2022, at around 8:30 am most of the staff members, including sports teacher, alumni, the Vice-president of the Alumni Executive Body along with Principal and the In-charge of the Committee were present on the venue. Lt. Dr. Prashant Ambekar introduced Principal, Dr. Akhilesh Peshwe. Dr. Peshwe then introduced the Vice-President of the Alumni Dr. Prashant Agrawal and a senior member of the alumni, Dr. Muktibodh, and then everyone has introduced themselves. The current students were also introduced with the alumni. The sports teacher then made two teams of the members and matches were played among them. Parallel matches of Badminton were also played among the alumni members. It was really an enjoyable day for all of us. Mean while Breakfast and Coffee were served. The winner team was provided with a trophy at the hands of the convener, Lt. Dr. Prashant Ambekar.

Activity with newspaper coverage if any: No

Activity data save in PC of: Lt. Dr. P. W. Ambekar



Prof. Pitambar Humane
IQAC Coordinator

CO ORDINATOR
INTERNAL QUALITY ASSURANCE CELL
DHARAMPETH, M. P. DEO MEMORIAL &
SCIENCE COLLEGE, NAGPUR

(Lt. Dr. Prashant Ambekar)
Name & Signature of Teacher In-charge

Dr. Akhilesh Peshwe
Principal
PRINCIPAL
Dharampeth, M. P. Deo Memorial
Science College, Nagpur.



DHARAMPETH M. P. DEO MEMORIAL SCIENCE COLLEGE, NAGPUR

Activity Title: Alumni Sport Meet

Date: 25-12-2022

Sr No	Name of the Alumni	Passing Year	Email-ID	Mobile #	Signature
1	Sheetal Jha	2006	sheetalpja@gmail.com	9820012941	
2	Dr. Rashmi Agrawal	1996	pragnya@gmail.com	9422366811	
3	Rushi Pinge	2007	rushi.pinge1@gmail.com	974223677	
4	Dr. Anur Mukhtibadi	1976	anukhizero@yahoo.com	9850411871	
5	Pranali Jha	2006	pranjinaljha@gmail.com	9822416898	
6	Deedatta S. Sovani	2007	deedatta.sovani1985@gmail.com	9730752350	
7			Jmail.com		
8	Vishal Agre	2009	V.S.Agre@gmail.com	9730891509	
9	Prasad Granthi	2022	prasadgranthi@gmail.com	8199318584	
10	Anandesh Chandol	2022	anandeshchandol@gmail.com	9325184623	
11	Aniket S. Gedam	2022	aniketgedam04@gmail.com	9822625296	
12	Anirudha P. Ashikar	2020	anirudhaashikar@gmail.com	9607105352	
13	GAURAV TANKSAL	2006	Gaurav.Tanksal@gmail.com	9960032020	
14	Dinesh Warkade	2006	dworkade@gmail.com	8828172184	
15	Manoj Landge	2007	ManojLandge15@gmail.com	986570483	
16	Siddhanta Kambh	2008	Siddhanta-kambh@rediffmail.com	9977766567	
17	Dhanraj Singh	2009	dhansingh123@gmail.com	881742744	
18	Dhanraj Lankar	2007	Dhanraj.Lankar@yahoo.in	8149001556	
19	Govinda Lakhotiya	2007	Lakhotiya.govinda@gmail.com	9579195076	

CORUPPER

13/11/2022

DEPARTMENT OF SCIENCE
DHARAMPETH M. P. DEO MEMORIAL
SCIENCE COLLEGE, NAGPUR



DHARAMPETH M. P. DEO MEMORIAL SCIENCE COLLEGE, NAGPUR

Activity Title: Alumni Sport Meet

Date: 25-12-2022

Sl No	Name of the Alumni	Passing Year	Email-ID	Mobile #	Signature
20.	Nikhil Somkude	2008	nikhilsomkude@gmail.com	8946430590	
21.	Priyanka Jeshi Ganesh	2009	jeshisopriyanka@gmail.com	9890211585	
22.	Arvindash Wadhade	2009	Arvindashwadhade003@gmail.com	8956847122	
23.	Dr. Mrs. Ubale	1983	seema k s u @ g mail com	9420246680	
24.	Vijayal Jha	2013	VijayalKumar163jha@gmail.com	8466766676	
25.					
26.					
27.					
28.					
29.					
30.					
31.					
32.					
33.					
34.					
35.					
36.					
37.					
38.					

Convener

(L. Dr. Prashant Ambekar)

Dharampeth M. P. Deo Memorial
Science College, Nagpur



DHARAMPETH M. P. DEO MEMORIAL SCIENCE COLLEGE, NAGPUR

Date: 25-12-2022

Activity Title: Alumni Sport Meet

Sr. No	Name of the Alumni / party / post	Passing Year	Email-ID	Mobile #	Signature
96.	Vedant K. Badhiye		vedantbadhiye46@gmail.com	9604693411	
97.	Bhamesh S. Badhiye		Bhameshbadhiye19@gmail.com	9715262138	
98.	Aditya Kumar Singh		adityasingh288180@gmail.com	7350543901	A.K.S.
99.	Arijit Kumar Sharma		arij70105karma@gmail.com	7020103398	Arjij
100.	Deepak. D. Dhakne		DDhakne9786@gmail.com	8459167742	
101.	Sulhanstha R. Wadga		Sulhansthaulstha112@gmail.com	7023429177	
102.	Laxesh Z. Rathod		Laxeshrathod1234@gmail.com	9393028834	
103.	Tajod Rawade		tajodrawade786@gmail.com	9790027056	
104.	Tushant Dan Dhare		Tushantdanadhare29@gmail.com	9422489475	
105.	Sulbham Kanojiya		KanojiyaSulbham815@gmail.com	8237523566	
106.	Akhilshree Deshbhambare		Akhilshreedeshbhambare205@gmail.com	8208302902	
107.	Yadnyik Dhage		ysdhdage0106@gmail.com	8623062678	
108.	Nikhil R. Datar		datarn6361@gmail.com	3022680159	
109.	Ashika G. Datar		datarnashika@gmail.com	4028915776	
110.	Dinesh I. Parlati		Parlati.dinesh51@gmail.com	9623323676	
111.	Akash A. Sikelan		Sikelanakash15@gmail.com	9175472017	
112.	Kishor S. Wkuddekar		kishorwuddekar@gmail.com	9891811420	
113.	Mr. R.K. Thakre		rthakre57@gmail.com	8983881335	
114.	Dr. R.B. Lanjewar		rbk.lanjewar@adilshahi.com	9881021205	

Convenor

(Lt. Dr. Prashant Ambekar)

Principal
(Dr. A.P. Prasad)
Dharampeth M. P. Deo Memorial
Science College, Nagpur



DHARAMPETH M. P. DEO MEMORIAL SCIENCE COLLEGE, NAGPUR
INTERNAL QUALITY ASSURANCE CELL (IQAC)

Activity Report

Date: 31/12/2022

Name of Organizing Department or Committee: IQAC Initiative

Name of the activity: Interactive Session with Bank of Maharashtra

Suggested CRITERION point if any: VI

Date of Activity: 27/12/2022

Place of Activity: College Conference Room

Name of Guest Speaker/s or Judge/s or Chief Guest/s if any: Shri. Akshya Kumar Linka, Branch Manager, Bank of Maharashtra, Mrs. Pranali Admane Gaikwad, Manipal Cigna Pro-Health Group

Title of the Activity: Interaction with Bank of Maharashtra Authorities: A Welfare Measure

Number of Participants: 10

Name of the Teacher In-charge / Convener: Mrs. Ruma Kapre

Names of other Committee Members / Staff: NA

OUTCOME of the Activity with respect to mission vision of the institute and or academics:

To take initiative as a social welfare measure for teaching and non-teaching staff of the college, a meeting cum interactive session was organized with Bank of Maharashtra Authorities to discuss different schemes like insurance policies, Medilaim as well as different loan facilities with the Bank. The authorities of Bank of Maharashtra Mr. Akshay Kumar Linka provided the detailed information about facilities for the employee with salary account, like general group insurance and general group medilaim. A scheme for Medilaim was proposed by Manipal Cigna Pro-Health Group, a health insurance provider and associated group of Bank of Maharashtra. Mrs. Pranali Admane Gaikwad provided complete insurance policies details to the staff members present during the interaction.

Activity with newspaper coverage if any: NA

Activity data save in PC of: Mrs. Ruma Kapre



Prof. Pitambar Humane
IQAC Coordinator

CO ORDINATOR
INTERNAL QUALITY ASSURANCE CELL
DHARAMPETH M. P. DEO MEMORIAL &
SCIENCE COLLEGE, NAGPUR

Mrs. Ruma Kapre
Name & Signature of Teacher In-charge

Dr. Akhlesh Peshwe
Principal

Principal
Dharampeth M.P. Deo Memorial
Science College, Nagpur.



DHARAMPETH M. P. DEO MEMORIAL SCIENCE COLLEGE,
North Ambazari Road, Near Ambazari Lake, Nagpur- 440033

DATA VALIDATION & VERIFICATION (DVV)

Name of the Programme : Interactive Session With Bank of Maharashtra Authorities
Date of the Programme : 27/12/2022
Name of Chief Guest if any : Shri Akshya Kumar Linka, Branch Manager, BOM
Name of Guest Speaker if any : Mrs. Pranali Admane Gaikwad, Manipal Cigna Pro-Health Group

Sr. No.	Name of the Participant	Mobile Number	E-mail Id	Signature
1.	Prof. P.T. HUMANE	9970468635	gaganprasaad@rediffmail.com	
2.	Dr/Mrs V.R. Kathake	9422880665	vidyakathake15@gmail.com	
3.	Prof. V.V. Rangari	9890364522	ranganivarsha1@gmail.com	
4.	Dr. S.A. Natale	989033639	snehaj.natale@gmail.com	
5.	Mrs. R.R. Kapre	9423110272	ruma.kapre@yahoo.co.in	
6.	Dr. K.H. Mi. Pitunkar	9850301939	kmpitunkar@gmail.com	
7.	Dr. Mrs S.A. Deshpande	9860042850	shrawantideshpande2003@gmail.com	
8.	U. Dr P.W. Ambekar	7776899618	pacific0701@gmail.com	

Signature of:

Programme In-charge

Mrs. Ruma Kapre

IQAC Coordinator

CO ORDINATOR
INTERNAL QUALITY ASSURANCE CELL
DHARAMPETH M. P. DEO MEMORIAL
SCIENCE COLLEGE, NAGPUR

Principal

Principal
Dharampeth M.P. Deo Memorial
Science College, Nagpur.



D. P. DEO MEMORIAL SCIENCE COLLEGE, NAGPUR
INTERNAL QUALITY ASSURANCE CELL (IQAC)

Activity Report

Date: 31/12/2022

Name of Organizing Department or Committee: Microbiology Department

Name of the activity: Alumni interaction

Suggested CRITERION point if any: Criterion II and V

Date of Activity: 31/12/2022

Place of Activity: Microbiology Department

Name of Guest Speaker/s or Judge/s or Chief Guest/s if any: Guest Speaker- Mr. Ashutosh Patil

Title of the Activity: Interaction of Alumnus with Sem I and III students on Scope of Microbiology in Food Industries.

Number of Participants: 11

Name of the Teacher In-charge / Convener: Dr. Vidya R. Kathoke

Names of other Committee Members / Staff:

OUTCOME of the Activity with respect to mission vision of the institute and or academics:

The students come to know about Scope of Microbiology in Food Industrial area. Such Interactions help in creating their interest in the core subject microbiology, in India and abroad through their guidance.



Dr. Kathoke

Dr. Vidya R. Kathoke

Name & Signature of Teacher In-charge

Prof. Pitambar Humane

Prof. Pitambar Humane
IQAC Coordinator

Dr. Akhilesh Peshwe
Principal



DHARAMPETH M. P. DEO MEMORIAL SCIENCE COLLEGE,
North Ambazari Road, Near Ambazari Lake, Nagpur- 440033

DATA VALIDATION & VERIFICATION (DVV)

Name of the Programme : _____
 Date of the Programme : _____
 Name of Chief Guest if any : _____
 Name of Guest Speaker if any : _____

Sr. No.	Name of the Participant	Mobile Number	E-mail Id	Signature
1.	Chiranjiv S. Gajbhiye	8329412694	cgajbhiye17@gmail.com	<i>Gajbhiye</i>
2.	Khushi K. Rewade	9588445994	khushirewade@gmail.com	<i>Rewade</i>
3.	Chametal K. Waghmare	7796160894	waghmaremitara@gmail.com	<i>Chametal</i>
4.	Meenal A. Chaudhary	9529014604	meenalkhondhary@gmail.com	<i>Chaudhary</i>
5.	Aakansha Y. Mairal	8010923662	aakuyogi@gmail.com	<i>Ayrawar</i>
6.	Rohy K. Nanjari	9926019219	kishnananjari1294@gmail.com	<i>Rohy</i>
7.	Riya A. Singh	9595649881	riyas2307@gmail.com	<i>R Singh</i>
8.	Shreya A. Jha	8983236002	Sangeetya0303@gmail.com	<i>Jha</i>
9.	Crushi R. Bhojare	8668335876	crushibhojare31@gmail.com	<i>Crushi</i>
10.	Krutika S. Pokale	8021533341	pokalekrutika@gmail.com	<i>Krutika</i>

Signature of: 11) Dhanashri Neware 9369909913 dhanashrineware@gmail.com *Neware*

W. K. Kulkarni
Programme in-charge

IQAC Coordinator

Principal
Principal
 08/08/2023 11:00 AM



DHARAMPETH M. P. DEO MEMORIAL SCIENCE COLLEGE,
North Ambazari Road, Near Ambazari Lake, Nagpur- 440033

DATA VALIDATION & VERIFICATION (DVV)

Name of the Programme : Alumnus Interaction with students
Date of the Programme : 31 December 2022
Name of Chief Guest if any : Mr. Ashutosh Patil
Name of Guest Speaker if any : Mr. Ashutosh Patil

Sr. No.	Name of the Participant	Mobile Number	E-mail Id	Signature	
1	Vaishnavi Gadge	9022976449	gadgewaishnavi@gmail.com		SEM 3
2	Vedant Baxy	8530465796	vedantbaxy2002@gmail.com		SEM 3
3	Gaangi Hadge	7972076671	gaangihadge@gmail.com		SEM 3
4	Harsh Kodape	9604677672	harshkodape003@gmail.com		SEM 3
5	Pranjal Bhojra	8010434634	Pranjalh738@gmail.com		SEM 3
6	Meenal A. Chaudhari	9528014604	meenalkhulbani@gmail.com		SEM-I
7	Chanchal K. Waghware	7796016894	waghwaremitara@gmail.com		

Signature of:

Programme In-charge

IQAC Coordinator

Principal



Activity Report

Date: 2, Jan 2023

Name of Organizing Department or Committee: BOTANY DEPARTMENT

Name of the activity: Study of Mushroom Family

Suggested CRITERION point if any: CRITERION-1

Date of Activity: 2nd Jan., 2023

Place of Activity: DHARAMPETH M.P. DEO MEMORIAL SCIENCE COLLEGE

Name of Guest Speaker/s or Judge/s or Chief Guest/s if any: Prof. Pitambar Humane

Title of the Activity: To study the members of mushroom family in and around college campus and residence.

Number of Participants: 28

Name of the Teacher In-charge / Convener: Mr. Amol Pimpalshende

Names of other Committee Members / Staff: Dr. Chandrakumar Patle, Dr. Mrs. Sweta Rai & Mrs. Dipali Nikure

OUTCOME of the Activity with respect to mission vision of the institute and or academics: Students understood the natural habitat of the flora of Mushroom as well environmental condition in which they grown. Various types of Mushroom species were observed by the students from College campus and they also gain information, how to collected and identify Mushroom from others fungus members. Some common Mushroom species were collected and described by students with the help of Teachers and online sources. The *Auricularia auricula-judae* (edible Judas ear mushroom) and *Schizophyllum commune* Mushroom belonged to Auriculariaceae and Schizophyllaceae, were collected and identify by students. The interest and concentration of the students increases in the subject due to collection and identify the Mushroom members in and around college campus.

Activity with newspaper coverage if any: NA

Activity data save in PC of: Mr. Amol Pimapalshende's Laptop



Agale (AMM)-M.Pimpalshinde

Name & Signature of Teacher In-charge

Prof. Pitambar Humane
IQAC Coordinator

CO ORDINATOR
INTERNAL QUALITY ASSURANCE CELL
DHARAMPETH, M. P. DEO MEMORIAL &
SCIENCE COLLEGE, NAGPUR

Dr. Akhilesh Peshwe
Principal

Principal
Dharampeth M.P. Deo Memorial
Science College, Nagpur.



DHARAMPETH M. P. DEO MEMORIAL SCIENCE COLLEGE,
North Ambazari Road, Near Ambazari Lake, Nagpur- 440033

26/1/23

DATA VALIDATION & VERIFICATION (DVV)

Name of the Programme : To study the members of Mubram Family in and around college
 Date of the Programme : 2.01.23
 Name of Chief Guest if any : _____
 Name of Guest Speaker if any : _____

CAMPUS OR RESIDENCES.

Sr. No.	Name of the Participant	Mobile Number	E-mail Id	Signature
1.	Ashalesha Khadgi	81820929579	Ashaleshakhadgi@gmail.com	Ashalesha
2.	Abhay Tembhare	8975363145	abhay230102@gmail.com	Abhay
3.	Aparna Mohare	7020649887	aparnamohare@gmail.com	Aparna
4.	Ravindra Khudse	8007198273	khudse.ravindra892@gmail.com	Ravindra
5.	Nitu B. Rai	7058638984	rnitu1413@gmail.com	Nitu
6.	Lucky A Vishwakarma	9579660186	lvishwakarma240@gmail.com	Lucky Vishwakarma
7.	Khushi S. Bhavti	9604367896	2003khushibhavti@gmail.com	Khushi
8.	Khushi D. Bhasad	7637249032	khushidhasad31@gmail.com	Khushi
9.	Nikita Das	8448297880	Nikitadas970@gmail.com	Nikita
10.	Hussain Hussain	7066411418	hussainhussain@gmail.com	Hussain

Signature of: 11) Peyush T. Paul

M. P.
IQAC Coordinator

Principal
Principal

Asaka
Programme In-charge

CO-ORDINATOR
INTERNAL QUALITY ASSURANCE CELL
DHARAMPETH, M. P. DEO MEMORIAL &
SCIENCE COLLEGE, NAGPUR

Dharampeth M.P. Deo Memorial
Science College, Nagpur.



DHARAMPETH M. P. DEO MEMORIAL SCIENCE COLLEGE,
North Ambazari Road, Near Ambazari Lake, Nagpur- 440033

DATA VALIDATION & VERIFICATION (DVV)

12	Shital G. Bankar	7758055139	shitalbankar22@gmail.com	SGBankar
13	Pallavi Boskar	9373187246	PallaviBoskar12@gmail.com	Pallavi :-
14	Pratiksha Naughere	8623033760	Pratiksha99@gmail.com	PS. Naughere
15	Sagar Bawane	9975460979	Sagarbawane37@gmail.com	SBawane
16	Kalyani C. Shahare	9307646378	Pratishkalyani J. @gmail.com	Kalyani
17	Devesh Lonjadge	839051617	Deveshlonjadge@gmail.com	Devesh
18	Jaganti Rawat	9265818046	Jagantiagrawat51@gmail.com	JRawat.
19	Subbu Mishra	9860436418	Subbunishra@gmail.com	Subbu
20	Shikha Yadav	7263881320	Shikha.Yadav@gmail.com	S. J. Yadav
21	sakshi Pakhale	9311412192	sakshipakhale22@gmail.com	Pakhale
22	Shruti Magram	8308657972	shrutimagram01@gmail.com	Shruti
23	sakshi Sambhule	8329053523	sakshisambhule@gmail.com	Sambhule P
24	Yashvanti P. Chande	9765009925	yashvanti@gmail.com	Y.P.C.
25	Riya R. Kulkarni	7420356528	riyaskulkarni12@gmail.com	Riya
26	Shreyas B. Bagde	8669883639	bagdeshreyas18@gmail.com	Sbagde.

Signature of:

Programme In-charge

IQAC Coordinator
COORDINATOR
INTERNAL QUALITY ASSURANCE CELL
DHARAMPETH, M. P. DEO MEMORIAL &
SCIENCE COLLEGE, NAGPUR

Principal
Principal
Dharampeth M.P. Deo Memorial
Science College, Nagpur.



Activity Report

Date: 2, Jan 2023

Name of Organizing Department or Committee: BOTANY DEPARTMENT

Name of the activity: Study of Plant diseases

Suggested CRITERION point if any: CRITERION-1

Date of Activity: 2nd Jan., 2023

Place of Activity: DHARAMPETH M.P. DEO MEMORIAL SCIENCE COLLEGE

Name of Guest Speaker/s or Judge/s or Chief Guest/s if any: Prof. Pitambar Humane

Title of the Activity: To study the common plant diseases found in and around college campus and residence.

Number of Participants: 27

Name of the Teacher In-charge / Convener: Mr. Amol Pimpalshende

Names of other Committee Members / Staff: Dr. Chandrakumar Patle, Dr. Mrs. Sweta Rai & Mrs. Dipali Nikure

OUTCOME of the Activity with respect to mission vision of the institute and or academics: Students understood the various types of diseases occur on plants found in college campus and residence. Students understood fungal, viral, bacterial pathogens which were infected the plants. Students also understood the difference between the infected and normal plants. Students were gain knowledge about symptoms of infected plants such as Citrus canker, curly leaf of Papaya, little leaf of brinjal, powdery mildew etc.

The interest and concentration of the students increases in the subject due to Study of plant diseases in and around college campus.

Activity with newspaper coverage if any: NA

Activity data save in PC of: Mr. Amol Pimapolshende's Laptop



Prof. Pitambar Humane
IQAC Coordinator

CO ORDINATOR
INTERNAL QUALITY ASSURANCE CELL
DHARAMPETH, M. P. DEO MEMORIAL &
SCIENCE COLLEGE, NAGPUR

Aside (Anil M. Pimpalkhori)
Name & Signature of Teacher In-charge

Dr. Akhilesh Peshwe
Principal

Principal
Dharampeth M.P. Deo Memorial
Science College, Nagpur.



DHARAMPETH M. P. DEO MEMORIAL SCIENCE COLLEGE,
North Ambazari Road, Near Ambazari Lake, Nagpur- 440033

DATA VALIDATION & VERIFICATION (DVV)

Name of the Programme : To study common plant diseases found in and around college campus or residence

Date of the Programme : 2.09.23

Name of Chief Guest if any : _____

Name of Guest Speaker if any : _____

Sr. No.	Name of the Participant	Mobile Number	E-mail Id	Signature
1	Ravindra M. Khudse	9007198273	khudse.m.vh@vsnl.com	
2)	Nitu. B. Rai	7658638984	nitu149@gmail.com	
3)	Lucky A Vishwakarma	9579660186	lvishwakarma@gmail.com	
4)	Khushi S. Bharti	9604367891	khushibharti@gmail.com	
5)	Khushi D. Prasad	9637249032	khushi.prasad@gmail.com	
6)	Nikita Das	9637249087	Nikitadk.s@gmail.com	
7)	Aarjya S. Hussain	7066411418	hussainarjya@gmail.com	
8)	Aparna Mahare	7020649887	aparnamahare@gmail.com	
9)	Ayana Hoke	9011681628	ayyanamala13@gmail.com	
10)	Yogita Denge	7058437240	Yogitadenge@gmail.com	

Signature of: Ghanshree Dhanne

Programme In-charge

IQAC Coordinator
COORDINATOR
INTERNAL QUALITY ASSURANCE CELL
DHARAMPETH, M. P. DEO MEMORIAL &
SCIENCE COLLEGE, NAGPUR

Principal
Dharampeth M.P. Deo Memorial
Science College, Nagpur.



DHARAMPETH M. P. DEO MEMORIAL SCIENCE COLLEGE,
North Ambazari Road, Near Ambazari Lake, Nagpur- 440033

DATA VALIDATION & VERIFICATION (DVV)

12	Rishikesh Rajesh Kokate.	9037554918.	kopalefishikesh@gmail.com	Rishikesh
13	Yogita R. Denge	7058437240	yogitadenge@gmail.com	Yogita
14	Amisha D. Ankate	7666559171	ankateamisha700@gmail.com	Amisha
15	Sejal D. Kothre	8483045085	kothresejal04@gmail.com	Sejal
16	Khushi Prasad	96372169032	khushiprasad31@gmail.com	Khushi
17	Nikita Das	9637249037	Nikitadas307	Nikita
18	Ananya S. Hussain	7068111418	hussainananya	Ananya
19	Riya Raybhanu	8600256951	riyareybhane@gmail.com	Riya
20	Aparna Mohare	7020649887	opannamohare@gmail.com	Aparna
21	Aarti Kharole	9579715628	aartikharole@gmail.com	Aarti
22	Ashwini Lanjewan	968911754	lanjewanashwini77@gmail.com	Ashwini
23	Aanya Dhole	9011681628	anyamamata131@gmail.com	Aanya
24	Anjali Thakre	7060554821	thakreanjali381@gmail.com	Anjali
25	Anshul Kironpure	9284067169	anshulkironpure650@gmail.com	Anshul
26	Nisha Pandey	8605231390	anishka8605331390@gmail.com	Nisha
27	Yashna Pandey	9156035297	pandeyyashna@gmail.com	Yashna

Signature of:

Programme In-charge

IQAC Coordinator
CO ORDINATOR
INTERNAL QUALITY ASSURANCE CELL
DHARAMPETH, M. P. DEO MEMORIAL &
SCIENCE COLLEGE, NAGPUR

Principal
Principal
Dharampeth M.P. Deo Memorial
Science College, Nagpur.



DHARAMPETH M. P. DEO MEMORIAL SCIENCE COLLEGE, NAGPUR
INTERNAL QUALITY ASSURANCE CELL (IQAC)

Activity Report

Date: 02/01/2023

Name of Organizing Department or Committee: Microbiology Department

Name of the activity: Alumnus Felicitation and Guest Lecture

Criterion: II and V

Date of Activity: 2nd Jan 2023

Place of Activity: A.P.J. Abdul Kalam Hall

Name of Guest Speaker/s or Judge/s or Chief Guest/s if any: Guest Speaker- Mr. Mrunal Wagh

Title of the Activity: Journey from Dharampeth Science College to VIT Vellore Institute, of Alumnus Mr. Mrunal Wagh .

Number of Participants: 26

Name of the Teacher In-charge / Convener: Dr. Vidya R. Kathoke

Names of other Committee Members / Staff: Dr. Vaishali Pimple

OUTCOME of the Activity with respect to mission vision of the institute and or academics:

Students understood about the importance of hard work as well as perseverance. They get knowledge about journey of Alumnus in achieving young research award of India at the age of 27, as well as various career opportunities in the field of Microbiology. They developed confidence and get motivation to peruse career in Microbiology and allied areas, abroad through their guidance.



Prof. Pitambar Humane
IQAC Coordinator

Dr. Vidya R. Kathoke
Name & Signature of Teacher In-charge

Dr. Akhilesh Peshwe
Principal



Dharampeth M.P. Deo Memorial science College, Nagpur
Academic Session: 2022-2023
DEPARTMENT OF MICROBIOLOGY

Date:01/01/2023

NOTICE

All dear student Happy New year and good morning tomorrow our alumnus studying at Vellore institute is coming to our college he is just now awarded with best Young Scientist Award of India at the age of 27, he wishes to meet you all and want to guide you, so all of you come to college tomorrow at 2.00 pm in Abdul kalam hall.

Venue: APJ Abdul Kalam Hall
Date: 2nd January 2023
Time: 2.00 pm

Alkathoke
Head

Department of Microbiology

Dharampeth M.P. Deo Memorial
Science College,
Nagpur



DMPDSVM

MICROBIOLOGY DEPARTMENT ASSOCIATION

MICROBLISS

FELICITATION & GUEST LECTURE



**MRUNAL S.
WAGH**

ALUMNUS OF
MICROBIOLOGY
DEPARTMENT

DR. MRS. VIDYA KATHOKE
CONVENER

DR. AKHILESH PESHWE
CHIEF GUEST



02 JAN, 2023

MONDAY 2:00PM

APJ ABDUL KALAM HALL

you all are invited for the felicitation
program followed by the guest
lecture on "My Journey from
Dharampeth Science College to
VELLORE Institute "



DHARAMPETH M. P. DEO MEMORIAL SCIENCE COLLEGE,
North Ambazari Road, Near Ambazari Lake, Nagpur- 440033

DATA VALIDATION & VERIFICATION (DVV)

Name of the Programme : Felicitation of Guest Lecture of Annual. S. Wagh
Date of the Programme : 02/01/23
Name of Chief Guest if any : Dr. Anurag S. Wagh
Name of Guest Speaker if any : _____

Sr. No.	Name of the Participant	Mobile Number	E-mail Id	Signature
1	Carini K. Pali	7758058514	carini.k.pali@gmail.com	
2	Anjali R. Pali	7498102109	pali.anjali44@gmail.com	
3	Anushri S. Wale	8530778433	anushriwale2002@gmail.com	
4	Aishwarya A. Joshi	7498328662	aishwaryajoshi2002@gmail.com	
5	Tshika S. Thakre	8010907069	tshikathakre90@gmail.com	
6	Nandini S. Hadge	9310301679	nandinihadge17@gmail.com	
7	Bhargavi A. Sambare	9709403806	bhargavisambare2002@gmail.com	
8	Madhura U. Bhondure	8767484914	madhura.bhondure@gmail.com	
9	Ayushi Shukla	9373668043	ayushishukla2002@gmail.com	
10	Samirsha Choudhary	7517090406	choudharysamirsha2002@gmail.com	

Signature of:

Programme In-charge

IQAC Coordinator



DHARAMPETH M. P. DEO MEMORIAL SCIENCE COLLEGE,
North Ambazari Road, Near Ambazari Lake, Nagpur- 440033

DATA VALIDATION & VERIFICATION (DWV)

11.	Samiksha N. Kuntekar	9145258158	samikshakuntekar@gmail.com	<u>Samiksha</u>
12.	Shruti M. Pawar	9521988707	shrutipawar2001@gmail.com	<u>Shruti</u>
13.	Rinam C. Wankhede	3010866529	wankhederinamot@gmail.com	<u>Rinam</u>
14.	Suman. A. Singh.	7249465307	misssumansingh@gmail.com	<u>Suman</u>
15.	Sanskriti S. Panchbhare	7447613185	sanskritipanchbhare@gmail.com	<u>Sanskriti</u>
16.	Shreyansh Naikwar	7447844189	shreyanshnaikwar7@gmail.com	<u>Shreyansh</u>
17.	Dally K. Najari	9326013213	Kalishanajari12345@gmail.com	<u>Dally</u>
18.	Aakansha Y. mairal	8010923662	aakanyogi2004@gmail.com	<u>Aakansha</u>
19.	Virek R. Wadhvani	8956482581	Virek.wadhvani89@gmail.com	<u>Virek</u>
20.	Astha A. Sakharwale	9405197842	asthasakharwale@gmail.com	<u>Astha</u>
21.	Avanti A. Chaphekar	7875173847	avanti1011@gmail.com	<u>Avanti</u>
22.	Pranali - Y. Chavhare	9699654562	pranalichavhare6@gmail.com	<u>Pranali</u>
23.	Pratiksha - M. Meshram	8459870338	mehrampratiksha@gmail.com	<u>Pratiksha</u>
24.	Dhanabai Newar	9359307913	dhanabainewar123@gmail.com	<u>Dhanabai</u>
25.	Gauri Bhoyar	9668335876	gauribhoyar3@gmail.com	<u>Gauri</u>
26.	Aparna Mohare	7020649887	aparnamohare23@gmail.com	<u>Aparna</u>

Signature of:

Katheke
Programme In-charge

[Signature]
IQAC Coordinator

Principal
Dharampeth M. P. Deo Memorial
Science College



**DHARAMPETH M. P. DEO MEMORIAL SCIENCE COLLEGE, NAGPUR
INTERNAL QUALITY ASSURANCE CELL (IQAC)**

Activity Report

Name of Organizing Department or Committee: Microbiology Department

Name of the activity: Students Visit

Suggested CRITERION point if any: Criterion II

Date of Activity: 5th Jan 2023

Place of Activity: New RTM University Campus, Nagpur.

Name of Guest Speaker/s or Judge/s or Chief Guest/s if any: Guest Speaker - Nil

Title of the Activity: Students Visit to Indian Science Congress Exhibition

Number of Participants: 19

Name of the Teacher In-charge / Convener: Dr. Mrs Vaishali Pimple

Names of other Committee Members: Nil

OUTCOME of the Activity with respect to mission vision of the institute and or academics:

Students visited the expo and got an opportunity to study and observe e advancement in various research areas in the field of Science & Technology

Activity with newspaper coverage any:

https://m.facebook.com/story.php?story_fbid=pfbid05QkVCYu5x9RLv1mY8tPtQu8L3hYfEUs9xTiyWfgyQm4D5f6nwvt2GKMv4YpimXiSI&id=100064142527382&mibextid=Nif5oz



Prof. Pitambar Humane
IQAC Coordinator

Dr. Mrs Vaishali Pimple
Name & Signature of Teacher In-charge

Dr. Akhilesh Peshwe
Principal

Principal
Dharampeth M. P. Deo Memorial
Science College, Nagpur



DHARAMPETH M. P. DEO MEMORIAL SCIENCE COLLEGE,
North Ambazari Road, Near Ambazari Lake, Nagpur- 440033

DATA VALIDATION & VERIFICATION (DVV)

Name of the Programme : STUDENTS VISIT TO INDIAN SCIENCE CONGRESS
Date of the Programme : 5th Jan 2023
Name of Chief Guest if any : _____
Name of Guest Speaker if any : _____

Sr. No.	Name of the Participant	Mobile Number	E-mail Id	Signature
	Madhura D. Khoswe	8767484914	madhura@khoswe.com	Madhura
	Ayushi Shukla	9373668043	ayushishukla3812008@gmail.com	Ayushi
	Rinam C Wankhede	8010966529	wankhede@rinam.com	Rinam
	Shreyansh S. Naikwar	7447844189	shreyanshnaikwar7@gmail.com	Shreyansh
	Adesh Wankar	7512431162	adeshwankar000@gmail.com	A. Wankar
	Shamvi L. Umare	9280249534	shamvi@umare.com	Shamvi
	Pranali Y. Chavhan	9699654562	Pranali@chavhan.com	Pranali
	Aakumbha Y. Maitra	8010923662	aakumbha@yogimaitra.com	Aakumbha
	Billy K. Manjari	9326013213	manjari@billy.com	Billy

Signature of:

Programme In-charge

IQAC Coordinator

Principal
Dharampeth M. P. Deo Memorial
Science College, Nagpur



DHARAMPETH M. P. DEO MEMORIAL SCIENCE COLLEGE,
North Ambazari Road, Near Ambazari Lake, Nagpur- 440053

DATA VALIDATION & VERIFICATION (DWV)

1	Ravindra Chaudse	8007198273	khastirravindan892@gmail.com	Ravi
2	Nitesh Rai	7058628584	snihul114@gmail.com	Nitesh
3	Akya Dhake	901681628	ayyanaakya1331@gmail.com	Akya
4	Aparna mahare	7020649887	aparnamahare27@gmail.com	Aparna
5	Yogita Denge	7058497240	yogitadenge@gmail.com	Yogita
6	Graavi Bhatnagar	8668335876	gravybhatnagar34@gmail.com	Graavi
7	Dhanashri Neware	9259909913	dhanashrineware18@gmail.com	Dhanashri
8	Anagha Borkar	918538614	anaghaborkar19@gmail.com	Anagha
9	Khushi Rewade	9588445996	khushirewade@gmail.com	Rewade
10	Chiranjiv S. Gaikhiye	8329412692	gaikhiye17@gmail.com	Gaikhiye

Signature of:

Programme In-charge

IQAC Coordinator



Principal
Dharampeth M. P. Deo Memorial
Science College, Nagpur



Dharampeth M. P. Deo Memorial Science College, Nagpur
Academic Session: 2022-23

Criteria:

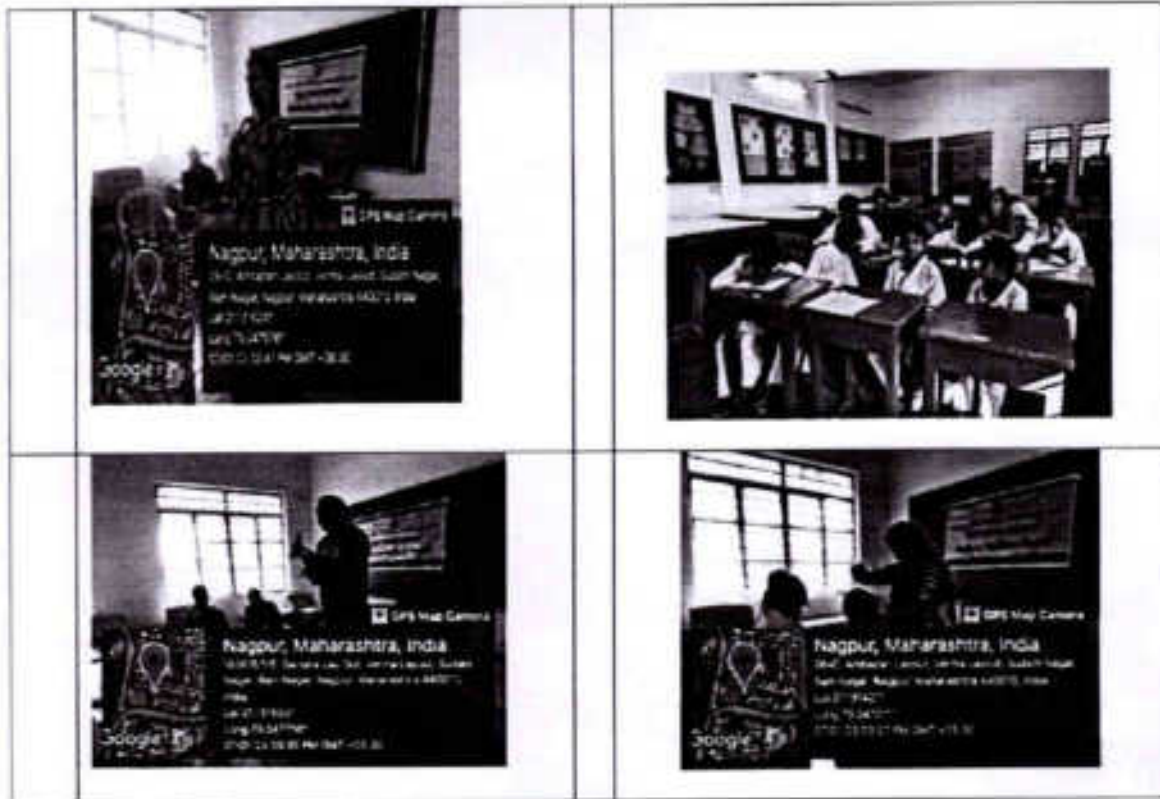
1)	Name of the Department	:	SPORTS AND PHYSICAL EDUCATION
2)	Name of the Activity	:	Nutritional assessment to Karate Players of Dharampeth Science College Sports Academy
3)	Date	:	07.01.2023
4)	Class	:	Dharampeth Science College Sports Academy players
5)	Teacher In charge	:	Dr. Rahul Kalode
6)	Name of Chief Guest	:	Mrs.Pradnya Bagalgote
7)	Topic	:	Nutritional assessment to Karate Players of Dharampeth Science College Sports Academy
8)	Venue	:	Dharampeth M. P. Deo Memorial Science College, Nagpur Home Science Building
9)	Number of students participated	:	15 players
10)	DVV Format	:	NA
11)	Outcome	:	Sports players aware the knowledge of nutrition in sports, importance of nutrition, before, during and after competition for the sports performance. Students gets the benefits of sports nutrition camp and improve their performance
12)	Photos	:	



Gaikwad

Dr. N.P.Gaikwad
IQAC Coordinator

Kalade

Name & Signature of Teacher In-Charge
Dr. Rahul D. Kalade
In-Charge
Deptt. of Physical Education
Dharampeth M.P. Deo Memorial
Science College, Nagpur

Peshwe
Dr. Akhilesh Peshwe
Principal
Dharampeth M.P. Deo Memorial
Science College, Nagpur.



DHARAMPETH M. P. DEO MEMORIAL SCIENCE COLLEGE, NAGPUR
INTERNAL QUALITY ASSURANCE CELL (IQAC)
Activity Report

Date: 30.01.2023

Name of Organizing Department or Committee: Dept. of Home Science

Name of the activity: Nutrition Assessment and Nutrition Education Programme for Karate Club Members

Suggested CRITERION point if any:

Date of Activity: 07.01.2023

Place of Activity: Home Science Department

Name of Guest Speaker/s or Judge/s or Chief Guest/s if any: Dr Akhilesh Peshwe.

Title of the Activity: Nutrition Assessment & Education Programme

Number of Participants: 14

Name of the Teacher In-charge / Convener: Mrs. Pradnya Bagalkote and Dr Manda Walokar

Names of other Committee Members / Staff: Dr Akhilesh Peshwe, Dr Rahul Kalode, and Mrs Manju Deshpande.

OUTCOME of the Activity with respect to mission vision of the institute and or academics:

To develop practical understanding of nutrition assessment techniques and nutrition education practices in young budding athletes of Nagpur City.

Activity with newspaper coverage if any:

Activity data save in PC of: _____

Note: Kindly share geotag photographs separately along with report on iqacdsc2022@gmail.com



Prof. Pitambar Humane

COORDINATOR
INTERNAL QUALITY ASSURANCE CELL
DHARAMPETH, M. P. DEO MEMORIAL &
SCIENCE COLLEGE, NAGPUR

P. Bagalkote
Name & Signature of Teacher In-charge

Dr. Akhilesh Peshwe
Principal
PRINCIPAL
Dharampeth M. P. Deo Memorial
Science College, Nagpur.

Nutrition Assessment & Nutrition Education Programme for Karate Club Members



DHARAMPETH M. P. DEO MEMORIAL SCIENCE COLLEGE,
North Ambazari Road, Near Ambazari Lake, Nagpur - 440033

DATA VALIDATION & VERIFICATION (DVV)

Date :- 7/01/2023

	NAM			
1)	Bhagyashree Ambule	9359139068	ambuleb66@gmail.com	Bambule
2)	Ranali - H Chhangadkar	9309079427	Ranali02yh@gmail.com	Ranali
3)	Pallavi B. Katre	8459277408	PKatre573@gmail.com	Pallavi
4)	Shrushti S. Patkar	7387067403	Shrushtipatkar@gmail.com	Shrushti
5)	Vaichravi Pradhan	4763169560	Pradhanvaishravi55@gmail.com	Vaichravi
6)	Sujata Kaurle	9175451202	SujataKaurle1@gmail.com	Sujata
7)	Avani S. Shenwai	9096507459	avanshawani5@gmail.com	Avani
8)	Ojasvi M. Wankhede	8767699751	wankhedeojasvi@gmail.com	Ojasvi
9)	Kimaya N Kale	8866073792	kimayakale003@gmail.com	Kimaya
10)	Tanee S. Konde	7841984450	kondetomnu33@gmail.com	Tanee
11)	Riya V. More	7350980367	morepriya36@gmail.com	Riya
12)	Mansi - N. Chaudhari	7720088783	chaudharianmans92@gmail.com	Mansi
13)	Priya K. Khawshi	9763617224	priyakhawshi3@gmail.com	Priya
14)	Kuzinu T. Diwe	9280237798	kuzinudive3@gmail.com	Kuzinu

Signature of:

Programme In-charge

COORDINATOR
INTERNAL QUALITY ASSURANCE CELL
DHARAMPETH, M. P. DEO MEMORIAL &
SCIENCE COLLEGE, NAGPUR

Principal
Dharampeth M.P. Deo Memorial
Science College, Nagpur



**DHARAMPETH M. P. DEO MEMORIAL SCIENCE COLLEGE,
NAGPUR
INTERNAL QUALITY ASSURANCE CELL (IQAC)
Activity Report (2022-23)**

Name of Organizing Department or Committee: Home Science Department.

Name of the activity: Students Centric Project

Suggested CRITERION point if any: Criteria II

Date or Period of Activity: 10/01/2023

Place of Activity: Home Science Department

Name of Guest Speaker/s or Judge/s or Chief Guest/s if any:

Title of the Activity: Water Foot Printing – A Pilot Study

Number of Participants: 12

Name of the Mentor/In-charge / Convener: Mrs Pradnya Bagalkote.

Names of other Committee Members / Staff: Mrs Manju Deshpande.

OUTCOME of the Activity with respect to mission vision of the institute and or academics:

Students. - This is a student centric project. Students learnt different types of pulses needs different amount of water for soaking and cooking. Different cooking methods affects weight of pulses and their texture too. Cooking methods also has effect on moisture content of pulses. They can easily measure water foot print of types of pulses. Pulses used for the project are namely redgram, greengram, bengalgram, hoarsegram etc. Cooking time and water conservation noted in this project.

Patent/Copyright/ any IPR related processing if any: Activity with newspaper coverage if any:

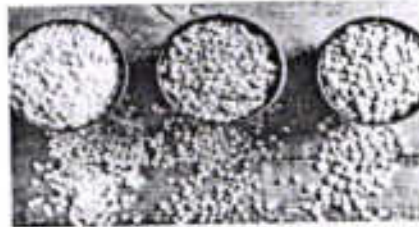

Prof. Pitambar Humane
IQAC Coordinator
COORDINATOR
INTERNAL QUALITY ASSURANCE CELL
DHARAMPETH, M. P. DEO MEMORIAL &
SCIENCE COLLEGE, NAGPUR

Name & Signature of Teacher In-charge

Dr. Abhilesh Peshwe
PRINCIPAL
DHARAMPETH M. P. DEO
MEMORIAL SCIENCE COLLEGE
NAGPUR



DHARAMPETH M. P. DEO MEMORIAL SCIENCE COLLEGE,
North Ambazari Road, Near Ambazari Lake, Nagpur- 440033

DATA VALIDATION & VERIFICATION (DVV)

	name	numbers	e mail ID	sig
1)	Shalnam. T. madavi	9022302785	shalnammadavi5@gmail.com	Shalnam
2)	Archita S. Maske	9975034151	maskearchita@gmail.com	Archita
3)	Prachi. N. Laxkar	8806244419	prachilaxkar15@gmail.com	Prachi
4)	Avani S. Shenuvai	9096507459	shenuvai15@gmail.com	Avani
5)	Tannu S. Korde	7841984450	korde.tannu13@gmail.com	Korde
6)	Kimaya Kale	8866073927	kimoyakale003@gmail.com	Kimaya
7)	Ojaswi Wankhede	8767699751	wankhedeojaswi@gmail.com	Ojaswi
8)	Pranali Ghongadkar	9309079427	Pranali2021@gmail.com	Pranali
9)	Bhagyashree S. Ambule	9359139068	ambule667@gmail.com	Bhagyashree
10)	Vaishnavi. K. Pradhan	9763169560	pradhanvaishnavi153@gmail.com	Vaishnavi
11)	Shrushti. S. Patilkar	7387067403	shrushtipatilkar@gmail.com	Shrushti
12)	Riya. U. Marathe	7350980367	marathe1513@gmail.com	Riya
13)	Deepika Yadav	5790974645	dyadav@gmail.com	Deepika
14)	Pallavi B. Katar	8659277408	Pkatar573@gmail.com	Pallavi

15) Sujata Kaurse

16) Priya Khawshi

Signature of

17) Pragya S. Tiwari

Programme in-charge

18) Kusinu T. Dwe

INTERNAL QUALITY ASSURANCE CELL
DHARAMPETH M. P. DEO MEMORIAL & SCIENCE COLLEGE, NAGPUR

19) Kusinu T. Dwe

20) Kusinu T. Dwe

21) Kusinu T. Dwe

22) Kusinu T. Dwe

23) Kusinu T. Dwe

24) Kusinu T. Dwe

Principal
Dharampeth M.P. Deo Memorial
Science College, Nagpur.



DHARAMPETH M. P. DEO MEMORIAL SCIENCE COLLEGE, NAGPUR
INTERNAL QUALITY ASSURANCE CELL (IQAC)

Activity Report

Date: 23/01/2023

Name of Organizing Department or Committee:

Name of the activity: Debate Competition

Suggested CRITERION point if any: Criteria V

Date of Activity: 13-01-2023

Place of Activity: College

Name of Guest Speaker/s or Judge/s or Chief Guest/s if any: Nil

Title of the Activity: Debate Competition

Number of Participants: 20

Name of the Teacher In-charge / Convener: Dr.Mrs.Shraddha Deshpande

Names of other Committee Members / Staff: Dr.Akhilesh Peshwe (Principal)

OUTCOME of the Activity with respect to mission vision of the institute and or academics:

Debate provides experiences that are conducive to life-changing, cognitive, and presentational skills. It helped the learners to see the power of deploying rational, reasoned arguments and compelling evidence in action. It enabled them to elucidate their standpoint through utilizing rhetorical eloquence and enhance the skills of researching, organizing, and presenting information in a compelling fashion.

Activity with newspaper coverage if any:

Activity data save in PC of: English Department

Prof. Pitambar Humane
IQAC Coordinator

CO ORDINATOR
INTERNAL QUALITY ASSURANCE CELL
DHARAMPETH, M. P. DEO MEMORIAL &
SCIENCE COLLEGE, NAGPUR

Dr. Mrs. Shraddha Deshpande

Teacher Incharge

Dr. Akhilesh Peshwe

Principal

Dharampeth M.P. Deo Memorial
Science College, Nagpur



Dharampeth M.P. Deo Memorial Science College, Nagpur

Department of English

NOTICE

Academic Session 2022-2023

DEBATE COMPETITION

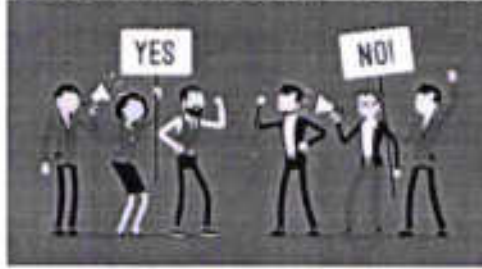

All the students are hereby informed that English Department is organizing **Debate Competition** on following topic:

★ **Pocket Money should be given to children.**

- There will be two members in one team. (One for FOR and one for AGAINST)
- Time for each participant will be 5 mins.
- Language: Hindi, Marathi or English.
- Debate will be held on: 13 January 2023 at. 2.30 p.m. in room No.09.

Dr. Shraddha Deshpande
Head,
Department of English

Dr. Shraddha Deshpande
Head, Department of English
Dharampeth M.P. Deo Memorial
Science College, Nagpur



DHARAMPETH M. P. DEO MEMORIAL SCIENCE COLLEGE,
North Ambazari Road, Near Ambazari Lake, Nagpur- 440033

DATA VALIDATION & VERIFICATION (DVV)

Name of the Programme : Debate (Supplementary Eng).
Date of the Programme : 13/01/2023
Name of Chief Guest if any : _____
Name of Guest Speaker if any : _____

Sr. No.	Name of the Participant	Mobile Number	E-mail Id	Signature
1	Janvi H. Laibey	8446510539	Jhanviklaibey@gmail.com	
2	Rutika G. Yadav	8446085943	yadavrutika0534@gmail.com	
3	Apeksha D. Kotangale	7559455794	apekshakotangale26@gmail.com	
4	Prachi H. Pardhi	7263935912	Prachipardhi28@gmail.com	
5	Samiksha A. Panchbudhe	9763075890	Samiksha.panchbudhe36@gmail.com	
6	Divyani G. Zade	7972403069	divyanizade2005@gmail.com	
7	Vidya Dhoke	9011681628	aryanamadhoke123@gmail.com	
8	Jagruuti Fulkawar	8767911307	JagruutiFulkawar@gmail.com	
9	Vidya E. Lohr	7020963219	Vidyalohr8@gmail.com	
10	Pranali R. Dehnaker	8767581278	Pdehnar@gmail.com	

Signature of

Dr. Shraddha Deshpande
Head, Department of English
Programme in-charge
Dharampeth M.P. Deo Memorial
Science College, Nagpur

IQAC Co-ordinator
Dharampeth M.P. Deo Memorial
Science College, Nagpur-440033

Principal
Dharampeth M.P. Deo Memorial
Science College, Nagpur-440033



DATA VALIDATION & VERIFICATION (DV)

11	Utkarsha Ingale	7497159128	utkarshaingale@gmail.com	Utkarsha
12	Vaidehi Nagarkar	9325963446	vaidehinagarkarof@gmail.com	Vaidehi
13	Gendal Bhojraj Machade	9112142728	nibhimachadegoo@gmail.com	Gendal
14	Aman S. Karm	9028837552	karm7877@gmail.com	Aman
15	Kartika .M. Deshmukh	9699720960	kartikamad20@gmail.com	Kartika
16	Siddhi .B. Jiwari	8087143696	siddhitiwari07@gmail.com	Siddhi
17	Ved .S. Choudhary	7498972766	vedchoudhary.cs.749@gmail.com	Ved
18	Sakshi Chaudhary	9766341962	schaudhary5599@gmail.com	Sakshi
19	Saurabh Chaudhary	9359883501	sakshichaudhary7433	Saurabh
20	Shivam .V. Patel	1038899083	spou0263@gmail.com	Shivam

Signature of:

Programme In-charge
Dr. Shradha Deshpande
Head, Department of English
Dharampeth M.P. Deo Memorial
Science College, Nagpur

IQAC Coordinator
IQAC Co-ordinator
Dharampeth M.P. Deo Memorial
Science College, Nagpur-440033

Principal
Dharampeth M.P. Deo Memorial
Science College, Nagpur-440033



DHARAMPETH M. P. DEO MEMORIAL SCIENCE COLLEGE, NAGPUR
INTERNAL QUALITY ASSURANCE CELL (IQAC)
Activity Report

Date: 23/01/2023

Name of Organizing Department or Committee: English Department

Name of the activity: Grammar Quiz

Suggested CRITERION point if any: Criteria V

Date of Activity: 13-01-2023

Place of Activity: College

Name of Guest Speaker/s or Judge/s or Chief Guest/s if any: Nil

Title of the Activity: Grammar Quiz

Number of Participants: 07

Name of the Teacher In-charge / Convener: Dr.Mrs.Shraddha Deshpande

Names of other Committee Members / Staff: Dr.Akhilesh Peshwe (Principal)

OUTCOME of the Activity with respect to mission vision of the institute and or academics:

To build up confidence in language acquisition, grammar exercise sand practice is must. Therefore, a grammar quiz was given to students to practice topics taught to them.

Activity with newspaper coverage if any: Nil

Activity data save in PC of: English Department

Prof. Pitambar Humane
IQAC Coordinator

CO ORDINATOR
INTERNAL QUALITY ASSURANCE CELL
DHARAMPETH, M. P. DEO MEMORIAL &
SCIENCE COLLEGE, NAGPUR

Dr. Mrs. Shraddha Deshpande
Teacher Incharge

Dr. Akhilesh Peshwe
Principal
Dharampeth M.P. Deo Memorial
Science College, Nagpur



Dharampeth M.P. Deo Memorial Science College, Nagpur

Department of English

NOTICE

Academic Session 2022-2023

GRAMMAR QUIZ



All the students are hereby informed that English Department is organizing **Grammar Quiz**.

- **Topic: Transformative Grammar**
 1. Active Passive Voice
 2. Assertive, Imperative, Interrogative, Exclamatory, Sentences
 3. Question tag
 4. Degrees of Comparison
- Online quiz based on the above will be shared.
- Quiz will have 30 questions.
- Quiz will be held on 13 January 2023 at 11.30 a.m in Home Science Department.

Dr. Shraddha Deshpande
Head,
Department of English

Dr. Shraddha Deshpande
Head, Department of English
Dharampeth M.P. Deo Memorial
Science College, Nagpur



DHARAMPETH M. P. DEO MEMORIAL SCIENCE COLLEGE,
North Ambazari Road, Near Ambazari Lake, Nagpur - 440033

DATA VALIDATION & VERIFICATION (DV)

Name of the Programme : Grammar Quiz (HSC)
Date of the Programme : 13th January 2023
Name of Chief Guest if any : _____
Name of Guest Speaker if any : _____

Sr. No.	Name of the Participant	Mobile Number	E-mail Id	Signature
1.	Shaly L. Paudhi	8329115380	shalypaudhi@gmail.com	
2.	SAKSHI R. CHAKUNDE	7843018801	SAKSHICHAKUNDE@gmail.com	
3.	Berna J. Chaudhari	7620384149	chaudhari2017092004@gmail.com	
4.	Minal. L. Patle	7350730164	patle.minal84@gmail.com	
5.	Shubhangi R. Nishad	9518534076	shubhnishad2510@gmail.com	
6.	Anshikha U. Jaiswarikar	9021391207	anshikhajaiswarikar@gmail.com	
7.	Hemlata D. Verma	7517058349	vermahemlata@gmail.com	

Signature of:

Program In Charge
Head, Department of Engg.
Dharampeth M.P. Deo Memorial
Science College, Nagpur-440033

IQAC Co-ordinator
Dharampeth M.P. Deo Memorial
Science College, Nagpur-440033

PRINCIPAL
Dharampeth M.P. Deo Memorial
Science College, Nagpur-440033



DHARAMPETH M. P. DEO MEMORIAL SCIENCE COLLEGE, NAGPUR
INTERNAL QUALITY ASSURANCE CELL (IQAC)

Activity Report

Date: 19.01.2023

Name of Organizing Department or Committee: BOTANY DEPARTMENT

Name of the activity: Puzzle on plant nutrients.

Suggested CRITERION point if any: CRITERION-I

Date of Activity: 17.01.2023

Place of Activity: DHARAMPETH M.P. DEO MEMORIAL SCIENCE COLLEGE

Name of Guest Speaker/s or Judge/s or Chief Guest/s if any: Dr. Mrs. Sweta Rai

Title of the Activity: Puzzles on plant nutrients

Number of Participants:19

Name of the Teacher In-charge / Convener: Prof. Pitambar Humane

Names of other Committee Members / Staff: Dr. Chandrakumar Patle, Mr. Amol Pimpalshende, Dr. Mrs. Reshma Hiwase, Dr. Mrs. Sweta Rai & Mrs. Dipali Nikure

OUTCOME of the Activity with respect to mission vision of the institute and or academics:

This activity creates creativity, thinking, cognitive skill among students. This study has developed curiosity and keen interest among students.

Activity with newspaper coverage if any: NA

Activity data save in PC of: Prof. Pitambar Humane's Laptop

Prof. Pitambar Humane
IQAC Coordinator

CO ORDINATOR
INTERNAL QUALITY ASSURANCE CELL
DHARAMPETH, M. P. DEO MEMORIAL &
SCIENCE COLLEGE, NAGPUR

Dr. Sweta A. Rai
Name & Signature of Teacher In-charge

Dr. Akhilesh Peshwe
Principal
Principal
Dharampeth M.P. Deo Memorial
Science College, Nagpur.



DHARAMPETH M. P. DEO MEMORIAL SCIENCE COLLEGE,
North Ambazari Road, Near Ambazari Lake, Nagpur- 440033

DATA VALIDATION & VERIFICATION (DVV)

Name of the Programme : Puzzles on plant nutrients
Date of the Programme : 17, Jan 2023
Name of Chief Guest if any : _____
Name of Guest Speaker if any : _____

Sr. No.	Name of the Participant	Mobile Number	E-mail Id	Signature
1.	Meunali R. Songare	9850163812	songaremeunali16@gmail.com	<u>Meunali</u>
2.	Sakshi V. Chamate	7709204983	chamate.sakshi24@gmail.com	<u>Sakshi</u>
3.	Neha A. Waghade	7249895144	nehawaghade16082002@gmail.com	<u>Neha</u>
4.	Rukhi P. Gedum	7378312504	gedumrukhi2000@gmail.com	<u>Rukhi</u>
5.	Rani B. Katvale	9011247038	katvani8112@gmail.com	<u>Rani</u>
6.	Jayashree D. Hiwaze	7385473157	Jshihhiwaze10@gmail.com	<u>J.D. Hiwaze</u>
7.	Apita T. Dakhale	8010866758	apitadakhale@o2gmail.com	<u>Apita</u>
8.	Vishakha G. Grawhade	7620351270	vishakha2020gg@gmail.com	<u>Vishakha</u>
9.	Sakshi P. Mankar	8180816539	sakshi2018mm@gmail.com	<u>Sakshi</u>
10.	Varshika C. Yede	7558244609	varshikayede1@gmail.com	<u>Varshika</u>

Signature of:

Chitra Rai

Programme In-charge

Chitra Rai
IQAC Coordinator

CO-ORDINATOR
INTERNAL QUALITY ASSURANCE CELL
DHARAMPETH, M. P. DEO MEMORIAL &
SCIENCE COLLEGE, NAGPUR

Chitra Rai
Principal
Principal

Dharampeth M.P. Deo Memorial
Science College, Nagpur.



DHARAMPETH M. P. DEO MEMORIAL SCIENCE COLLEGE,
North Ambazari Road, Near Ambazari Lake, Nagpur- 440033

DATA VALIDATION & VERIFICATION (DVV)

11.	Anjali R. Mishra	8379948106	am36859@gmail.com	Anjali
12.	Sonam M. Upgade	9890230462	upgradesonam@gmail.com	Upgrade
13.	Sushila S. Pushti	7507439390	sushilapushti224@gmail.com	Pushti
14.	Asha S. Landge	9322231581	ashalandge0601@gmail.com	Asha S. Landge
15.	Neha R. Khawase	8766758360	neha2002.kk@gmail.com	Khawase
16.	Priyanka L. Gujwar	9579263881	priyanka.gujwar2006@gmail.com	Priyanka L.
17.	Amisha R. Ando	8767618394	amishal23@gmail.com	Ando
18.	Vaishnavi R. Chandekar	7249882964	vaishnavichandekar@gmail.com	Chandekar
19.	Saniya P. Naik	9370570457	saniyanaiks1@gmail.com	Naik

Signature of:

Programme In-charge

COORDINATOR
INTERNAL QUALITY ASSURANCE CELL
DHARAMPETH, M. P. DEO MEMORIAL &
SCIENCE COLLEGE, NAGPUR

Principal
Principal
Dharampeth M.P. Deo Memorial
Science College, Nagpur



DHARAMPETH M. P. DEO MEMORIAL SCIENCE COLLEGE, NAGPUR
INTERNAL QUALITY ASSURANCE CELL (IQAC)

Activity Report

Date: 19.01.2023

Name of Organizing Department or Committee: BOTANY DEPARTMENT

Name of the activity: To prepare chart on plant physiology

Suggested CRITERION point if any: CRITERION-I

Date of Activity: 18.01.2023

Place of Activity: DHARAMPETH M.P. DEO MEMORIAL SCIENCE COLLEGE

Name of Guest Speaker/s or Judge/s or Chief Guest/s if any: Dr. Mrs. Sweta Rai

Title of the Activity: To prepare chart on plant physiology

Number of Participants:19

Name of the Teacher In-charge / Convener: Prof. Pitambar Humane

Names of other Committee Members / Staff: Dr. Chandrakumar Patle, Mr. Amol Pimpalshende, Dr. Mrs. Reshma Hiwase, Dr. Mrs. Sweta Rai & Mrs. Dipali Nikure

OUTCOME of the Activity with respect to mission vision of the institute and or academics:

This activity creates creativity, thinking, cognitive skill among students. This study has developed curiosity and keen interest among students.

Activity with newspaper coverage if any: NA

Activity data save in PC of: Prof. Pitambar Humane's Laptop

Prof. Pitambar Humane
IQAC Coordinator

CO ORDINATOR
INTERNAL QUALITY ASSURANCE CELL
DHARAMPETH, M. P. DEO MEMORIAL &
SCIENCE COLLEGE, NAGPUR

Name & Signature of Teacher In-charge

Dr. Akhilesh Peshwe
Principal

Dharampeth M.P. Deo Memorial
Science College, Nagpur.



DHARAMPETH M. P. DEO MEMORIAL SCIENCE COLLEGE,
North Ambazari Road, Near Ambazari Lake, Nagpur- 440033

DATA VALIDATION & VERIFICATION (DVV)

Name of the Programme : Poster Competition on Physiology on plant movements
Date of the Programme : 18-01-2023 found in around of college campus or residence.
Name of Chief Guest if any : _____
Name of Guest Speaker if any : _____

Sr. No.	Name of the Participant	Mobile Number	E-mail Id	Signature
1.	Mrunali R. Sonare	9850163812	Sonaremrunali16@gmail.com	<u>Mrunali</u>
2.	Neha. A. Waghade	7249895144	nehawaghade16082002@gmail.com	<u>Neha</u>
3.	Saniya P. Naik	9370570457	saniyonaik51@gmail.com	<u>Saniya</u>
4.	Sakshi V. Chamate	7709209933	chamatesakshi24@gmail.com	<u>Sakshi</u>
5.	Vishakha B. Grawhade	7670351276	vishakha202099@gmail.com	<u>Vg.</u>
6.	Sakshi P. Mankar	8180816539	sakshi2018mm@gmail.com	<u>Mankar</u>
7.	Arpita T. Dakhale	8010866758	arpitadakhale02@gmail.com	<u>A Dkhale</u>
8.	Jayashree D. Hiwase	7385473157	Jehihiwase10@gmail.com	<u>J.D. Hiwase</u>
9.	Sushila S. Puroti	7507439390	SushilaPuroti@224@gmail.com	<u>S Puroti</u>
10.	Sonam M. Upgrade	9890230462	upgradesonam@gmail.com	<u>S Upgrade</u>

Signature of
Sonam M. Upgrade

Programme In-charge

[Signature]

IQAC Coordinator

CO ORDINATOR
INTERNAL QUALITY ASSURANCE CELL
DHARAMPETH, M. P. DEO MEMORIAL &
SCIENCE COLLEGE, NAGPUR

[Signature]

Principal

Principal

Dharampeth M.P. Deo Memorial
Science College, Nagpur.



DHARAMPETH M. P. DEO MEMORIAL SCIENCE COLLEGE,
North Ambazari Road, Near Ambazari Lake, Nagpur- 440033

DATA VALIDATION & VERIFICATION (DVV)

11.	Sakshi S. Gudei	9529660277	sakshigudei2041@gmail.com	Bajis
12.	Akansha S. Bhute	9356964121	akansha2020b@gmail.com	ABhute
13.	Rakhi. P. Gedam	7378312509	rakhiGEDAM@gmail.com	RpGedam
14.	Asha. S. Londge	9322231581	ashalondge@gmail.com	Asha.S. Londge
15.	Rani B katuale	9011247038	bkranib112@gmail.com	RBA
16.	Neha R. Khawase	8766738340	nehar2002kk@gmail.com	NKhawase
17.	Shubham P. Khobragade	9518788915	shubhamkhobragade101@gmail.com	Shubham
18.	Brajwal P. Mungle	9834234902	brajwalmungle12@gmail.com	B P Mungle
19.	Vanshika. C. Yede	7558244609	vanshikayede1@gmail.com	Vanshika

Signature of:

Programme In-charge:

IQAC Coordinator
CO ORDINATOR
INTERNAL QUALITY ASSURANCE CELL
DHARAMPETH, M. P. DEO MEMORIAL &
SCIENCE COLLEGE, NAGPUR

Principal
Principal
Dharampeth M.P. Deo Memorial
Science College, Nagpur.



DHARAMPETH M. P. DEO MEMORIAL SCIENCE COLLEGE, NAGPUR
INTERNAL QUALITY ASSURANCE CELL (IQAC)

NEP Activity Report

Date: 19/01/2023

Name of Organizing Department or Committee: Chemistry Department

Name of the activity: NEP Activity Report (Sem- II, Unit-I)

Suggested CRITERION point if any: Criteria II

Date of Activity: 19/01/2023

Place of Activity: Corridor of Chemistry Department

Name of Guest Speaker/s or Judge/s or Chief Guest/s if any: Nil

Title of the Activity: Model making of Methane and Ethane molecule

Number of Participants: 34

Name of the Teacher In-charge / Convener: Dr. Pranita Gawande

Names of other Committee Members / Staff: Dr. Vaishali Meshram

OUTCOME of the Activity with respect to mission vision of the Institute and or academics:

Hydrocarbon functional moiety begins with C1 and C2 molecule like Methane and ethane. So this activity helps students to understand the basics of chemistry of Hydrocarbon. The model making of these molecules gives an idea about their structures properties like their bonding, bond angle, geometry etc.

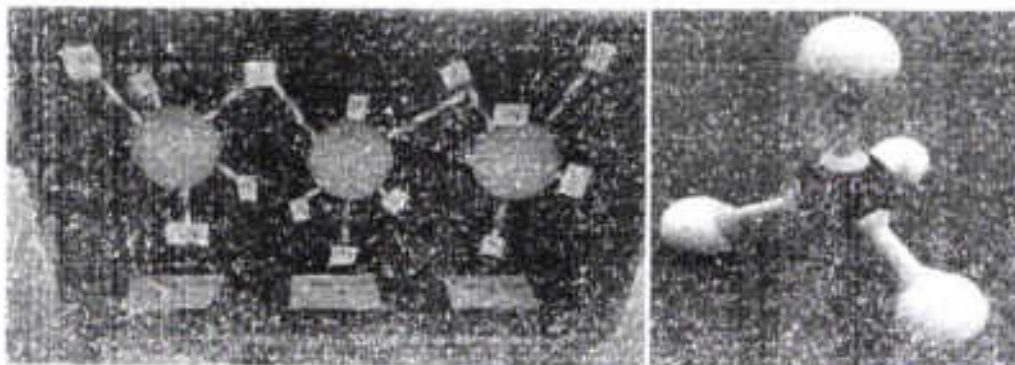

Activity with newspaper coverage if any: Nil

Activity data save in PC of: Chemistry Department

Note: Kindly share geotag photographs separately along with reports on iqacdsr2022@gmail.com

Prof. Pitambar Humane

COORDINATOR

INTERNAL QUALITY ASSURANCE CELL
DHARAMPETH, M. P. DEO MEMORIAL &
SCIENCE COLLEGE, NAGPUR

Pranita (Dr. P.U. Gawande)
Name & Signature of Teacher In-charge

Dr. Akhilesh Feshwe

Principal
PRINCIPAL

Dharampeth M.P. Deo Memorial
Science College, Nagpur-440033



DHARAMPETH M. P. DEO MEMORIAL SCIENCE COLLEGE,
North Ambazari Road, Near Ambazari Lake, Nagpur- 440033

DATA VALIDATION & VERIFICATION (DVV)

Name of the Programme : NEP Activity - Model making of methan & ethane (Sem II, Paper I, unit I)
 Date of the Programme : 19-01-23
 Name of Chief Guest if any : _____
 Name of Guest Speaker if any : _____

Sr. No.	Name of the Participant	Mobile Number	E-mail Id	Signature
1.	Urmang. G. Wasthi	9322428500	urmangwasthi@gmail.com	<u>Urmang</u>
2.	Sonali G. Chaulhoni	8856055003	sonalichaulhoni@gmail.com	<u>Sonali</u>
3.	Ritika R. Sondhiya	9175581655	ritikawasthi@gmail.com	<u>Ritika</u>
4.	Katika. M. Deshmukh	9699720960	Katikam2@gmail.com	<u>Katika</u>
5.	Valdehi P. Thote	7558499191	valdehitote2@gmail.com	<u>Valdehi</u>
6.	Khineshwari R. Pishptode	8624976072	khineshwari_pishptode@gmail.com	<u>Khineshwari</u>
7.	Vaishali M. Sahare	9972925403	Vaishali_sahare251@gmail.com	<u>Vaishali</u>
8.	Ashwini R. Chaudhary	9699792732	chaudharyashwini@gmail.com	<u>A.R. Chaudhary</u>
9.	Shrutika G. Pise	9322316336	shrutikapise67@gmail.com	<u>S. Pise</u>
10.	Shrey G. Bhinte	8637762811	shreyabhinte21@gmail.com	<u>Shrey</u>
11.	Khushi Bharti	9604367894	khushi_bharti@gmail.com	<u>Khushi</u>
12.	Winita Das	8446247894		<u>Winita</u>

Signature of:

P. P. P.
Programme In-charge

[Signature]
IQAC Coordinator
INTERNAL COORDINATOR
DHARAMPETH, M. P. DEO MEMORIAL &
SCIENCE COLLEGE, NAGPUR

[Signature]
Principal
PRINCIPAL
Dharampeth M.P. Deo Memorial
Science College, Nagpur-440033



DHARAMPETH M. P. DEO MEMORIAL SCIENCE COLLEGE,
North Ambazari Road, Near Ambazari Lake, Nagpur- 440033

DATA VALIDATION & VERIFICATION (DVV)

11.	Karishma N. Prasad	9309318667	narendrprasad72@gmail.com	Karishma
12.	Shital . O. Patle.	9764596337	SIP 12@gmail.com.	Shital
13.	Monika . I. Patel	7499225468	MonikaPatel7038@gmail.com	mpatle
14.	Yogita . K. Thakre	7841024445	yogitathakre2584@gmail.com	yithakre.
15.	Durgesh K. Ghodmare	9075318618	durgeshghodmare001@gmail.com	ghodmare
16.	Ruchi . P. Dwivedi	8080776693	Ruchidwivedi230@gmail.com	R.Dwivedi
17.	Ritika . R. Bhojari	9834587087	RitikaRbhojari@gmail.com	Ritika
18.	Saurabh . S Chaudhary	9359883501	schaudhary5599@gmail.com	Schaudhary
19.	Shivam . V. Patel	703888083	sp040263@gmail.com	Shivam
20.	Ankit . R. Patel	9970905638	ankitpatel797275@gmail.com	Ankit
21.	Puatiha . B. Bhusari	7821048413	pbusari718@gmail.com	PBB
22.	Aparna Mohare	7020649887	aparnamohare22@gmail.com	Aparna
23.	Yogita R. Denge	7058487240	yogitadenge@gmail.com	Yogita
24.	Priyanshu Patil	9322725233	Priyanshupatil56@gmail.com	Patil
25.	Nisha Patil	8685231390	anishak 9603231390@gmail.com	Nisha
26.	Komalika Chaudhari	9322033866	Komalikachaudhari67@gmail.com	Komalika
27.	Apeksha Kotangale	7559455794	Apekshakotangale26@gmail.com	Apeksha
28.	Anjali Thakre	7066554821	anjalthakre@gmail.com	Anjali
29.	Vaishnavi Jenge	8421657943	Vaishnavijenge@gmail.com	Vaishnavi

Signature of:

Puy
Programme In-charge

IQAC Coordinator
INTERNAL QUALITY ASSURANCE CELL
DHARAMPETH, M. P. DEO MEMORIAL &
SCIENCE COLLEGE, NAGPUR

Principal
DHARAMPETH M. P. DEO MEMORIAL
Science College, Nagpur-440033



DHARAMPETH M. P. DEO MEMORIAL SCIENCE COLLEGE, NAGPUR
INTERNAL QUALITY ASSURANCE CELL (IQAC)

Date: 24/01/2023

Name of Organizing Department/ Committee: Home Science Department collaboration with Women's Cell

Name of the activity: Method Demonstration on Paper art (NEP Activity) (Best out of waste)

Suggested CRITERION point if any: Criterion II

Date of Activity: 24/01/2023

Place of Activity: Home Science Department

Name of Guest Speaker/s or Judge/s or Chief Guest/s if any: Mr. Prakash Barot

Title of the Activity: Method Demonstration on Paper art

Number of Participants: 10

Name of the Teacher In-charge/Convener: Ms. Ankita Wankhede,

Names of other Committee Members/Staff: Mrs. Manju Deshpande

OUTCOME of the Activity with respect to mission vision of the institute and or academics:

1. Students learn to explore her creativity, built imagination and creation.
2. Paper-crafting can helpful for students to enhance their focus.
3. Students can make paper craft decorations at home for any celebration/ festival

Activity with newspaper coverage if any:

Activity data save in PC of:



Handwritten signature in blue ink.

Handwritten signature in blue ink.

Name & Signature of Teacher In-charge

Handwritten signature of Ankita Wankhede.

Dr. Akhilesh Peshwe

PRINCIPAL

Dharampeth M. P. Deo Memorial
Science College, Nagpur-440033

COORDINATOR
INTERNAL QUALITY ASSURANCE CELL
IQAC Coordinator
DHARAMPETH M. P. DEO MEMORIAL &
SCIENCE COLLEGE, NAGPUR



DHARAMPETH M. P. DEO MEMORIAL SCIENCE COLLEGE,
North Ambazari Road, Near Ambazari Lake, Nagpur- 440033

DATA VALIDATION & VERIFICATION (DVV)

Name of the Programme : Demonstration on Paper Art (NEP)
 Date of the Programme : 20/01/2023
 Name of Chief Guest if any : Prakash Rajot
 Name of Guest Speaker if any : _____

Sr. No.	Name of the Participant	Mobile Number	E-mail Id	Signature
1.	Prerna J. Chaudhari	7620384149	chaudhariprerna2004@gmail.com	<i>Prerna</i>
2.	Anshikha U. Jaiswarikar	9021391207	anshikhajaiswarikar@gmail.com	<i>Anshikha</i>
3.	Minal L. Patil	7350730164	patilminal83@gmail.com	<i>Minal</i>
4.	Shalu L. Pawde	8329115380	shalupawde@gmail.com	<i>Shalu</i>
5.	Aditi R. Vaidya	9075714591	aditivaidya619@gmail.com	<i>Aditi</i>
6.	Gayatri N. Varma	9463284531	gayatriveerma60@gmail.com	<i>Gayatri</i>
7.	Hemlata D. Verma	7517058319	vermahemlata@gmail.com	<i>Hemlata</i>
8.	Bhavana Gundasani	8888437303	bhavonagundasani@gmail.com	<i>Bhavna</i>
9.	Aarohi Kokande			<i>Aarohi</i>
10.	Ashwini Pawde	8308621072	ashwini Pawde 2794@gmail.com	<i>Ashwini</i>

Signature of: *Ankita*
Ankita Lonkhe
 Programme In-charge

[Signature]
ICQS COORDINATOR
 INTERNAL QUALITY ASSURANCE CELL
 DHARAMPETH M. P. DEO MEMORIAL &
 SCIENCE COLLEGE, NAGPUR

[Signature]
Principal
 Dharampeth M.P. Deo Memorial
 Science College, Nagpur-440033



**DHARAMPETH M. P. DEO MEMORIAL SCIENCE COLLEGE, NAGPUR
INTERNAL QUALITY ASSURANCE CELL (IQAC)**

Activity Report

Date: 23/01/23

Name of Organizing Department or Committee: Women Cell

Name of the activity: Inauguration of Women Cell 22-23

Suggested CRITERION point if any: Criteria V

Date of Activity: 20th January 2023

Place of Activity: Home Science Dept

Name of Guest Speaker/s or Judge/s or Chief Guest/s if any: Mrs. Bhakti Dixit

Title of the Activity: Guest Lecture: Best out of Waste

Number of Participants: 86

Name of the Teacher In-charge / Convener: Dr.Mrs.Shraddha Deshpande

Names of other Committee Members / Staff: Mrs.P.R. Ganorkar, Mrs. M.M. Kanhe, Mrs. S.A. Jawade Mrs. Wannere

OUTCOME of the Activity with respect to mission vision of the institute and or academics:

Women Cell Committee of the college inaugurated Women Cell 22-23 20th January 2023 Mrs. Bhakti guided students on how they can utilize their time in making best out of waste. By making decorative articles a home maker can empower herself and can become an entrepreneur in future.

Activity with newspaper coverage if any: Nil

Activity data save in PC of: English Department



Prof. Pitambar Humane
IQAC Coordinator
CO ORDINATOR
INTERNAL QUALITY ASSURANCE CELL
DHARAMPETH, M. P. DEO MEMORIAL &
SCIENCE COLLEGE, NAGPUR

Dr. Shraddha Deshpande
Convener

Dr. Akhilesh Peshwe
PRINCIPAL
Dharampeth M.P. Deo Memorial
Science College, Nagpur-440 033

DHARAMPETH M.P.DEO MEMORIAL SCIENCE COLLEGE,
NAGPUR

WOMEN CELL 2022-2023

NOTICE

Date: 19/01/2023

All the staff members are hereby informed that Inauguration of Women's Cell 2023 in collaboration with Home Science Department will be held on 20/01/2023 at 1.00 p.m in Home Science Department.

Mrs. Bhakti Dixit will be guiding on 'Best out of Waste' Students should attend the program positively.

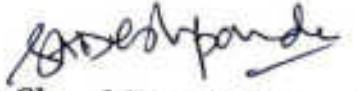
Dr. Mrs. Shraddha Deshpande
Convener
Women Cell 22-23



DHARAMPETH M. P. DEO MEMORIAL SCIENCE COLLEGE
North Ambazari Road, Near Ambazari Lake, Nagpur- 440033

DATA VALIDATION & VERIFICATION (DVV)

Name of the Programme : Inauguration of Women Cell (Be out of Waste)
Date of the Programme : 20th January 2023
Name of Chief Guest if any : Mrs. Bhakti Dixit
Name of Guest Speaker if any : -

Sr. No.	Name of the Participant	Mobile Number	E-mail Id	Signature
1	SAKSHI .R. CHAKUNDE	7843018801	sakshichakunde@gmail	
2	Neha .R. Vishwakarma	8983534175	nehavishwakarma55083@gmail.com	
3	Anshikha U. Jaiswarakar	9021391207	anshikhajaiswarakar@gmail.com	
4	Prema J. Chaudhari	7620384149	chaudhariprema294@gmail.com	
5	Shubhangi .R. Nishad	9518534076	shubhnishad251@gmail.com	
6	Hemlata D. Verma	7577058379	vankhata957@gmail.com	
7	Shalu Y. Patil	8329115380	shalupatils@gmail.com	
8	Minal Z. Patle	7350730164	minalpatle83@gmail.com	
9	Aditi vaidya	9075714591	Aditivaidya619@gmail.com	
10	Khushi .R. Pali	876760724	palikhushi@gmail.com	

Signature of:

Programme In-charge

COORDINATOR
INTERNAL QUALITY ASSURANCE CELL
DHARAMPETH, M. P. DEO MEMORIAL &
SCIENCE COLLEGE, NAGPUR

PRINCIPAL
Dharampeth - M.P. Deo Memorial
Science College, Nagpur-440 033



DHARAMPETH M. P. DEO MEMORIAL SCIENCE COLLEGE,
North Ambazari Road, Near Ambazari Lake, Nagpur- 440033

DATA VALIDATION & VERIFICATION (DVV)

10.	Vaishnavi . K. Pradhan	9763169560	pradhanvaishnavi15@gmail.com	vaishnavi
11.	Shrushti Patkar	7387067403	shrushtipatkar@gmail.com	shrushti
12.	Pellavi Katre	8459277408	pkatre573@gmail.com	pellavi
13.	Bhaggashree Ambule.	9354139068	ambulebh667@gmail.com	Ambule
14.	Kimaya Kate	8866073792	kimayakate@gmail.com	Kimaya
15.	Tannu S. korde	7841984450	kordeannu33@gmail.com	Tannu
16.	Avani S. Shenwai	9096507459	avanishenwai15@gmail.com	Avani
17.	Ojasvi Wankhede	8767699751	wankhedeojasvi@gmail.com	Ojasvi
18.	Pragya S. Tiwari	6394098386	Pragyatiwari14052003@gmail.com	Pragya
19.	Priya K. Khawshi	9763617224	priyakhawshi30@gmail.com	Priya
20.	Prachi N. Lanekar.	8806244419	prachilanekar159@gmail.com	Prachi
20.	Khushbu Pali	8459565214	paliKhushbu59@gmail.com	Khushbu
21.	Harshata Wankhede	8263977208	harshatawankhede@gmail.com	Harshata
22.	Tannu Vasthi	9322044903	tannuvasthi@gmail.com	Tannu
23.	Dharmapriya R Lale	9975037856	dharmapriya15@gmail.com	Dharmapriya
24.	Renuka Lanade	7719951401	renukalanade22@gmail.com	Renuka

Signature of:

S. A. Dhedpande
Programme In-charge

[Signature]
CO-ORDINATOR
INTERNAL QUALITY ASSURANCE CELL
DHARAMPETH, M. P. DEO MEMORIAL &
SCIENCE COLLEGE, NAGPUR

[Signature]
PRINCIPAL
Dharampeth M.P. Deo Memorial
Science College, Nagpur-440033



DHARAMPETH M. P. DEO MEMORIAL SCIENCE COLLEGE,
North Ambazari Road, Near Ambazari Lake, Nagpur- 440033

DATA VALIDATION & VERIFICATION (DVV)

Name of the Programme :

Best out of Waste (Demonstration)

VEP Activity

Date of the Programme :

20/11/23

Name of Chief Guest if any :

Mrs. Bhakti Dixit

Name of Guest Speaker if any :

Sr. No.	Name of the Participant	Mobile Number	E-mail Id	Signature
1	Shalu f. Poydhi	8329115380	shalupoydhi3@gmail.com	Shalu
2	Aditi R Vaidya	9075714591	aditivaidya619@gmail.com	Aditi
3	Preema J. Chaudhari	7620384149	chaudharipreema99@gmail.com	Preema
4	Anshikha U. Jarwarkar	9021391207	anshikhyjarwarkar@gmail.com	Anshikha
5	Hemalata D. Verma	7517058349	vermahemalata88@gmail.com	Hemalata
6	Shubhangi R. Nishad	9518534076	shubhnishad2510@gmail.com	Shubhangi
7	Pranali G. Gangadkar	9809079427	Pranali02gh@gmail.com	Pranali
8	Sujata V. Kaurse	9175451202	SujataKaurse1@gmail.com	Sujata
9	Bhagyashree S. Ambule	9359139668	ambuleb66@gmail.com	Bhagyashree
10	Shalinam T. Madani	9022302785	shalinammadani@gmail.com	Shalinam

Signature of:

Ankita Kantchede
Programme In-charge

IQAC Coordinator
IQAC Co-ordinator
Dharampeth M.P. Deo Memorial
Science College, Nagpur-440033

Principal



DHARAMPETH M. P. DEO MEMORIAL SCIENCE COLLEGE, NAGPUR
INTERNAL QUALITY ASSURANCE CELL (IQAC)

Activity Report

Date: 23.01.2023

Name of Organizing Department or Committee: BOTANY DEPARTMENT

Name of the activity: Field study (NEP-2022 Activity)

Suggested CRITERION point if any: CRITERION-I

Date of Activity: 23.01.2023

Place of Activity: College Botanical Garden

Name of Guest Speaker/s or Judge/s or Chief Guest/s if any: NA

Title of the Activity: To Study the plants used in Gardening

Number of Participants: 30

Name of the Teacher In-charge / Convener: Prof. Pitambar Humane

Names of other Committee Members / Staff: Dr. Chandrakumar Patle, Mr. Amol Pimpalshende, Dr. Mrs. Reshma Hiwase, Dr. Mrs. Sweta Rai & Mrs. Dipali Nikure

OUTCOME of the Activity with respect to mission vision of the institute and or academics:

The students were taken in botanical garden to make them aware about the garden flora. The students were provided botanical names of the many plants cultivated in the garden.

Activity with newspaper coverage if any: NA

Activity data save in PC of: Prof. Pitambar Humane's Laptop



Prof. Pitambar Humane
IQAC Coordinator
CO ORDINATOR
INTERNAL QUALITY ASSURANCE CELL
DHARAMPETH, M. P. DEO MEMORIAL &
SCIENCE COLLEGE, NAGPUR

Name & Signature of Teacher In-charge

Dr. Anillesh Peshwe
Principal
Principal
Dharampeth M.P. Deo Memorial
Science College, Nagpur.



DHARAMPETH M. P. DEO MEMORIAL SCIENCE COLLEGE,
North Ambazari Road, Near Ambazari Lake, Nagpur- 440033

DATA VALIDATION & VERIFICATION (DVV)

Name of the Programme : To study the ornamental/garden plants from Angiosperms.
Date of the Programme : 31/03/2023
Name of Chief Guest if any : _____
Name of Guest Speaker if any : _____

Sr. No.	Name of the Participant	Mobile Number	E-mail Id	Signature
1.	Lucky A Vishwakarma	9579660186	lvishwakarma@xogmail.com	<u>L Vishwakarma</u>
2.	Ashalesha Khadgi	7820929579	Ashaleshakhadgi@gmail.com	<u>Ashalesha K</u>
3.	Sunaina Chichonde	8530970132	Sunainachichonde123@gmail.com	<u>Sunaina</u>
4.	Priya Sharma	8010764549	prijasharma19012004@gmail.com	<u>Priya</u>
5.	Tanu Dhawale	8459543857	tanudhawale7@gmail.com	<u>Dhawale</u>
6.	Bhanashree U. Dhamane	7774900320	bhanashree@dmu.ac.in	<u>Bhanashree</u>
7.	Nisha Parde	8605251390	atishik.Parde8605251390@gmail.com	<u>Nisha</u>
8.	Sanjana .S. Tabhane	9699186571	tabhanesanjana@gmail.com	<u>Sanju</u>
9.	Yachang K. Pandey	9156035297	pandey/yk54@gmail.com	<u>Pandey</u>
10.	Himanshi Kalbunde	9665301444	kalbandehimanshi@gmail.com	<u>H Kalbunde</u>
11.	Sefal Kolhe	8483045985	kolhesefal04@gmail.com	<u>Kolhe</u>
12.	Apeksha D. Katangale	7559455794	apekshakatangale26@gmail.com	<u>Akatangale</u>
13.	Anshul Y. Kinnarpure	9284067169	anshulkinnarpure650@gmail.com	<u>Anshul</u>
14.	Vaishnavi N. Tenge	8421657963	Vaishutenge2004@gmail.com	<u>Tenge</u>

Signature of:

Programme In-charge

INTERNAL COORDINATOR
IQAC Coordinator

Principal



DHARAMPETH M. P. DEO MEMORIAL SCIENCE COLLEGE,
North Ambazari Road, Near Ambazari Lake, Nagpur- 440033

DATA VALIDATION & VERIFICATION (DVV)

Sr. No.	Name of the Participant	Mobile Number	E-mail Id	Signature
15	Anvay Borkar	9168538614	anvayborkar19@gmail.com	Anvay
16	Anjali R. Thakore	7066554821	thakoreanjali@gmail.com	Anjali
17	Kemalika Chaudhari	9322033866	pragmatika.chaudhari@gmail.com	Kemalika
18	Priyanshu Raut	9322725233	priyanshura@gmail.com	Priyanshu
19	Kalyani R. Sindram	8446539622	sindramkalyani@gmail.com	Kalyani
20	Nikita S. Das	8446297880	Nikita5970@gmail.com	N. Das
21	Khushi Bharti	9604367894	2003khushibharti@gmail.com	Khushi
22	Aasiya S. Hussain	7066411418	hussainasiya894@gmail.com	A. Hussain
23	Ravinder Khadse	8009198273	ichadseravinder892@gmail.com	Ravinder
24	Yogita R. Denge	7058437260	yogitadenge@gmail.com	Yogita
25	Arya Dhoke	901681628	aryamarnate1331@gmail.com	Arya
26	Aparna Mahare	7020649887	parnamahare23@gmail.com	Aparna
27	Aakasha Kbbagade	7972228707	aakasha.kbbagade@gmail.com	Aakasha
28	Gunjan Bohay	7686799586	gunjanbohaygunjan@gmail.com	Gunjan
29	Amisha Arkar	7666559171	amishaarkar@gmail.com	Amisha
30				
31				
32				

Signature of:
Programme In-charge

IQAC Coordinator

Principal
Dharampeth M. P. Deo Memorial
Science College



DHARAMPETH M. P. DEO MEMORIAL SCIENCE COLLEGE, NAGPUR
INTERNAL QUALITY ASSURANCE CELL (IQAC)

Activity Report

Date: 27/01/2023

Name of Organizing Department or Committee:

Name of the activity: Vocabulary Quiz

Suggested CRITERION point if any: Criteria V

Date of Activity: 23-01-2023

Place of Activity: College

Name of Guest Speaker/s or Judge/s or Chief Guest/s if any: Nil

Title of the Activity: Vocabulary Quiz

Number of Participants: 22

Name of the Teacher In-charge / Convener: Dr.Mrs.Shraddha Deshpande

Names of other Committee Members / Staff: Dr.Akhilesh Peshwe (Principal)

OUTCOME of the Activity with respect to mission vision of the institute and or academics:

Students were given quiz based on one word substitution so that their vocabulary be improved. This activity helped them to understand and revise the words and their meanings in a structured manner.

Activity with newspaper coverage if any: Nil

Activity data save in PC of: English Department

Prof. Pitambar Humane
IQAC Coordinator

CO ORDINATOR
INTERNAL QUALITY ASSURANCE CELL
DHARAMPETH, M. P. DEO MEMORIAL &
SCIENCE COLLEGE, NAGPUR

Dr. Mrs. Shraddha Deshpande
Teacher Incharge

Dr. Akhilesh Peshwe
Principal
Dharampeth M.P. Deo Memorial
Science College, Nagpur.



Dharampeth M.P.Deo Memorial Science College, Nagpur

Department of English

NOTICE

Academic Session 2022-2023

VOCABULARY QUIZ



All the students are hereby informed that English Department is organizing **Vocabulary Quiz** on following theme:

1. Foreign Words used in English
2. One word for a group of word
3. Idioms and phrases

- Quiz will be held Online on 23 January 2023 at 2.30 p.m. in room No.09
- Quiz will have 30 questions.

Dr. Shraddha Deshpande
Head,
Department of English



DHARAM PETH M. P. DEO MEMORIAL SCIENCE COLLEGE,
North: Ambazari Road, Near Ambazari Lake, Nagpur- 440033

DATA VALIDATION & VERIFICATION (DVV)

Name of the Programme : Vocabulary Quiz (S.E. Sem-I)
Date of the Programme : 23 January 2023
Name of Chief Guest if any : -
Name of Guest Speaker if any : -

Sr. No.	Name of the Participant	Mobile Number	E-mail Id	Signature
1	Gendal Bhojraj Meehade	9112149728	nithilmeehade2008@gmail.com	<u>Gendal Meehade</u>
2	Pranali R. Debnathgar	8767581278	pranali@gmail.com	<u>Pranali R.D</u>
3	Samiksha A. Panchbudhe	9763075890	samikshapanchbudhe63@gmail.com	<u>S.Panchbudhe</u>
4	Prachi H. Pardhi	7263935912	prachipardhi282@gmail.com	<u>P.H. Pardhi</u>
5]	Rutika G. Yadav	8446085943	yadavrutika134@gmail.com	<u>Rutika</u>
6]	Janhvi H. Laibex	8466510539	Jhanvilaibex@gmail.com	<u>Janhvi</u>
7]	Apeksha D. Kolongale	7559455794	apekshakolongale26@gmail.com	<u>Akolongale</u>
8]	Aufali Meshram	7767905722	aufalimeshram2022@gmail.com	<u>Aufali</u>
9]	Ved. S. Choudhary	7498572768	vedchoudhary.cs.749@gmail.com	<u>Ved</u>
10]	Siddhi B. Tiwari	8084148696	siddhitiwari021@gmail.com	<u>Siddhi</u>

Signature of:

[Signature]
Dr. Shradha Deshpande
Head Programme in Charge
Dharam Peth M. P. Deo Memorial
Science College, Nagpur

[Signature]
IQAC Coordinator
Dharam Peth M. P. Deo Memorial
Science College, Nagpur-440033

[Signature]
Principal
Dharam Peth M. P. Deo Memorial
Science College, Nagpur-440033



DHARAMPETH M. P. DEO MEMORIAL SCIENCE COLLEGE,
North Ambazari Road, Near Ambazari Lake, Nagpur- 440033

DATA VALIDATION & VERIFICATION (DVV)

11)	Katika M. Deshmukh	9699720960	katikamd20@gmail.com	Katikam
12)	Aman S karn	9028837552	karn7817@gmail.com	Aman
13)	Jagauti. G. Fullkwar	8767911307	Jagautifullkwar@gmail.com	Jagauti
14)	Shivam patel	7038889083	sp040263@gmail.com	Shivam
15)	Saurabh Chaudhary	9766341962	schaudhary5599@gmail.com	Saurabh
16)	Sakshi Chaudhary	9359883501	sakshichaudhary773399@gmail.com	Sakshi
17)	Vidya Lohi	7020963219	Vidyalohi8@gmail.com	Vidya
18)	Poochi Gajbhaye	751759426	poochigajbhaye@gmail.com	Poochi
19)	Vaideli Nagarkar	9825963446	vaidelinagarkar07@gmail.com	Vaideli
20.	Ankit Patel	9970905638	ankitpatel7977@gmail.com	Ankit
21	Mahima Khare	9545918678	mahimakhare11@gmail.com	Mahima
22.	Divyani G. Zade	7972403069	divyanizade2005@gmail.com	Divyani

Signature of:

Programme In-charge

Dr. Shraddha Deshpande
Head, Department of English,
Dharampeth M.P. Deo Memorial
Science College, Nagpur

IQAC Coordinator

IQAC Co-ordinator

Dharampeth M.P. Deo Memorial
Science College, Nagpur-440033

PRINCIPAL

Dharampeth M.P. Deo Memorial
Science College, Nagpur-440033



DHARAMPETH M. P. DEO MEMORIAL SCIENCE COLLEGE, NAGPUR
INTERNAL QUALITY ASSURANCE CELL (IQAC)

Activity Report

Date: 27/01/2023

Name of Organizing Department or Committee:

Name of the activity: Listening Skills Quiz

Suggested CRITERION point if any: Criteria V

Date of Activity: 23-01-2023

Place of Activity: College

Name of Guest Speaker/s or Judge/s or Chief Guest/s if any: Nil

Title of the Activity: Listening Skills Quiz

Number of Participants: 07

Name of the Teacher In-charge / Convener: Dr.Mrs.Shraddha Deshpande

Names of other Committee Members / Staff: Dr.Akhilesh Peshwe (Principal)

OUTCOME of the Activity with respect to mission vision of the institute and or academics:

Students were given three Listening skills audios and were asked to solve exercise based on the audios. This helped them to practice English text and taught them to focus, comprehend, analyse it.

Activity with newspaper coverage if any: Nil

Activity data save in PC of: English Department

Prof. Pitambar Humane
IQAC Coordinator

CO ORDINATOR
INTERNAL QUALITY ASSURANCE CELL
DHARAMPETH, M. P. DEO MEMORIAL &
SCIENCE COLLEGE, NAGPUR

Dr. Mrs. Shraddha Deshpande
Teacher Incharge

Dr. Akhilesh Peshwe
Principal
Principal
Dharampeth M.P. Deo Memorial
Science College, Nagpur.



Dharampeth M.P. Deo Memorial Science College, Nagpur

Department of English

NOTICE

Academic Session 2022-2023

LISTENING SKILLS QUIZ



All the students are hereby informed that English Department is organizing **Listening Skills Quiz**.

- A Text (Story/Essay/Speech) in English Language will be recited in the class.
- Online quiz based on the above will be shared.
- Quiz will have 30 questions.
- Quiz will be held on 23 January 2023 at 11.30 a.m in Home Science Department.

Dr. Shraddha Deshpande
Head,
Department of English

Dr. Shraddha Deshpande
Head, Department of English
Dharampeth M.P. Deo Memorial Science College, Nagpur



DHARAMPETH M. P. DEO MEMORIAL SCIENCE COLLEGE,
North Ambazari Road, Near Ambazari Lake, Nagpur- 4400 3

DATA VALIDATION & VERIFICATION (DVV)

Name of the Programme : Listening skills Quiz (Hsc)
Date of the Programme : 23/01/2023
Name of Chief Guest if any : _____
Name of Guest Speaker if any : _____

Sr. No.	Name of the Participant	Mobile Number	E- mail Id	Signature
1.	Shalu I. Pandhi	8329115380	shalupandhi3@gmail.com	
2.	SAKSHI R. CHAKUNDE	7843018801	sakshi chakunde@gmail.com	
3.	Preema J. Chaudhari	7620384149	chaudharipreemaes@gmail.com	
4.	Minal I. Patte	7350730164	patteminal84@gmail.com	
5.	Anshikha U. Josawarkar	9021891207	anshikhajosawarkar@gmail.com	
6.	Shubhangi R. Nishad	9515534076	shubhnishad2510@gmail.com	
7.	Hemlata Dhanau Verma	7517058379	vermahemlata957@gmail.com	

Signature of:

Dr. Shafadha Deshpande
Head, Programme in-charge
Dharampeth M.P. Deo Memorial
Science College, Nagpur

IQAC Co-ordinator
Dharampeth M.P. Deo Memorial
Science College, Nagpur-440033

PRINCIPAL
Dharampeth M.P. Deo Memorial
Science College, Nagpur



DHARAMPETH M. P. DEO MEMORIAL SCIENCE COLLEGE, NAGPUR
INTERNAL QUALITY ASSURANCE CELL (IQAC)

Activity Report

Date: 25/01/2023

Name of Organizing Department or Committee: Chemistry

Name of the activity: Faculty Development Programme for Staff members

Suggested CRITERION point if any: Criteria I

Date of Activity: 23/01/2023 to 24/01/2023

Place of Activity: Central AGMARK Laboratories Nagpur

Name of Guest Speaker/s or Judge/s or Chief Guest/s if any: Dr Mrs .Manavi Sharma

Title of the Activity: Faculty Development Programme

Number of Participants: 27

Name of the Teacher In-charge / Convener: - Dr. Vaishali Meshram

Names of other Committee Members / Staff : Mr.Santosh Mhaske, Mr.Sudhir Choudhari

OUTCOME of the Activity with respect to mission vision of the institute and or academics:

Two days faculty development programme was organised in Central AGMARK laboratories, All non-teaching staff of College was participated. They got the information about how to identify food adulteration, and why AGMARK is necessary on Food Items.

Activity with newspaper coverage if any: ----No

Activity data save in PC of: Chemistry



Prof. Pitambar Humane

IQAC Coordinator
CO ORDINATOR
INTERNAL QUALITY ASSURANCE CELL
DHARAMPETH, M. P. DEO MEMORIAL &
SCIENCE COLLEGE, NAGPUR

Name & Signature of Teacher In-charge

Dr. Akhilesh Peshwe

Principal
PRINCIPAL
Dharampeth M.P. Deo Memorial
Science College, Nagpur-440033

**DHARAMPETH M. P. DEO MEMORIAL SCIENCE COLLEGE,
NAGPUR**

**ACADEMIC YEAR :- 2022-2023
(LABORATORY STAFF)**

Sr No	Name of the Staff	Designation	Signature
1	Shri Sandeep Vijayrao, Dekate	Laboratory Assistant	
2	Shri Abhay Chandrashekhar Naik	Laboratory Attendant	
3	Shri Ravindra Mohanrao Wadive	Laboratory Assistant	
4	Shri Sadhir Yashwantrao Choudhari	Laboratory Assutant	
5	Shri Santosh Dattuji Maske	Laboratory Attendant	
6	Shri Vinesh Narayan Ambade	Laboratory Attendant	
7	Shri Shashank Anant Bangale	Laboratory Attendant	
8	Shri Deelip Ganpatrao Choudhari	Laboratory Attendant	
9	Shri. Shriram Sudamji Patilkar	Laboratory Attendant	
10	Shri Gulab, Dadaji Pajai	Laboratory Attendant	
11	Shri Ajay Krushnarao Lanjewar	Laboratory Attendant	
12	Shri Bhushan Benuram Patle	Laboratory Attendant	
13	Shri Kamlesh Bhimrao Buchunde	Laboratory Attendant	
14	Shri Anil Nirturam Garkate	Laboratory Attendant	
15	Smt. Kala Rakesh Banafar	Laboratory Attendant	
16	Shri Jitendra, Sheshrao Wankhede	Laboratory Attendant	
17	Shri Narendra Bhalchandra Tamboli	Laboratory Attendant	
18	Smt. Rekha, Ramdas Katankar	Laboratory Attendant	
19	Smt. Vaishali Vasant Labde	Laboratory Attendant	
20	Dr. Pooanita U. Gawande	Assistant Professor	
21	Dr. Mrs. Marudul R. Keskar	Assistant Professor	
22	Dr. Deepika Brijpuria	Assistant Professor	
23	Dr. Mrs. Yogita Morey (Dahize)	Assistant Professor	
24	Shri. Anmol M. Ramal		
25	Dr. Sandip M. Bhisagade	Assistant professor	
26	Mrs. Avanti Kulkarni	"	
27	Niharika A. Sute	"	



DHARAMPETH EDUCATION SOCIETY'S
DHARAMPETH M.P.DEO MEMORIAL SCIENCE COLLEGE NAGPUR



In Association with Central Agmark Lab
FACULTY DEVELOPMENT PROGRAMME

2022-23

(23rdJan. to 24th Jan., 2023)

Registration Form

Name Of the Participant (in Capital) : _____
Department : _____
Gender (Male/Female) : _____
Phone No. (Office) : _____
Mobile No. : _____
Education : _____
Address : _____

Sign of the Participant

Dr. Vaishali P. Meshram
Convener

Dr. Akhlesh V. Peshwe

Principal
PRINCIPAL
Dharampeth M.P. Deo Memorial
Science College, Nagpur-440013



DHARAMPETH M. P. DEO MEMORIAL SCIENCE COLLEGE, NAGPUR

INTERNAL QUALITY ASSURANCE CELL (IQAC)

Activity Report

Date: 23rd January 2023

Name of Organizing Department or Committee : Electronics Department

Name of the Activity : To study electrical characteristics of PN diode, Zener diode and LED using datasheet

Suggested CRITERION point if any : Suggested criteria II

Date of Activity : 23rd January 2023

Place of Activity : Electronics Lab

Name of Guest Speaker/s or Judge/s or Chief Guest/s if any : Not applicable

Title of the Activity: To study electrical characteristics of PN diode, Zener diode and LED using datasheet

Based on Unit : 1(Paper I)

Class : Semester II

Number of Participants : 18

Name of the Teacher In-charge / Convener: Mrs. Leena P. Thakare

OUTCOME of the Activity with respect to mission vision of the institute and or academics:

Students studied the technical specifications and applications of 1N4001-1N4007 Rectifier diode, 1N4728-1N4761 Zener diode, TLUR6400 LED using datasheet.

Prof. Prakash H. H.
CO ORDINATOR
INTERNAL QUALITY ASSURANCE CELL
IQAC Coordinator
DHARAMPETH, M. P. DEO MEMORIAL &
SCIENCE COLLEGE, NAGPUR

Dr. Varsha V. Rangari
Professor & Head
Head of the Department
Dharampeth M. P. Deo Memorial
Science College, Nagpur

Dr. Akhilesh Peshwe
Principal
Dharampeth M. P. Deo Memorial
Science College, Nagpur.



DHARAMPETH M. P. DEO MEMORIAL SCIENCE COLLEGE, NAGPUR

Department of Electronics

Semester II- (2022-23)

Activity (Paper I- Unit- 1)

Sr. No.	Student Name	Mobile Number	Email ID
1	Ved Sudhir Choudhary	7498572766	vedchoudhary.cs.749@gmail.com
2	Sandeep Rakesh Kumar Kumar	8081144948	sandeepk27900@gmail.com
3	Abhishek Ravindra Singh	8208948107	abhi0882005@gmail.com
4	Tushal Rupkumar Achare	9075995617	acharetushal5@gmail.com
5	Tejas Ramesh Dongre	9322578918	tejasdongre453@gmail.com
6	Vedant Onkar Umretkar	9049932753	umretkarvedant@gmail.com
7	Kashish Kamaikumar Bisen	7887886117	kashishbisen05@gmail.com
8	Bhagyashali Dadarao Neware	7796434177	sakshineware2017@gmail.com
9	Isha Ishwar Waghmare	8855919474	ishawaghmare9474@gmail.com
10	Khushi Rajiv Pali	8767607224	palikhushi4@gmail.com
11	Tannu Arun Varthi	9322044903	tannuvarthi@gmail.com
12	Simran Narendra Dhimole	8390347026	mishralaxmi210@gmail.com
13	Tanu Ajay Singh	8806355808	tanusingh63492@gmail.com
14	Khushbu Rajiv Pali	8459565214	palikhushbu59@gmail.com
15	Harshata Gunderao Warkhede	9860432428	bandukeshao20@gmail.com
16	Aayushi Vikram Singh	9595119942	senxerox04@gmail.com
17	Vineet Mukesh Singh	9766035354	vineetsingh3533@gmail.com
18	Yogita Jaysing Karemore	8381045307	swara.karemore25@gmail.com

Name & Signature of Teacher In-Charge

Prof. Pitambar Humane

IQAC Coordinator
CO ORDINATOR

INTERNAL QUALITY ASSURANCE CELL
DHARAMPETH, M. P. DEO MEMORIAL &
SCIENCE COLLEGE, NAGPUR

Name & Signature of Head of the
Department

Dr. Varsha V. Rangari
Professor & Head
Department of Electronics
Dharampeth M.P. Deo Memorial
Science College, Nagpur

Dr. Akhilesh Peshwe
Principal

Principal
Dharampeth M.P. Deo Memoria
Science College, Nagpur.

Features

- Diffused Junction
- High Current Capability and Low Forward Voltage Drop
- Surge Overload Rating to 30A Peak
- Low Reverse Leakage Current
- Lead Free Finish, RoHS Compliant (Note 3)

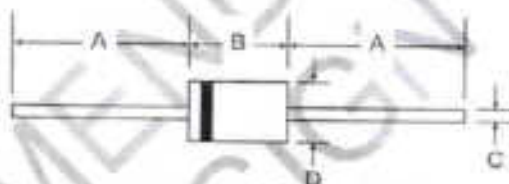

Dim	DO-41 Plastic	
	Min	Max
A	25.40	—
B	4.08	5.21
C	0.71	0.864
D	2.00	2.72
All Dimensions in mm		

Mechanical Data

- Case: DO-41
- Case Material: Molded Plastic, UL Flammability Classification Rating 94V-0
- Moisture Sensitivity: Level 1 per J-STD-020D
- Terminals: Finish - Bright Tin, Plated Leads Solderable per MIL-STD-202, Method 208
- Polarity: Cathode Band
- Ordering Information: See Page 2
- Marking: Type Number
- Weight: 0.30 grams (Approximate)

Maximum Ratings and Electrical Characteristics (@T_A = +25°C unless otherwise specified.)

Single phase, half wave, 60Hz, resistive or inductive load.
For capacitive load, derate current by 20%.

Characteristic	Symbol	1N4001	1N4002	1N4003	1N4004	1N4005	1N4006	1N4007	Unit
Peak Repetitive Reverse Voltage	V _{RRM}								V
Working Peak Reverse Voltage	V _{WRM}	50	100	200	400	600	800	1000	V
DC Blocking Voltage	V _R								V
RMS Reverse Voltage	V _{RRMS}	35	70	140	280	420	560	700	V
Average Rectified Output Current (Note 1) @ T _A = +75°C	I _O	1.0							A
Non-Repetitive Peak Forward Surge Current 8.3ms Single Half Sine-Wave Superimposed on Rated Load	I _{FSM}	30							A
Forward Voltage @ I _F = 1.0A	V _{FM}	1.0							V
Peak Reverse Current @ T _A = +25°C	I _{RS}	5.0							µA
at Rated DC Blocking Voltage @ T _A = +100°C	I _{RS}	50							µA
Typical Junction Capacitance (Note 2)	C _J	15			8				pF
Typical Thermal Resistance Junction to Ambient	R _{θJA}	100							K/W
Maximum DC Blocking Voltage Temperature	T _A	+150							°C
Operating and Storage Temperature Range	T _A , T _{STG}	-65 to +150							°C

- Notes:
1. Leads maintained at ambient temperature at a distance of 2.5mm from the case.
 2. Measured at 1.0 MHz and applied reverse voltage of 4.0V DC.
 3. EU Directive 2002/95/EC (RoHS). All applicable RoHS exemptions applied, see EU Directive 2002/95/EC Annex Notes.

1N4728A - 1N4761A

1.0W ZENER DIODE

Features

- 1.0 Watt Power Dissipation
- 3.3V - 75V Nominal Zener Voltage
- Standard V_Z Tolerance is 5%
- Lead Free Finish, RoHS Compliant (Note 2)

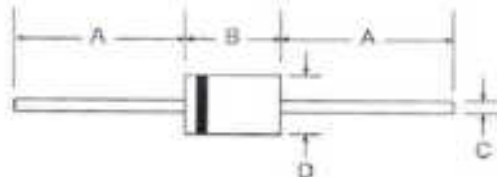

Mechanical Data

- Case: DO-41
- Case Material: Glass, UL Flammability Classification Rating 94V-0
- Terminals: Finish — Sn96.5Ag3.5. Solderable per MIL-STD-202, Method 208
- Polarity: Cathode Band
- Marking: Type Number
- Weight: 0.35 grams (approximate)

DO-41 Glass		
Dim	Min	Max
A	26.0	—
B	—	4.10
C	—	0.86
D	—	2.00
All Dimensions in mm		

Maximum Ratings @ $T_A = 25^\circ\text{C}$ unless otherwise specified

Characteristic	Symbol	Value	Unit
Zener Current (see Table page 2)	I_Z	P_d / V_Z	mA
Power Dissipation	P_d	1.0	W
Derate Above 50°C (Note 1)		6.67	mW/ $^\circ\text{C}$
Thermal Resistance - Junction to Ambient Air	$R_{\theta JA}$	175	$^\circ\text{C/W}$
Forward Voltage @ $I_F = 200\text{ mA}$	V_F	1.2	V
Operating and Storage Temperature Range	T_J, T_{STG}	-85 to +175	$^\circ\text{C}$

- Notes:
1. Valid provided that leads are kept at TL @ 50°C with lead length = 9.6mm (3/8") from case.
 2. EC Directive 2002/95/EC (RoHS) revision 13.3.2003. Glass and high temperature solder exemptions applied where applicable, see EU Directive Annex Notes 5 and 7.

OBSOLETE - PART DISCONTINUED

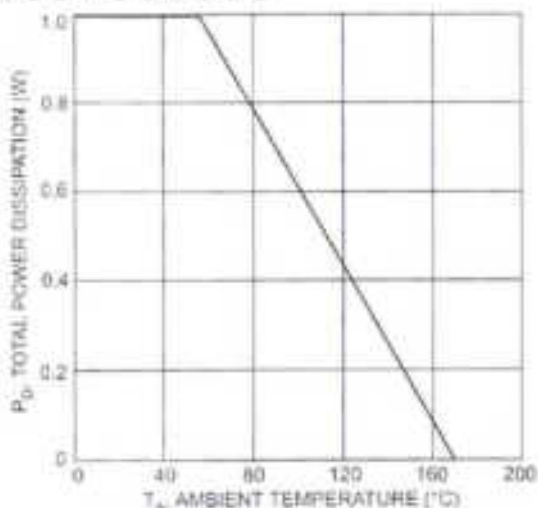

Fig. 1 Power Dissipation vs. Ambient Temperature

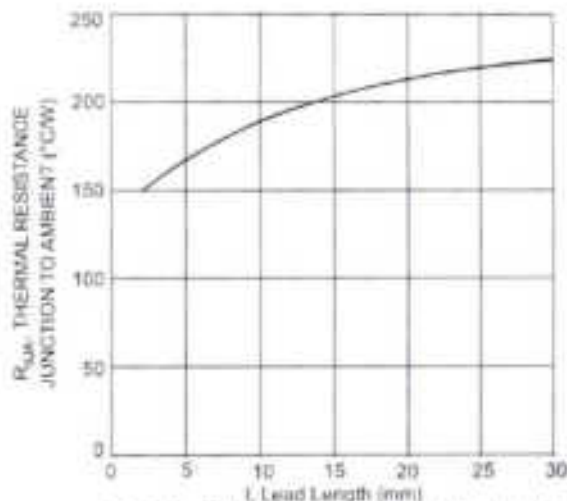

Fig. 2 Typical Thermal Resistance vs. Lead Length

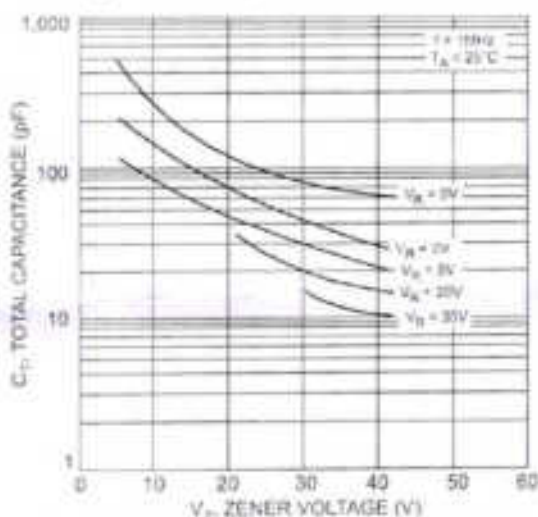

Fig. 3 Typical Total Capacitance vs. Zener Voltage

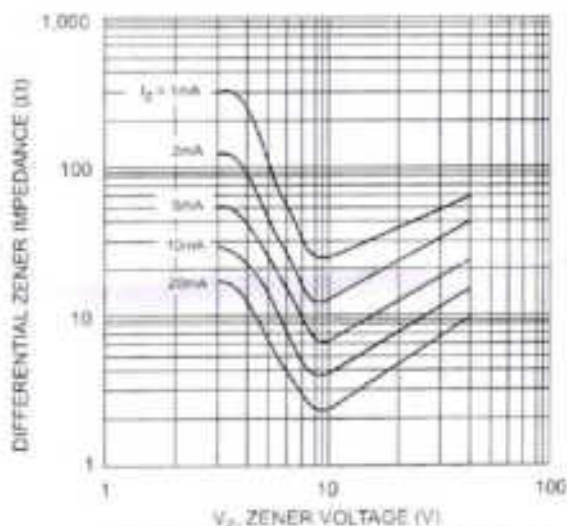

Fig. 4 Typical Zener Impedance vs. Zener Voltage

Ordering Information (Notes 5 & 6)

Device	Packaging	Shipping
(Type Number)-A*	DO-41 Glass	5K/ Ammo Pack
(Type Number)-T*	DO-41 Glass	5K/ Tape & Reel

- Notes: 5. *Add "-A" or "-T" to the appropriate type number in Electrical Characteristics Table. Example: 6.2V Zener = 1N4735A-A for ammo pack.
6. For packaging details, visit our website at <http://www.diodes.com/datasheet/ap02008.pdf>

IMPORTANT NOTICE

Diodes Incorporated and its subsidiaries reserve the right to make modifications, enhancements, improvements, corrections or other changes without further notice to any product herein. Diodes Incorporated does not assume any liability arising out of the application or use of any product described herein; neither does it convey any license under its patent rights, nor the rights of others. The user of products in such applications shall assume all risks of such use and will agree to hold Diodes Incorporated and all the companies whose products are represented on our website, harmless against all damages.

LIFE SUPPORT

Diodes Incorporated products are not authorized for use as critical components in life support devices or systems without the expressed written approval of the President of Diodes Incorporated.



www.vishay.com

TLUR6400, TLUR6401

Vishay Semiconductors

Universal LED in Ø 5 mm Tinted Diffused Package



16224

PRODUCT GROUP AND PACKAGE DATA

- Product group: LED
- Package: 5 mm
- Product series: standard
- Angle of half intensity: $\pm 30^\circ$

FEATURES

- For DC and pulse operation
- Luminous intensity categorized
- Standard T-1 1/2 package
- TLUR6400, without stand-offs
- Material categorization:
for definitions of compliance please see
www.vishay.com/doc?99912

APPLICATIONS

- General indicating and lighting purposes



RoHS
COMPLIANT
HALOGEN
FREE
GREEN
(100%)

PARTS TABLE

PART	COLOR	LUMINOUS INTENSITY (mcd)			at I_f (mA)	WAVELENGTH (nm)			at I_f (mA)	FORWARD VOLTAGE (V)			at I_f (mA)	TECHNOLOGY
		MIN.	TYP.	MAX.		MIN.	TYP.	MAX.		MIN.	TYP.	MAX.		
TLUR6400	Red	4	15	-	10	-	630	-	10	-	2	3	20	GaAsP on GaAs
TLUR6401	Red	4	15	32	10	-	630	-	10	-	2	3	20	GaAsP on GaAs

ABSOLUTE MAXIMUM RATINGS ($T_{amb} = 25^\circ\text{C}$, unless otherwise specified)

PARAMETER	TEST CONDITION	SYMBOL	VALUE	UNIT
Reverse voltage		V_R	6	V
DC forward current		I_F	20	mA
Surge forward current	$t_p \leq 10 \mu\text{s}$	I_{FSM}	1	A
Power dissipation	$T_{amb} \leq 65^\circ\text{C}$	P_V	60	mW
Junction temperature		T_j	100	$^\circ\text{C}$
Operating temperature range		T_{amb}	-40 to +100	$^\circ\text{C}$
Storage temperature range		T_{stg}	-55 to +100	$^\circ\text{C}$
Soldering temperature	$t \leq 5 \text{ s}$, 2 mm from body	T_{sol}	260	$^\circ\text{C}$
Thermal resistance junction to ambient		$R_{\theta JA}$	500	K/W

OPTICAL AND ELECTRICAL CHARACTERISTICS ($T_{amb} = 25^\circ\text{C}$, unless otherwise specified)

PARAMETER	TEST CONDITION	PART	SYMBOL	MIN.	TYP.	MAX.	UNIT
Luminous intensity (1)	$I_f = 10 \text{ mA}$	TLUR6400	I_v	4	15	-	mcd
		TLUR6401	I_v	4	15	32	mcd
Dominant wavelength	$I_f = 10 \text{ mA}$		λ_d	-	630	-	nm
Peak wavelength	$I_f = 10 \text{ mA}$		λ_p	-	640	-	nm
Angle of half intensity	$I_f = 10 \text{ mA}$		ϕ	-	± 30	-	$^\circ$
Forward voltage	$I_f = 20 \text{ mA}$		V_f	-	2	3	V
Reverse voltage	$I_R = 10 \mu\text{A}$		V_R	6	15	-	V
Junction capacitance	$V_R = 0 \text{ V}$, $f = 1 \text{ MHz}$		C_j	-	50	-	pF

Note

(1) In one packing unit $I_{vmin}/I_{vmax} \leq 0.5$

Rev. 2.1, 20-Sep-2021

For technical questions, contact: LED@vishay.com

Document Number: 63171

THIS DOCUMENT IS SUBJECT TO CHANGE WITHOUT NOTICE. THE PRODUCTS DESCRIBED HEREIN AND THIS DOCUMENT ARE SUBJECT TO SPECIFIC DISCLAIMERS, SET FORTH AT www.vishay.com/doc?9991000

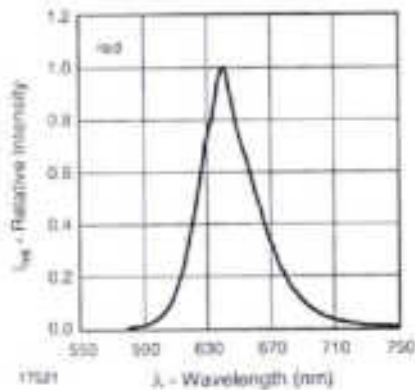
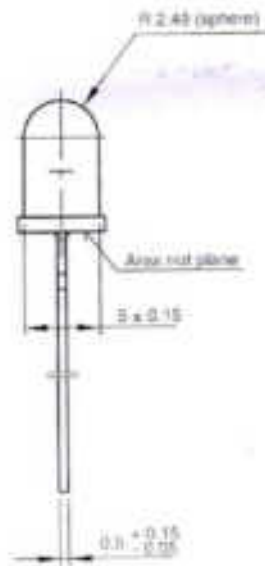
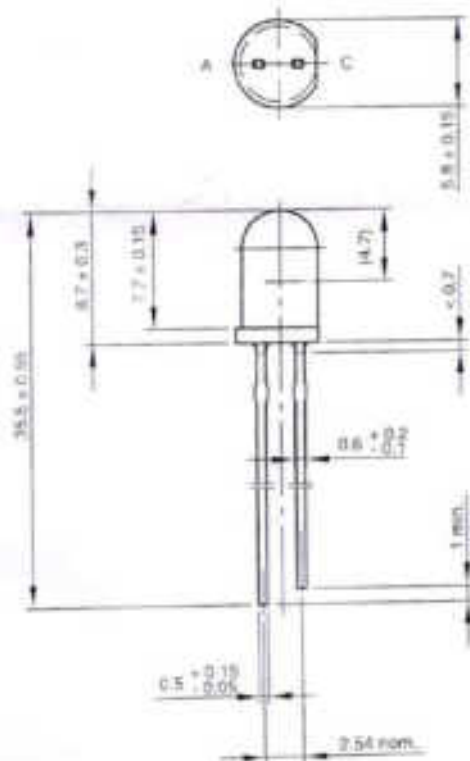

Fig. 7 - Relative Intensity vs. Wavelength

PACKAGE DIMENSIONS in millimeters



6 544 5229 02-4
Issue: 2: 19.05.06
01.10017





TYPICAL CHARACTERISTICS ($T_{amb} = 25\text{ }^{\circ}\text{C}$, unless otherwise specified)

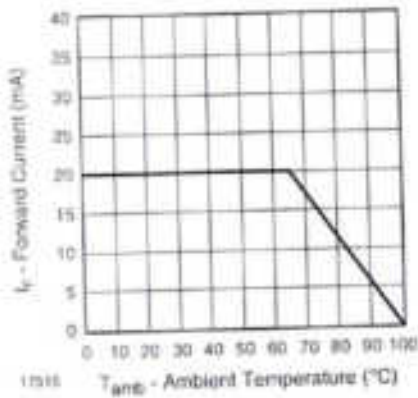

Fig. 1 - Forward Current vs. Ambient Temperature

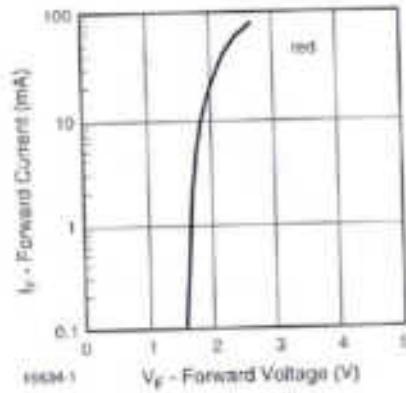

Fig. 4 - Forward Current vs. Forward Voltage

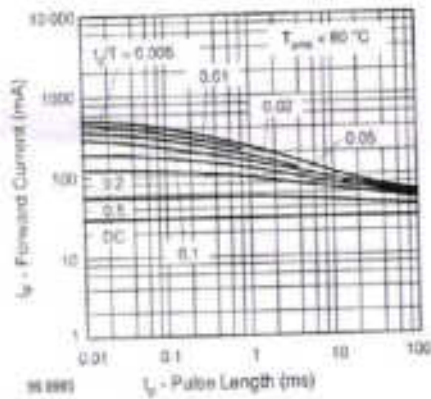

Fig. 2 - Pulse Forward Current vs. Pulse Duration

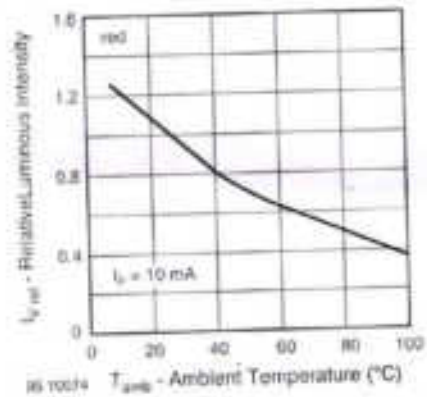

Fig. 5 - Relative Luminous Intensity vs. Ambient Temperature

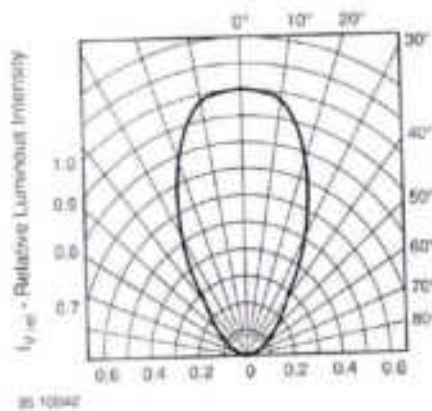

Fig. 3 - Relative Luminous Intensity vs. Angular Displacement

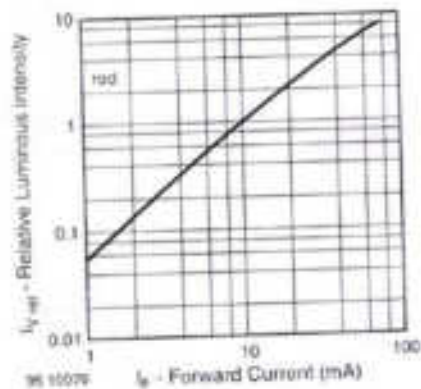

Fig. 6 - Relative Luminous Intensity vs. Forward Current



Electrical Characteristics @T_A = 25°C unless otherwise specified

Type Number	Nominal Zener Voltage (Note 3)	Test Current	Maximum Zener Impedance (Note 4)			Maximum Reverse Leakage Current		Max Surge Current 8.3ms	Temperature Coefficient @ I _{ZT}
	V _Z @ I _{ZT}	I _{ZT}	Z _{ZT} @ I _{ZT}	Z _{ZK} @ I _{ZK}	I _{ZK}	I _R	@ V _R	I _{ZS}	%/°C
	(V)	(mA)	(Ω)	(Ω)	(mA)	(μA)	(V)	(mA)	
1N4728A	3.3	75	10	400	1.0	100	1.0	1380	-0.08 to -0.05
1N4729A	3.6	69	10	400	1.0	100	1.0	1260	-0.06 to -0.05
1N4730A	3.9	64	9.0	400	1.0	50	1.0	1190	-0.07 to -0.02
1N4731A	4.3	58	9.0	400	1.0	10	1.0	1070	-0.07 to -0.01
1N4732A	4.7	53	8.0	500	1.0	10	1.0	970	-0.03 to +0.04
1N4733A	5.1	49	7.0	550	1.0	10	1.0	890	-0.01 to +0.04
1N4734A	5.6	45	5.0	600	1.0	10	2.0	810	0 to +0.045
1N4735A	6.2	41	2.0	700	1.0	10	3.0	730	+0.01 to +0.055
1N4736A	6.8	37	3.5	700	1.0	10	4.0	660	+0.015 to +0.06
1N4737A	7.5	34	4.0	700	0.5	10	5.0	605	+0.02 to +0.065
1N4738A	8.2	31	4.5	700	0.5	10	6.0	550	0.03 to 0.07
1N4739A	9.1	28	5.0	700	0.5	10	7.0	500	0.035 to 0.075
1N4740A	10	25	7.0	700	0.25	10	7.6	454	0.04 to 0.08
1N4741A	11	23	8.0	700	0.25	5.0	8.4	414	0.045 to 0.08
1N4742A	12	21	9.0	700	0.25	5.0	9.9	344	0.05 to 0.085
1N4743A	13	19	10	700	0.25	5.0	11.4	304	0.055 to 0.09
1N4744A	15	17	14	700	0.25	5.0	11.4	304	0.055 to 0.09
1N4745A	16	15.5	15	700	0.25	5.0	12.2	285	0.055 to 0.09
1N4746A	18	14	20	750	0.25	5.0	13.7	250	0.06 to 0.09
1N4747A	20	12.5	22	750	0.25	5.0	15.2	225	0.06 to 0.09
1N4748A	22	11.5	23	750	0.25	5.0	16.7	205	0.06 to 0.095
1N4749A	24	10.5	25	750	0.25	5.0	18.2	190	0.06 to 0.095
1N4750A	27	9.5	35	750	0.25	5.0	20.6	170	0.06 to 0.095
1N4751A	30	8.5	45	1000	0.25	5.0	22.8	150	0.06 to 0.095
1N4752A	33	7.5	45	1000	0.25	5.0	25.1	135	0.06 to 0.095
1N4753A	36	7.0	50	1000	0.25	5.0	27.4	125	0.06 to 0.095
1N4754A	39	6.5	60	1000	0.25	5.0	29.7	115	0.06 to 0.095
1N4755A	43	6.0	70	1500	0.25	5.0	32.7	110	0.06 to 0.095
1N4756A	47	5.5	80	1500	0.25	5.0	35.8	95	0.06 to 0.095
1N4757A	51	5.0	95	1500	0.25	5.0	38.8	90	0.06 to 0.095
1N4758A	56	4.5	110	2000	0.25	5.0	42.6	80	0.06 to 0.095
1N4759A	62	4.0	125	2000	0.25	5.0	47.1	70	0.06 to 0.095
1N4760A	68	3.7	150	2000	0.25	5.0	51.7	65	0.06 to 0.095
1N4761A	75	3.3	175	2000	0.25	5.0	56.0	60	0.06 to 0.095

Note: 3. Measured under thermal equilibrium and dc (I_{ZT}) test conditions.

4. The Zener impedance is derived from the 60 Hz ac voltage which results when an ac current having an rms value equal to 10% of the Zener current (I_{ZT} or I_{ZK}) is superimposed on I_{ZT} or I_{ZK}. Zener impedance is measured at two points to insure a sharp knee on the breakdown curve and to eliminate unstable units.

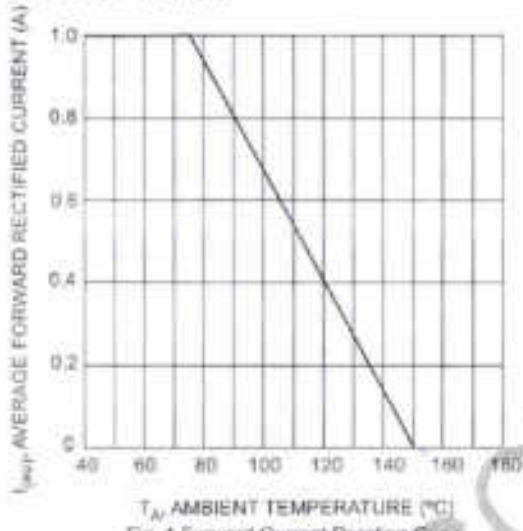

Fig. 1 Forward Current Derating Curve

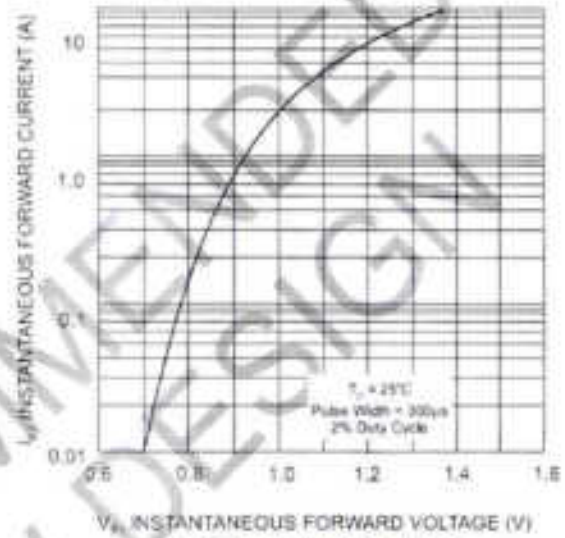

Fig. 2 Typical Forward Characteristics

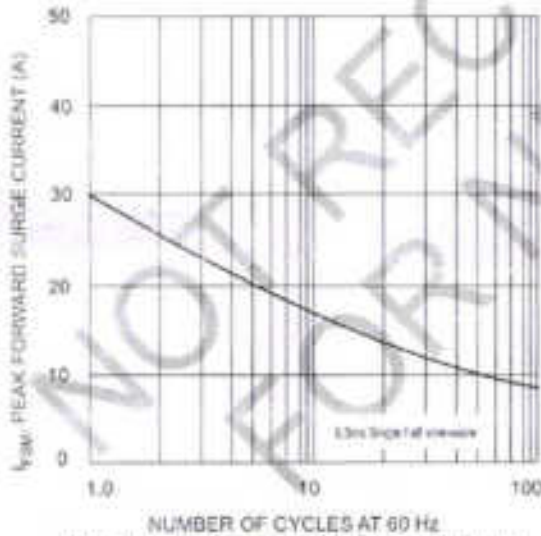

Fig. 3 Max Non-Repetitive Peak Fwd Surge Current

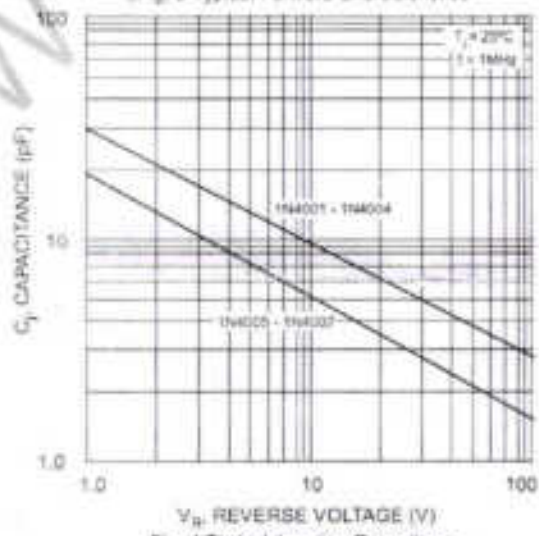

Fig. 4 Typical Junction Capacitance

Ordering Information (Note 4)

Device	Packaging	Shipping
1N4001-B	DO-41 Plastic	1K/Bulk
1N4001-T	DO-41 Plastic	5K/Tape & Reel, 13-inch
1N4002-B	DO-41 Plastic	1K/Bulk
1N4002-T	DO-41 Plastic	5K/Tape & Reel, 13-inch
1N4003-B	DO-41 Plastic	1K/Bulk
1N4003-T	DO-41 Plastic	5K/Tape & Reel, 13-inch
1N4004-B	DO-41 Plastic	1K/Bulk
1N4004-T	DO-41 Plastic	5K/Tape & Reel, 13-inch
1N4005-B	DO-41 Plastic	1K/Bulk
1N4005-T	DO-41 Plastic	5K/Tape & Reel, 13-inch
1N4006-B	DO-41 Plastic	1K/Bulk
1N4006-T	DO-41 Plastic	5K/Tape & Reel, 13-inch
1N4007-B	DO-41 Plastic	1K/Bulk
1N4007-T	DO-41 Plastic	5K/Tape & Reel, 13-inch

Note: 4. For packaging details, visit our website at <http://www.diodes.com/datasheets/ap02009.pdf>.



DHARAMPETH M. P. DEO MEMORIAL SCIENCE COLLEGE, NAGPUR

INTERNAL QUALITY ASSURANCE CELL (IQAC)

Activity Report

Date: 25th February 2023

Name of Organizing Department or Committee : Electronics Department

Name of the Activity : To study electrical characteristics of JFET using datasheet

Suggested CRITERION point if any : Suggested criteria II

Date of Activity : 25th February 2023

Place of Activity : Electronics Lab

Name of Guest Speaker/s or Judge/s or Chief Guest/s if any : Not applicable

Title of the Activity: To study electrical characteristics of JFET using datasheet

Based on Unit : 3(Paper I)

Class : Semester II

Number of Participants : 17

Name of the Teacher In-charge / Convener: Mrs. Leena P. Thakare

OUTCOME of the Activity with respect to mission vision of the institute and or academics:

Students studied the technical specifications and applications of BF245A, BF245B, BF245C using datasheet.

Prof. Pitambar Humane

CO ORDINATOR

INTERNAL QUALITY ASSURANCE CELL
DHARAMPETH, M. P. DEO MEMORIAL &
SCIENCE COLLEGE, NAGPUR

Dr. Varsha V. Rangari
Professor & Head
Head of the Department
Department of Electronics
Dharampeth M.P. Deo Memorial
Science College, Nagpur

Dr. Akhilesh Peshwe

Principal
Principal
Dharampeth M.P. Deo Memorial
Science College, Nagpur.



DHARAMPETH M. P. DEO MEMORIAL SCIENCE COLLEGE, NAGPUR

Department of Electronics

Semester II- (2022-23)

Activity (Paper I - Unit- 3)

Sr. No.	Student Name	Mobile Number	Email ID
1	Tannu Arun Varthi	9322044903	tannuvarthi@gmail.com
2	Khushbu Rajiv Pali	8459565214	palikhushbu59@gmail.com
3	Sandeep Rakesh Kumar Kumar	8081144948	sandeepk27900@gmail.com
4	Khushi Rajiv Pali	8767607224	palikhushi4@gmail.com
5	Aayushi Vikram Singh	9595119942	senxerox04@gmail.com
6	Vedant Onkar Umretkar	9049932753	umretkarvedant@gmail.com
7	Simran Narendra Dhimole	8390347026	mishralaxmi210@gmail.com
8	Harshata Gunderao Warkhede	9860432428	bandukeshao20@gmail.com
9	Tanu Ajay Singh	8806355808	tanusingh63492@gmail.com
10	Isha Ishwar Waghmare	8855919474	ishawaghmare9474@gmail.com
11	Tejas Rajesh Chelmeelwar	9604662119	tejaschelmeelwar@gmail.com
12	Kashish Kamalkumar Bisen	7887886117	kashishbisen05@gmail.com
13	Ved Sudhir Choudhary	7498572766	vedchoudhary.cs.749@gmail.com
14	Bhagyashali Dadarao Neware	7796434177	sakshineware2017@gmail.com
15	Monali Narendraji Shende	7796516257	shendemonali92@gmail.com
16	Vaidhavi Baburao Gongal	7507907278	gayatrigongal787@gmail.com
17	Abhishek Ravindra Singh	8208948107	abhi0882005@gmail.com

Name & Signature of Teacher In-Charge

Prof. Pitambar Humane
IQAC Coordinator

CO ORDINATOR
INTERNAL QUALITY ASSURANCE CELL
DHARAMPETH, M. P. DEO MEMORIAL &
SCIENCE COLLEGE, NAGPUR

Name & Signature of Head of the

Dr. Varad Peshwe
Professor & Head
Department of Electronics
Dharampeth M.P. Deo Memorial
Science College, Nagpur

Dr. Akhilesh Peshwe
Principal

Principal
Dharampeth M.P. Deo Memorial
Science College, Nagpur.

N-channel silicon field-effect transistors

BF245A; BF245B;
BF245C

FEATURES

- Interchangeability of drain and source connections
- Frequencies up to 700 MHz.

APPLICATIONS

- LF, HF and DC amplifiers.

DESCRIPTION

General purpose N-channel symmetrical junction field-effect transistors in a plastic TO-92 variant package.

CAUTION

The device is supplied in an antistatic package. The gate-source input must be protected against static discharge during transport or handling.

PINNING

PIN	SYMBOL	DESCRIPTION
1	d	drain
2	s	source
3	g	gate

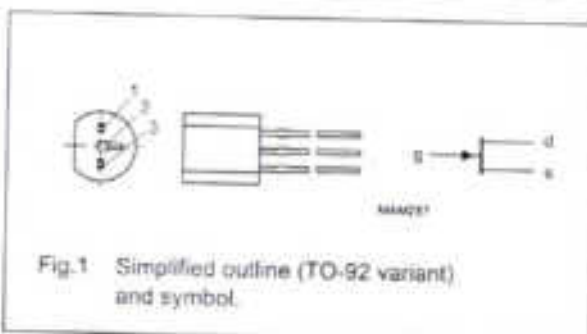

Fig.1 Simplified outline (TO-92 variant) and symbol.

QUICK REFERENCE DATA

SYMBOL	PARAMETER	CONDITIONS	MIN.	TYP.	MAX.	UNIT
V_{DS}	drain-source voltage		-	-	± 30	V
$V_{GS(off)}$	gate-source cut-off voltage	$I_D = 10 \text{ nA}$; $V_{DS} = 15 \text{ V}$	-0.25	-	-8	V
V_{GS0}	gate-source voltage	open drain	-	-	-30	V
I_{DSS}	drain current	$V_{DS} = 15 \text{ V}$; $V_{GS} = 0$				
	BF245A		2	-	6.5	mA
	BF245B		6	-	15	mA
	BF245C		12	-	25	mA
P_{tot}	total power dissipation	$T_{amb} = 75 \text{ }^\circ\text{C}$	-	-	300	mW
$ y_{fs} $	forward transfer admittance	$V_{DS} = 15 \text{ V}$; $V_{GS} = 0$; $f = 1 \text{ kHz}$; $T_{amb} = 25 \text{ }^\circ\text{C}$	3	-	6.5	mS
C_{tr}	reverse transfer capacitance	$V_{DS} = 20 \text{ V}$; $V_{GS} = -1 \text{ V}$; $f = 1 \text{ MHz}$; $T_{amb} = 25 \text{ }^\circ\text{C}$	-	1.1	-	pF

N-channel silicon field-effect transistors

BF245A; BF245B; BF245C

DYNAMIC CHARACTERISTICS

Common source; $T_{amb} = 25\text{ }^{\circ}\text{C}$; unless otherwise specified.

SYMBOL	PARAMETER	CONDITIONS	MIN.	TYP.	MAX.	UNIT
C_{is}	input capacitance	$V_{DS} = 20\text{ V}$; $V_{GS} = -1\text{ V}$; $f = 1\text{ MHz}$	-	4	-	μF
C_{rs}	reverse transfer capacitance	$V_{DS} = 20\text{ V}$; $V_{GS} = -1\text{ V}$; $f = 1\text{ MHz}$	-	1.1	-	μF
C_{os}	output capacitance	$V_{DS} = 20\text{ V}$; $V_{GS} = -1\text{ V}$; $f = 1\text{ MHz}$	-	1.6	-	μF
g_{is}	input conductance	$V_{DS} = 15\text{ V}$; $V_{GS} = 0$; $f = 200\text{ MHz}$	-	250	-	μS
g_{os}	output conductance	$V_{DS} = 15\text{ V}$; $V_{GS} = 0$; $f = 200\text{ MHz}$	-	40	-	μS
$ y_{fs} $	forward transfer admittance	$V_{DS} = 15\text{ V}$; $V_{GS} = 0$; $f = 1\text{ kHz}$	3	-	6.5	mS
		$V_{DS} = 15\text{ V}$; $V_{GS} = 0$; $f = 200\text{ MHz}$	-	6	-	mS
$ y_{rs} $	reverse transfer admittance	$V_{DS} = 15\text{ V}$; $V_{GS} = 0$; $f = 200\text{ MHz}$	-	1.4	-	mS
$ y_{os} $	output admittance	$V_{DS} = 15\text{ V}$; $V_{GS} = 0$; $f = 1\text{ kHz}$	-	25	-	μS
f_{gt}	cut-off frequency	$V_{DS} = 15\text{ V}$; $V_{GS} = 0$; $g_{fs} = 0.7$ of its value at 1 kHz	-	700	-	MHz
F	noise figure	$V_{DS} = 15\text{ V}$; $V_{GS} = 0$; $f = 100\text{ MHz}$; $R_G = 1\text{ k}\Omega$ (common source); input tuned to minimum noise	-	1.5	-	dB

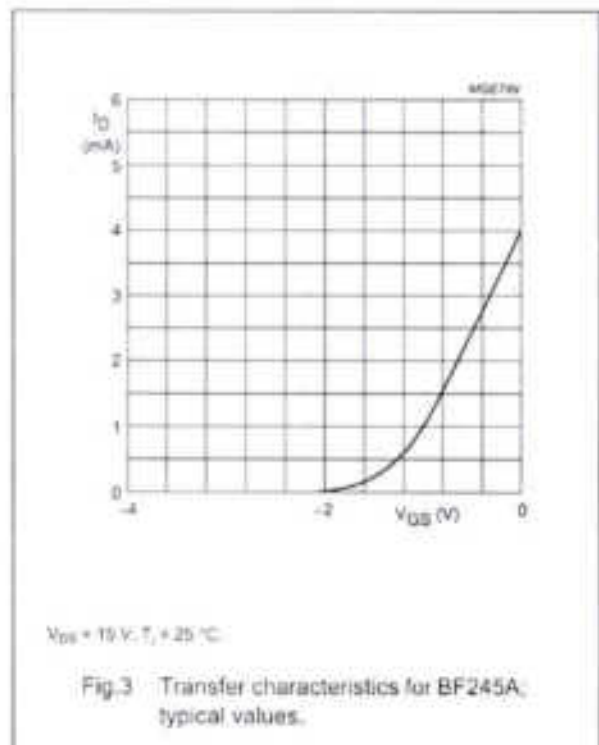
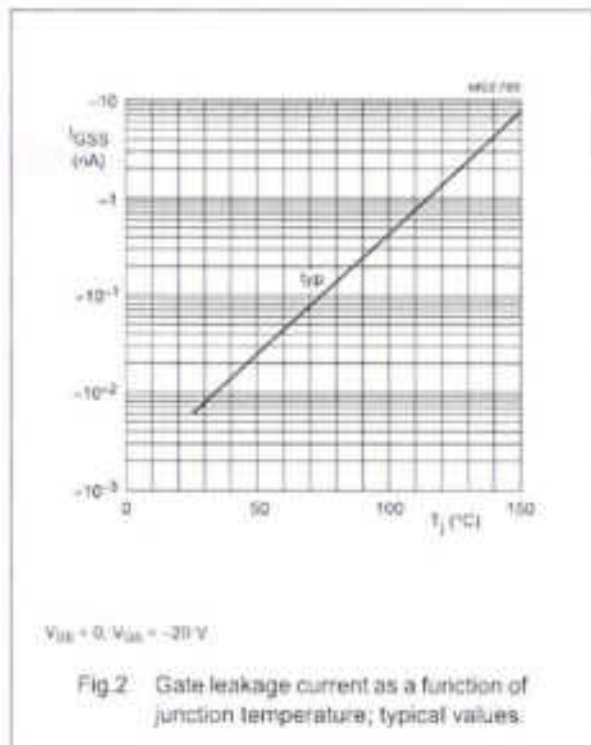

N-channel silicon field-effect transistors

BF245A; BF245B; BF245C

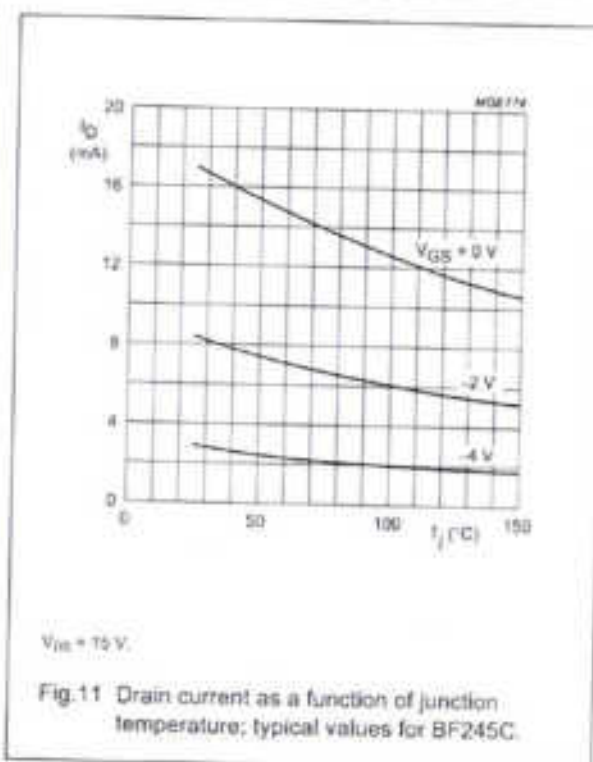
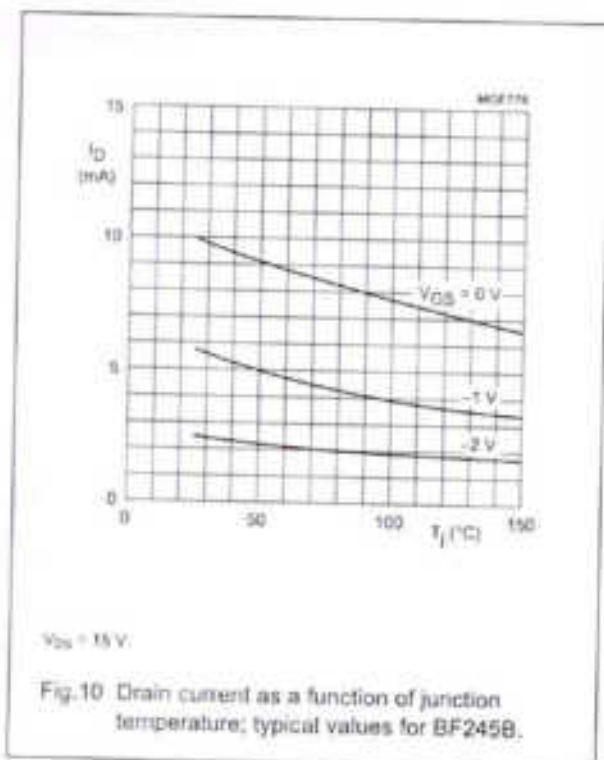
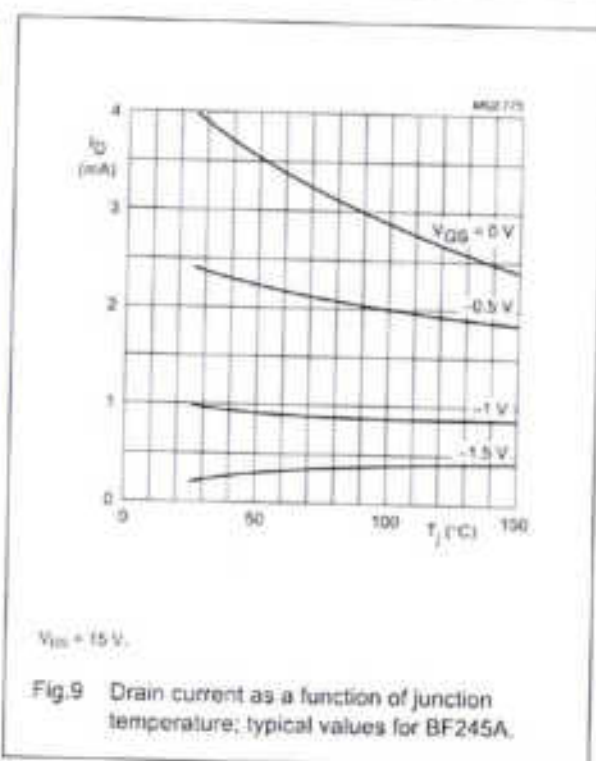
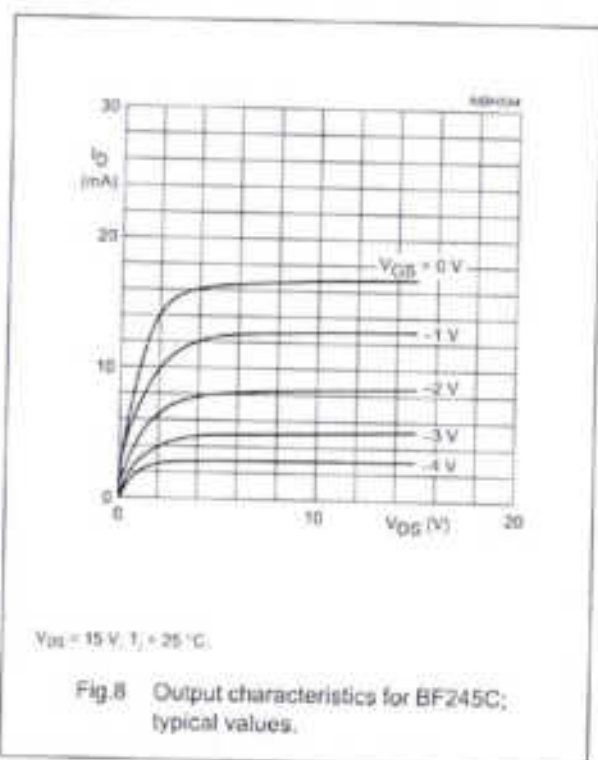

N-channel silicon field-effect transistors

BF245A; BF245B; BF245C

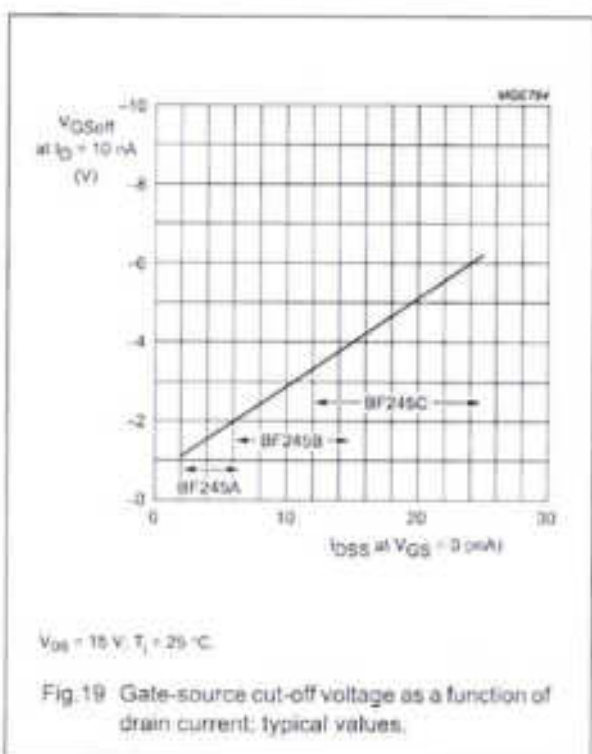
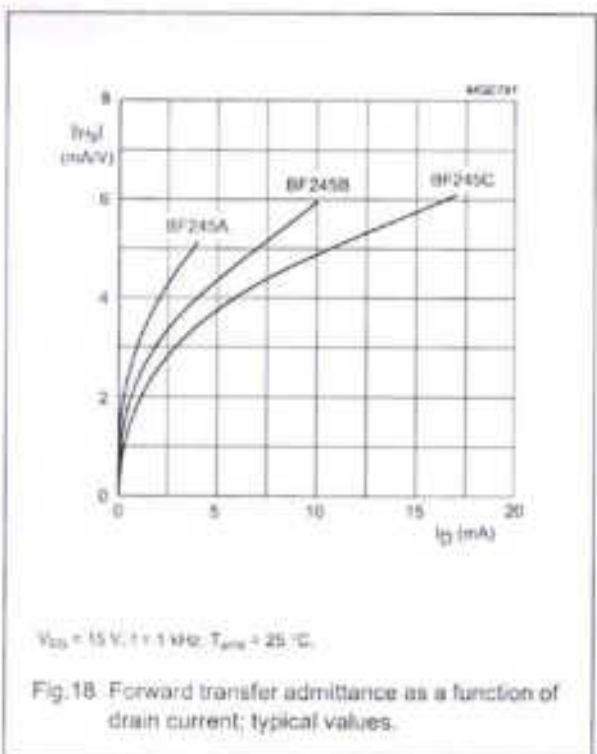
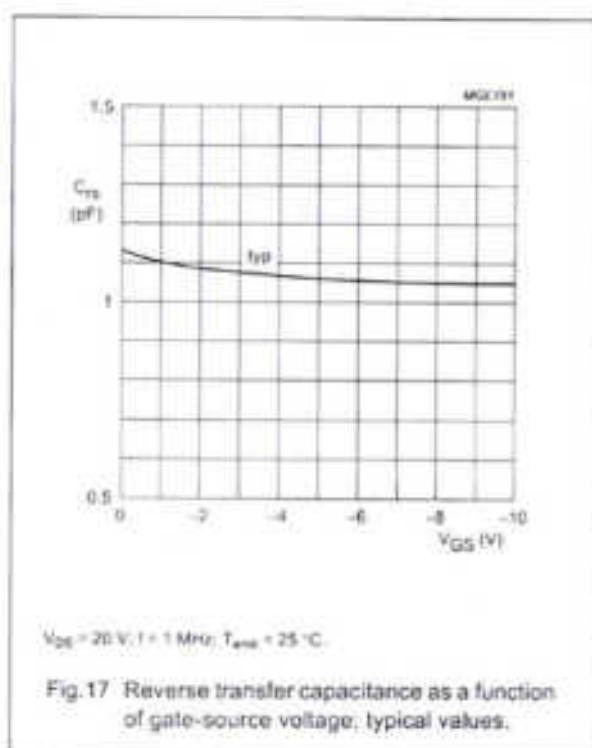
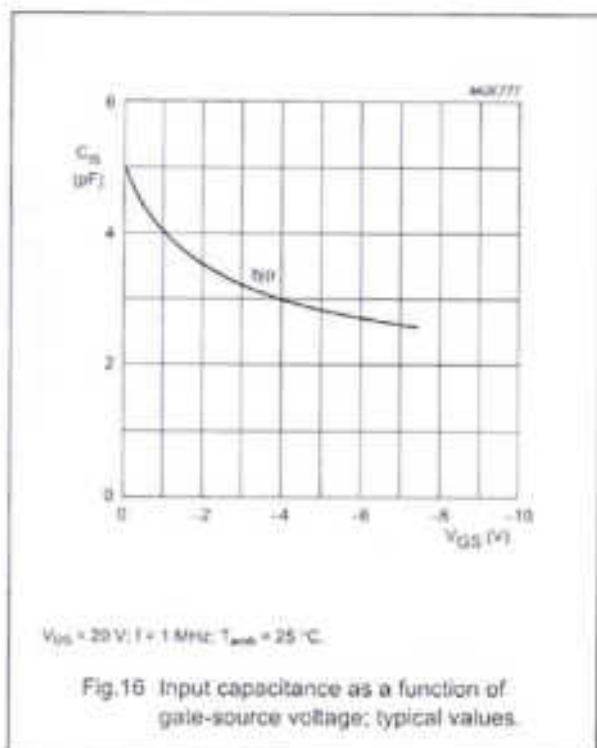

N-channel silicon field-effect transistors

BF245A; BF245B; BF245C

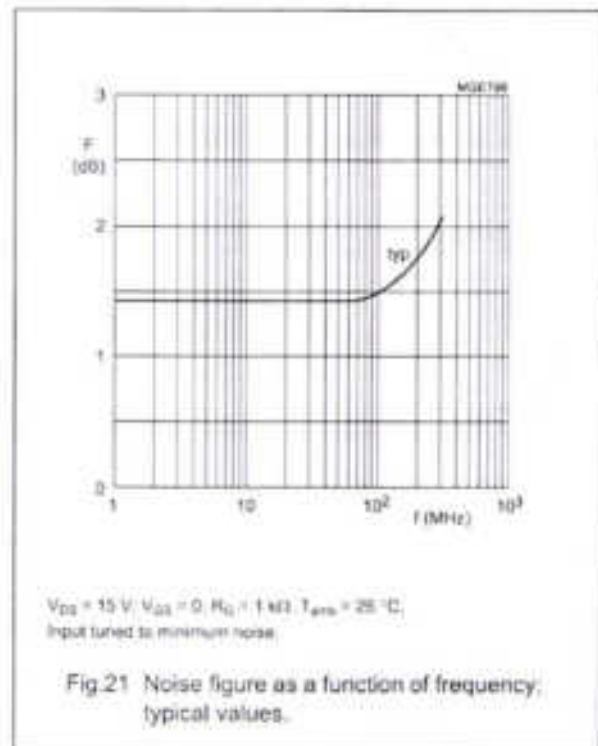
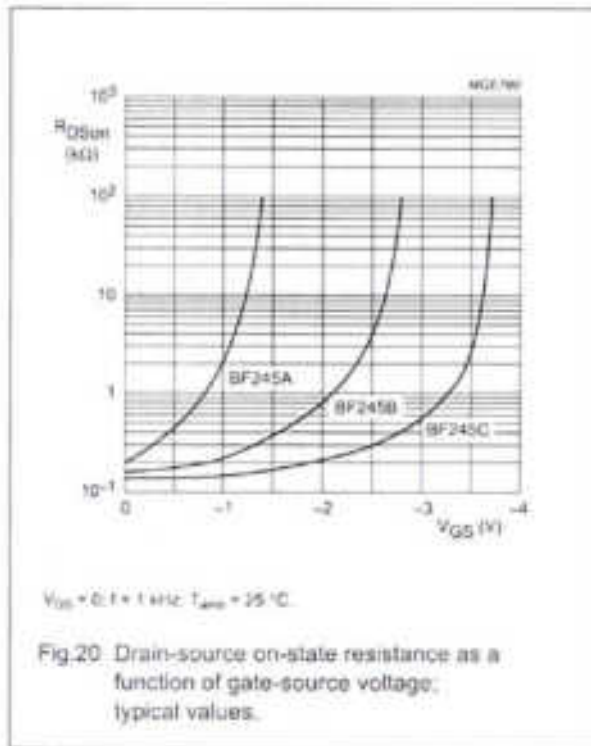

N-channel silicon field-effect transistors

BF245A; BF245B; BF245C

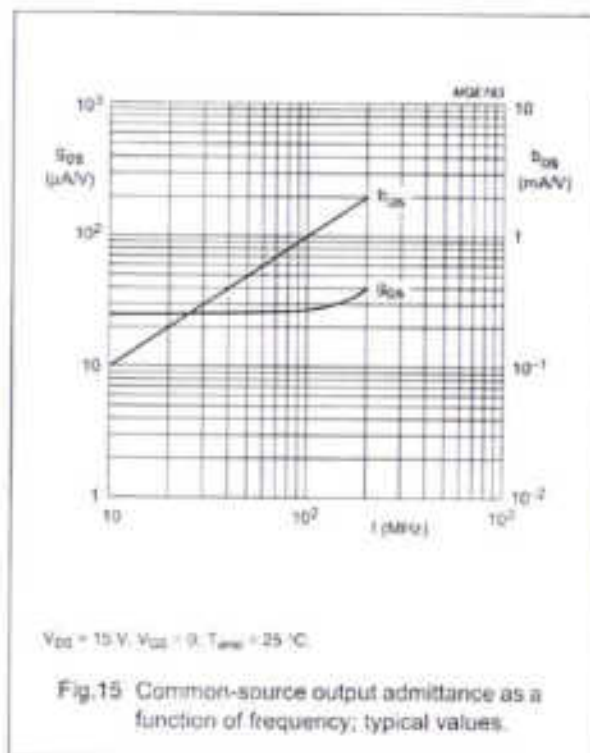
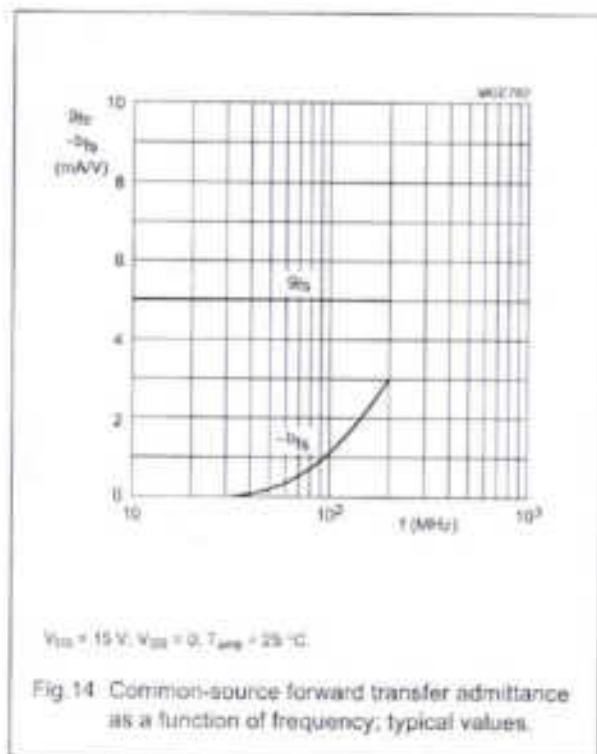
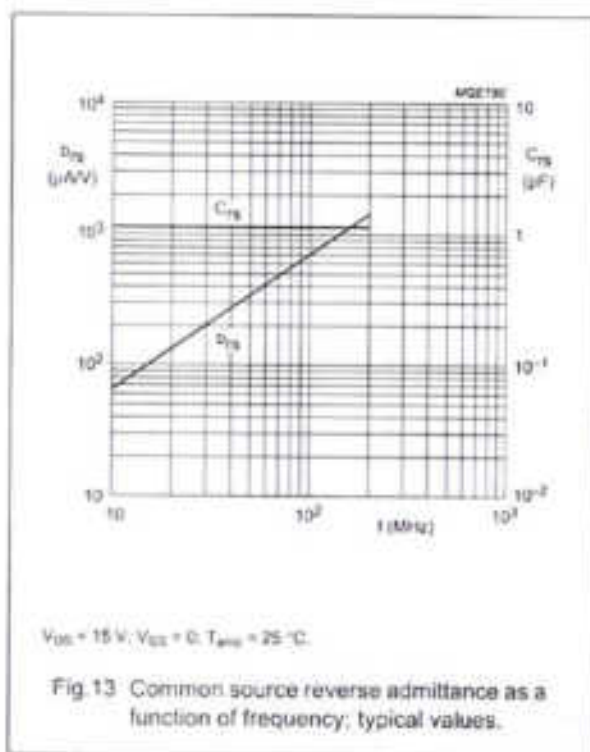
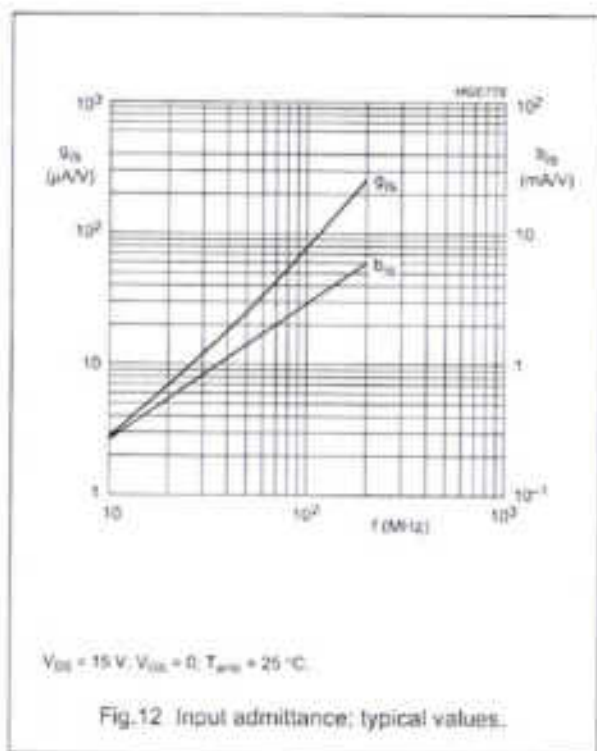

N-channel silicon field-effect transistors

BF245A; BF245B; BF245C

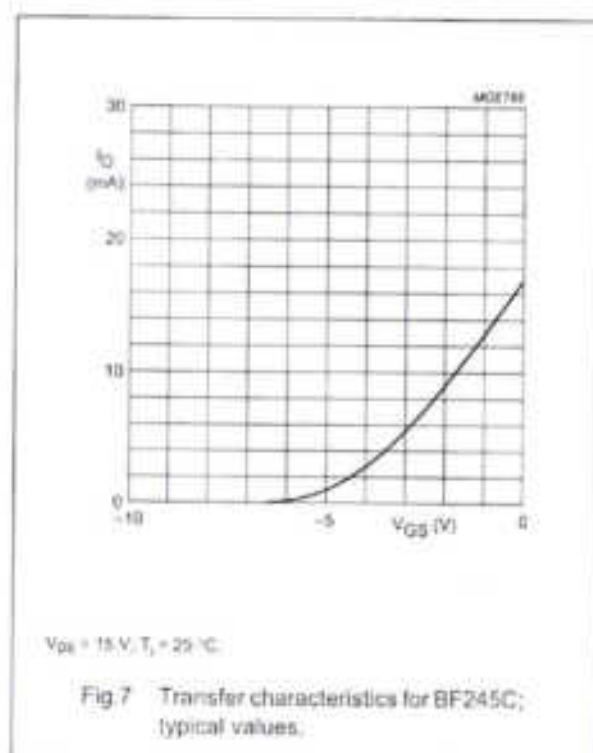
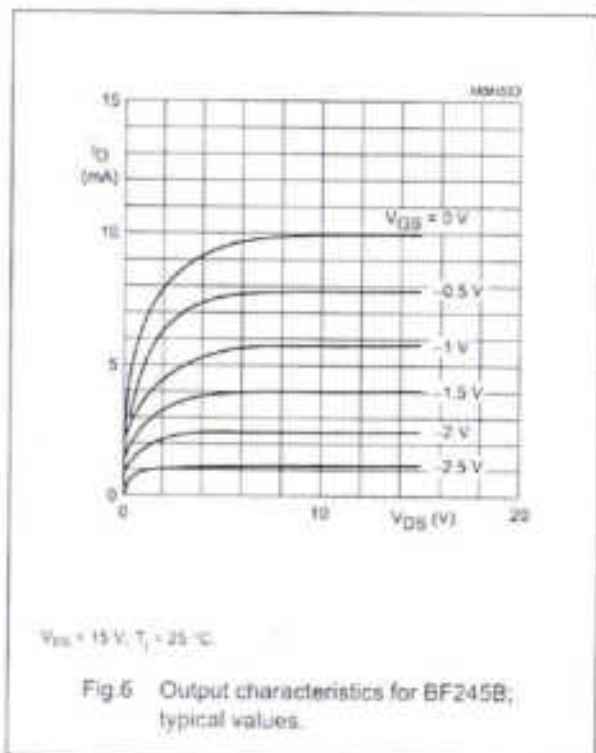
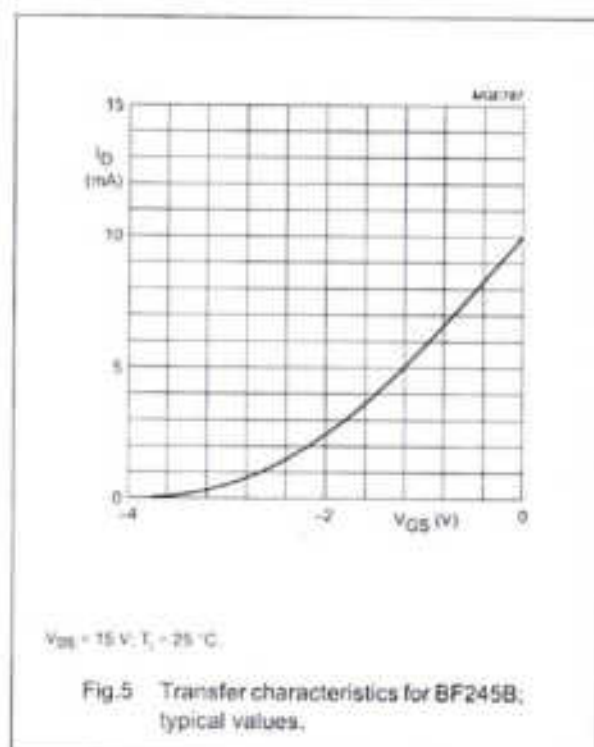
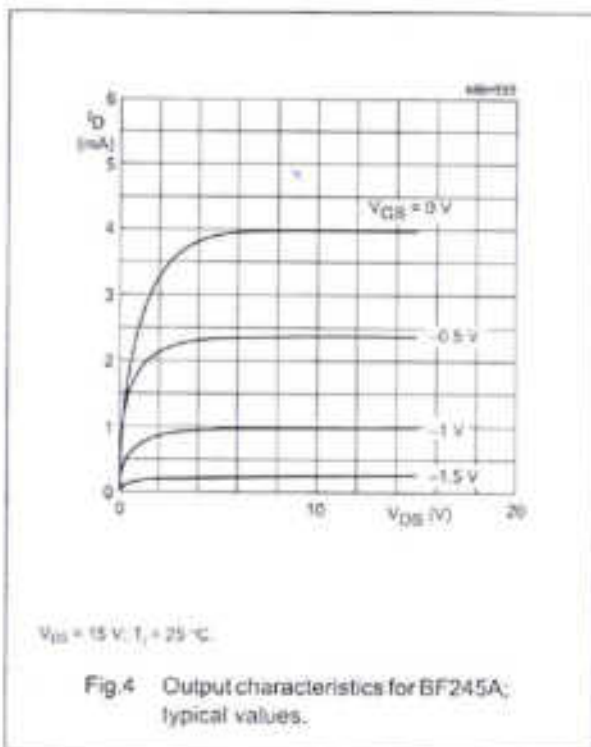

N-channel silicon field-effect transistors

BF245A; BF245B; BF245C

LIMITING VALUES

In accordance with the Absolute Maximum Rating System (IEC 134).

SYMBOL	PARAMETER	CONDITIONS	MIN.	MAX.	UNIT
V_{DS}	drain-source voltage		-	± 30	V
V_{GSD}	gate-drain voltage	open source	-	-30	V
V_{GSO}	gate-source voltage	open drain	-	-30	V
I_D	drain current		-	25	mA
I_G	gate current		-	10	mA
P_{tot}	total power dissipation	up to $T_{amb} = 75\text{ }^\circ\text{C}$;	-	300	mW
		up to $T_{amb} = 90\text{ }^\circ\text{C}$; note 1	-	300	mW
T_{stg}	storage temperature		-65	+150	$^\circ\text{C}$
T_j	operating junction temperature		-	150	$^\circ\text{C}$

Note

1. Device mounted on a printed-circuit board, minimum lead length 3 mm, mounting pad for drain lead minimum 10 mm \times 10 mm.

THERMAL CHARACTERISTICS

SYMBOL	PARAMETER	CONDITIONS	VALUE	UNIT
$R_{th(j-a)}$	thermal resistance from junction to ambient	in free air	250	K/W
	thermal resistance from junction to ambient		200	K/W

STATIC CHARACTERISTICS

 $T_j = 25\text{ }^\circ\text{C}$; unless otherwise specified.

SYMBOL	PARAMETER	CONDITIONS	MIN.	MAX.	UNIT
$V_{GS(BOSS)}$	gate-source breakdown voltage	$I_D = -1\text{ }\mu\text{A}$; $V_{DS} = 0$	-30	-	V
$V_{GS(OT)}$	gate-source cut-off voltage	$I_D = 10\text{ nA}$; $V_{DS} = 15\text{ V}$	-0.25	-8.0	V
V_{GS}	gate-source voltage	$I_D = 200\text{ }\mu\text{A}$; $V_{DS} = 15\text{ V}$	-0.4	-2.2	V
			-1.6	-3.8	V
			-3.2	-7.5	V
I_{DSS}	drain current	$V_{DS} = 15\text{ V}$; $V_{GS} = 0$; note 1	2	6.5	mA
			6	15	mA
			12	25	mA
I_{GSS}	gate cut-off current	$V_{DS} = -20\text{ V}$; $V_{GS} = 0$	-	-5	nA
		$V_{DS} = -20\text{ V}$; $V_{GS} = 0$; $T_j = 125\text{ }^\circ\text{C}$	-	-0.5	μA

Note

1. Measured under pulse conditions: $t_p = 300\text{ }\mu\text{s}$; $d \leq 0.02$.



DHARAMPETH M. P. DEO MEMORIAL SCIENCE COLLEGE, NAGPUR

INTERNAL QUALITY ASSURANCE CELL (IQAC)

Activity Report

Date: 23-01-2023

Name of Organizing Department or Committee: Department of Statistics.

Name of the activity: Compute the modal value of the binomial distribution with parameter.

Suggested CRITERION point if any:

Date of Activity: 23 Jan 2023

Place of Activity: Statistics lab

Name of Guest Speaker/s or Judge/s or Chief Guest/s if any:

Title of the Activity: Compute the modal value of the binomial distribution with parameter.

Number of Participants: 22

Name of the Teacher: Durga hingwe

Names of other Committee Members / Staff: N.A.

OUTCOME of the Activity with respect to mission vision of the institute and or academics:

Here we will learn about modal class, including what it is and how to find the modal class from a grouped frequency table. The value of mode provides an idea about the data set that appears the most.

Activity with newspaper coverage if any: No

Activity data save in PC of: Department of Statistics

Prof. Pitambar Humane
IQAC Coordinator

CO ORDINATOR
INTERNAL QUALITY ASSURANCE CELL
DHARAMPETH, M. P. DEO MEMORIAL &
SCIENCE COLLEGE, NAGPUR

Name & Signature of Teacher In-charge

Dr. Akhilesh Peshwe
Principal

Principal
Dharampeth M.P. Deo Memorial
Science College, Nagpur.



DHARAMPETH M. P. DEO MEMORIAL SCIENCE COLLEGE NAGPUR

8

Department of Statistics

Class: B.Sc. Sem.-II

NEP ACTIVITY

Paper - I

Unit - I

Name of the Teacher: Durga C. Hingwe

Date 23-01-23

Title of Activity: compute the modal value of the binomial distribution with parameter.

Sr. No.	Name of Student	Batch	Mobile No.	Email ID	Signature
01	Jarhi A. Kisanpore	F2	7058235243	jarhikisanpore@gmail.com	
02	pradnya B. Tispude	F2	5010362232	pradnyatispude9145@gmail.com	
3	Pranali V. Gupta	F2	7020069377	23991533@gmail.com	
4	Divyani Zagade	F2	9022866318	divyanizagade@gmail.com	
5	Vansha Tunkar	F2	9373650350	vanshatunkar48@gmail.com	
6	Sonia Niwal	F2	7058425021	niwalsonia70@gmail.com	
7	Veena Berikar	F2	9322016921	veenaberikar14@gmail.com	
8	Rutika Yadav	F2	8446085943	yadavarutika494@gmail.com	
9	Mohit Khurdkar	F	809328357	mohitkhurdkar@gmail.com	
10	Megha S. Ballav	F2/F1	9421728880	meghaballav04@gmail.com	
11	Utkarsha Ingale	F2	7499159175	utkarshaingale@gmail.com	
12	Nisha Kosavkar	F2	9890946645	nishakosavkar333@gmail.com	
13	Jahvi Joge	F2	7385060871	janhujoge08@gmail.com	
14	Jagruiti Fulkawar	F2	8767911307	jagruitifulkawar@gmail.com	
15	Janvi Khode	F2	7385066634	Janvikhode892@gmail.com	
16	Devashri Kakde	F2	9021344265	kakdedevashri@gmail.com	
17	Ishita Deshpande	F2	9130091540	ishitadeshpande21@gmail.com	
18	Sakshi Mishra	F2	8952988916	simishra3968@gmail.com	
19	Jahvi Laibey	F2	8446510539	jhavi laibey@gmail.com	
20	Vidya Lohi	F2	7020963219	vidyalohi@gmail.com	
21	Pranali Behankar	F2	8767581278	pdenha@gmail.com	
22	Navan N. Walthare	F1	7941870947	Navanwalthare40@gmail.com	

Signature of Teacher

Teacher in charge



DHARAMPETH M. P. DEO MEMORIAL SCIENCE COLLEGE, NAGPUR
INTERNAL QUALITY ASSURANCE CELL (IQAC)

Activity Report

Date: 30/01/2023

Name of Organizing Department or Committee: Chemistry

Name of the activity: Solid Waste Disposal Management (Student Centric)

Suggested CRITERION point if any: I

Date of Activity: 23/01/2023

Place of Activity: Ambazari Area

Name of Guest Speaker/s or Judge/s or Chief Guest/s if any: NO

Title of the Activity: Solid Waste Disposal Management

Number of Participants: 53

Name of the Teacher In-charge / Convener: Dr Vaishali Meshram

Names of other Committee Members / Staff:

OUTCOME of the Activity with respect to mission vision of the institute and or academics:

This activity is student centric, students get information about solid waste management, improper disposal of municipal waste can create unsanitary conditions, and these condition in turn can leads to pollution. They also pose a wide variety of administrative, economic, and social problems that must be managed and solved.

Activity with newspaper coverage if any: Nil

Activity data save in PC of: _Chemistry

Note: Kindly share geotag photographs separately along with report on igacdsc2022@gmail.com



Prof. Pitambar Humane
IQAC Coordinator
CO ORDINATOR
INTERNAL QUALITY ASSURANCE CELL
DHARAMPETH, M. P. DEO MEMORIAL &
SCIENCE COLLEGE, NAGPUR

Dr. Vaishali P. Meshram
Name & Signature of Teacher In-charge

Dr. Akhilesh Peshwe
Principal
Dharampeth M.P. Deo Memorial
Science College, Nagpur.



DHARAMPETH M. P. DEO MEMORIAL SCIENCE COLLEGE,
North Ambazari Road, Near Ambazari Lake, Nagpur- 440033

DATA VALIDATION & VERIFICATION (DVV)

Name of the Programme : Solid waste disposal Management
Date of the Programme : 23/01/2023
Name of Chief Guest if any : -
Name of Guest Speaker if any : -

Sr. No.	Name of the Participant	Mobile Number	E-mail Id	Signature
1	Nikhil. R. Raut	9022680159	rautn15541@gmail	
2	Ashlesha Sangole	9503998469	Ashlesha.Sangole94	
3	Dinesh Pauteti	9623389676	pautetidish51	
4	Aditya. B. Dalke	9028915776	dalkaditua2@gmail	
5	Dolly Sonkawade	9020628933	dollysonkawade99	
6	Janaki Rathode	7263819173	Janakirathode123@gmail	
7	Yukti Choudhary	9020953938	yukti.choudhary116@gmail	
8	Wilesh Hulke	8624091652	hulke.wilsh@gmail	
9	Jagruti A. Rawat	9265818046	Jagrutiagjitrawat5@gmail	
10	Muskan. R. Yadav.	9579492617	Muskanyadav1225@gmail	

Signature of
Programme In-charge

COORDINATOR
INTERNAL QUALITY ASSURANCE CELL
DHARAMPETH, M. P. DEO MEMORIAL
SCIENCE COLLEGE, NAGPUR

Principal
PRINCIPAL
Dharampeth M. P. Deo Memorial
Science College, Nagpur-440033



DHARAMPETH M. P. DEO MEMORIAL SCIENCE COLLEGE,
North Ambazari Road, Near Ambazari Lake, Nagpur- 440033

DATA VALIDATION & VERIFICATION (DVV)

11.	Shikha J. Yadav	7263881320	shikhayadav.54@gmail	
12.	Subbu R. Mishra	9860436418	subbumishra234@gmail	Subbu
13.	Ankita M Mishra	9421298176	mishraankita4683	Ankita
14.	Khushbu H. Choudhary	7262074960	khushbu@gmail.com	
15.	Vaishali R. Tiwari	8408027938	vaishalitiwari274@gmail	Vaishali
16.	Vaishali S. Patil	9322600647	vaishalipatil@gmail.com	Vaishali
17.	Devashri D. Biran	7773900643	DRBiran74@gmail.com	
18.	Dinesh Perreti	9623383676	perretidinesh57@gmail.com	
19.]	Abhishek Ashishkumar	9208302902	abhishe86@gmail.com	
20.]	Vaibhav Shinde	9080860782	vaibhavshinde57@gmail.com	V. A. Shinde
21.]	Sheepa Dhawale	9888264004	sheepadhawale111@gmail.com	Sheepa
22.]	Vamila Bandre	9370673867	bandrevamila.2000@gmail.com	Vamila
23.]	Pooja Itankar	9156973252	poojaitankar98@gmail.com	
24.]	Siddhanta Hishkane	9579092937	hishkane.siddhanta@gmail.com	
25.]	Rupesh Bhokre	9805887370	bhokrerupesh@gmail.com	

Signature of

Programme In-charge

IQAC COORDINATOR
INTERNAL QUALITY ASSURANCE CELL
DHARAMPETH, M. P. DEO MEMORIAL &
SCIENCE COLLEGE, NAGPUR

Principal
DHARAMPETH
Dharampeth M.P. Deo Memorial
Science College, Nagpur-440033



DHARAMPETH M. P. DEO MEMORIAL SCIENCE COLLEGE,
North Ambazari Road, Near Ambazari Lake, Nagpur- 440033

DATA VALIDATION & VERIFICATION (DVV)

26	Sakshi - S. Meshram	9145355733	sekshimeshram210@gmail.com	Sakshi
27	Mansi - F. Mate	816889807	mansi1918@gmail.com	Mansi
28	Rohit - A. Pawate	9973097285	pawate.rohit8@gmail.com	Rohit
29	Jyoti worker	7447366023	jyotiworker203@gmail.com	Jyoti
30	Juhi Choudhary	8669248944	choudharyjuhi120@gmail.com	Juhi
31	Chhakuli Wadikar	9325047907	chhakuliwadikar@gmail.com	Chhakuli
32	Tirra Bahangdale	9921776769	tirrabahangdale@gmail.com	Tirra Bahangdale
33	Vaishali Lakhe	8669594864	chhakuli.lakhe@gmail.com	Vaishali
34	Sumit S. Bandebuche	82788212339	sumitbandebuche100@gmail.com	Sumit
35	Vaishnavi S. Bedade	8657188093	vaishnavibedade100@gmail.com	Vaishnavi
36	Surabhi R. Pawde	7887516628	surabhipawde678@gmail.com	Surabhi
37	Kalpna Sunagpure	9579236712	kalpanasunagpure7@gmail.com	Kalpna
38	Jyoti Sharma	8669736380	jyoti58390@gmail.com	J. Sharma
39	Siddhesh Hirkan	9579092931	hirkanesiddhesh@gmail.com	Siddhesh
40	Mansi S. Fating	8767154686	mansifating110@gmail.com	Mansi
41	Khushi N. Suryawanshi	7972437504	khushisuryawanshi1189@gmail.com	Khushi

Signature of:

Program In-charge

CO-ORDINATOR
INTERNAL QUALITY ASSURANCE CELL
DHARAMPETH, M. P. DEO MEMORIAL &
SCIENCE COLLEGE, NAGPUR

Principal
DHARAMPETH M. P. DEO MEMORIAL
SCIENCE COLLEGE, NAGPUR-440033



DHARAMPETH M. P. DEO MEMORIAL SCIENCE COLLEGE,
North Ambazari Road, Near Ambazari Lake, Nagpur- 440033

DATA VALIDATION & VERIFICATION (DVV)

42	Jessaj D. Patilwal	9320820325	JessajPatilwal42@gmail.com Jessaj
43	Kavita Mishra	9657199261	kavita8309@gmail.com Kavita
44	Nupur Sharma	9322042259	nupursharma25@gmail.com Nupur
45	AMAN. A. DONGRE	770917312	amandongre2003@gmail.com Dongre
46	Doshara Madavi	8830146516	dosharamadavi@gmail.com Doshara
47	Kajal P. Nighat	9373250629	kajalnighat2000@gmail.com Kajal
48	Sania Raza	8975726700	midhalsania@gmail.com Sania
49	Divya Hanote	8605422901	divyahanote@gmail.com Hanote
50	Kavita Mishra	9657199261	ken723209@gmail.com Kavita
51	Shreya Chawale	8888264004	shreyachawale124@gmail.com Shreya
52	Urmila Bondre	9370673867	BondreUrmila2000@gmail.com Urmila
53	Vaibhavi Chunde	8080640782	VaibhaviChunde97@gmail.com Vaibhavi

Signature of

Programme In-charge

COORDINATOR
INTERNAL QUALITY ASSURANCE CELL
DHARAMPETH, M. P. DEO MEMORIAL &
SCIENCE COLLEGE, NAGPUR

Principal
PRINCIPAL

Dharampeth M.P. Deo Memorial
Science College, Nagpur-440033



DHARAMPETH M. P. DEO MEMORIAL SCIENCE COLLEGE, NAGPUR
INTERNAL QUALITY ASSURANCE CELL (IQAC)
NEP Activity Report

Date: 30/01/2023

Name of Organizing Department or Committee: Chemistry

Name of the activity: NEP Activity Report (Sem IV, paper II, Unit I)

Suggested CRITERION point if any: Criteria II

Date of Activity: 24/01/2023

Place of Activity: Department of Chemistry

Name of Guest Speaker/s or Judge/s or Chief Guest/s if any- Nil

Title of the Activity: Sampling of solids and identification

Number of Participants: 42

Name of the Teacher In-charge / Convener: Dr. Mrs. Mrudul R. Keskar

Names of other Committee Members / Staff: Dr. Mrs. V. P. Meshram

OUTCOME of the Activity with respect to mission vision of the institute and or academics: This is a student's centric activity. Crystal structure is obtained by attaching atoms, group of atoms or molecules. It is formed by constituent particles to produce symmetric patterns. Model making help students to understand the concept of repeating pattern of atomic structure called unit cell, which is a building block of crystal structure. They got the information about crystal structure and symmetry. They can differentiate between length, edges of principal axes and angle between the unit cell which are called as lattice constants.



Activity with newspaper coverage if any: Nil

Activity data saved in PC of: Chemistry Department

Prof. Pitambar Humane
IQAC Coordinator

CO ORDINATOR
INTERNAL QUALITY ASSURANCE CELL
DHARAMPETH, M. P. DEO MEMORIAL &
SCIENCE COLLEGE, NAGPUR

Name & Signature of Teacher In-charge
(Dr. Mrs. Mrudul R. Keskar)

Dr. Akhilesh Peshwe
Principal

PRINCIPAL
Dharampeth M.P. Deo Memorial
Science College, Nagpur-440033



DHARAMPETH M. P. DEO MEMORIAL SCIENCE COLLEGE,
North Ambazari Road, Near Ambazari Lake, Nagpur- 440033

DATA VALIDATION & VERIFICATION (DVV)

Name of the Programme : NEP Activity - Project - Model Making - Sampling of solids and Identification (B.Sc II Sem IV) Chemistry - Paper II on HI

Date of the Programme : 24-01-2023

Name of Chief Guest if any : —

Name of Guest Speaker if any : —

Sr. No.	Name of the Participant	Mobile Number	E-mail Id	Signature
1.	Vaishnavi T. Kapse	8983751089	vaishnavikapse05@gmail.com	Vaishnavi
2.	Pratiksha S. Navghare	8623033760	Pratiksha44@gmail.com	P.S. Navghare
3.	Nikita . S. Bhawe	9820812749	NikitaBhawe98@gmail.com	Nikita
4.	Vaibhav A. Malewar	8767838219	vaibhavamalewar@gmail.com	Vaibhav
5.	Kalyani C. Shahare	9307046378	Shahare Kalyani S. G@gmail.com	Kalyani
6.	Shital G. Bankal	7758055139	Shitalbankal22@gmail.com	S. G Bankal
7.	Sagar S. Bawane	9975460979	Sagarbawane637@gmail.com	S. Bawane
8.	Chirayu B. Dolat	8010135012	chirayudolat22@gmail.com	Chirayu
9.	AMAN . A . DONGRE	7709217312	amandongre12003@gmail.com	Amangre
10.	Sania A. Raja	8975726700	midhatsania@gmail.com	Sania
11.	Jyoti Sharma	8669736380	jyotis8370@gmail.com	J. Sharma
12.	Spandhita H. Kulkarni	9579092931	hiskarnesiddhika1234@gmail.com	Spandhita
13.	Juhi Chaudhari	8669248944	chaudharijuhi20@gmail.com	Juhi
14.	Jagruiti Dharmraj Warkar	7447366093	Jagruitiwarkar20@gmail.com	Jagruiti

Signature of: [Signature]
Programme In-charge

IQAC Coordinator

INTERNAL QUALITY ASSURANCE CELL
DHARAMPETH M. P. DEO MEMORIAL &
SCIENCE COLLEGE, NAGPUR

[Signature]
Principal
PRINCIPAL

Dharampeth M.P. Deo Memorial
Science College, Nagpur-440033



DHARAMPETH M. P. DEO MEMORIAL SCIENCE COLLEGE,
North Ambazari Road, Near Ambazari Lake, Nagpur-440033

DATA VALIDATION & VERIFICATION (DVV)

15.	Mansi Jshwar Mate	8468891807	Mansi19182@gmail.com	Mansi
16.	Sakshi Sudhikumar Meshram	9145355493	Sakshimeshram20@gmail.com	Sakshi
17.	Sureti Longadje	8390516517	Suretilongadje11@gmail.com	Sureti
18.	Vishakha Baburante	8329639834	Vishakhababurante@gmail.com	Vishakha
19.	Shreya Dhawale	8888264004	Shreyadhawale124@gmail.com	Shreya
20.	Urmila Bendre	9370673967	BendreUrmil02090@gmail.com	Urmila
21.	Vaibhavi Shinde	8080640782	vaibhavishinde99@gmail.com	Vaibhavi
22.	Aditya Dewkar	9028415776	adityadewkar21@gmail.com	Aditya
23.	Afina Sheikh (CBM)	8080083981	afinasheikh973@gmail.com	Ashikh
24.	Ketaki Kishor (CBM)	9112759066	KetakiKishor13@gmail.com	Ketaki
25.	Anushree Chandel (CBM)	9145631751	Anuchandel2001@gmail.com	Anushree
26.	Ankur Raut (CBM)	9767873447	ankuraut2003@gmail.com	Ankur
27.	Smriti Vaidya	8856908764		
28.	Uma Rahangdale (CZM)	9921716769	UmaRahangdale@gmail.com	Rahangdale
29.	Chhakti Wadkar (CZM)	9325047907	ChhaktiWadkar@gmail.com	Chhakti
30.	Vaishnavi Lakhe (CZM)	8669894864	chhakti.lakhe636@gmail.com	Lakhe
31.	Pooja Itankar (CZM)	9156975252	poojaitankar48987@gmail.com	Pooja
32.	Shital R. Kelzarkar (AM)	9373399793	ShitalKelzarkar@gmail.com	Shital
33.	Sejal R. Lakhargal	9028851168	SejalLakhargal@gmail.com	Sejal

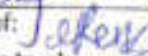
Signature of: 
Programme In-charge

IQAC Coordinator

INTERNAL QUALITY ASSURANCE CELL,
DHARAMPETH M. P. DEO MEMORIAL &
SCIENCE COLLEGE, NAGPUR

PRINCIPAL

Dharampeth M.P. Deo Memorial
Science College, Nagpur-440033



DHARAMPETH M. P. DEO MEMORIAL SCIENCE COLLEGE, NAGPUR
INTERNAL QUALITY ASSURANCE CELL (IQAC)
NEP Activity Report

Date: 25/01/2023

Name of Organizing Department or Committee: Chemistry Department

Name of the activity: NEP Activity Report (Sem- IV, Unit-I)

Suggested CRITERION point if any: Criteria II

Date of Activity: 24/01/2023

Place of Activity: Chemistry Department Laboratory

Name of Guest Speaker/s or Judge/s or Chief Guest/s if any: Nil

Title of the Activity: Demonstration of Coordination compounds and Double salts.

Number of Participants: 47

Name of the Teacher In-charge / Convener: Ms. Niharika A. Sute

Names of other Committee Members / Staff: Dr. Vaishali Meshram

OUTCOME of the Activity with respect to mission vision of the institute and or academics:

This is a student centric activity. In this Demonstration, students learnt that Coordination compounds & Double salts generally display a variety of distinctive physical and chemical properties such as colour, magnetic susceptibility, solubility and volatility, an ability to undergo oxidation-reduction reactions, and catalytic activity.



Activity with newspaper coverage if any: Nil

Activity data save in PC of: Chemistry Department

Note: Kindly share geotag photographs separately along with report on iqacdbc2022@gmail.com

Prof. Pitambar Humane
IQAC Coordinator

CO ORDINATOR
INTERNAL QUALITY ASSURANCE CELL
DHARAMPETH, M. P. DEO MEMORIAL &
SCIENCE COLLEGE, NAGPUR

(Niharika A. Sute)
Name & Signature of Teacher In-charge

Dr. Akhilesh Peshwe
Principal

PRINCIPAL
Dharampeth M.P. Deo Memorial
Science College, Nagpur-440033



DHARAMPETH M. P. DEO MEMORIAL SCIENCE COLLEGE,
North Ambazari Road, Near Ambazari Lake, Nagpur- 440033

DATA VALIDATION & VERIFICATION (DVV)

Name of the Programme : NEP Activity - 1 on unit-I, paper-I (Sem-IV)
Demonstration of Coordination Compounds & Double Salts

Date of the Programme : 24/01/2023

Name of Chief Guest if any : -

Name of Guest Speaker if any : -

Sr. No.	Name of the Participant	Mobile Number	E-mail Id	Signature
1)	Sagar S. Bawane	9975460979	sagarbawane62@gmail.com	S Bawane
2)	Chirayu B. Daloi	8010135012	chirayudaloi2006@gmail.com	B Daloi
3)	Uamila V. Bhande	9890673867	bhandevamila.2001@gmail.com	U Bhande
4)	Shreyas Dhasole	8888264004	shreyasdhasole124@gmail.com	S Dhasole
5)	AMAN. A. DONGRE	7709217312	amandongre2002@gmail.com	A Dongre
6)	SAMIR P. GHUMDE	9359236713	samirpghumde2002@gmail.com	S Ghumde
7)	Juhi S. Chaudhari	8669248944	chaudharijuhi12@gmail.com	Juhi
8)	Sakshi S. Meshram	9145355733	sakshimeshram210@gmail.com	S Meshram
9)	Jagruti D. Warkar	7447366023	jjagrutiwarkar09@gmail.com	J D Warkar
10)	Sureeti Longadge	8390516517	sureetilongadge11@gmail.com	S Sureeti

Signature of:

Programme In-charge

(Niharika A. Sute)

IQAC Coordinator

COORDINATOR
INTERNAL QUALITY ASSURANCE CELL
DHARAMPETH, M. P. DEO MEMORIAL &
SCIENCE COLLEGE, NAGPUR

Principal

PRINCIPAL
Dharampeth M.P. Deo Memorial
Science College, Nagpur-440033



DHARAMPETH M. P. DEO MEMORIAL SCIENCE COLLEGE,
North Ambazari Road, Near Ambazari Lake, Nagpur- 440033

DATA VALIDATION & VERIFICATION (DVV)

11)	Pratiksha S. Naughtare	8623033760	Pratiksha66@gmail.com	T.S. Naughtare
12)	Kalyani C. Shahare	9307046378	ShahareKalyani5@gmail.com	
13)	Shital G. Bankas	7758055139	Shitalbankas122@gmail.com	S.G. Bankas
14)	Vaishnavi Kapse	8983751089	vaishnavikapse05@gmail.com	Vaishnavi
15)	Vaibhav A. Malawani	8767838219	vaibhavamalawani73@gmail.com	
16)	Nikita . S. Bhawe	7820812749	nikitalbhawe38@gmail.com	Nikita
17)	Siddhant G. Hirkarne	9579092931	hirkarnesiddhant@gmail.com	
18)	Jyoti . J. Sharma	8669736980	jyotis8390@gmail.com	J. Sharma
19)	Sania Midhat A. Raja	8975726700	midhataria@gmail.com	S.Raja
20)	Darshana B. Madavi	8830146516	Darshanamadavi@gmail.com	
21)	ANIKET KUKADE	7741945323	Akukade66@gmail.com	
22)	Mansi Mode	8468891807	Mansi12181@gmail.com	
23)	Vaishnavi Nandhure.	9322439316	vaishnavi@gmail.com	
24)	Chhakuli Wadikar	9325047907	chhakuli15@gmail.com	
25)	Twinkal Lokhande	8149176609	Twinkal@gmail.com	
26)	Pooje Itankar	9156973252	poojeitankar377@gmail.com	

Signature of:

Programme In-charge

(Niharsika A. Sute)

IQAC Coordinator

CO ORDINATOR

INTERNAL QUALITY ASSURANCE CELL
DHARAMPETH, M. P. DEO MEMORIAL &
SCIENCE COLLEGE, NAGPUR

Principal

PRINCIPAL

Dharampeth M.P. Deo Memorial
Science College, Nagpur-440033



DHARAMPETH M. P. DEO MEMORIAL SCIENCE COLLEGE,

North Ambazari Road, Near Ambazari Lake, Nagpur- 440033

DATA VALIDATION & VERIFICATION (DVV)

27)	Kajal Tilakdhari Kaswad	7410763138	prasad.kajal2004@gmail.com	<u>Prasad</u>
28)	Riya Pandit	9870616853	panditriya753@gmail.com	<u>Riya</u>
29)	Anjali Anil Mishra	9825604513	anjalmishra4926@gmail.com	<u>Anjali</u>
30)	Shrawani Westhinde	7058368837	shrawanwesthinde20@gmail.com	<u>Shrawani</u>
31)	Rupesh Bhakre	8805887370	bhakrerupesh@gmail.com	<u>Rupesh</u>
32)	Nupur Sharma	9322042259	nupursharma@gmail.com	<u>Nupur</u>
33)	Divya Hanote	8605422901	divyahanote0406@gmail.com	<u>Divya</u>
34)	Mansi Raut	7385114937	Mansiraut431@gmail.com	<u>Mansi</u>
35)	Dhanashree Newalkar	9356516280	newalkardhanashree@gmail.com	<u>Dhanashree</u>
36)	Rajeshk Vishnawi Lakho	8669495859	rajeshkvisnawi@gmail.com	<u>Rajeshk</u>
37)	Shyamal D. Nuse	9765943998	shyamalnuse@gmail.com	<u>Shyamal</u>
38)	Sumit S. Bandebuche	8788012339	Sumitbandebuche10@gmail.com	<u>Sumit</u>
39)	Vaishnavi Gadge	9022976449	gadgewaishnavi@gmail.com	<u>Vaishnavi</u>
40)	Prajwal Bhojraj	8010434635	PrajwalB735@gmail.com	<u>Prajwal</u>
41)	Vedant Bany	8530455786	VedantBany2003@gmail.com	<u>Vedant</u>
42)	Vaishnavi J. Bedade	8657188093	Vaishnavibedade100@gmail.com	<u>Vaishnavi</u>

Signature of:

Programme In-charge

(Niharika A. Sute)

IQAC Coordinator

CO ORDINATOR

INTERNAL QUALITY ASSURANCE CELL
DHARAMPETH, M. P. DEO MEMORIAL &
SCIENCE COLLEGE, NAGPUR

Principal

PRINCIPAL

Dharampeth M.P. Deo Memorial
Science College, Nagpur- 440033



DHARAMPETH M. P. DEO MEMORIAL SCIENCE COLLEGE, NAGPUR
INTERNAL QUALITY ASSURANCE CELL (IQAC)

Activity Report

Date: 28/1/2023

Name of Organizing Department or Committee: 26th January 2023 committee

Name of the activity: Suggested CRITERION point if any: Criteria I

Date of Activity: 26/01/2023

Place of Activity: Dharampeth M. P. Deo Memorial Science College Nagpur

Name of Guest Speaker/s or Judge/s or Chief Guest/s if any: Lt. Shishir Patankar

Title of the Activity: Republic Day of India by Flag Hoisting 2023

Number of Participants: 56

Name of the Teacher In-charge / Convener: - Dr. Vaishali Meshram

Names of other Committee Members / Staff : : Lt. Dr. Prashant Ambekar, Dr. Rahul Kalode, Dr. Mansi Kanhe, Mrs. Priyanka Ganorkar and Mrs. B. S. Gurjar.

OUTCOME of the Activity with respect to mission vision of the institute and or academics:

Republic day celebrated successfully by all the staff members and students every year to remember the day when the constitution of India came into effect after India gained independence after a very long freedom struggle. A holistic environment was created in the college that reflects the unity, equality and liberty.

Activity with newspaper coverage if any: ----No

Activity data save in PC of: Chemistry



Prof. Pitambar Humane
IQAC Coordinator

CO ORDINATOR
INTERNAL QUALITY ASSURANCE CELL
DHARAMPETH, M. P. DEO MEMORIAL &
SCIENCE COLLEGE, NAGPUR

Name & Signature of Teacher In-charge

Dr. Akhilesh Peshwe
Principal

PRINCIPAL
Dharampeth M.P. Deo Memorial
Science College, Nagpur-440032



DHARAMPETH M. P. DEO MEMORIAL SCIENCE COLLEGE,
North Ambazari Road, Near Ambazari Lake, Nagpur- 440033

1

DATA VALIDATION & VERIFICATION (DVV)

Name of the Programme : Republic day of India by Flag Hoisting 2023
Date of the Programme : 26/01/2023
Name of Chief Guest if any : LT. Shishir Patankar
Name of Guest Speaker if any :

Sr. No.	Name of the Participant	Mobile Number	E-mail Id	Signature
1.	Damini M. Bondbuche	8275105785	bondbuchedamini@gmail.com	D Bondbuche
2.	Supriya Patil	7757871926	PatilSupriya@123@gmail.com	Patil
3.	Sayli Lokhande	9356413804	Sayalilokhande2910@gmail.com	S Lokhande
4.]	Ayushi Shukla	9373668043	ayushishukla2812002@gmail.com	A Shukla
5.]	Nikita Shebe	9021019101	nikitashebe2019@gmail.com	N Shebe
6.]	Aachal Wagh	9579643389	aachalwagh2003@gmail.com	A Wagh
7.]	Karishma Bansod	7389812507	karishmabansod2017@gmail.com	K Bansod
8.]	Nandini P. Paudyal	9769359885	nandini.paudyal@gmail.com	Nandini
9.]	Suhani Indurkar	9370419064	suhaniindurkar990@gmail.com	S Indurkar
10.]	Manali Shinde	7249637434	Manalishinde0062@gmail.com	M Shinde
11.]	Puanjali N. Gutkud	9130898362	guthwalpuanjali39@gmail.com	P Gutkud

Signature of:

Programme In-charge

IQAC Coordinator
CO ORDINATOR
INTERNAL QUALITY ASSURANCE CELL
DHARAMPETH, M. P. DEO MEMORIAL &
SCIENCE COLLEGE, NAGPUR

Principal
PRINCIPAL
Dharampeth M.P. Deo Memorial
Science College, Nagpur-440033



DHARAMPETH M. P. DEO MEMORIAL SCIENCE COLLEGE,
North Ambazari Road, Near Ambazari Lake, Nagpur- 440033

2

DATA VALIDATION & VERIFICATION (DVV)

12)	Ishwan Suryawanshi	8087357297	-	Ishwan
13)	Nikita Ekre	7972190515	-	Nikita
13)	Shivani Bhute	9302300209	-	Shivani
14)	Muskan Sheikh	8055474633	-	Muskan
15)	Sakshi Moon	7745827736	-	Sakshi
16)	Pallavi Bhogat	9022654940	-	Pallavi
17)	Ankita Bhoyat	8788031173	-	Ankita
18)	Isha Gupta	9373259849	-	Isha
19)	Aadesh Kulkarni	7517481162	-	Aadesh
20)	Laxmi Gaud	-	-	Laxmi
21)	Nandini Hadge	-	-	Nandini
22)	Tommy Chaudhari	860102941	-	Tommy
23)	Kavitha Adakha	8530597159	-	Kavitha
24)	Ishika Thakre	8010207069	-	Ishika
25)	Shruti Patil	95279887071	-	Shruti

Signature of:

Programme In-charge

IQAC Coordinator

CO ORDINATOR

INTERNAL QUALITY ASSURANCE CELL
DHARAMPETH M. P. DEO MEMORIAL
SCIENCE COLLEGE, NAGPUR

Principal

PRINCIPAL

Dharampeth M. P. Deo Memorial
Science College, Nagpur- 440033



DHARAMPETH M. P. DEO MEMORIAL SCIENCE COLLEGE,
North Ambazari Road, Near Ambazari Lake, Nagpur- 440033

3

DATA VALIDATION & VERIFICATION (DVV)

26)	Vaishnavi R. Chandekar	7249882904	vaishnavi.chandekar@gmail.com	Chandekar V
27)	Rani D. Patel	7888241794	Ranipatel69018.com	Rani..
28)	Asha sharmarao Landge	9322231581	ashalandge@coo@gmail.com	ashalandge
29)	Neha R. Khelwase	8766798940	nehu9002kk@gmail.com	Khelwase
30)	Rakhi P. Gedam	7378312504	gedam2000@gmail.com	R. Gedam
31)	Rani B. Katwale	9011247038	btanig12@gmail.com	R. Katwale
32)	Neha A. Waghade	7249895144	nehawaghade1650@gmail.com	N. Waghade
33)	Mrunali R. Sonsare	9850163812	Sonsaremrnzal16@gmail.com	M. Sonsare
34)	Krushnali S Kadi	8625854995	krushnali.kadi@gmail.com	K. Kadi
35)	Sakshi V. Chamate	7709204933	chamatesakshi@gmail.com	S. Chamate
36)	Shivani D. Wivedi	8855900546	Shivaniwivedi41@gmail.com	S. Wivedi
X 37)	Suraj S. Jadhav	8767135158	Suraj86jomsadon52@gmail.com	S. Jadhav
38)	Madhura Bhandare	8767484914	Madhurbhandare@gmail.com	M. Bhandare
39)	Rinam Wankhede	8010966529	wankhede.rinam@gmail.com	R. Wankhede
X 40)	Hrush H. Waghmare	9112959406	Hrushwaghmare@gmail.com	H. Waghmare
X 41)	Sanket Lade	7972086380	Sanketlade18@gmail.com	S. Lade

Signature of:

Programme in-charge

IQAC Coordinator
CO ORDINATOR

INTERNAL QUALITY ASSURANCE CELL
DHARAMPETH M. P. DEO MEMORIAL
SCIENCE COLLEGE, NAGPUR

Principal
PRINCIPAL

Dharampeth M. P. Deo Memorial
Science College, Nagpur-440033



DHARAMPETH M. P. DEO MEMORIAL SCIENCE COLLEGE,
North Ambazari Road, Near Ambazari Lake, Nagpur- 440033

4

DATA VALIDATION & VERIFICATION (DVV)

42)	Shivam Maurya	9607873702	-	Maurya
43)	Anshuman Sharma	9370892462	-	Anshuman
44)	Vishal Kumar Singh	9610787223	-	Vsingh
45)	Sonam M. Upadale	9890230462	-	Upadale
46)	Sushila S. Purti	7507439390	-	Purti
47)	Samiksha N. Kundekar	9145253758	-	Kundekar
48)	Samiksha Chaudhari	7517090406	-	Shoy
49)	Aishwarya Joshi	7498328662	-	Aishwarya
X50)	Peonam Chauragade	8467765121	-	Chauragade
51)	Shreyansh S. Naitkore	7447844189	-	Naitkore
52)	Anushka S. Wale	8530778433	-	Anushka
53)	Anushka R. Pali	7498102109	-	Pali
54)	Chaitali M. Burbade	9359540394	-	Chaitali
55)	Akanksha R. Yelufe	8767935524	-	Akanksha
56)	Anushka S. Das	7058933157	-	Das

Signature of:

Programme In-charge

IQAC Coordinator

CO ORDINATOR

INTERNAL QUALITY ASSURANCE CELL
DHARAMPETH, M. P. DEO MEMORIAL &
SCIENCE COLLEGE, NAGPUR

Principal

PRINCIPAL

Dharampeth M.P. Deo Memorial
Science College, Nagpur-440033



DHARAMPETH M. P. DEO MEMORIAL SCIENCE COLLEGE, NAGPUR
INTERNAL QUALITY ASSURANCE CELL (IQAC)

Activity Report (2022-23)

Date: 28/02/2023

Name of Organizing Department or Committee: Department of Physics

Name of the activity: Special workshop for Archers to learn the dynamics of the arrow

Suggested CRITERION point if any:

Date of Activity: 27-01-2023

Place of Activity: Sport Ground, Dharampeth M. P. Deo Memorial Science College, Nagpur

Name of Guest Speaker/s or Judge/s or Chief Guest/s if any: Lt. Dr. P. W. Ambekar

Title of the Activity: Special workshop for Archers to learn the dynamics of the arrow

Number of Participants: 7

Name of the Teacher In-charge / Convener: Lt. Dr. Prashant Ambekar

Names of other Committee Members / Staff: Ms. Pralisha Patil (Archery coach)

OUTCOME of the Activity with respect to mission vision of the institute and or academics:

On demand of the coach and little archers who are practicing on the Sport Ground of the Institute for getting acquainted with the knowledge associated with the Arrow Dynamics and possible faults the beginners does.

Lt. Dr. Prashant Ambekar from Department of Physics who is also an Associate NC officer and trained firer has initiated this activity to teach the dynamics of the arrow and minimizing the errors during the aim and release of arrow.

Activity with newspaper coverage if any: NA

Activity data save in PC of: Lt. Dr. P. W. Ambekar



Prof. P. G. Humane
COORDINATOR
INTERNAL QUALITY ASSURANCE CELL
DHARAMPETH, M. P. DEO MEMORIAL &
SCIENCE COLLEGE, NAGPUR

Lt. Dr. Prashant Ambekar

Name & Signature of Teacher In-charge

Dr. Akhilesh Peshwe

Principal
PRINCIPAL
Dharampeth M. P. Deo Memorial
Science College, Nagpur.



DHARAMPETH M. P. DEO MEMORIAL SCIENCE COLLEGE,
North Ambazari Road, Near Ambazari Lake, Nagpur- 440033

DATA VALIDATION & VERIFICATION (DVV)

Name of the Programme : Workshop on Arrow Dynamics for Archery Beginners
Date of the Programme : 27-01-2023
Name of Chief Guest if any : Lt. Dr. P. W. Ambekar & Ms. Pralisha Patil
Name of Guest Speaker if any : _____

Sr. No.	Name of the Participant	Mobile Number	E-mail Id	Signature
1.	Nitin P. Jadhav	7720993662		<u>NITIN</u>
2.	Anurag S. Kheekar	9356895248	<u>anuragkheekar11</u>	<u>Anurag</u>
3.	Ku. Ojashvi A. Sontakke	9975086026	-	<u>Ojashvi</u>
4.	Ku. Tanishtha A. Sontakke	-	-	<u>Tanishtha</u>
5.	Esther N. Kujur	8446535412	<u>EstherKujur@gmail</u>	<u>Esther</u>
6.	Tanmay Chondhari	8600102341	<u>tcheedkari8600@gmail.com</u>	<u>Tan</u>
7.	Karthik Mire	9604792402	<u>Karthikmire01@gmail.com</u>	<u>Karthik</u>
8.	Sachin Bantela	921091157	<u>Sachinoot@gmail.com</u>	<u>Sachin</u>
9.	Samyak Vithalkar	9763709916		<u>Samyak</u>
10.	Parth Gantam	9175051356		<u>Parth</u>

Signature of:

Programme In-charge

IQAC Coordinator
CO ORDINATOR
INTERNAL QUALITY ASSURANCE CELL
DHARAMPETH, M. P. DEO MEMORIAL &
SCIENCE COLLEGE, NAGPUR

Principal
PRINCIPAL
Dharampeth M. P. Deo Memorial
Science College, Nagpur.



DHARAMPETH M. P. DEO MEMORIAL SCIENCE COLLEGE, NAGPUR

INTERNAL QUALITY ASSURANCE CELL (IQAC)

Activity Report

Date: 30-01-2023

Name of Organizing Department or Committee: Department of Statistics.

Name of the activity: Mean and variance of geometric distribution with example of real life situation

Suggested CRITERION point if any:

Date of Activity: 30 Jan 2023

Place of Activity: Statistics lab

Name of Guest Speaker/s or Judge/s or Chief Guest/s if any:

Title of the Activity: Mean and variance of geometric distribution with example of real life situation

Number of Participants: 22

Name of the Teacher: Durga hingwe

Names of other Committee Members / Staff: N.A.

OUTCOME of the Activity with respect to mission vision of the institute and or academics:

The geometric distribution is a powerful tool in statistics and probability that allows us to understand the behaviour of a certain series of events.

Activity with newspaper coverage if any: No

Activity data save in PC of: Department of Statistics

Prof. Pitambar Humane
IQAC Coordinator

CO ORDINATOR
INTERNAL QUALITY ASSURANCE CELL
DHARAMPETH, M. P. DEO MEMORIAL &
SCIENCE COLLEGE, NAGPUR

Name & Signature of Teacher In-charge

Dr. Akhilesh Peshwe
Principal
Dharampeth M. P. Deo Memorial
Science College, Nagpur



DHARAMPETH M. P. DEO MEMORIAL SCIENCE COLLEGE NAGPUR

Department of Statistics

Class: B.Sc. Sem.-II

NEP ACTIVITY

Paper-I

Unit-II

Name of the Teacher: Durga C. Hingwe

Date 30-01-23

Title of Activity: Mean and variance of geometric distribⁿ with example of real life situation

Sr. No.	Name of Student	Batch	Mobile No	Email ID	Signature
1]	Varsha L. Turkar	F2	9373650950	varshaturkar488@gmail.com	<u>Turkar</u>
2]	Rutika Yadav	F2	8446085943	yadavrutika434@gmail.com	<u>Rutika</u>
3]	Sonia Niwal	F2	7058425021	niwalsonia70@gmail.com	<u>Niwal</u>
4]	Veena Borkar	F2	9322016921	veenaborkar4@gmail.com	<u>Veena</u>
5]	Janvi Kinnapure	F2	7058235243	janvikinnapure@gmail.com	<u>Kinnapure</u>
6]	Mohit Khadkekar	F2	8055329357	mohitkhadkekar@gmail.com	<u>Khadkekar</u>
7]	Pranali V. Gupta	F2	7020063397	29991539@gmail.com	<u>Gupta</u>
8]	Divyani V. Zagde	F2	9022866318	divyanizagde@gmail.com	<u>Zagde</u>
9]	Janvi Khode	F2	7385066634	janvikhode892@gmail.com	<u>Khode</u>
10]	Jagruti Julkawar	F2	8767911307	janvikulkawar@gmail.com	<u>Jagruti</u>
11]	Megha S. Ballav	F1	9421728880	meghaballav04@gmail.com	<u>M.S. Ballav</u>
12]	Shikha Deshpande	F2	9130091540	shikha.deshpande21@gmail.com	<u>Shikha</u>
13]	Utkarsha Ingole	F2	7499159178	utkarshaingole7@gmail.com	<u>Utkarsha Ingole</u>
14]	Devashi Kakde	F2	9021344265	kakdedevashi@gmail.com	<u>Devashi</u>
15]	Nisha Kosarkar	F2	9890996645	nishakosarkar333@gmail.com	<u>Nisha</u>
16]	Shikha Deshpande	F2			
16]	Sakshi Mishra	F2	9529889815	smishra39685@gmail.com	<u>Sakshi</u>
17]	Janvi Laibet	F2	8446510539	janviluibet@gmail.com	<u>Janvi</u>
18]	Janvi Joge	F2	7385060871	janvijoge8@gmail.com	<u>Janvi</u>
19]	Pradnya Tripathi	F2	8010362232	pradnyatripathi3115@gmail.com	<u>Pradnya</u>
20]	Pranali Behankar	F2	8767581278	pdenha@gmail.com	<u>Pranali</u>
21]	Nayan N. Walthe	F1	7841870947	Nayanwalthe@gmail.com	<u>Nayan</u>
22]	Vidya Lohi	F2	7020963219	vidyalohi@gmail.com	<u>Vidya</u>

Hingwe
Signature of Teacher

Hingwe
Teacher Incharge



DHARAMPETH M. P. DEO MEMORIAL SCIENCE COLLEGE, NAGPUR

INTERNAL QUALITY ASSURANCE CELL (IQAC)

Activity Report

Date: 31-01-2023

Name of Organizing Department or Committee: Department of Statistics.

Name of the activity: Finding sizes of type-I and types-II errors, Power of test of simple problem..

Suggested CRITERION point if any:

Date of Activity: 31st January 2023

Place of Activity: Statistics lab

Name of Guest Speaker/s or Judge/s or Chief Guest/s if any: N.A.

Title of the Activity: Finding sizes of type-I and types-II errors, Power of test of simple problem.

Number of Participants: 08

Name of the Teacher: Gauri Sinekar

Names of other Committee Members / Staff: N.A.

OUTCOME of the Activity with respect to mission vision of the institute and or academics:

The problem on finding size of type 1 and type 2 error was given to the students of B.Sc Sem 4. For solving this problem, student read and understand the question understand hypothesis and critical region which were given in question. Student revised the formula of size of type 1 and type 2 error and power of test. Student got knowledge about solving this type of particular problem.

Activity with newspaper coverage if any: No

Activity data save in PC of: Department of Statistics

Prof. Pitambar Humane
IQAC Coordinator

CO ORDINATOR
INTERNAL QUALITY ASSURANCE CELL
DHARAMPETH M. P. DEO MEMORIAL &
SCIENCE COLLEGE, NAGPUR

G. Sinekar
Name & Signature of Teacher In-charge

Dr. Akhilesh Peshwe
Principal

PRINCIPAL
Dharampeth M. P. Deo Memorial
Science College, Nagpur.



DHARAMPETH M. P. DEO MEMORIAL SCIENCE COLLEGE, NAGPUR

INTERNAL QUALITY ASSURANCE CELL (IQAC)

NEP Activity Report

Date:01/02/2023

Name of Organizing Department or Committee: Chemistry

Name of the activity: NEP Activity Report (Sem II, paper II, Unit I-Thermodynamics)

Suggested CRITERION point if any: Criteria II

Date of Activity: 31-01-2023

Place of Activity: Department of Chemistry

Name of Guest Speaker/s or Judge/s or Chief Guest/s if any- Nil

Title of the Activity: Model of closed and open system

Number of Participants: 64

Name of the Teacher In-charge / Convener: Dr. Mrs. Yogita Morey (Dahire)

Names of other Committee Members / Staff: Dr. Mrs. V. P. Meshram

OUTCOME of the Activity with respect to mission vision of the institute and or academics:

This is a student's centric activity. Model making for closed and open system helps students to understand the concept of closed and open system visually. The model showing closed and open system prepared by students describes the thermodynamical concept visually instead of theoretical studies. This can easily visualized and the students can understand the idea about open and closed system.



Activity with newspaper coverage if any: Nil

Activity data saved in PC of: Chemistry Department

Note: Kindly share Jio tag photographs separately along with report on iqacdisc2022@gmail.com

Prof. Pitambar Humane
IQAC Coordinator

Dr. Mrs. Yogita Morey (Dahire)
Name & Signature of Teacher In-charge

Dr. Akhilesh Peshwe
Principal

PRINCIPAL
Dharampeth M. P. Deo Memorial
Science College, Nagpur.



DHARAMPETH M. P. DEO MEMORIAL SCIENCE COLLEGE,
North Ambazari Road, Near Ambazari Lake, Nagpur- 440033

DATA VALIDATION & VERIFICATION (DVV)

Name of the Programme : NEP Activity (Sem II) Unit I (Thermodynamics)
Date of the Programme : Model of closed and open system
Name of Chief Guest if any : Date - 31-01-2023
Name of Guest Speaker if any : -

Sr. No.	Name of the Participant	Mobile Number	E-mail Id	Signature
1)	Monika I. Patel	7699225468	monikapatel7018@gmail.com	
2)	Shital O. Patle	9764596337	sp@12@gmail.com	
3)	Anjali R. Thakre	7866554821	thakreanjus81@gmail.com	
4)	Apeksha D. Ketangale	7559455794	apekshaketangale26@gmail.com	
5)	Lucky A Vishwakarma	9579660186	lvishwakarma09@gmail.com	
6)	Vaishnavi N. Tonge	8421657943	Vaishnutonge2004@gmail.com	
7)	Komalika S. Chaudhari	9322033866	Komalikachaudhari073@gmail.com	
8)	Pranali Y. Chavhare	9699654562	pranali@chavhare69@gmail.com	
9)	Yogita K. Thakre	9841021113	yogitathakre2584@gmail.com	
10)	Kalyani R. Sindram	82416539622	Sindramkalyani@gmail.com	

Signature of:

Programme In-charge

Dr. Yogita Morzy (Dahire)

IQAC Coordinator

CO ORDINATOR
INTERNAL QUALITY ASSURANCE CELL
DHARAMPETH M. P. DEO MEMORIAL &
SCIENCE COLLEGE, NAGPUR

Principal

PRINCIPAL
Dharampeth M.P. Deo Memorial
Science College, Nagpur-440033



DHARAMPETH M. P. DEO MEMORIAL SCIENCE COLLEGE,
North Ambazari Road, Near Ambazari Lake, Nagpur- 440033

DATA VALIDATION & VERIFICATION (DVV)

11)	Divya . Tagde	7380090176	Divya Tagde@gmail.com Divya Tagde
12)	Gunjan Bhoyar	7666799586	gunjanbhoyar04@gmail.com Gunjan
13)	Amisha Arakora	766659171	Amishararora@gmail.com Amisha
14)	Akansh Khobragade	7972228707	Akanshkhobragade@gmail.com Akansha
15)	Ashiya husain	9359259741	Ashiyahusain@gmail.com Ashiya
16)	Chanchal. K. Waghmare	7796016894	waghmarechanchal@gmail.com chanchal
17)	Priya Sharma	8010764349	priyasharma@gmail.com Priya
18)	Pohanshree Dhomne	9774900320	pohanshree@gmail.com Pohanshree
19)	Nisha Pandey	8605221390	Nishapandey@gmail.com Nisha
20)	Yashika Pandey	9156035297	yashika@gmail.com Yashika
21)	Krutika Pokale	9021533341	pokalekrutika@gmail.com Krutika
22)	Anvay. Borker	968538614	anvayborker9@gmail.com Anvay
23)	Khushi Rewade	8050923994	KhushiRewade@gmail.com Khushi
24)	Aakansha Maisal	8010923662	aakanshamaisal@gmail.com Aakansha
25)	Gauri Bhoyar	866835816	GauriBhoyar@gmail.com Gauri

Signature of:

Programme In-charge

Dr. Jagita Morey (Dahiro)

IQAC Coordinator

CO ORDINATOR
INTERNAL QUALITY ASSURANCE CELL
DHARAMPETH, M. P. DEO MEMORIAL &
SCIENCE COLLEGE, NAGPUR

Principal

PRINCIPAL

Dharampeth M. P. Deo Memorial
Science College, Nagpur-440033



DHARAMPETH M. P. DEO MEMORIAL SCIENCE COLLEGE,
North Ambazari Road, Near Ambazari Lake, Nagpur- 440033

DATA VALIDATION & VERIFICATION (DVV)

26	Shreya A. Jha	8983236002	Sangeetjha0303@gmail.com	stfs
27	Riya . Asingh	9595649831	riya0307@gmail.com	Riya
28	Gunjan J. Bhoyar	7666799586	gunjanbhoyar@gmail.com	Gunjan
29	Akansha Khobragade	7977228707	Akanshakhobragade@gmail.com	Akansha
30	Anshul Y. Kishnapure	9284067169	anshulkishnapure@gmail.com	Anshul
31)	Dhanashree newake	9359909913	Dhanashree@gmail.com	Aymail.com
32)	Nikhil Vishal Meshram	8767792960	nikhilmeshram@gmail.com	Anshul
33)	Nikhil Kumare	899040916	nikhilkumare@gmail.com	Anshul
34)	Pawan Thakore	8262969713	Pawanthakore@gmail.com	Anshul
35)	Ashiya husain	9859259741	Ashiyahusain@gmail.com	Ashiya
36)	Amisha Askar	7666559171	AmishaAskar@gmail.com	Amisha
37)	shruti charyekar	7720853263	shruticharyekar@gmail.com	
38)	Monika I. Patel	7499225468	MonikaPatel7038@gmail.com	mpatel
39)	Shital O. Patle	9764596387	s.p.12@gmail.com	@patle
20)	Pratibha B. Bhusani	7821048419	pbhusani718@gmail.com	PBB

Signature of:

Programme In-charge

Dr. Jogita Morey (Daheri)

IQAC Coordinator

CO ORDINATOR

INTERNAL QUALITY ASSURANCE CELL
DHARAMPETH, M. P. DEO MEMORIAL &
SCIENCE COLLEGE, NAGPUR

Principal

PRINCIPAL

Dharampeth M.P. Deo Memorial
Science College, Nagpur-440033



DHARAMPETH M. P. DEO MEMORIAL SCIENCE COLLEGE,
North Ambazari Road, Near Ambazari Lake, Nagpur-440033

DATA VALIDATION & VERIFICATION (DVV)

41	Shivam U. Patel	7038889083	sp040263@gmail.com	Shivam
42	Abhay thembhre	8975363145	Abhay230102@gmail.com	Abhay
43	nity Rai	+nity1419@gmail	.com - 705863891	Nity
44	Kastika Deshmukh	9694720960	Kastika.mds20@gmail.com	Kastika
45	Ritika Sonalkhya	9175381655	ritikawordhya@gmail.com	Ritika
46	Prayanshu R. Raut	9322725233	Prayanshuraut@gmail.com	Prayanshu
47	Yogitadenge	7058057240	Yogitadenge@gmail.com	Yogita
48	Ravindra Khadse	8007198273	ravindrakhadse@gmail.com	Ravindra
49	Azha Dhoke	9011681628	azhadhoke@gmail.com	Azha
50	Aparna Mohate	7020649887	Aparnamohate@gmail.com	Aparna
51	Vaidehi Thote	7558499191	vaidehitote27@gmail.com	Vaidehi
52	Umang Wairhi	9322928500	umangwairhi@gmail.com	Umang
53	Neha Wanjari	9373832266	nehawanjari73@gmail.com	Neha
54	Pranjali L. Meshram	7888080054	PranjaliMeshram85@gmail.com	Pranjali
55	Mrunali D. Bhilke	9322427616	MrunaliBhilke@gmail.com	Mrunali
56	Ankit patel	9970905638	Ankitpatel79727@gmail.com	Ankit
57	Siddhi Tiwari	8087143696	siddhitiwari21@gmail.com	Siddhi
58	Muskan Kulkarni	9156889239	muskanKulkarni30@gmail.com	Muskan
59	Ashwini R. Chaudhary	9699792732	chaudharyashwini28@gmail.com	Ashwini
60	Vaishali M. Sahasr	7972925603	VaishaliSahasr251@gmail.com	Vaishali
61	Khineshwar R. Pushptade	8624976072	Khineshwarpushptade@gmail.com	Khineshwar

Signature of:
Programme in-charge

Dr. Jogita Morey (Dahire)

IQAC Coordinator

CO ORDINATOR

INTERNAL QUALITY ASSURANCE CELL
DHARAMPETH, M. P. DEO MEMORIAL &
SCIENCE COLLEGE, NAGPUR

Principal

PRINCIPAL

Dharampeth M.P. Deo Memorial
Science College, Nagpur-440033



DHARAMPETH M. P. DEO MEMORIAL SCIENCE COLLEGE, NAGPUR
INTERNAL QUALITY ASSURANCE CELL (IQAC)

Activity Report

Date: 1-2-2023

Name of Organizing Department or Committee: Shekdar Committee

Name of the activity: Dr. Ashok Shekdar Memorial Intercollegiate PPT competition

Suggested CRITERION point if any: 1, 2 & 5

Date of Activity: 1-2-2023

Place of Activity: A.P. J. Abdul Kalam Hall

Name of Guest Speaker/s or Judge/s or Chief Guest/s if any: Mrs. Veena Shakdar and Mr. Ratnakar Kekatpure

Title of the Activity: Intercollegiate PPT competition

Number of Participants: 19

Name of the Teacher In-charge / Convener: Prof. Varsha Rangari

Names of other Committee Members / Staff: Dr. Prashant Ambekar, Dr. Nitin Gaikwad, Mr. Roshan Thakre, Mrs. Leena Thakre, Mrs. Ruma Kapre

OUTCOME of the Activity with respect to mission vision of the institute and or academics:

- The first prize of Rs. 2000/ was bagged by Mr. Akshay Bhatkulkar of Shivaji Science College, Nagpur.
- The second prize of Rs. 1000/ went to Ms. Vaishnavi Thakre of Shri Mathuradas Mohta science College Nagpur.
- The consolation prizes of Rs. 500/ was bagged by Mr. Shrutik Patil of K. R. Pandav Mahavidyalay, Nagpur.
- The Ashok Shekdar Memorial Rolling Trophy was bagged by the team of LAD College, Nagpur.

Activity with newspaper coverage if any: Yes

Activity data save in PC of: Prof V. V. Rangari



Note: Kindly share geotag photographs separately along with report on igacdsc2022@gmail.com

Prof. Pitambar Humane
IQAC Coordinator
CO ORDINATOR
INTERNAL QUALITY ASSURANCE CELL
DHARAMPETH, M. P. DEO MEMORIAL &
SCIENCE COLLEGE, NAGPUR

Name & Signature of Teacher in-charge

Dr. Akhilesh Peshwe
Principal
Principal
Dharampeth M.P. Deo Memorial
Science College, Nagpur.



DHARAMPETH M. P. DEO MEMORIAL SCIENCE COLLEGE

North Ambazari Road, Near Ambazari Lake, Nagpur-33

1st February 2023

DR. ASHOK SHEKDAR MEMORIAL INTER-COLLEGIATE POWER POINT PRESENTATION COMPETITION

List of Registered Students

Sr. No.	Name of student	Name of College	Class	Topic	Contact No.	Mail Id	Signature	Paid
1	Janhavi Shrikant Lambe	Department of Electronics & Computer Science RTMNU	M.Sc	Artificial Intelligence: Boon or Bane	7498656304	lambejanhavi19@gmail.com		<u>Paid</u>
2	Dipika Dilip Gawande	Department of Electronics & Computer Science RTMNU	M.Sc	Information Technology: Boon or Bane to Society	8407905085	deepikagawande2018@gmail.com		<u>Paid</u>
3	Shayon Kundu	Dr. Ambedkar College Nagpur		Artificial intelligence : boon and bane	7218422960	shayon.kundu404@gmail.com		<u>Paid</u>
4	Rohit GaribdasNade	Dr. Ambedkar College Nagpur		Artificial intelligence : boon and bane	9552578855	rohitnade646@gmail.com		



CO ORDINATOR
INTERNAL QUALITY ASSURANCE CELL
DHARAMPETH, M. P. DEO MEMORIAL &
SCIENCE COLLEGE, NAGPUR

Principal
Dharampeth M. P. Deo Memorial
Science College, Nagpur.

5	Aditya Krishna Ruikar	Dr. Ambedkar College Nagpur	Artificial intelligence : boon and bane	7620308863	adityaruikar20@gmail.com		
6	PALLAVI GANESH MIRASHE	DHARAMPETH MP DEO SCIENCE MEMORIES COLLAGE NAGPUR	MATHEMATICS IN EVERYDAY LIFE	9673424063	pallavimirashe100@gmail.com	Drishya (18)	Paid
7	Gaurav patel	Hislop college nagpur	Artificial intelligence:Boon and Bane	6394601102	gaurav.sk.patel@gmail.com		
3	Aishwarya Pradip Titarmore	J.M. Patel Art, Commerce and Science college, Bhandara	Genetically modified fruit	8421763828	at16092003@gmail.com		
9	Praptipatle	K R PandavMahavidyalay	Artificial Intelligence : Boon or Bane	8788332697	praptipatle321@gmail.com	Prapti (6)	Paid
10	Shrutik Patil	K R PandavMahavidyalay	I. Information Technology : Boon or Bane to Society	8788264112	patilshrutik500@gmail.com	Shrutik (13)	Paid
11	Yadneshchandras nekharhedase	K R PandavMahavidyalay	Artificial Intelligence : Boon or Bane	8010223981	yadneshhe829@gmail.com		

Dongale

Dr. P.
CO ORDINATOR
INTERNAL QUALITY ASSURANCE CELL
DHARAMPETH, M. P. DEO MEMORIAL &
SCIENCE COLLEGE, NAGPUR

Dr. P.
Principal
Dharampeth M. P. Deo Memorial
Science College, Nagpur

12	Vaibhav Nandkishor Mendwade	Mathurdasmohita science college		Artificial intelligence: Boon or Bane	8830482456	vaibhavnm123@gmail.com	Abhis (2)	Paid
13	Vedantsanjaykan here	K.R. PandavMahavidyalay		Artificial Intelligence : Boon or Bane	90215 16452	Vedantkanhere555@gmail.co.	Vedant (2)	Paid
14	Tanishka Saraf	Kamla Nehru mahavidyalaya	X	Artificial intelligence: boon or bane	9325371225	Tanishka.saraf18@gmail.com		
15	Afifa Khan	Kamla Nehru Mahavidyalaya	NR	Artificial Intelligence : Bone or Bane	8237942726	afifakhann0@gmail.com		
16	Preet Braganza	St. Francisi de Sales College, Seminary hills, Nagpur.	X	Information Technology- Boon or Bane.	+917888104023	preetbraganza22@gmail.com		
17	Sankalp Suryawanshi	Saint Francis de sales college	NR	Artificial intelligence boon or bane	+917758088097	sankalpsuryawanshi0021@gmail.com		
18	Pranjali Sunil Meshram	Shri MathuradasMohota College Of Science	X	Information Technology: Boon or Bane to society	7499410538	meshrampranjali069@gmail.com		

Vangani

CO ORDINATOR
 INTERNAL QUALITY ASSURANCE CELL
 DHARAMPETH, M. P. DEO MEMORIAL &
 SCIENCE COLLEGE, NAGPUR

 Principal
 Dharampeth M. P. Deo Memorial
 Science College, Nagpur.

19	Vaishnavi Rajendra Thakre	Shri mathuradasmohita science College Nagpur	Mathematics in everyday life	9529913491	vaishnavi27thakare@gmail.com	<i>Vaishnavi</i> 3	Paid
20	MrunalPremidasS ayare	S.K. Porwal College, Kampthee	Information Tecinology - Boon or Bane to society	8625936261	sayaremrunal931@gmail.com	<i>Sayare</i> 5	Paid
21	Ayesha Siddiqua	S.K.Porwal College Kamptee	Artificial Intelligence -Boon or Bane	9657294814	ayeshasiddiqua121202@gmail.com	<i>Ayesha</i> 4	Paid
22	Saloni Dhruv Shahu	Shri MathuradasMohota College of Science, Sakkardhara, Nagpur.	Gene editing and it's uses.	8446434431	salonishahu191@gmail.com	<i>Shahu</i> 11	Paid
23	Sejalpurushottam budhabaware	DHARAMPETH MP DEO SCIENCE MEMORIES COLLAGE NAGPUR	Mathematics on everyday life	9766045606	sejalbudhabaware425@gmail.com	<i>Sejal</i> 19	Paid
24	akanshasawzkar	Ramajipundav		+919168429827	sawarkarakansha109@gmail.com	<i>Akansha</i> 15	Paid
26	Sneha premrajbandhane	Nabiramahavidyalayakato		8605136004	Snehabandhane85@gmail.com		

Vengal

Amr
CO ORDINATOR
INTERNAL QUALITY ASSURANCE CELL
DHARAMPETH, M. P. DEO MEMORIAL &
SCIENCE COLLEGE, NAGPUR

Principa
Principal
Dharampeth M. P. Deo Memorial
Science College, Nagpur.

27	Aakash Suresh Harinkhede *	Ramaji Pandav College			8767723336	ashuharinkhede333@gmail.com		
28	Purva Laxman Pathrabe	L.A.D. College			8446234917	purvathrabe@gmail.com	<u>Purva</u> (7)	Paid
29	Krishna Rathod	L.A.D. College			9699623141	hsuretnatsni@gmail.com	<u>Krishna</u> (8)	Paid
30	Tanushri Mishra	L.A.D. College			8669791089	tanu10anna@gmail.com	<u>Tanushri</u> (9)	Paid
31	Nidhi Iyer	L.A.D. College			9420256450	Nidhiyer03@gmail.com	<u>Nidhi</u> (10)	Paid
32	Akshay Bhatkulkare	Shivaji Science college			9359334226	asb6059@gmail.com	<u>Akshay</u> (17)	Paid
33								

Wengani

Wengani
CO ORDINATOR
INTERNAL QUALITY ASSURANCE CELL
DHARAMPETH, M. P. DEO MEMORIAL &
SCIENCE COLLEGE, NAGPUR

Wengani
Principal
Dharampeth M. P. Deo Memorial
Science College, Nagpur



**DHARAMPETH M. P. DEO MEMORIAL SCIENCE COLLEGE, NAGPUR
INTERNAL QUALITY ASSURANCE CELL (IQAC)**

Activity Report

Date:30/04/2023

Name of Organizing Department or Committee:Cultural Event committee 22-23

Name of the activity:Annual Cultural and Sports Event

Suggested CRITERION point if any: Criteria V

Date of Activity: 2nd February to 4th February 2023

Place of Activity: Online

Name of Guest Speaker/s or Judge/s or Chief Guest/s if any:

Title of the Activity: 'Karwa

Number of Participants:Approx. 300

Name of the Teacher In-charge / Convener:Dr.ShraddhaDeshpande

Names of other Committee Members / Staff:All Staff of the college

OUTCOME of the Activity with respect to mission vision of the institute and or academics:

Students organised and participated in competitions such as Rangoli, Mehndi , Singing and Dancing.For students, it is a great way to understand the rich heritage of India and learn about the importance of Indian culture through these extracurricular activities. This is a platform for students to display their talents in various art forms.

Activity with newspaper coverage if any:Nil

Activity data save in PC of:English Department



Prof. Pitambar Humane
IQAC Coordinator
CO ORDINATOR
INTERNAL QUALITY ASSURANCE CELL
DHARAMPETH, M. P. DEO MEMORIAL &
SCIENCE COLLEGE, NAGPUR

Dr. Mrs. Shraddha Deshpande
Teacher In-charge

Dr. Akhilesh Peshwe
Principal
Dharampeth M.P. Deo Memorial
Science College, Nagpur.

ANNUAL CULTURAL EVENT

- **AUDITIONS FOR SINGING COMPETITION.**

1. Mrs. KhrushaliKodape
2. Mrs. Ashwini Shiledar

7/1/23 11:00AM-4:00PM AND 23/1/23 11:00AM-4:00PM

- **AUDITIONS FOR DANCING COMPETITION.**

1. Mrs. Sujata Ali
2. Mrs. Mrunalini Saxena
3. Mrs. Swati Apte
4. Mrs. Ashwini Wanere

7/1/23 11:00AM-4:00PM AND 23/1/23 11:00AM-4:00PM

COMMITTES

- **RANGOLI**

1. Mrs. PayaswiniDhoke
2. Mrs. Archana Gadekar

2/2/2023
10:00AM-11:00AM

- **MEHANDI**

1. Mrs. Sunita Jawade2/2/2023
2. Mrs. Madhavi Kundley11:00AM-12:00PM

- **FETE**

1. Dr. Shraddha Pande
2. Mrs. Archana Patthe1:00PM-3:00PM
3. Mr. HomrajKolhe
4. Mr. Mahesh Pendare

2/2/2023

- **KITE FLYING**

1. Mrs. Sunil Rathod 2/2/2023
2. Dr. Arvind Kale 3:30PM-4:30PM

ANNUAL CULTURAL EVENT

SINGING COMPETITION JUDGES

4/2/23

1. Dr. Arvind Kale **11:00AM-1:00PM**
2. Dr. Manali Kanhe

DANCE COMPETITION JUDGES

4/2/23

1. Mrs. Sujata Ali **1:30PM-4:00PM**
2. Mrs. Shobha Zalke

RANGOLI COMPETITION

2/2/23

1. Dr. Mrs. V.V. Rangari **10:00 AM TO 11:00 AM**
2. Mrs. Archana Pathe

MEHANDI COMPETITION

2/2/23

1. Dr. Mrs. Vaishali Meshram **11:00 AM TO 12:00 PM**
2. Mrs. Bhagyashree Gurjar

FETE COMPETITION

2/2/23

1. Dr. P.T. Humne **1:00P PM TO 3:00 PM**
2. Dr. N.P. Gaikwad
3. Dr. Mrs. K.M. Paturkar
4. Dr. R.R. Pashine



Prof. Pitambar Humane
IQAC Coordinator

CO ORDINATOR
INTERNAL QUALITY ASSURANCE CELL
DHARAMPETH, M. P. DEO MEMORIAL &
SCIENCE COLLEGE, NAGPUR



Dr. Mrs. Shraddha Deshpande
Teacher In-charge



Dr. Akhilesh Peshwe
Principal
Principal
Dharampeth M.P. Deo Memorial
Science College, Nagpur.



Dharampeth M. P. Deo Memorial Science College Nagpur

Annual Cultural Event: Karwa 2022-2023

Convener: Dr. Mrs. Shraddha Deshpande

Vice Principal: Dr. Mrs. Vinaya Kashikar

Supervisor: Dr. Mrs. Shobha Zhalke

Sr. No	Committee	Committee Members	Non-teaching staff
1.	Stage Decoration and Rangoli	Dr. V.R.Kathoke Dr. Vaishali Meshram Mrs. Dipti Iyer, Dr. Apte Mrs. Jawade, Mrs. Priti Wankhede	Mr. Amol Tambe Mr. Santosh Maske Mr. Ravindra Mr. Garkate Mrs. Labde
2.	Rangoli	Mrs. Priyanka Ganorkar, Mrs. Payaswini Dhoke Mrs. Shiledar	Mr. Ambade
3.	<i>Mementoes Shawl and Shripthal (Decorated) Flowers & Bouquets Samai</i>	Dr. Mrs. Shraddha Pande, Dr. Paturkar Mrs. B. Gurjar	Mrs. Rekha Katankar Mrs Kala Banafar
4.	Saraswati Vandana & Pasaydaan	Mrs. Kodape, Mrs. Kane, Dr. Kale Mr. Humbarde (Tabla), Mrs. Shiledar	
5.	Discipline	Dr. Pashine Dr. Kashikar Dr. Zalke	Mr. Dhote Mr. Mandawar Mr. Kamlesh Bhuchunde
6.	Singing and Dancing	Mrs. Snehal narale Mrs. Ruma Kapre Mrs. Dani Mrs. Wannre Mrs. Gadewar Mrs Kundle	

7.	Discipline	<p>Shri. Atul Moghe Dr. Kalode Dr.A.S. Kale Dr. Gaikwad Mr. Sunil Ratho Mr Dilip Hadge</p> <p>Dr. P Ambekar Dr. Humne Mr.Gulhane Mr. Shashi Joshi Mr. Rathod Mr. Walde Mr. Roshan Thakare Mr Deshkar and Mr Ajinkya Nafde Dr.Pashine</p>	<p>Mr.Prashant Mr. Edlabadkar Mr. Mandawar Mr. Pawanikar Mr. Dilip Chaudhary</p>
8.	Fete	<p>Mrs. Manju Deshpande Mrs. Sujata Ali, Mrs. Acharya. Mrs. Saxena</p>	<p>Mrs. Rekha Katankar Mrs Kala Banafar</p>
9.	Sanitation & Hygiene	<p>Shri Pradip Ashtikar to Supervise Shri. Roshan Shri. Keshav + two ladies</p>	

Prof. Pitambar Humane
IQAC Coordinator
CO ORDINATOR
INTERNAL QUALITY ASSURANCE CELL
DHARAMPETH, M. P. DEO MEMORIAL &
SCIENCE COLLEGE, NAGPUR

Dr. Mrs. Shraddha Deshpande
Teacher In-charge

Dr. Akhilesh Peshwe
Principal
Principal
Dharampeth M.P. Deo Memorial
Science College, Nagpur.

04/02/2023:

DANCE

Theme - College Days.
Folk Dance
Classical Dance in Bollywood.



Dharampeth Education Society's

Dharampeth M.P. Deo Memorial Science College,
Nagpur



(NAAC ACCREDITED: GRADE A WITH CGPA 3.01)

CARVAAN 2022-23

10

10

30

NAME OF COMPETITION

Theme - Co-ordination Presentation

Sr.No.	NAME OF STUDENT	A	B	C	TOTAL MARKS
1	Renuka's Group - Ganesh Vandana.	(Not in Competition)			
2	① Yashvi's Khushi Std XI. group.	04	05	04	$04+05+04 = 13 + 12 = 25$
3	② Gondhad Group II Year	05	06	06	$05+06+06 = 17 + 17 = 34$
4	③ Maheshwari's Mahulga Final Year Group	06	07	08	$06+07+08 = 21 + 20 = 41$
5	④ Panchari Panchabhare Solo.	06	07	07	$06+07+07 = 20 + 20 = 40$
6	⑤ Mural Chaudhari II Year Solo.	05	06	07	$05+06+07 = 18 + 15 = 33$
7	⑥ Prachi Manumare III Year Classical.	08	08	07	$08+08+07 = 22 + 23 = 45$
8	⑦ Chennai Express Group.	07	07	06	$07+07+06 = 20 + 19 = 39$
9	⑧ Piyushi Shikhal III Year College days	07	08	08	$07+08+08 = 23 + 16 = 39$
10	⑨ Deepa's Junior College	08	06	06	$08+06+06 = 20 + 19 = 39$
11	⑩ Mohit's Group I Year.	07	07	07	$07+07+07 = 21 + 13 = 34$
12	⑪ Ahlesha Tambode.	08	08	08	$08+08+08 = 24 + 25 = 49$

NAME OF JUDGE 1

Ms. Sujata Ali.

NAME OF JUDGE 2

S. Ali.

4/2/2023

Solo Winners 1st - Ahlesha Tambode

2nd - Rinku Maske

3rd - Prachi Manumare.

Sudeshpande

Principal
Dharampeth M.P. Deo Memorial
Science College, Nagpur.

7/2023



Dharampeth Education Society's

Dharampeth M.P. Deo Memorial Science College, Nagpur



(NAAC ACCREDITED: GRADE A WITH CGPA 3.01)

CARVAAN 2022-23

NAME OF COMPETITION

10
Theme

10
Co-ord.

10
Pre.

Sr.No.	NAME OF STUDENT		B	C	TOTAL MARKS
1	(2) Kanyasri Group - Classical	06	06	07	06+06+07 = 19 + 18 = 37
2	(13) Shubhanghi - Lawns	07	06	07	06+07+07 = 20 + 18 = 38
3	(14) Pathan Group - II Year, College days	08	08	08	08+08+08 = 24 + 21 = 45
4	(15) Sucharita Marlik	08	07	08	08+07+08 = 23 + 20 = 43
5	(16) Neha's Group - I Year	07	08	07	07+08+07 = 22 + 16 = 38
6	(12) Shreyash Nalkwar Group - III Yr.	08	08	07	08+08+07 = 23 + 21 = 44
7	(18) Aishwarya Tashi - Loto	09	08	08	09+08+08 = 25 + 19 = 44
8	(15) Sarcastic Seven - I Year	08	07	07	08+07+07 = 22 + 26 = 48
9	(26) Divyanshi's Group	07	07	07	07+07+07 = 21 + 27 = 48
10	(21) Diborhal Group - Jr. College	07	08	07	07+08+07 = 22 + 19 = 41
11	(23) Rinku Maske	07	07	08	07+07+08 = 22 + 26 = 48
12	(28) Beat Mania Group	09	09	09	09+09+09 = 27 + 28 = 55

NAME OF JUDGE 1
NAME OF JUDGE 2

Mrs. Sujata Ali

S. Ali

gaveshpande

21/2/2023

Group Dance Winners

- 1st - Beat Mania group.
- 2nd - Sarcastic Seven ; Divya group.
- 3rd - Pathan group.

Principal
Dharampeth M.P. Deo Memorial
Science College, Nagpur.

02/02/2023

Theme :- college days, folk dance
classical dance



Dharampeth Education Society's

Dharampeth M.P. Deo Memorial Science College,
Nagpur



(NAAC ACCREDITED: GRADE A WITH CGPA 3.01)

CARVAAN 2022-23

NAME OF COMPETITION

Sr.No.	NAME OF STUDENT	Theme coordination presentation			TOTAL MARKS
		10 ^B	10 ^C	10	
1	Renuka group → Ganesh Vandana	Not	in	competition	30
2	17 Yashasvi & Khushi → XII Std	05	04	03	12
3	27 Gandhal → II year	06	05	06	17
4	3) Maharashtrachi Marli → III year	07	05	08	20
5	4) Panchami Pandabhai (Solo)	06	08	09	23
6	5) Meenal Choudhari (Solo, classical) I year	05	06	06	17
7	6) Poochi Manasmani (Solo, classical) III year	07	07	09	23
8	7) Chennai express gp	05	07	07	22
9	8) Ayushi Shukla (college days, Solo)	06	05	05	16
10	9) Desi Gula group (college)	07	06	06	19
11	10) Mohit and group	05	04	04	13
12	11) Ashlesha Tambde (Solo)	08	08	09	25

NAME OF JUDGE 1

NAME OF JUDGE 2

Mrs. Shobha Zalke

12/2/2023

Satishpande

Principal
Dharampeth M.P. Deo Memorial
Science College, Nagpur.

04/02/2023



Dharampeth Education Society's

Dharampeth M.P. Deo Memorial Science College, Nagpur



(NAAC ACCREDITED: GRADE A WITH CGPA 3.01)

CARVAAN 2022-23

NAME OF COMPETITION

Sr.No.	NAME OF STUDENT	10	10	10	TOTAL MARKS
		Theme	Co-ord	Pres.	
1	127 Rangrazi group	06	06	06	18
2	13) Shubhangi (Lavani) Solo	07	05	06	18
3	14) Pathan group (College days) 11 th year	06	05	08	21
4	15) Sushmita 11 th year solo	06	06	08	20
5	16) Neha and group (College days)	05	05	06	16
6	17) Sheyashita group 11 th year	07	04	08	21
7	18) Atishranya Joshi (Lavni, solo)	08	06	05	19
8	19) Sarcastic Sena (11 th year) group	08	09	09	26
9	20) Diya and group	08	09	08	27
10	21) Dhama group (12 th college)	06	07	06	19
11	22) Rinku Maske (Lavni)	09	09	08	26
12	23) Beat Mania group	09	10	09	28

NAME OF JUDGE 1

Mrs. Shobha Zalke

NAME OF JUDGE 2

04/02/2023

Sandesh pande

Principal
Dharampeth M.P. Deo Memorial
Science College, Nagpur.

Singing.



Dharampeth Education Society's
**Dharampeth M.P. Deo Memorial Science College,
 Nagpur**
 (NAAC ACCREDITED: GRADE A WITH CGPA 3.01)



CARVAAN 2022-23

NAME OF COMPETITION

10 10 10
 54x Taal song selection 30

Sr.No.	NAME OF STUDENT	A	B	C	TOTAL MARKS	
1	Yadnik Dhage (Shiv stuti)	5	5	5	15	✓ 47
2	Puneshottam Parashar (Jai Shri Gauri, etc. etc.)	7	7	8	22	III (✓ 72)
3	Suraj yadav. (Theme/wordings of golden era)	8	6	8	24	II (✓ 66)
4	Prachin Kotpallivas (Azadi ka Amrit Maho) Kesari	5	5	5	15	✓ 49
5	Sonali Chauhan (pyar ke nagme - yado ke dhage)	4	4	5	13	✓ 42
6	Juhi Jadhav (Aga tum sath ho sss)	5	6	6	17	✓ 55
7	Siddhartha (Koi dil pe kabu kar gaya...)	5	5	5	15	✓ 59
8	Shreyansh Nayakwar (Meri sapno ki rani)	8	8	9	25	I (✓ 69)
9	Sakshi Gisi (Gaho me chalo aao...)	6	6	7	19	✓ 54
10	Saniya Naik (Jutehan Hogai - agela kuch hai)	5	6	6	17	✓ 55
11	Mahi Thaware (Apti nazaro ne samza...)	5	4	6	15	✓ 48
12						

NAME OF JUDGE 1 Dr. A.S. Kale ASKale
 NAME OF JUDGE 2 Mrs. Mrs M.M. Kaulio mlf
Mrs M.P. Shiledar .S

Sureshpande

PRINCIPALS SIGN.

Principal
 Dharampeth M.P. Deo Memorial
 Science College, Nagpur



Dharampeth Education Society's

Dharampeth M.P. Deo Memorial Science College, Nagpur

(NAAC ACCREDITED: GRADE A WITH CGPA 3.01)



CARVAAN 2022-23

NAME OF COMPETITION

Sur Taal Song Selection

Sr.No.	NAME OF STUDENT		B	C	TOTAL MARKS
1	Yadrik Dhage (Shiv Stuti)	5	5	5	15 ✓
2	Purushottam Parashar (Natohasani)	8	8	8	(24) (1) ✓
3	Susai Yadav (Ramlala)	8	8	7	(23) (2) ✓
4	Prachi Kotpaliwar (Yemeri Jami)	4	6	6	16 ✓
5	Sonali Chaudhari (Bepanha pyar)	4	5	7	16 ✓
6	Juhi Jadhav (Ages - tum sath ho)	4	6	7	17 ✓
7	Siddharth (Koi dil pe kabu)	4	6	8	18 ✓
8	Shreyansh Nayakwar (Mere sapno ki)	6	8	9	(23) (2) ✓
9	Sakshi Girdi (Boha mein)	5	7	8	20 ✓
10	Saniya Naik (Jindaha ho jayi)	7	9	9	(22) (3) ✓
11	Mahi Thaware (Apki Najdane)	6	6	6	18
12	Pa				

NAME OF JUDGE 1

Dr. Mrs M.M. Kaurhe

NAME OF JUDGE 2

Dr. A.S. Kaurhe

Mrs A.P. Shiledar

ASKale

AS

PRINCIPALS SIGN.

Suresh Pande

Principal
Dharampeth M.P. Deo Memorial
Science College, Nagpur.



Dharampeth Education Society's

Dharampeth M.P. Deo Memorial Science College, Nagpur

(NAAC ACCREDITED: GRADE A WITH CGPA 3.01)



CARVAAN 2022-23

NAME OF COMPETITION

Sur Taal Song selection

Sr.No.	NAME OF STUDENT		B	C	TOTAL MARKS	
1	Yadwik	05	06	06	17	✓
2	Purushottam Parashar (Jagghimeya)	08	09	08	26	1 ✓
3	Suraj Yadav (Mangal Bhavan)	06	07	06	19	✓
4	Prachit	05	06	07	18	3 ✓
5	Sonali Chaudhary (साँसे के साथी) अंकन	04	04	05	13	✓
6	Jini Jadhav (XI) अंतरिक्ष में	07	06	08	21	2 ✓
7	Siddhesh	05	06	05	16	✓
8	Shreyansh Naikwar (मेरे अंतरिक्ष की)	06	07	08	21	✓
9	Sakshi Giri	04	05	06	15	✓
10	Sonik Nikh अंतरिक्ष में	05	05	06	16	✓
11	Mahi Therasse अंतरिक्ष में	04	05	06	15	
12						

NAME OF JUDGE 1

Mrs. Ashwini Shiledkar

NAME OF JUDGE 2

Dr. A. S. Kale

Dr. Mrs M. M. Kanhe

PRINCIPALS SIGN.

Principal
Dharampeth M.P. Deo Memorial
Science College, Nagpur.

Fete



Dharampeth Education Society's

Dharampeth M.P. Deo Memorial Science College, Nagpur



(NAAC ACCREDITED: GRADE A WITH CGPA 3.01)

CARVAAN 2022-23

NAME OF COMPETITION

Sr.No.	NAME OF STUDENT		B	C	TOTAL MARKS
1	Iskandar Sulayman Ali #5	(1)			
2	Thakre - chitral				
3	Prasanna Jha 951919	(3)			
4	Poojitha Ghoshal B.Sc sem I Co #1011	(2)			
5	Ankit Patel B.Sc-T Memorial				
6	Tikha Dasgupta B.Sc.I Cuspeake				
7	Sambhita Patil				
8					
9					
10					
11					
12					

NAME OF JUDGE 1 Dr. K.M. Patilkar

NAME OF JUDGE 2 A. N. P. Gaidhad
Prof. P. T. Humane

PRINCIPALS SIGN.

Principal
Dharampeth M.P. Deo Memorial
Science College, Nagpur.



Dharampeth Education Society's

Dharampeth M.P. Deo Memorial Science College, Nagpur



(NAAC ACCREDITED: GRADE A WITH CGPA 3.01)

CARVAAN 2022-23

NAME OF COMPETITION

Sr.No.	NAME OF STUDENT	10 Marks			TOTAL MARKS
		Design	Innovative	Finishing	
✓1	Goratri Varma	8	8	8	24
✓2	Pallavi Katre	8	7	7	22
3	Vaidehi Pawan Phote				
✓4	Yamini Waghose	9	9	10	28
✓5	Janvi Bhatiya	6	6	5	17
✓6	Sanchita Patil	10	9	9	28
7	Harshata Warkhede				
✓8	Siddhi Tiwari	8	8	7	23
✓9	Divyani Dhule	9	10	8	27
✓10	Prachi Manusmare	8	8	8	24
✓11	Kavita Mishra	9	8	8	25
✓12	Muskan Sheikh	9	9	9	27

NAME OF JUDGE 1 Dr. Mrs. Vaishali Meshram

NAME OF JUDGE 2

WPS Office sharing

Siddhanta

[Signature]
Principal
Dharampeth M.P. Deo Memorial
Science College, Nagpur.



Dharampeth Education Society's

Dharampeth M.P. Deo Memorial Science College, Nagpur



(INAAC ACCREDITED: GRADE A WITH CGPA 3.01)

CARVAAN 2022-23

NAME OF COMPETITION

10 Mark
design

10
Innov

10
Finishing

Total

Sl.No.	NAME OF STUDENT	A	B	C	TOTAL MARKS 30.
1	Akruti Singh				
✓2	Krutika hojare	7	8	7	22
✓3	Tashu chandane	9	8	9	26
✓4	Devashree Bisen	9	8	8	25
✓5	Nikita Bhave	8	8	8	24
✓6	Janvi Kosarkar	9	8	7	24
7	Manju Prajapati	10	10	10	30
✓8	Shital Hatwar	10	9	10	29
✓9	Megha fulwar	9	8	9	26
✓10	Amruta khobragade	8	7	9	24
✓11	Vaishnavi Mahajan	6	7	7	20
✓12	Chinkshi Sonwane	7	7	6	20

NAME OF JUDGE 1

NAME OF JUDGE 2

[Signature]

[Signature]

[Signature]

WPS Office sharing

[Signature]
Principal
Dharampeth M.P. Deo Memorial
Science College, Nagpur



Dharampeth Education Society's

Dharampeth M.P.Deo Memorial Science College, Nagpur



(NAAC ACCREDITED: GRADE A WITH CGPA 3.01)

CARVAAN 2022-23

NAME OF COMPETITION - Mehandi competition
Design Innovative Finishing

Sr.No.	NAME OF STUDENT	A	B	C	TOTAL MARKS 30
1	Gayatri Varma	5	6	5	16
2	Pallavi Katre	8	7	7	22
3	Vaidehi Thote				
4	Yamini Nagose	8	9	8	25
5	Janvi Bhafita	4	5	6	15
6	Sanchita Patil	10	9	9	29
7	Harshita Warkhede				
8	Siddhi Tiwari	7	6	8	21
9	Divyani Dhule	7	7	8	22
10	Prachi Manusmare	7	7	7	21
11	Kavita Mishra	6	7	9	22
12	Muskan Sheikh	7	8	9	24

NAME OF JUDGE 1

NAME OF JUDGE 2 Mrs. Bhagyashree Guniyar

Sureshpanak

Principal
Dharampeth M.P. Deo Memorial
Science College, Nagpur



Dharampeth Education Society's

Dharampeth M.P. Deo Memorial Science College, Nagpur

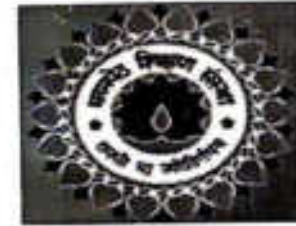

(NAAC ACCREDITED: GRADE A WITH CGPA 3.01)

CARVAAN 2022-23

NAME OF COMPETITION

10
Design Inu
10
Kishu
10

Sr.No.	NAME OF STUDENT		B	C	TOTAL MARKS 30
1	Akshiti Singh				
2	Krutika Haryar	6	7	5	18
3	Devashri Bisen	8	8	8	24
4	Nikita Bhawe	9	7	8	23
5	Janvi Kosarkar	10	10	9	29
6	Manju Prajapati	10	10	9	29
7	Shital Hattwar	10	7	10	17
8	Megha Fulwar	9	7	7	23
9	Amalra Khobragade	8	8	9	25
10	Vaishnavi Mahajan	5	6	5	16
11	Minalshi Sonwane	7	5	5	17
12	Simran Wakdikar	5	7	6	18

NAME OF JUDGE 1

NAME OF JUDGE 2

Suresh pande

[Signature]
Principal
Dharampeth M.P. Deo Memorial
Science College, Nagpur.



Dharampeth Education Society's

Dharampeth M.P. Deo Memorial Science College, Nagpur

(NAAC ACCREDITED: GRADE A WITH CGPA 3.01)

CARVAAN 2022-23



NAME OF COMPETITION

COSTUME CONFIDENCE WEEK

Sl.No.	NAME OF STUDENT	Partner	B	C	TOTAL MARKS
1	Harsh Kodape (Solo)	Muslim	X	X	
2	Nawit Khurdkekar & Neha Vishwakarma (couple)	Madras	X X	X	
3	Vidya Lohi & Sejal (couple)	Maharashtra	X X X	X X	
4	Ishika Nemade (Solo)	Madras	X X	X X X	
5	Jyoti & Siddhartha (couple)	Madras	X X	X X	
6	Arin & Gudi Singh (couple)	Kashmiri	X X	X X	
7	Sonia & Anshul Mishra (couple)	Maharashtra	X X	X	
8	Pooja (Solo)	Gujrati	X	X	
9	Renuka & Prashant (couple)	Bangali	X X	X X	
10	Sakshi Manikar (Solo)	Maharashtra	X X	X	
11	Suhani & Ayush (couple)	Bangali	X X	X	
12	Bhumiika, Samiksha & Shreyansh (couple)	Mahara	X X	X	

NAME OF JUDGE 1

NAME OF JUDGE 2

Dr. Snehal Wakale
Dr. Shraddha Deshpande

1st Prize

Sakshi
Manikar

2nd Prize

Ishika Nemade

Bhumiika, Samiksha
Shreyansh

Vidya Lohi &

SADCHAND

Principal
Dharampeth M.P. Deo Memorial
Science College, Nagpur.



Dharampeth Education Society's

Dharampeth M.P. Deo Memorial Science College, Nagpur

(NAAC ACCREDITED: GRADE A WITH CGPA 3.01)

CARVAAN 2022-23



NAME OF COMPETITION

Sr.No.	NAME OF STUDENT (Solo)		B	C	TOTAL MARKS
1	Minat Chaudhari Bhama Chaudhari	x	x	x	
2	Laxmi Adesh Rinam	Tamil x	xx	xx	
3	Megha & Abhinav (couple)	Bengali x	xx	xx	
4	Rinam (Solo)	x	x	x	
5	Megha (Solo)	South India	xx	x	
6	Tejas & Tisha (couple)	x	x	x	
7					
8					
9					
10					
11					
12					

NAME OF JUDGE 1

NAME OF JUDGE 2

Satishpande

[Signature]
Principal
Dharampeth M.P. Deo Memorial
Science College, Nagpur.



DHARAMPETH M. P. DEO MEMORIAL SCIENCE COLLEGE, NAGPUR

INTERNAL QUALITY ASSURANCE CELL (IQAC)

Activity Report

Date: 02-02-2023

Name of Organizing Department or Committee: Department of Statistics.

Name of the activity: Describe discrete uniform distribution and finding mean and variance.
Suggested CRITERION point if any:

Date of Activity: 02 feb 2023

Place of Activity: Statistics lab

Name of Guest Speaker/s or Judge/s or Chief Guest/s if any:

Title of the Activity: Describe discrete uniform distribution and finding mean and variance
Number of Participants: 22

Name of the Teacher: Durga hingwe

Names of other Committee Members / Staff: N.A.

OUTCOME of the Activity with respect to mission vision of the institute and or academics: The uniform distribution is a symmetric probability distribution where all outcomes have an equal likelihood of occurring.

Activity with newspaper coverage if any: No

Activity data save in PC of: Department of Statistics

Prof. Pitambar Humane
IQAC Coordinator

CO ORDINATOR
INTERNAL QUALITY ASSURANCE CELL
DHARAMPETH, M. P. DEO MEMORIAL &
SCIENCE COLLEGE, NAGPUR

Name & Signature of Teacher In-charge

Dr. Akhilesh Peshwe
Principal
Dharampeth M.P. Deo Memorial
Science College, Nagpur.



DHARAMPETH M. P. DEO MEMORIAL SCIENCE COLLEGE NAGPUR

Department of Statistics

Class: B.Sc. Sem.- II

NEP ACTIVITY

Paper-I

Unit-III

Name of the Teacher: Durga C. Hingule

Date: 02-02-23

Title of Activity: Describe discrete uniform distribution and finding mean and variance

Sr. No.	Name of Student	Batch	Mobile No.	Email ID	Signature
1.	Veena Berikar	SCOM	9322016921	veenaberikar14@gmail.com	<u>Veena</u>
2	Mahul Khadkekar	SCOM	8055328951	mahulkhadkekar@gmail.com	<u>Mahul</u>
3	Sonia Niwal	SCOM	7058425021	niwalsonia10@gmail.com	<u>Sonia</u>
4]	Rutika Yadav	SCOM(F2)	8446085943	yadavarutika434@gmail.com	<u>Rutika</u>
5)	Megha S. Balku	PSM	9421728880	meghabalku@gmail.com	<u>Megha</u>
6)	Pranali V. Gupta	SCOM	7020069377	23991531@gmail.com	<u>Gupta</u>
7)	Divyani V. Zagade	SCOM	9022866318	divyani.v.zagade@gmail.com	<u>Zagade</u>
8	Pseudnya Tipude	SCOM	8010362282	pseudnyatipude9145@gmail.com	<u>Tipude</u>
9)	Janhvi Kinnarapu	SCOM	7058235243	janhvikinnarapu@gmail.com	<u>Kinnarapu</u>
10)	Varsha Turkar	F2	8373650950	varshaturkar488@gmail.com	<u>Turkar</u>
11)	Jagruuti Fulkarwar	SCOM	8767911307	jagruitifulkarwar@gmail.com	<u>Jagruuti</u>
12]	Janvi Khode	SCOM	7385066634	JanviKhode892@gmail.com	<u>Khode</u>
13	Utkarshya Inyale	SCOM	7499159178	utkarshyangale9@gmail.com	<u>Inyale</u>
14)	Nisha Kosankar	SCOM	9890996645	nishakosankar333@gmail.com	<u>Nisha</u>
15)	Janvi Jhanvi Kuber	SCOM	8446510533	jhanvikuber@gmail.com	<u>Kuber</u>
16)	Sakshi Mishra	SCOM	9529889315	smishra94683@gmail.com	<u>Mishra</u>
17)	Gshita Deshpande	SCOM	9130091540	Gshita.deshpande21@gmail.com	<u>Gshita</u>
18)	Janhvi Joge	F2	7385060871	JanhviJoge08@gmail.com	<u>Janhvi</u>
19)	Devashi Kakde	F2 SCOM	9021344265	kakdedevashi@gmail.com	<u>Kakde</u>
20)	Vidya Lohar	F2	7020963219	vidyalohar@gmail.com	<u>Vidya</u>
21)	Pranali Sehankar	F2	8767581278	pdenha@gmail.com	<u>Pranali</u>
22)	Nayan N. Walthare	F1	784187747	NayanWalthare@gmail.com	<u>Walthare</u>

D. Hingule
Signature of Teacher

D. Hingule
Teacher Incharge



Activity Report

Date: 28/02/2023

Name of Organizing Department or Committee: IQAC Initiative

Name of the activity: Golden Jubilee Science Lecture Series

Suggested CRITERION point if any: VI

Date of Activity: 03/02/2023

Place of Activity: College Campus

Name of Guest Speaker/s or Judge/s or Chief Guest/s if any:

Key Note Speaker: Sr. Prof. Shishir Deshpande, Institute for Plasma Research, Ahmedabad.

Other Dignitaries: President, Dharampeth Education Society, Nagpur, Adv. Ulhas

Aurangabadkar, Vice President, Shri. Ratnakar Kekatpure, Secretary, Shri. Mangesh Phatak, Principal of the college, Dr. Akhilesh Peshwe

Title of the Activity: ROLE OF FUSION ENERGY IN ATMANIRBHAR BHARAT: ITER PROJECT & BEYOND

Number of Participants: Students, research scholars, members of the management, retired staff and alumni in large number

Name of the Teacher In-charge / Convener: Prof. Pitambar Humane, IQAC Coordinator, Mrs. Vinaya Kashikar, Vice Principal (Jr. College), Mrs. Shobha Zalke, Supervisor (Jr. College)

Names of other Committee Members / Staff: All Staff Members

OUTCOME of the Activity with respect to mission vision of the institute and or academics:

The Chief Guest highlighted the contributions being done by India in the research & development of the Fusion Nuclear Reactor that is being constructed in France, in which seven countries are playing a major role. He also explained the extremely complex working of the Nuclear Reactor in very easy and simple way. Out of box thinking and beyond, competing with foreign countries and trying to be ahead in use of latest technology, accepting new challenges without fear of failure, perseverance were the key points that he emphasised in his extremely informative and enlightening lecture. He also showed videos of ITER Project & Beyond that kept the students and audience spellbound.

The Golden Jubilee Souvenir of Dharampeth M. P. Deo Science College, Nagpur, was also released at the hands of the Chief Guest, Sr. Prof. Shishir Deshpande, President, Adv. Ulhas Aurangabadkar, Vice President, Shri. Ratnakar Kekatpure, Secretary, Shri. Mangesh Phatak, Principal, Dr. Akhilesh Peshwe, IQAC Coordinator & HOD Botany, Dr. Pitamber Humane, Souvenir Committee members, Mrs. Sujata Ali, Mrs. Ruma Kapre, Mrs. Yogita Acharya and Ms. Vishakha Kaskhedikar.

Activity with newspaper coverage if any: The Hitavada, Tarun Bharat

Activity data save in PC of: Mrs. Ruma Kapre



You Tube Link: <https://www.youtube.com/watch?v=KZGal3oSedo&t=3533s>



A handwritten signature in blue ink, appearing to read 'Pitambar Humane'.

Prof. Pitambar Humane
IQAC Coordinator

CO ORDINATOR
INTERNAL QUALITY ASSURANCE CELL
DHARAMPETH, M. P. DEO MEMORIAL &
SCIENCE COLLEGE, NAGPUR

A handwritten signature in blue ink, appearing to read 'Akhilesh Peshwe'.

Dr. Akhilesh Peshwe
Principal

PRINCIPAL
Dharampeth M. P. Deo Memorial
Science College, Nagpur-440033



DHARAMPETH M. P. DEO MEMORIAL SCIENCE COLLEGE,
North Ambazari Road, Near Ambazari Lake, Nagpur- 440033

DATA VALIDATION & VERIFICATION (DVV)

Name of the Programme : Golden Jubilee Science Lecture Series
Date of the Programme : 03/02/2023
Name of Chief Guest if any : Dr. Prof. Shishir Deshpande, Institute for Plasma Research
Name of Guest Speaker if any : Adv. Vilhas Aurangabadkar, President, DES

Sr. No.	Name of the Participant	Mobile Number	E-mail Id	Year	Signature
1.	Priyanshu V. Bondade	7798484360	11th		P.V. Bondade
	SANVI S. KUPALE	9579754976	11th		Sanku
3.	Amit O. Gupta	9607759577	11th		Amit
4.	Alok Tiwari	9284179052	11th		A Tiwari
5.	Sameer Lilhaze	8830035043	11th		Si
6.	Tejas Yekude	9561978974	11th		Tejas
7.	Gug Meshram	9921143282	11th		Gug
8.	Dhanshree Newalkar	9356516280	2nd year		D. N.
9.	Shrawani Wankhede	7058368837	2nd year		Shrawani
10.	Anjali Mishra	9325604513	2nd year		Anjali

Signature of

Programme in-charge

CO ORDINATOR
INTERNAL QUALITY ASSURANCE CELL
DHARAMPETH, M. P. DEO MEMORIAL &
SCIENCE COLLEGE, NAGPUR

Principal
Dharampeth M. P. Deo Memorial
Science College, Nagpur



DHARAMPETH M. P. DEO MEMORIAL SCIENCE COLLEGE,
North Ambazari Road, Near Ambazari Lake, Nagpur- 440033

DATA VALIDATION & VERIFICATION (DVV)

Samiksha -V- Dongre	9096082938	12 th	
Gayatri . D. Barou	9156136895	12 th	
Arya . R. Rangani	9890889506	12 th	
Shreya . D. Singh	9730711203	12 th	
Shani . O. Jamre	7385354791	12 th	
Shruti . W. Bankar	7709536438	12 th	
Ketki M. Bannugare	7385778307	12 th	
Hrush . P. Shahre	7397899350	12 th	
Abhishek . R. Patel	7709241268	12 th	
Kunal . O. Khandalkar .	9890307012	12 th	
Aakash . T. Maskekar	7499971660	12 th	
Dhruv . P. Paraskar	7498436877	12 th	
Mohit . S. Sonwane	8530781513	12 th	
Harshita Bhatiya	9573129537	12 th	
Mafte .			
Ruchmapratap . N. Singh	8055558503	12 th	

Signature of:

Programme in-charge

IQAC Coordinator
CO-ORDINATOR
INTERNAL QUALITY ASSURANCE CELL
DHARAMPETH, M. P. DEO MEMORIAL &
SCIENCE COLLEGE, NAGPUR

Principal
Principal
Dharampeth M. P. Deo Memorial
Science College, Nagpur



DHARAMPETH M. P. DEO MEMORIAL SCIENCE COLLEGE,
North Ambazari Road, Near Ambazari Lake, Nagpur- 440033

DATA VALIDATION & VERIFICATION (DVV)

Rohit A Parate	9373097285	2nd year	Parate
Niket. Thakre	7378899087	2nd year	<u>Niket</u>
Ashmit Juvare	8080238161	2nd year	Juvare
Rukhil Patil	868335507	2nd year	Patil
Sumanthi Dhanu	7420880382	2nd year	Dhanu
Rishabh Rupesh Shokre	8805887370	2nd year	Shokre
Poojanika Das	9524285039	11th	Das
Arshal Marskolhe	9699589841	11th	A. MARSKOLHE
Bhaggeshree .C./Lumbh	7850681806	12th	Bhaggeshree
Diksha Dambade	7057909621	12th	Dambade
Divya D. Gawande	7385589316	12th	Gawande
Kanchan R. Kosate	8767226517	12th	Kosate
Nehas Anantkumar	7706829700	12th	Nehas
Sunil Kant Tiwari	8957056305	12th	Sunil Kant
Sangharsh Gargbiye	7798303310	12th	Sangharsh
Rishikesh Katakser	8459930301	12th	Rishikesh

Signature of:

Programme In-charge:

IQAC Coordinator
COORDINATOR
INTERNAL QUALITY ASSURANCE CELL
DHARAMPETH, M. P. DEO MEMORIAL &
SCIENCE COLLEGE, NAGPUR

Principal
Dharampeth M. P. Deo Memorial
Science College, Nagpur.



DHARAMPETH M. P. DEO MEMORIAL SCIENCE COLLEGE,
North Ambazari Road, Near Ambazari Lake, Nagpur- 440033

DATA VALIDATION & VERIFICATION (DVV)

Anushka - A. Kawale	7249808293	12 th	Anushka
Mamta M. Patel	9665070902	12 th	Mamta
Ankita B. Pandey	7249588335	12 th	Pandey
Simran Wakodkar	7498102415	12 th	Simran
Gehana Mishra	8767074985	12 th	Gehana
Gunjan Shiwankar	7249886960	12 th	Gunjan
Priyanshi Zhingre	7249886960	12 th	Priyanshi
Soham Uprade	9890230462	3 rd year	Suprade
Sushila Puoti	7507439390	3 rd year	Puoti
Priyanshu Yadav	9970192409	1 st year	Puoti
Pushpak Akshel	7822976866	11 th	Akshel
Anisat Mokaddam	7058988117	MSc I st year	Anisat
Burgesh Gadav	7719891106	11 th	Burgesh
Harsh pal	8484897199	11 th	Harsh pal
Suman Singh	7517419242	11 th	Suman
Bragya Gawhade	7020032840	11 th	Bragya

Signature of:

Programme In-charge:

IOAC Coordinator
COORDINATOR
INTERNAL QUALITY ASSURANCE CELL
DHARAMPETH M. P. DEO MEMORIAL &
SCIENCE COLLEGE, NAGPUR

Principal
Principal
Dharampeth M. P. Deo Memorial
Science College, Nagpur.



DHARAMPETH M. P. DEO MEMORIAL SCIENCE COLLEGE,
North Ambazari Road, Near Ambazari Lake, Nagpur- 440033

DATA VALIDATION & VERIFICATION (DVV)

Abhi Deshbhealan	8208302902	abhishekdeshbhealan@gmail.com	Abhi Deshbhealan
Samir Deshbhealan Ghumde	9359236713	Samirghumde2002@gmail.com	Samir Ghumde
Nikhil Deshbhealan Raut	8208302902	NikhilRaut@gmail.com	Nikhil Raut
Nilesh buike	8624091652	nileshbuike@gmail.com	Nilesh Buike
Aniket Kulkade	9359236713	Aniketkulkade62@gmail.com	Aniket Kulkade
Dinesh Partheti	8624091652	Dineshpartheti@gmail.com	Dinesh Partheti
Prachin R. Kotpallikar	7498102097	PrachinKotpallikar@gmail.com	Prachin R. Kotpallikar
Prachin R. Buraikar	8329760853	PrachinBuraikar@gmail.com	Prachin R. Buraikar
Kunal S Digwar	8010274303	kunaldigwar@gmail.com	Kunal S Digwar
Khushi D. Waghade	9136520783	KhushiWaghade@gmail.com	Khushi D. Waghade
VAISHALVI JADHAV	9166916355	VAISHALVIJADHAV@gmail.com	VAISHALVI JADHAV
Renuka Londe	7719951401	renukalonde@gmail.com	Renuka Londe
Divyanshu V. Zagade	9022866318	divyanshuzagade@gmail.com	Divyanshu V. Zagade
Jayant V. Khode	7315066639	JayantKhode192@gmail.com	Jayant V. Khode
Samiksha A. Panchbudhe	9763075890	Samikshapanchbudhe363@gmail.com	Samiksha A. Panchbudhe
Vaibhav A. Malawat	8767838219	Vaibhavmalawat194@gmail.com	Vaibhav A. Malawat

Signature of:

Programme In-charge

COORDINATOR
INTERNAL QUALITY ASSURANCE CELL
DHARAMPETH, M. P. DEO MEMORIAL &
SCIENCE COLLEGE, NAGPUR

Principal
Dharampeth M. P. Deo Memorial
Science College, Nagpur.



DHARAMPETH M. P. DEO MEMORIAL SCIENCE COLLEGE,
North Ambazari Road, Near Ambazari Lake, Nagpur- 440033

DATA VALIDATION & VERIFICATION (DVV)

Vaishu S. Nimse	9579993869	2 nd year.	vai.shunimise2007@gmail.com
Nikita S. Bhave	9860159628	2 nd year	nikitalbhave98@gmail.com
Urmila V. Bhande	9370673867	II nd year (III rd sem)	bhandeurmila2000@gmail.com
Shravya Dhasale	8888264004	II nd year (III rd sem)	shrapalhasale124@gmail.com
Vaibhavi Shende	8080640782	II nd year (III rd sem)	Vaibhavishende97@gmail.com
Chirayu B. Dole	8010135012	II nd year (IV th sem)	chirayudole22@gmail.com
Sagar S. Bawane	9975460979	2 nd year (I st sem)	sagorbawane537@gmail.com
Lakshmi B. Baur	7219486159	12 th	BaurLakshmi@gmail.com
Kishor D. Bhone	8421944692	12 th	whidhone@gmail.com
Anushka R. Dohare	9370196091	11 th	anushkadohare@28
Pravul S. Shambharkar	9604395092	11 th	Pravul.Shambharkar9290
Kajal T. Beasad	7410763158	2 nd yr	Prasad prasadkajal@gmail.com
Shrushti Patekar	7387067403	2 nd yr HSC	Shrushtipatekar@gmail.com
Vaishnavi Pradhan	9763169560	2 nd yr HSC	Pradhanvaishnavi155@gmail.com
Bhagyavathi Pandey	9175613091	2 nd yr	Bhagyavathipandey@gmail.com

Signature of:

Programme in charge:

 IOAC Coordinator
CO-ORDINATOR
 INTERNAL QUALITY ASSURANCE CELL
 DHARAMPETH, M. P. DEO MEMORIAL &
 SCIENCE COLLEGE, NAGPUR

 Principal
Principal
 Dharampeth M.P. Deo Memorial
 Science College, Nagpur



DHARAMPETH M. P. DEO MEMORIAL SCIENCE COLLEGE,
North Ambazari Road, Near Ambazari Lake, Nagpur- 440033

DATA VALIDATION & VERIFICATION (DVV)

Name of the Programme : Golden Jubilee Science Lecture Series
Date of the Programme : 03/02/2023
Name of Chief Guest if any : Sr. Prof. Shishir Deshpande, Institute for Plasma Research
Name of Guest Speaker if any : Adv. Ulhas Aurangabadkar, President, DES

Sr. No.	Name of the Participant	Mobile Number	Year & mail Id	Signature
1	Ashlesha Sangole	9503998469	2nd year	Sangole
2	Janavi Rogbete	7263819113	2nd year	Janavi
3	Aditya Deskar	9024415176	2nd year	Aditya
4	Budhikesh Mankar	9028225874	2nd year	Budhikesh
5	Kartik Chelkar	8329408166	2nd year	Kartik
6	Anvay Berkar	9168538613	1st year	Anvay
7	Saurabh Tiwari	9927703169	11th	Saurabh
8	Krishna. D. Bulkamwar	9022724101	11th	Krishna
9	Ajay. D. Yadav	9329538602	11th	Ajay
10	Rindam C Wankhede	8010866529	3 rd year	Rindam

Signature of:

Programme In-charge

CO COORDINATOR
INTERNAL QUALITY ASSURANCE CELL
DHARAMPETH M.P. DEO MEMORIAL &
SCIENCE COLLEGE, NAGPUR

Principal
Dharampeth M.P. Deo Memorial
Science College, Nagpur.



DHARAMPETH M. P. DEO MEMORIAL SCIENCE COLLEGE,
North Ambazari Road, Near Ambazari Lake, Nagpur- 440033

DATA VALIDATION & VERIFICATION (DVV)

11)	Madhura Bhandare	8767484914	madhuraobhandare@gmail.com	M.Bhandare
12)	Ayushi Shukla	9373668043	Ayushishukla@gmail.com	A
13)	Shreyansh Naikwar	+441844119	shreyanshnaikwar@gmail.com	Shreyansh
14)	Manish S. Grade	9370329857	Manishgrade23@gmail.com	M Grade
15)	Samiksha Choudhary	7517090406	choudharysamiksha@gmail.com	S.Choudhary
16)	Suman. A. Singh	7249465307	missumansingh3@gmail.com	Suman
17)	Sauniksha N. Kondekar	91452-53758	saunikshakondekar@gmail.com	S.Kondekar
18)	Bhuminika D. Chedge	8830391103	bhuminikachedge@gmail.com	B.Chedge
19)	Vivete R. Waghmare	8956482591	vivete.waghmare@gmail.com	V. Waghmare
20)	Rachika N. Patle	8669238907	rachikapatle4@gmail.com	R.Patle
21)	Swarandi N. Dharne	7420990382	Swarandidharne@gmail.com	S.Dharne
22)	Komal S. Patle	9881748506	Komalpatle234@gmail.com	K.Patle
23)	Vaishnavi K. Kharkate	9763286915	vaishnavikarkate@gmail.com	V.Kharkate
24)	Payal C. Ghumarkar	9067560928	ghumarkarkpayal@gmail.com	P.C. Ghumarkar
25)	Rani D. Kakate	7498945748	Ranidikakate1003@gmail.com	R.Kakate
26)	Sakshi M Ingle	9067877694	sakshingale@gmail.com	S.Ingle

Signature of:

Programme In-charge

IQAC Coordinator

CO-ORDINATOR
INTERNAL QUALITY ASSURANCE CELL
DHARAMPETH M. P. DEO MEMORIAL &
SCIENCE COLLEGE, NAGPUR

Principal

Dharampeth M.P. Deo Memorial
Science College, Nagpur.



DHARAMPETH M. P. DEO MEMORIAL SCIENCE COLLEGE,
North Ambazari Road, Near Ambazari Lake, Nagpur- 440033

DATA VALIDATION & VERIFICATION (DVV)

27	Simran G. Talmale	7472530338	simrantal@gmail.com	
28)	Shradha B. Raje	7776809083	shradharaje74@gmail.com	
29	Shruti J. Bhivagade	8767898279	ShrutiBhiv@gmail.com	
30	Prachi P. Sontakke	9765362914	Prachisontakke62@gmail.com	
31)	Pratik S. Ramteke	7249605504	Pratikramteke72@gmail.com	
32	Aniket - Gt Chamate	9075165657	aniketchamate5@gmail.com	
33	Akshay - S. Pawhar	8390746842	akshaypawhar96@gmail.com	
34	Akash. K. Nabik	7798125870	akashnabik933@gmail.com	
35	Jyegesh R. Chauhan	8624890264	Chauhandyegesh@gmail.com	
36	Jyoti P. Chaudhari	9309784876	9309784876	
37	Arjun B. Desai	7822926631	arjundesai06@gmail.com	
38	Om. Worankar	8830442397	om.worankar@gmail.com	
39	Jay V. Karkde	7620145767	JayKarkdes@gmail.com	
40	Ankit D. Chaudhari	825675325	Ankitchaudhari@gmail.com	

Signature of:

Programme In-charge

IOAC COORDINATOR
INTERNAL QUALITY ASSURANCE CELL
DHARAMPETH, M. P. DEO MEMORIAL &
SCIENCE COLLEGE, NAGPUR

Principal
Dharampeth M. P. Deo Memorial
Science College, Nagpur.



DHARAMPETH M. P. DEO MEMORIAL SCIENCE COLLEGE,
North Ambazari Road, Near Ambazari Lake, Nagpur- 440033

DATA VALIDATION & VERIFICATION (DVV)

1)	Rushali D. Bhoskar	3579485597	2 nd Year	Rushali
2)	Pawan S. Vishwakarma	7058408869	2 nd Year	Pawan
3)	Ankit R. Mesheam	8788590239	11 th	Ankit
4)	Gaurav Raju Rajurkar	9657951153	11 th	Gaurav
5)	Devashish S. Yessansule	7218916554	11 th	Devashish
6)	Pritam S. Pathak	9075213887	11 th	Pritam
7)	Vidya Lohi	7020963219	1 st year	Vidya
8)	Devashish D. Bisen	7767861231	2 nd year	Devashish
9)	Devashri D. Bisen	7773980643	2 nd year	Devashri
10)	Jay A Patil	7385436956	2 nd year	Jay
11)	Nupur M. Sharma	822042269	2 nd year	Nupur
12)	Adityakumar Shukla	9918984638	2 nd year	Aditya
13)	Praduman A. Singh	7666939960	2 nd year	Praduman
14)	Kavita S. Mishra	9657199261	2 nd year	Kavita
15)	nitin Khushbu	9693429005	2 nd year	Nitin
16)	Divya Hanote	8605422901	2 nd year	Divya

Signature of:

Programme In-charge

CO-ORDINATOR
INTERNAL QUALITY ASSURANCE CELL
DHARAMPETH, M. P. DEO MEMORIAL &
SCIENCE COLLEGE, NAGPUR

Principal
Principal
Dharampeth M.P. Deo Memorial
Science College, Nagpur.



DHARAMPETH M. P. DEO MEMORIAL SCIENCE COLLEGE,
North Ambazari Road, Near Ambazari Lake, Nagpur- 440033

DATA VALIDATION & VERIFICATION (DVV)

1)	Ananya Motghare	7219218955	2nd year	Ananya
2)	Aditi Lube	7820812808	2nd year	Aditi
3)	Shruti Patil	7218079074	2nd year	Shruti
4)	Sanyam Bhardwaj	9172618808	12th	Sanyam
5)	BHLOMI HIRWANI	9850573793	12th	Bhloami
6)	Ruchita Wasekar	8421922584	12th	Ruchita
7)	Rugya S. Tiwari	6394098386	H.Sc 2nd year	Rugya
8)	Anamika S. Shenwai	9096507459	H.Sc 2nd year	Anamika
9)	Ujaswi Wankhede	8767699751	H.Sc 2nd year	Ujaswi
10)	Kimaya Kale	8866073792	H.Sc 2nd year	Kimaya
11)	Tannu Konde	7841984450	H.Sc 2nd year	Tannu
12)	Priya Klawshi	9763617224	H.Sc 2nd year	Priya
13)	Neha N. Pimpale	9657956647	11th	Neha
14)	Dolly B. Gadhane	9284269236	3rd year	Dolly
15)	Prachi K. Vekhaphe	9325836932	3rd year	Prachi
16)	Aakanksha Bhute	9356964127	3rd year	Aakanksha

Signature of:

Programme In-charge

CO ORDINATOR
INTERNAL QUALITY ASSURANCE CELL
DHARAMPETH, M. P. DEO MEMORIAL &
SCIENCE COLLEGE, NAGPUR

Principal
Dharampeth M.P. Deo Memorial
Science College, Nagpur.



DHARAMPETH M. P. DEO MEMORIAL SCIENCE COLLEGE,
North Ambazari Road, Near Ambazari Lake, Nagpur - 440033

DATA VALIDATION & VERIFICATION (DVV)

1)	Monika J. Patel	7499925468	1 st year	
2)	Vaishali Sahaw	9972925463	1 st year	
3)	Shreya G. Bhinte	9637762511	1 st year	
4)	Ashwini R. Chaudhary	9699792732	1 st year	
5)	Khineshwari R. Pushptale	8624976072	1 st year	
6)	Sooraj Yadav	8767435158	3 rd year	
7)	Poojwal Bhade	9834016826	2 nd year	
8)	Sobuj Prasad	7410764148	2 nd yr.	
9)	Muskan Yadav	9579492617	2 nd yr.	
10)	Twinkle Lochande	1111111	2 nd yr	

Signature of:

Programme In-charge

COORDINATOR
INTERNAL QUALITY ASSURANCE CELL
DHARAMPETH, M. P. DEO MEMORIAL &
SCIENCE COLLEGE, NAGPUR

Principal
Dharampeth M.P. Deo Memorial
Science College, Nagpur.



DHARAMPETH M. P. DEO MEMORIAL SCIENCE COLLEGE,
North Ambazari Road, Near Ambazari Lake, Nagpur- 440033

DATA VALIDATION & VERIFICATION (DVV)

Name of the Programme : Golden Jubilee Science Lecture Series
Date of the Programme : 03/02/2023
Name of Chief Guest if any : Dr. Prof. Shishir Deshpande, Institute for Plasma Research
Name of Guest Speaker if any : Adv. Uhas Aurangabadkar, President, DES

Sr. No.	Name of the Participant	Mobile Number	Email Id Year	Signature
1	Jaganti. R. Waghmare	8080265524	11 th	Jaganti
2)	Vaishnavi V Lambert	7058364316	11 th	V Lambert
3)	Jayashree .P. Bobade	7796224175, 9356275511	11 th D	J Bobade
4)	Divya . Sh. Shahu	9503235407	11 th D	Divya
5)	Shikha Yadav	7263881320	BSC Sem IV	S. J. Yadav
6)	Sushma Gurunee	9156238747	Bsc sem IV	Sushma
7)	Katika .M. Deshmukh	9694720960	BSC Sem II	K. Deshmukh
8)	Mahi .S. Shaware	9960629566	BSC - Sem II	Mahi
9)	Umang G. Wanthi	9822428500	BSC Sem II	U. Wanthi
10)	Sourina. ^{Chavhan} Anamole Chande	9769004929	BSC Sem III	Sourina

Signature of

Programme In-charge

ICAC Coordinator
CO ORDINATOR
INTERNAL QUALITY ASSURANCE CELL,
DHARAMPETH, M. P. DEO MEMORIAL &
SCIENCE COLLEGE, NAGPUR

Principal
Dharampeth M.P. Deo Memorial
Science College, Nagpur.



DHARAMPETH M. P. DEO MEMORIAL SCIENCE COLLEGE,
North Ambazari Road, Near Ambazari Lake, Nagpur- 440033

DATA VALIDATION & VERIFICATION (DVV)

11	Shruti P. Masram	8308657972	Bsc Sem II	shruti
12	Mahima S. Khare	9545918678	BSC Sem II	Mahima
13	Mohit Khindekar	8053328357	BSC Sem II	Mohit
14	TANU. H. SINGH	8806355808	BSC Sem II	Tanu
15	Siddhi B. Jiwari	8087143696	BSC Sem II	Siddhi
16	Pratul Gaidwad	7083995899	B. Sc Sem II	Pratul
17	Sagar Sonwane	9256591564	B.Sc Sem VI	Sagar
18	Vaidehi Thete	7558990181	B.Sc Sem II	Vaidehi
19	Saurabh Sharma	9130964601	B.Sc Sem VI	Saurabh
20	Muskan Kulkarni	9156889239	BSC Sem II	Muskan
21	Prathmesh Badiye	9765262738	B.CC Sem IV	Prathmesh
22	Bitika Sondhlye	9175581655	BSC Sem II	Bitika
23	Priya S. Tete	8799813520	11th D	Priya
24	Tashu D. Chhonde	7850530943	11th D	Tashu
25	Neha R. Khawale	8766738340	B.Sc Sem VI	Neha
26	Asha S. Landge	9322231581	B.Sc Sem II	Asha S Landge

Signature of:

Programme In-charge

CO ORDINATOR
INTERNAL QUALITY ASSURANCE CELL
DHARAMPETH M. P. DEO MEMORIAL
SCIENCE COLLEGE, NAGPUR

Principal
Dharampeth M.P. Deo Memorial
Science College, Nagpur.



DHARAMPETH M. P. DEO MEMORIAL SCIENCE COLLEGE,
North Ambazari Road, Near Ambazari Lake, Nagpur- 440033

DATA VALIDATION & VERIFICATION (DVV)

27.	Jyoti J. Sharma	9669796380	Bsc(2 nd year)	J. Sharma
28.	Siddhanta G. Hikkane	9579092931	Bsc (2 nd year)	Siddhanta
29.	Pratiksha Meshram	8459070338	BSC (1 st year)	Pratiksha
30.	Ritika Bhojar	9834587087	BSC (1 st year)	Ritika
31.	Pratibha Bhusari	7821048413	BSC (1 st year)	Pratibha
32.	Shivam Patel	7038889083	B.sc. (1 st year)	Shivam
33.	Shital Patil	9764596337	B.S.c (2 nd year)	Shital
34.	Ankit Patel	9970905638	BSC (1 st year)	Ankit
35.	Saurabha Choudhary	9959883501	BSC (1 st year)	Saurabha
36.	Aditya R. Mishra	9595229551	12 th class	Aditya
37.	Aman R. Patel	9799586734	12 th class	Aman
38.	Humisha Navneet	9508208865	12 th class	Humisha
39.	Monal Sonke	—11—	12 th class	Monal
40.	Premising Rahangdale	8551805592	12 th	Premising
41.	Chandrashekhar —11—	7841953208	BSC 1 st year	Chandrashekhar
42.	Rohit - Pandey	8767788703	BSC 1 st Year	Rohit

Signature of:

Programme In-charge

IQAC Coordinator
CO ORDINATOR
INTERNAL QUALITY ASSURANCE CELL
DHARAMPETH M. P. DEO MEMORIAL &
SCIENCE COLLEGE, NAGPUR

Principal
Dharampeth M.P. Deo Memorial
Science College, Nagpur.



DHARAMPETH M. P. DEO MEMORIAL SCIENCE COLLEGE,
North Ambazari Road, Near Ambazari Lake, Nagpur- 440033

DATA VALIDATION & VERIFICATION (DVV)

43	Manu. P. Pat.	7330450579	B.Sc year	<i>[Signature]</i>
44	Neha Suresaut	9067167848	B.Sc Home.Sci	<i>[Signature]</i>
45	Neha R Vishwakarma	8988534173	B.sc Home.sci	Neha
46	Aniket J Bawankar	9767219301	B. S. C year	<i>[Signature]</i>
47	Shrutika G. Pise	9322316336	BSc 1st year	<i>[Signature]</i>
48	Sumiksha Bhendke	7420881158	BSc 1st year	<i>[Signature]</i>
49	Vaidhi Nagarkar	9325969446	B.Sc 1st year	<i>[Signature]</i>
50	Divyani G Zade	7972403069	BSc 1st year	<i>[Signature]</i>
51	Karishma N. Prasad	9309318667	B.Sc 1st year	Karishma
52	Rani D. Patel	7888241794	B.Sc 3 rd year	<i>[Signature]</i>
53	Kartik Adlakha	8530597159	BSc 3 rd yr	<i>[Signature]</i>
54	Vishal Kumar Singh	9610187223	BSC 3 rd yr	<i>[Signature]</i>
55	Tshwan Suresawanshi	8087317297	BSC 3 rd yr	<i>[Signature]</i>
56	Ranjit Patte	7887934824	BSC 3 rd yr	<i>[Signature]</i>
57	Akash Sirkhad	9175422051	BSC 3 rd yr	Akash
58	Shiyam Maniya	9607873702	BSC 3 rd yr	<i>[Signature]</i>

Signature of:

Programme In-charge

[Signature]
IQAC Coordinator
CO ORDINATOR
INTERNAL QUALITY ASSURANCE CELL
DHARAMPETH M. P. DEO MEMORIAL &
SCIENCE COLLEGE, NAGPUR

[Signature]
Principal
Principal
Dharampeth M.P. Deo Memorial
Science College, Nagpur.



DHARAMPETH M. P. DEO MEMORIAL SCIENCE COLLEGE,
North Ambazari Road, Near Ambazari Lake, Nagpur- 440033

DATA VALIDATION & VERIFICATION (DVV)

59.	Pollavi Bhagat	9022654940	Bsc 3rd yr	P Bhagat
60.	Tanmay Bhute	7697250831	Bsc 3rd yr	Tanmay
61.	Anshuman Sharma	9370992462	Bsc 3rd yr	Anshuman
62.	Chetan Kamthe	9637271601	Bsc 3rd yr	Chetan
63.	Pratham Gupta	8767275149	Bsc 3rd yr	P Gupta
64.	Mukesh Oraon	8379049368	Bsc 3rd yr.	Mukesh
65.	Priyanshu Singh	7775800561	Bsc 3rd yr.	Priyanshu
66.	Yukti Dhuwadhapade	7058269794	12 th	Yukti
67.	chetan Jadhav	7058522146	2 nd year	Chetan
68.	Shradha Bhakre	9356944630	12 th	Shradha
69.	Akshad Singh	917596140	XII th	Akshad
70.	Harnish Humane	7507914785	12 th	Harnish
71.	Hanshal. u. M. Shree	8767992849	12 th	Hanshal
72.	Abha B. Simukaddam	7757971814	12 th	Abha
73.	Unnati. s. Thakur	8830304822	12 th	Unnati
74.	Anjali. Sable	9011509573	12 th	Anjali

Signature of:

Programme In-charge

IGAC Coordinator
INTERNAL QUALITY ASSURANCE UNIT
DHARAMPETH M. P. DEO MEMORIAL SCIENCE COLLEGE

Principal
Dharampeth M. P. Deo Memorial
Science College, Nagpur.



DHARAMPETH M. P. DEO MEMORIAL SCIENCE COLLEGE,
North Ambazari Road, Near Ambazari Lake, Nagpur- 440033

DATA VALIDATION & VERIFICATION (DVV)

Name of the Programme : Golden Jubilee Science Lecture Series
Date of the Programme : 03/02/2023
Name of Chief Guest if any : Sr. Prof. Shishir Deshpande, Institute for Plasma research
Name of Guest Speaker if any : Adv. Ulhas Aurangabadkar, President, DES.

Sr. No.	Name of the Participant	Mobile Number	E-mail Id / Year	Signature
1	Chyareul Sawajkar	9921652613	XI th	
2	Shruti Kaware	9049258171	XI th	
3	Shivam Kushwaha	9373885814	XI th	
4	Harsh Sharma	7507959383	XI th	
5	Lokesh Sahare	8785086116	XI th	
6	Rohit Gupta	7385628717	XI th	
7	Depak Marthe	7517309182	XII th	
8	Divya Choudhari	7262074960	XI th	
9	Divya Narnaware	9309831812	XI th	
10	Ruchita Dhobali	9067934719	XI th	

Signature of:

Programme In-charge:

IQAC Coordinator
CO ORDINATOR
INTERNAL QUALITY ASSURANCE CELL
DHARAMPETH, M. P. DEO MEMORIAL &
SCIENCE COLLEGE, NAGPUR

Principal
Dharampeth M.P. Deo Memorial
Science College, Nagpur



DHARAMPETH M. P. DEO MEMORIAL SCIENCE COLLEGE,
North Ambazari Road, Near Ambazari Lake, Nagpur- 440033

DATA VALIDATION & VERIFICATION (DVV)

11	Nikita S Barapatre	7058625053	2 nd year	Natapatre
12	Ayush A Kadam	9763013263	2 nd year	Ayush
13	Gaurav Landge	7767854087	2 nd year	Gaurav
14	Khushi R. Patil	8767607224	1 st year	Khushi
15	Ankush Khurpadi	7241884620	1 st year	Ankush
16	Akshay Khanchore	7350956800	2 nd year	Akshay
17	Durgesh Rokhale	4730561301	2 nd year	Durgesh
18	Rohan H. Meshram	7499956761	1 st year	Rmeshram
19	Ravindra madhukar Khadke	8007198273	1 st year	Ravindra
20	Arya Dhoke	8080851619	1 st year	Arya
21	Yogita Dengle	0069938027	1 st year	Yogita
22	Komalika .S. chaudhari	9322033866	I st year	Komalika
23	Juhi .S. chaudhari	8669248944	II nd year	Juhi
24	Sakshi Meshram	9145355733	2 nd year	Sakshi
25	Mansi Mate	8468891807	2 nd year	Mansi
26	Apeksha Kotangale	7559455794	I st year	Akotangale

Signature of:

Programme in-charge

Signature of
IQAC Coordinator
CO ORDINATOR
INTERNAL QUALITY ASSURANCE CELL
DHARAMPETH M. P. DEO MEMORIAL &
SCIENCE COLLEGE, NAGPUR

Signature of
Principal
Principal
Dharampeth M. P. Deo Memorial
Science College, Nagpur.



DHARAMPETH M. P. DEO MEMORIAL SCIENCE COLLEGE,
North Ambazari Road, Near Ambazari Lake, Nagpur- 440033

DATA VALIDATION & VERIFICATION (DVV)

27.	Vaishnavi tonge	8421657943	1 st year	<u>Vaishnavi</u>
28	Samyak Hadke	7020171304	1 st year	<u>Samyak</u>
29	Rishika kokate	9637554918	1 st year	<u>Rishika</u>
30	Anjali thakre	7066554821	1 st year	<u>Anjali</u>
31	Manthan Todase	8080870430	1 st year	<u>Manthan</u>
32	Anshul Kirnapure	9284067169	1 st year	<u>Anshul</u>
33	Jeet Parodhi	7070215431	1 st Year	<u>Jeet</u>
34	Prerna Chaudhari	7670384149	1 st Year	<u>Prerna</u>
35	Nisha Kosarkar	9890996645	1 st Year	<u>Nisha</u>
36	Sejal Kolhe	8483045985	1 st year	<u>Sejal</u>
37	Vadlivee gogant	7507907278	1 st year	<u>Vadlivee</u>
38	Sonaya Nitwal	7058425021	1 st year	<u>Sonaya</u>
39	Devashri Kekde	9021342265	1 st year	<u>D. P. Kekde</u>
40	Anjali thakre		1 st year	<u>Anjali</u>
41	Pranali Dehnkar	89675	1 st year	<u>Pranali</u>
42.	Tanvi chavale	8459543857	1 st year	<u>Tanvi</u>

Signature of:

Programme In-charge:

COORDINATOR
INTERNAL QUALITY ASSURANCE CELL
DHARAMPETH, M. P. DEO MEMORIAL &
SCIENCE COLLEGE, NAGPUR

Principal
Dharampeth M.P. Deo Memorial
Science College, Nagpur.



DHARAMPETH M. P. DEO MEMORIAL SCIENCE COLLEGE,
North Ambazari Road, Near Ambazari Lake, Nagpur- 440033

DATA VALIDATION & VERIFICATION (DVV)

43.	Poonam Chauhan	8161765121	3 rd year	
44.	Vaibhav Ingle	830037279	1 st year	
45.	Nikhil Kumar	899304030	1 st year	
46.	Tejas G. Salunke	7030730670	3 rd year	
47.	Laxmi M. Gorde	4758058514	2 nd year	
48.	Anushree Wale	8530778433	3 rd year	
49.	Nandini Kedge	9370301679	5 th year	
50.	Shikha Thakur	9021541048	3 rd yr	
51.	Siddhi Mankar	9579169313	12th	
52.	Tisha Kulkarni	9860468914	3 rd year	
53.	Adesh Hartuar	7517431162	3 rd year	
54.	Kantik Adlaknia	9021541048	3 rd yr	
55.	Aishwarya. Joshi	9021541048	3 rd yr	
56.	Sheuti Pawar	8026149867	8390784121	
57.	Bhargavi Sambare	7709403806	3 rd year	
58.	Angeli P. Pali	7498102109	3 rd year	

Signature of:

Programme in-charge

IQAC Coordinator
CO ORDINATOR
INTERNAL QUALITY ASSURANCE CELL
DHARAMPETH, M. P. DEO MEMORIAL &
SCIENCE COLLEGE, NAGPUR

Principal
Dharampeth M.P. Deo Memorial
Science College, Nagpur.



DHARAMPETH M. P. DEO MEMORIAL SCIENCE COLLEGE,
North Ambazari Road, Near Ambazari Lake, Nagpur- 440033

DATA VALIDATION & VERIFICATION (DVV)

59	PRAGYA JHA	9605852975	3 rd year	Jha
60	AKANKSHA YELURE	8767935524	3 rd year	Akanksha
61	FRIYANSHI SHINGE	7219259020	3 rd year	Shinge
62	Chaitali burbade	9959215917	3 rd year	Chaitali
63	Raksha dhote	7498511875	3 rd year	Raksha
64	pallavi Bhogt	9022654940	3 rd year	Bhogt
65	Nikita Ekhe	7972190515	3 rd year	Ekhe
66	Shivani Bhute	9302900209	3 rd year	Shivani
67	nusran shaikh	8055474633	3 rd year	Nusran
68	sakshi moon	7745827736	3 rd year	Sakshi
69	megha fulwar	8605399606	3 rd year	Megha
70	Vaishnavi chandekar	7249882964	3 rd year	Chandekar
71	Aniket m. Bansod	77083928684	11 th	Bansod
72	Shubhraj gaybhaye	7385085335	11 th	Shubhraj
73	Tanishk Khanzode	8668424122	11 th	Tanishk
74	Utkarsh Nandekar	99511805184	11 th	Utkarsh

Signature of:

Programme In-charge

IQAC Coordinator

CO ORDINATOR

INTERNAL QUALITY ASSURANCE CELL
DHARAMPETH M. P. DEO MEMORIAL SCIENCE COLLEGE

Principal

Dharampeth M. P. Deo Memorial
Science College, Nagpur.



DHARAMPETH M. P. DEO MEMORIAL SCIENCE COLLEGE,
North Ambazari Road, Near Ambazari Lake, Nagpur- 440033

DATA VALIDATION & VERIFICATION (DVV)

75	Jaxmi R. Ambulkar	9834976157	11 th	Ambulkar
76	Khushbu M. Babhase	8459089989	11 th	Rhushbu
77	Babraj M. Wada	8420396682	Bsc III year	Wada
78	Kaustubh R. Ramteke	7218487714	B.Sc 3 rd y ^o .	Ramteke
79	Shubham P. Khobragade	9518788915	-11-	Shubham
80	Vanshika C. Yede	7558249609	-11-	Yede
81	Meenali Sonzate	9850163812	-11-	Meenali
82	Saniya P. Nautk	9370570457	-11-	Nautk
83	Sakshi V. Chamate	7709204933	-11-	Sakshi
84	Nishakha G. Gowhade	7620351270	-11-	Gowhade
85	Sakshi P. Mankar	8180816539	-11-	Mankar
86	Shwanti M. Gaikwad	7385532705	-11-	Gaikwad
87	Roshani M. Bambal	9325853608	-11-	Bambal
88	Sakshi Giri	9529660277	-11-	Sakshi
89	Neha Mundore	8766694297	-11-	Neha

Signature of:

Programme In-charge

Signature of
CO-ORDINATOR
INTERNAL QUALITY ASSURANCE CELL
DHARAMPETH, M. P. DEO MEMORIAL &
COLL.

Signature of
Principal
Dharampeth M. P. Deo Memorial
College
Nagpur



DHARAMPETH M. P. DEO MEMORIAL SCIENCE COLLEGE, NAGPUR

INTERNAL QUALITY ASSURANCE CELL (IQAC)

Activity Report

Date: 4/2/23

Name of Organizing Department or Committee: Zoology

Name of the activity: Training to handle BP apparatus

Suggested CRITERION point if any: Criteria I

Date of Activity: 3/02/2023

Place of Activity: Department of Zoology, Nagpur

Name of Guest Speaker judge/s or Chief Guest/s if any: NA

Title of the Activity: Training to handle BP apparatus

Number of Participants: 26

Name of the Teacher In-charge / Convener: Dr. P.D.Khandelwal

Names of other Committee Members / Staff: Dr. K. M. Paturkar

OUTCOME of the Activity with respect to mission vision of the institute and or academics:

The Objective behind training to handle the BP apparatus and student get knowledge and it is useful to them in day to day life and give knowledge to the participants within academics as well as beyond academics and to make them familiar with apparatus. Students get in depth knowledge about BP apparatus.

Activity with newspaper coverage if any: NIL

Activity data save in PC of: Zoology Department/personal laptop



Dr. Pooja Khandelwal

Name & Signature of Teacher In-charge

Prof. Pitambar Humane

IQAC Coordinator
CO ORDINATOR
INTERNAL QUALITY ASSURANCE CELL
DHARAMPETH, M. P. DEO MEMORIAL &
SCIENCE COLLEGE, NAGPUR

Dr. Akhilesh Peshwe

Principal
Principal
Dharampeth M. P. Deo Memorial
Science College, NAGPUR.



DHARAMPETH M. P. DEO MEMORIAL SCIENCE COLLEGE,
North Ambazari Road, Near Ambazari Lake, Nagpur- 440033

DATA VALIDATION & VERIFICATION (DVV)

Name of the Programme : Training to handle BP apparatus
Date of the Programme : 3/02/23
Name of Chief Guest if any : _____
Name of Guest Speaker if any : _____

Sr. No.	Name of the Participant	Mobile Number	E-mail Id	Signature
1.	Chanchal. K. Waghmare	7796016894	waghmarechanchal@gmail.com	Chanchal
2.	Khushi. K. Rewade	9588445994	Khushirewade@gmail.com	Rewade
3.	Lucky A Vishwakarma	9579660186	lvishwakarma@20@gmail.com	Vishwakarma
4.	Chiranjiv S. Gajbhiye	8329412694	cgajbhiye17@gmail.com	Gajbhiye
5.	Aakansha Maital	8010923662	aakanshamaital@gniiu.com	Aakansha
6.	Dolly Wanjare	9326013213	Krishnawanjari2945@gmail.com	Dolly
7.	Anshul Yadav	9156494085	anshul.yadav01521@gmail.com	Anshul
8.	Sunaina Chichonde	8530970132	sunainachichonde@gmail.com	Sunaina
9.	Ashalesha Khadgi	7820929579	Ashaleshakhadgi@gmail.com	Ashalesha
10.	Ghanashree U. Dhokane	7776300320	dhokaneghanashree@gmail.com	Ghanashree
11.	Monal A Chulhary	9529014604	monalchulhary2001@gmail.com	Chulhary
12.	Vaideshi Thare	7558999191	vaideshithare21@gmail.com	Vaideshi
13.	Umang Wadhwa	9322428500	umangwadhwa@gmail.com	Umang
14.	Kaartika Deshmukh	9699720960	KaartikaD@gmail.com	Kaartika
15.	Ritika Sandhiya	9179581655	ritikaP.Sandhiya@gmail.com	Ritika

Signature of: _____
Programme In-charge

IQAC Coordinator
CO ORDINATOR
INTERNAL QUALITY ASSURANCE CELL
DHARAMPETH, M. P. DEO MEMORIAL &
SCIENCE COLLEGE, NAGPUR

Principal
Principal
Dharampeth M. P. Deo Memorial
Science College, NAGPUR



DHARAMPETH M. P. DEO MEMORIAL SCIENCE COLLEGE,
North Ambazari Road, Near Ambazari Lake, Nagpur-440033

DATA VALIDATION & VERIFICATION (DVV)

Name of the Programme : _____
 Date of the Programme : _____
 Name of Chief Guest if any : _____
 Name of Guest Speaker if any : _____

Sr. No.	Name of the Participant	Mobile Number	E-mail Id	Signature
1.	Priya Sharma	8010764549	priyusharma19012004@gmail.com	
2.	Siddhi Tiwari	8087143696	siddhitiwari0721@gmail.com	
3.	Muskan Kulkarni	89156889237	muskanmuskani@gmail.com	
4.	Peamali Chavhare	9699654562	peamalichavhare09@gmail.com	
5.	Peatiksha Meshram	8459070338	meshrampeatiksha14@gmail.com	
6.	Yashika K. Panaley	9156035297	panaleykns54@gmail.com	
7.	Tanu T. Dhawale	8459543857	tanudhawale7@gmail.com	
8.	Krutika S. Pokale	9021533341	pokalekrutika6@gmail.com	
9.	Shreya Jha	898323602	songhatajha0302@gmail.com	
10.	Riya Singh	9595049831	siya2307@gmail.com	
11.	Dhanashree Neware	9359909913	dhanashreeneware75@gmail.com	
12.				
13.				
14.				
15.				

Signature of:

Programme In-charge

CIQAC Coordinator
INTERNAL QUALITY ASSURANCE CELL
DHARAMPETH, M. P. DEO MEMORIAL &
SCIENCE COLLEGE, NAGPUR

Principal
Principal
Dharampeth M. P. Deo Memorial
Science College, NAGPUR.



DHARAMPETH M. P. DEO MEMORIAL SCIENCE COLLEGE, NAGPUR

INTERNAL QUALITY ASSURANCE CELL (IQAC)

Activity Report

Date: 6th February 2023

Name of Organizing Department or Committee : Electronics Department

Name of the Activity : Poster making of 8051

Suggested CRITERION point if any : Suggested criteria II

Date of Activity : 6th February 2023

Place of Activity : Electronics Lab

Name of Guest Speaker/s or Judge/s or Chief Guest/s if any : Not applicable

Title of the Activity: Poster making of 8051

Based on Unit : 1(Paper II)

Class : Semester VI

Number of Participants : 15

Name of the Teacher In-charge / Convener: Prof. V. V. Rangari

OUTCOME of the Activity with respect to mission vision of the institute and or academics:

Students learn the block diagram of 8051 microcontroller.

Prof. Pitambar Humane

CO ORDINATOR
IQAC Coordinator
INTERNAL QUALITY ASSURANCE CELL
DHARAMPETH, M. P. DEO MEMORIAL &
SCIENCE COLLEGE, NAGPUR

Prof. V. V. Rangari

Head of the Department
Dr. V. V. Rangari
Professor & Head
Department of Electronics
Dharampeth, M.P. Deo Memorial
Science College, Nagpur

Dr. Akhilesh Peshwe

Principal
Principal
Dharampeth M.P. Deo Memorial
Science College, Nagpur.



DHARAMPETH M. P. DEO MEMORIAL SCIENCE COLLEGE, NAGPUR

Department of Electronics

Semester VI- (2022-23)

Activity (Paper II- Unit- I)

Sr. No.	Student Name	Mobile Number	Email Id
1	Aarti Brijkishor Singh	7709208740	aartibsingh222@gmail.com
2	Sakshi Sanjay Huddar	9405142450	huddarmahi@gmail.com
3	Tanmay Sunil Gadam	7262034396	tanmaygadaml@gmail.com
4	Samiksha Vasant Tabhane	9307133863	samikshavtabhane@gmail.com
5	Riddhi Abhay Rajkarne	8669809201	riddhirajkarne@gmail.com
6	Rani Devidas Kokate	7998945148	ranikokate1009@gmail.com
7	Bhavesh Rameshwar Maske	7489951631	bhaveshmaske2002@gmail.com
8	Megha Tribhuwan Bisen	9637770341	bisenmegha320@gmail.com
9	Kiran Ramesh Waghade	9860218676	rameshwaghade20@gmail.com
10	Sagar Omprakash Sonwane	9356591564	sagarsonwane706@gmail.com
11	Ankita Laxman Sonwane	9284801790	ankitasonwane10@gmail.com
12	Ankit Dilip Singh	9307189124	as4212892@gmail.com
13	Adesh Kamalkishor Dubey	9527898267	Adesh222@gmail.com
14	Ankur Singh	7507990175	akashdsingh059@gmail.com
15	Prathmesh Sanju Badhiye	9765262138	nikita24badhiye@gmail.com

Name & Signature of Teacher In-Charge

Name & Signature of Head of the Department

Prof. Pitambar Humane
IQAC Coordinator

CO ORDINATOR

INTERNAL QUALITY ASSURANCE CELL
DHARAMPETH M. P. DEO MEMORIAL &
SCIENCE COLLEGE, NAGPUR

Dr. Varsha V. Rangari
Professor & Head
Department of Electronics
Dharampeth M.P. Deo Memorial
Science College, Nagpur

Dr. Anandesh Peshwe
Principal

Principal
Dharampeth M.P. Deo Memorial
Science College, Nagpur.



DHARAMPETH M. P. DEO MEMORIAL SCIENCE COLLEGE, NAGPUR

INTERNAL QUALITY ASSURANCE CELL (IQAC)

Activity Report

Date: 06-02-2023

Name of Organizing Department or Committee: Department of Statistics.

Name of the activity: Construction of confidence interval for the mean of univariate normal distribution.

Suggested CRITERION point if any:

Date of Activity: 06th February 2023

Place of Activity: Statistics lab

Name of Guest Speaker/s or Judge/s or Chief Guest/s if any: N.A.

Title of the Activity: Construction of confidence interval for the mean of univariate normal distribution.

Number of Participants: 10

Name of the Teacher: Gauri Sinekar

Names of other Committee Members / Staff: N.A.

OUTCOME of the Activity with respect to mission vision of the institute and or academics:

The income data of workers of factory was given to the students. This data follows Univariate normal distribution. Student revised the topic of univariate normal distribution, the concept of confidence interval, and also tried to revise construction of confidence interval after understanding the question. Student found out the confidence interval i.e. upper and lower confidence limit of mean income of worker of in factory. After solving this activity, student got knowledge about confidence interval for the mean of univariate normal distribution.

Activity with newspaper coverage if any: No

Activity data save in PC of: Department of Statistics

Prof. Pitambar Humane
IQAC Coordinator

CO ORDINATOR
INTERNAL QUALITY ASSURANCE CELL
DHARAMPETH, M. P. DEO MEMORIAL &
SCIENCE COLLEGE, NAGPUR

Name & Signature of Teacher In-charge

Dr. Akhilesh Peshwe
Principal

PRINCIPAL
Dharampeth M. P. Deo Memorial
Science College, Nagpur.



NEP Activity Report

Date: -08 /02 / 2023

Name of Organizing Department or Committee - Chemistry

Name of the activity: NEP Activity (SEM II - PAPER-I-UNIT-4)-ACTIVITY-1

Suggested CRITERION point if any: Criterion -II

Date of Activity: 06/02/2023

Place of Activity: Chemistry Department

Name of Guest Speaker/s or Judge/s or Chief Guest/s if any: - Nil

Title of the Activity: COLLECT INFORMATION ABOUT OZONOLYSIS PROCESS.

Number of Participants: 46

Name of the Teacher In-charge / Convener - Dr. Tanishq Chaudhari

Names of other Committee Members / Staff - Dr. V.P. Meshram

OUTCOME of the Activity with respect to mission vision of the institute and or academics:

1. Students came to know that Ozone is a powerful oxidant, highly reactive toward compounds with high electron densities, such as lignin. It improves the production of second-generation biofuels such as ethanol, methane and hydrogen.

Activity with newspaper coverage if any: Nil

Activity data save in PC of - Chemistry Department

Note: Kindly share geotag photographs separately along with report on igacdsc2022@gmail.com

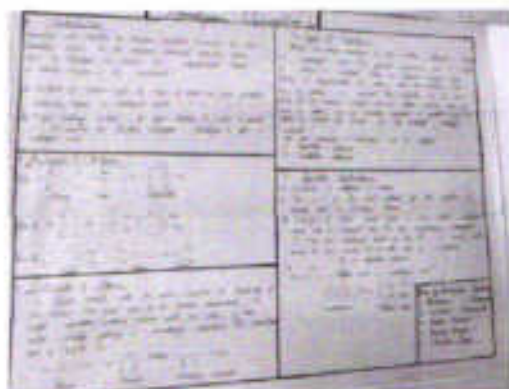

Prof. Pitambar Humane
IQAC Coordinator

CO ORDINATOR
INTERNAL QUALITY ASSURANCE CELL
DHARAMPETH, M. P. DEO MEMORIAL &
SCIENCE COLLEGE, NAGPUR

Dr. Tanishq Chaudhari
Name & Signature of Teacher In-charge

Dr. Akhilesh Peshwe
Principal

PRINCIPAL
Dharampeth M.P. Deo Memorial
Science College, Nagpur-440033

08/02/2023



DHARAMPETH M. P. DEO MEMORIAL SCIENCE COLLEGE,
North Ambazari Road, Near Ambazari Lake, Nagpur-440033

DATA VALIDATION & VERIFICATION (DVV)

(PAPER - I) (Unit-4)

Name of the Programme : NEP ACTIVITY-1: "Collect information about Ozonolysis process"
Date of the Programme : 06/02/2023.
Name of Chief Guest if any : -
Name of Guest Speaker if any : -

Sr. No.	Name of the Participant	Mobile Number	E-mail Id	Signature
1	Dhanashree Neware	9359909919	dhanashrineware786@gmail.com	
2	Krutika Pokale	9021533341	pokalekrutika6@gmail.com	
3	Priya B. Sharma	8010764599	priya13012004sharma@gmail.com	
4	Dhanashree V. Dhokane	7774900320	dhanashreevishwakarma@gmail.com	
5	Urmang. G. Wairthi	9322428500	urmangwairthi@gmail.com	
6	Kartika. M. Deshmukh	9649720460	Kartikad20@gmail.com	
7	Vaidehi P. Thete	7558499191	vaidehitete27@gmail.com	
8	Ritika. R. Sondwya	91755165	ritikasondwya@gmail.com	
9	Aarjya. S. Hussein	7066411418	husseinarjya805@gmail.com	
10	Somyak Hadke	707077304	Somyakhadke@gmail.com	

Signature of:

Programme In-charge

IQAC Coordinator

CO-ORDINATOR
INTERNAL QUALITY ASSURANCE CELL
DHARAMPETH, M. P. DEO MEMORIAL &
SCIENCE COLLEGE, NAGPUR

Principal

PRINCIPAL
Dharampeth M. P. Deo Memorial
Science College, Nagpur-440033



DHARAMPETH M. P. DEO MEMORIAL SCIENCE COLLEGE,
North Ambazari Road, Near Ambazari Lake, Nagpur- 440033

DATA VALIDATION & VERIFICATION (DVV)

Name of the Programme : NEP- ACTIVITY-1
Date of the Programme : _____
Name of Chief Guest if any : _____
Name of Guest Speaker if any : _____

Sr. No.	Name of the Participant	Mobile Number	E-mail Id	Signature
11	Ravindra Khadse	8007198273	khadse.ravindra.8926@gmail.com	
12	Anjali Thakre	7066554821	thakre.anjali.251@gmail.com	
13	Aakasha K. Khotbajade	7372228707	aakashakhotbajade@gmail.com	
14	Gunjan J. Bhoyrao	7666799586	gunjanbhoyrao@gmail.com	
15	Manthan M. Tolase	8080870430	manthanm.tolase@gmail.com	
16	Lucky A Vishwakarma	9579660386	lvishwakarma24@gmail.com	
17	Uman G. Warthi	9322428500	umangwarthi@gmail.com	
18	Vaidehi Thote	7558499191	vaidhi.thote.21@gmail.com	
19	Ritika R. Sondwya	9135581655	ritikasondwya@gmail.com	
20	Kastika M. Deshmukh	9699720960	kastikamc20@gmail.com	

Signature of:

Programme In-charge

IQAC Coordinator

Principal

CO ORDINATOR
INTERNAL QUALITY ASSURANCE CELL
DHARAMPETH, M. P. DEO MEMORIAL &
SCIENCE COLLEGE, NAGPUR

PRINCIPAL
Dharampeth M.P. Deo Memorial
Science College, Nagpur-440033



DHARAMPETH M. P. DEO MEMORIAL SCIENCE COLLEGE,
North Ambazari Road, Near Ambazari Lake, Nagpur- 440033

Som - 2.

DATA VALIDATION & VERIFICATION (DVV)

Name of the Programme : NEP - ACTIVITY-1

Date of the Programme : _____

Name of Chief Guest if any : _____

Name of Guest Speaker if any : _____

Sr. No.	Name of the Participant	Mobile Number	E-mail Id	Signature
21	Aparna Mohale	7020649887	opara1ohre2@gmail.com	
22	Komalika Chaudhari	9322033866	Komalikachaudhari73@gmail.com	
23	Apeksha Kotangale	7559455794	Apekshakotangale26@gmail.com	
24	Chandah K. Waghwani	7796016890	chandawani@gmail.com	
25	Usha Dhoke	9011681628	ujjanamata12@gmail.com	
26	Pranjali T. Raut	9322725233	pranjali.raut56@gmail.com	
27	Gransi R. Bhojwar	8668335876	gransirbhoyar34@gmail.com	
28	Yogita Degge	7058437240	yogita.degge@gmail.com	
29	Khushi K. Rewade	9588445994	khushikrewade@gmail.com	
30	Aakarishma Mairal	8010923662	aakarishmairala@gmail.com	

Signature of: Anaya borker
Aisha Pandey
Pranjali T. Raut

Programme In-charge

9168538614
8605431530
9322725233

IQAC Coordinator

anvay150715@gmail.com
adisheta8605291530@gmail.com
Pranjali Raut 56@gmail.com

CO ORDINATOR

INTERNAL QUALITY ASSURANCE CELL
DHARAMPETH M. P. DEO MEMORIAL &
SCIENCE COLLEGE, NAGPUR

Principal

PRINCIPAL

Dharampeth M. P. Deo Memorial
Science College, Nagpur-440033



DHARAMPETH M. P. DEO MEMORIAL SCIENCE COLLEGE,
North Ambazari Road, Near Ambazari Lake, Nagpur- 440033

DATA VALIDATION & VERIFICATION (DVV)

31	Nidu B. Rai	7058638984	nidu1419@gmail.com
32	Abhay P. Tembhare	8975363145	abhay30102@gmail.com
33	Aakansha. K. Khobragade	7972228707	aakanshakhobragade@gmail.com
34	Amisha. Aekare	766655911	amishaaekare@gmail.com
35	Sejal Kolhe	8483045989	Kolhesyadok@gmail.com
36	Gunjan I. Bhoyar	9666799586	gunjanbhoyar04@gmail.com
37	Charashree U. Dheman	7774900320	dhemancharashree@gmail.com
38	Kalyani R. Satham	8246939622	satham.kalyani@gmail.com
39	Aswini Hussain	7066411548	hussainaswini@gmail.com
40	Neha I. Kharjari	9373832266	nehakharjari93@gmail.com
41	Pranjali L. Meshram	7888080054	PranjaliMeshram85@gmail.com
42	Mounali D. Bhilkar	9322727616	MounaliBhilkar@gmail.com
43	Nihal V. Maham	8467792980	nihamaham@gmail.com
44	Sunaj Mishra	9230639023	sunajmishra9230@gmail.com
45	Aswini Hussain	7066411418	hussainaswini@gmail.com
46	Rashi Sapate	6195486583	rashisapate77@gmail.com

Signature of:

Programme In-charge

+

IQAC Coordinator

CO ORDINATOR
INTERNAL QUALITY ASSURANCE CELL
DHARAMPETH M. P. DEO MEMORIAL &

Principal

PRINCIPAL
Dharampeth M.P. Deo Memorial
Science College, Nagpur-440033



DHARAMPETH M. P. DEO MEMORIAL SCIENCE COLLEGE, NAGPUR
INTERNAL QUALITY ASSURANCE CELL (IQAC)

Activity Report

Date: 08/02/2023

Name of Organizing Department or Committee: Chemistry

Name of the activity: NEP activity report (Sem II, paper II, Unit II-Phase Rule)

Suggested CRITERION point if any: Criteria II

Date of Activity: 07-02-2023

Place of Activity: Department of Chemistry

Name of Guest Speaker/s or Judge/s or Chief Guest/s if any- Nil

Title of the Activity: Phase rule containing one component system example water system and its applications.

Number of Participants: 64

Name of the Teacher In-charge / Convener: Dr. Mrs. Yogita Morey (Dahire)

Names of other Committee Members / Staff: Dr. Mrs. V. P. Meshram

OUTCOME of the Activity with respect to mission vision of the institute and or academics:

This activity is made by students. This is a student's centric activity. Model making of water system helps the students to understand the concept of phase rule containing one component system. This can be easily visualised by the students and they can easily understand concept of phase rule.



Activity with newspaper coverage if any: Nil

Activity data saved in PC of: Chemistry Department

Note: Kindly share Jio tag photographs separately along with report on iqactsc2022@gmail.com

Prof. Pitambar Humane

IQAC Coordinator
PROF. PITAMBAR T. HUMANE
Head, Department of Botany
Dharampeth M. P. Deo Memorial
Science College, Nagpur-440033

Name & Signature of Teacher In-charge

Dr. Akhilesh Peshwe

Principal
PRINCIPAL
Dharampeth M. P. Deo Memorial
Science College, Nagpur.



DHARAMPETH M. P. DEO MEMORIAL SCIENCE COLLEGE,
North Ambazari Road, Near Ambazari Lake, Nagpur- 440033

DATA VALIDATION & VERIFICATION (DVV)

Name of the Programme : NEA Activity II (Sem II) Unit II (Phase Rule)
 Date of the Programme : Phase rule containing one component system example water
 Name of Chief Guest if any : System and its application
 Name of Guest Speaker if any : Date - 07-02-2023

Sr. No.	Name of the Participant	Mobile Number	E-mail Id	Signature
1.	Peanali Y. Chavhare	9699654582	peanali.chavhare09@gmail.com	
2.	Nisha Pandey	8605231390	abhishek.pandey.8605231390@gmail.com	
3.	Yachari Pandey	9156035297	pandey56@gmail.com	
4.	Priya Shewmal	8010964543	priyashewmal80@gmail.com	
5.	Anjali R. Thakre	7066554821	thakreanjul@gmail.com	
6.	Apeksha D. Katangale	7559455794	apekshaketangale20@gmail.com	
7.	Lucky A Vishwakarma	9579660186	lvishwakarma@200@gmail.com	
8.	Komalika S. Chaudhari	9322033866	Komalika.chaudhari073@gmail.com	
9.	Chanchal K. Waghwan	7796016894	waghwanitanu@gmail.com	
10.	Dhanashri Newar	9359909917	dhanashrinewar26@gmail.com	
11.	Krutika Pokate	9021533341	pokatekrutika6@gmail.com	
12.	Riya A. Singh	9595649831	riyaaas2307@gmail.com	
13.	Shreya A. Jha	8983236002	Sangeetajha@gmail.com	
14.	Aakamsha Y. Maizal	8010923662	aakamshay@gmail.com	

Signature of:
 Programme In-charge
Dr. Yogita Masrey (Deho)

IQAC Coordinator
CO ORDINATOR
 INTERNAL QUALITY ASSURANCE CELL
 DHARAMPETH M. P. DEO MEMORIAL &
 SCIENCE COLLEGE, NAGPUR

PRINCIPAL
 Dharampeth M.P. Deo Memorial
 Science College, Nagpur-440033



DHARAMPETH M. P. DEO MEMORIAL SCIENCE COLLEGE,
North Ambazari Road, Near Ambazari Lake, Nagpur- 440033

DATA VALIDATION & VERIFICATION (DVV)

15	Khushi Rewade	9588445994	KhushiRewade@gmail.com	Ayumi Roy
16	Vaishnavi N. Tonge	8421657943	Vaishnavi2004@gmail.com	Ayumi Roy
17	Gauri Bhoyar	8668335876	GauriBhoyar@gmail.com	Ayumi Roy
18	Yogita K. Thakore	7810206643	yogitathakore2584@gmail.com	Ayumi Roy
19	Nikhil Kumare	8999040961	kumare@gmail.com	Ayumi Roy
20	Pawan Thakore	8262969713	Thakore Pawan@gmail.com	Ayumi Roy
21	Phanjali L. Meshram	7888080054	Phanjalimeshram85@gmail.com	Ayumi Roy
22	Anvay Borikar	9168538614	Anvayborikar19@gmail.com	Ayumi Roy
23	Mounali D. Bhilkar	9322727616	MounaliBhilkar@gmail.com	Ayumi Roy
24	Divyadagde Tagde	7350090176	divyadagde868@gmail.com	Ayumi Roy
25	Kalyani P. Sindram	8446539622	kalyanisindram@gmail.com	Ayumi Roy
26	Anshul Y. Kishnapure	9284067169	anshulkishnapure650@gmail.com	Ayumi Roy
27	Neha Wanjari	9373832266	nehawanjari733@gmail.com	Ayumi Roy
28	Shivam U. Patel	7038889083	sp040263@gmail.com	Ayumi Roy
29	Pratibha B. Bhusari	7821048413	pbusari718@gmail.com	Ayumi Roy
30	Shruti Channekar	7720953263	shrutichannekar7009@gmail.com	Ayumi Roy
31	Gurjan Bhoyar	7666799586	gurjanbhoyar@gmail.com	Ayumi Roy
32	Amisha Astarkar	7666559171	Amishastarkar@gmail.com	Ayumi Roy
33	Ashiya Muscat	9359259741	Ashiyamuscat@gmail.com	Ayumi Roy
34	Akansha Khobragade	7972229700	Akanshakhobragade@gmail.com	Ayumi Roy
35	Priyanshu Raut	9322725238	Priyanshuraute@gmail.com	Ayumi Roy

Signature of:
 Programme In-charge:

Dr. Yogita Morey (Dahire)

ICAC Coordinator

CO ORDINATOR

INTERNAL QUALITY ASSURANCE UNIT
DHARAMPETH M. P. DEO MEMORIAL
SCIENCE COLLEGE, NAGPUR

Principal

PRINCIPAL

Dharampeth M.P. Deo Memorial
Science College, Nagpur-440033



DHARAMPETH M. P. DEO MEMORIAL SCIENCE COLLEGE,
North Ambazari Road, Near Ambazari Lake, Nagpur- 440033

DATA VALIDATION & VERIFICATION (DVV)

36	Pratibha B. bhuseari	7821048413	pbhuseari718@gmail.com	P.B.B
37	Shivam P. Patel	7038889083	sp040263@gmail.com	Shivam
38	Ankit R. Patel	9970905638	Ankitpatel997275@gmail.com	Ankit
39	Nihel V. Meshram	8767792960	nihelmeshram20@gmail.com	Nihel
40	Priyanshi L. Meshram	7888080054	Priyanshimeshram85@gmail.com	P.L. meshram
41	Kartika M. Deshmukh	9699720960	Kartikamd20@gmail.com	Kartika
42	Vaidhi Thote	7552444191	Vaidhitote@gmail.com	Vaidhi
43	Ritika Sonchiya	9175581655	ritikasonchiya@gmail.com	Ritika
44	Urmang Warthi	9322428500	urmangwarthi@gmail.com	Urmang
45	Monika J. Patel	7499225668	monikapatel7032@gmail.com	Monika
46	Shital O. Patil	9764596337	SP12@gmail.com	Shital
47	Siddhi Tiwari	8087143696	Siddhitiwari21@gmail.com	Siddhi
48	Muskan Kulkarni	9156889234	musankulkarni30@gmail.com	Muskan
49	Yogita Denge	7058437260	yogitadenge@gmail.com	Yogita
50	Arya Dhoke	9011681628	aryadhoke@gmail.com	Arya
51	Aparna Mahore	7020649887	aparnamahore@gmail.com	Aparna
52	Ravindra Khadse	8007198273	ravindrakhadse@gmail.com	Ravindra
53	Himashi Kulkarni	9665301444	Himashikulkarni20@gmail.com	Himashi
54	Abhay P. Tembare	8975363145	Abhaytembare@gmail.com	Abhay
55	Ashalesha Khadgi	7820929579	Ashaleshakhadgi@gmail.com	Ashalesha
56	Suraina Chichonde	8530970182	Surainachichonde@gmail.com	Suraina

Signature of: Programme In-charge

Dr. Yogita Morey (Dahire)

ICAC Coordinator
CO ORDINATOR

INTERNAL QUALITY ASSURANCE CELL
DHARAMPETH M. P. DEO MEMORIAL &
SCIENCE COLLEGE, NAGPUR

Principal
PRINCIPAL

Dharampeth M.P. Deo Memorial
Science College, Nagpur-440033



DHARAMPETH M. P. DEO MEMORIAL SCIENCE COLLEGE,
North Ambazari Road, Near Ambazari Lake, Nagpur- 440033

DATA VALIDATION & VERIFICATION (DVV)

57)	Ashwini R. Chaudhary	9699792732	chaudharyashwini287@gmail.com	A.R. Chaudhary
58)	Vaishali M. Sawase	7912925603	Vaishali Sawase1@gmail.com	Vaishali
60)	Shreya G. Bhimte	9637362811	shreyabhimte00@gmail.com	Shreya
61)	Khineshwari R. Pushptode	8624976072	khineshwaripushptode@gmail.com	Rh
62)	Chiranjiv. S. Gajbhaye	8329412694	Gajbhayed@gmail.com	Gajv
63)	Shrutika B. Pise	9322316336	shrutikapise67@gmail.com	Pise
64)	Arpita T. Kusram	5146162921	arpita.kusram@gmail.com	Arpita

Signature of:

Dr. Yogita Morey (Dahire)
Programme In-charge



IQAC Coordinator
CO ORDINATOR
INTERNAL QUALITY ASSURANCE CELL
DHARAMPETH, M. P. DEO MEMORIAL &
SCIENCE COLLEGE, NAGPUR



Principal
PRINCIPAL
Dharampeth M.P. Deo Memorial
Science College, Nagpur-440033



DHARAMPETH M. P. DEO MEMORIAL SCIENCE COLLEGE, NAGPUR

INTERNAL QUALITY ASSURANCE CELL (IQAC)

Activity Report

Date: 8th February 2023

Name of Organizing Department or Committee : Electronics Department

Name of the Activity : Poster making on communication system

Suggested CRITERION point if any : Suggested criteria II

Date of Activity : 8th February 2023

Place of Activity : Electronics Lab

Name of Guest Speaker/s or Judge/s or Chief Guest/s if any : Not applicable

Title of the Activity: Poster making on communication system

Based on Unit : 1(Paper I)

Class : Semester IV

Number of Participants : 17

Name of the Teacher In-charge / Convener: Prof. V. V. Rangari

OUTCOME of the Activity with respect to mission vision of the institute and or academics:

Students studied different elements of communication system. They also studied the block diagram of transmitter and receiver in communication system.

Prof. P. P. Peshwe
CO-ORDINATOR
INTERNAL QUALITY ASSURANCE CELL
DHARAMPETH M. P. DEO MEMORIAL &
SCIENCE COLLEGE, NAGPUR

Dr. Prof. V. V. Rangari
Professor & Head
Head of the Department
Department of Electronics
Dharampeth M. P. Deo Memorial
Science College, Nagpur

Dr. Akhilesh Peshwe
Principal
Dharampeth M. P. Deo Memorial
Science College, Nagpur.



DHARAMPETH M. P. DEO MEMORIAL SCIENCE COLLEGE, NAGPUR

Department of Electronics

Semester IV- (2022-23)

ACTIVITY (PAPER I – UNIT 3)

Sr. No.	Student Name	Mobile No.	Email ID
1	Janvi Ashok Kosarkar	8975756916	Janvikosarkar@gmail.com
2	Pratham Ankush Sitkare	9022553288	prathamsitkare@gmail.com
3	Jay Anilbhai Patil	7385436956	jay_patil0326@gmail.com
4	Urvashi Sunilrao Umathe	9527708361	pragatichaure01@gmail.com
5	Renuka Vishal Lande	7719951401	renukalande220@gmail.com
6	Rahul Ramesh Kawade	9359525716	kawaderahul042@gmail.com
7	Ankush Samma Gawade	7588194156	agawde5603@gmail.com
8	Yash Ravindra Khedekar	7020829422	yashkhedekar5@gmail.com
9	Prakhar Rajesh Buradkar	8329760853	prakhar.buradkar560@gmail.com
10	Bhagyarathi Ramvinay Pandey	9175302601	pandeybhagyarathi@gmail.com
11	Unnatital Chatrapal Chopde	9022627617	unnatichopde2002@gmail.com
12	Mansi Dilip Nandanwar	7709322027	mansinandanwar19@gmail.com
13	Aasmin Abdulkhalik Sheikh	8788490684	abdulkhalik563698@gmail.com
14	Tushar Wadhawe		
15	Prajwal Mulchand Bhade	9834016826	matesamu17@gmail.com
16	Durgesh Krishna Singh	7385310432	ds608531@gmail.com
17	Chetan Umashankar Bopche	9172484628	chetanbopche27@gmail.com

Name & Signature of Teacher In-Charge

Prof. Pitambar Humane
IQAC Coordinator

CO ORDINATOR
INTERNAL QUALITY ASSURANCE CELL
DHARAMPETH, M. P. DEO MEMORIAL &
SCIENCE COLLEGE, NAGPUR

Name & Signature of Head of the Department

Dr. Varsha V. Rangari
Professor & Head
Department of Electronics
Dharampeth M.P. Deo Memorial
Science College, Nagpur

Dr. Akhilesh Peshwe
Principal
Principal
Dharampeth M.P. Deo Memorial
Science College, Nagpur.



DHARAMPETH M. P. DEO MEMORIAL SCIENCE COLLEGE, NAGPUR

INTERNAL QUALITY ASSURANCE CELL (IQAC)

Activity Report

Date: 8th February 2023

Name of Organizing Department or Committee : Electronics Department
Name of the Activity : To study electrical characteristics of Transistor using datasheet
Suggested CRITERION point if any : Suggested criteria II
Date of Activity : 8th February 2023
Place of Activity : Electronics Lab

Name of Guest Speaker/s or Judge/s or Chief Guest/s if any : Not applicable
Title of the Activity: To study electrical characteristics of Transistor using datasheet
Based on Unit : 2(Paper I)
Class : Semester II
Number of Participants : 17

Name of the Teacher In-charge / Convener: Mrs. Leena P. Thakare

OUTCOME of the Activity with respect to mission vision of the institute and or academics:

Students studied the technical specifications and applications of 2N3902, 2N3903 using datasheet.

Prof. Binod Kumar
COORDINATOR
INTERNAL QUALITY ASSURANCE CELL
IQAC Coordinator
DHARAMPETH, M. P. DEO MEMORIAL &
SCIENCE COLLEGE, NAGPUR

Dr. Anjali V. Rengari
Professor & Head
Head of the Department
Department of Electronics
Dharampeth M.P. Deo Memorial
Science College, Nagpur

Dr. Adhilesh Pestwe
Principal
Principal
Dharampeth M.P. Deo Memorial
Science College, Nagpur.



DHARAMPETH M. P. DEO MEMORIAL SCIENCE COLLEGE, NAGPUR

Department of Electronics

Semester II- (2022-23)

Activity (Paper I - Unit- 2)

Sr. No.	Student Name	Mobile Number	Email ID
1	Tanu Ajay Singh	8806355808	tanusingh63492@gmail.com
2	Kashish Kamalkumar Bisen	7887886117	kashishbisen05@gmail.com
3	Khushi Rajiv Pali	8767607224	palikhushi4@gmail.com
4	Aayushi Vikram Singh	9595119942	senxerox04@gmail.com
5	Tannu Arun Varthi	9322044903	tannuvarthi@gmail.com
6	Bhagyashali Dadarao Neware	7796434177	sakshineware2017@gmail.com
7	Tejas Rajesh Chelmevar	9604662119	tejaschelmevar@gmail.com
8	Harshata Gunderao Warkhede	9860432428	bandukeshao20@gmail.com
9	Khushbu Rajiv Pali	8459565214	palikhushbu59@gmail.com
10	Tushal Rupkumar Achare	9075995617	acharetushal5@gmail.com
11	Simran Narendra Dhimole	8390347026	mishralaxmi210@gmail.com
12	Isha Ishwar Waghmare	8855919474	ishawaghmare9474@gmail.com
13	Vaidhavi Baburao Gongal	7507907278	gayatrigongal787@gmail.com
14	Vedant Onkar Umretkar	9049932753	umretkarvedant@gmail.com
15	Sandeep Rakesh Kumar Kumar	8081144948	sandeepk27900@gmail.com
16	Tannu Arun Varthi	9322044903	tannuvarthi@gmail.com
17	Abhishek Ravindra Singh	8208948107	abhi0882005@gmail.com

Name & Signature of Teacher In-Charge

Prof. Pitambar Humane
IQAC Coordinator

CO ORDINATOR
INTERNAL QUALITY ASSURANCE CELL
DHARAMPETH, M. P. DEO MEMORIAL &
SCIENCE COLLEGE, NAGPUR

Name & Signature of Head of the
Department

Dr. Varsha V. Rangari
Professor & Head
Department of Electronics
Dharampeth M.P. Deo Memorial
Science College, Nagpur

Dr. Akhilesh Peshwe
Principal

Dharampeth M.P. Deo Memorial
Science College, Nagpur.



NPN HIGH POWER SILICON TRANSISTOR

Qualified per MIL-PRF-19500/371

Devices

Qualified Level

2N3902

2N5157

JAN
JANTX

MAXIMUM RATINGS

Ratings	Symbol	2N3902	2N5157	Unit
Collector-Emitter Voltage	V_{CE0}	400	500	Vdc
Emitter-Base Voltage	V_{EB0}	5.0	6.0	Vdc
Collector-Base Voltage	V_{CB0}	700		Vdc
Base Current	I_B	2.0		Adc
Collector Current	I_C	3.5		Adc
Total Power Dissipation	P_T	① $T_A = +25^\circ\text{C}$ ⁽¹⁾		5.0
		② $T_C = +75^\circ\text{C}$ ⁽²⁾		100
Operating & Storage Temperature Range	T_J, T_{stg}	-65 to +200		$^\circ\text{C}$

THERMAL CHARACTERISTICS

Characteristics	Symbol	Max.	Unit
Thermal Resistance, Junction-to-Case	$R_{\theta JC}$	1.25	$^\circ\text{C/W}$

1) Derate linearly 29 mW/ $^\circ\text{C}$ for $T_A > +25^\circ\text{C}$

2) Derate linearly 0.8 W/ $^\circ\text{C}$ for $T_C > +75^\circ\text{C}$



*See Appendix A for Package Outline

ELECTRICAL CHARACTERISTICS

Characteristics	Symbol	Min.	Max.	Unit
-----------------	--------	------	------	------

OFF CHARACTERISTICS

Collector-Emitter Cutoff Current $V_{CE} = 325 \text{ Vdc}$ $V_{EB} = 400 \text{ Vdc}$	2N3902 2N5157	I_{CEO}	250 250	μAdc
Collector-Emitter Cutoff Current $V_{BE} = 1.5 \text{ Vdc}; V_{CE} = 700 \text{ Vdc}$		I_{CEX}	500	μAdc
Emitter-Base Cutoff Current $V_{EB} = 5.0 \text{ Vdc}$ $V_{CB} = 6.0 \text{ Vdc}$	2N3902 2N5157	I_{EB0}	200 200	μAdc

ON CHARACTERISTICS⁽³⁾

Base-Emitter Saturation Voltage $I_C = 1.0 \text{ Adc}; I_B = 0.1 \text{ Adc}$ $I_C = 3.5 \text{ Adc}; I_B = 0.7 \text{ Adc}$		$V_{BE(sat)}$	1.5 2.0	Vdc
Collector-Emitter Saturation Voltage $I_C = 1.0 \text{ Adc}; I_B = 0.1 \text{ Adc}$ $I_C = 3.5 \text{ Adc}; I_B = 0.7 \text{ Adc}$		$V_{CE(sat)}$	0.8 2.5	Vdc

6 Lake Street, Lawrence, MA 01841

1-800-446-1158 / (978) 794-1666 / Fax: (978) 689-0803

120101

Page 1 of 2

2N3902, 2N5157 JAN SERIES

ELECTRICAL CHARACTERISTICS (con't)

Characteristics	Symbol	Min.	Max.	Unit
ON CHARACTERISTICS⁽³⁾ (con't)				
Forward-Current Transfer Ratio $I_C = 0.5 \text{ A dc}; V_{CE} = 5.0 \text{ V dc}$ $I_C = 1.0 \text{ A dc}; V_{CE} = 5.0 \text{ V dc}$ $I_C = 2.5 \text{ A dc}; V_{CE} = 5.0 \text{ V dc}$ $I_C = 3.5 \text{ A dc}; V_{CE} = 5.0 \text{ V dc}$	h_{FE}	25 30 10 5	90	
Collector-Emitter Sustaining Voltage $I_C = 100 \text{ mA dc}$	$V_{CE(sust)}$	2N3902 2N5157	325 400	V dc

DYNAMIC CHARACTERISTICS

Small-Signal Short-Circuit Forward Current Transfer Ratio $I_C = 0.2 \text{ A dc}; V_{CE} = 10 \text{ V dc}; f = 1 \text{ MHz}$	$ h_{fe} $	2.5	25	
Output Capacitance $V_{CE} = 10 \text{ V dc}; I_C = 0; 100 \text{ kHz} \leq f \leq 1.0 \text{ MHz}$	C_{out}		250	pf

SWITCHING CHARACTERISTICS

Turn-On Time $V_{CE} = 125 \text{ V dc}; I_C = 1.0 \text{ A dc}; I_{B1} = 0.1 \text{ A dc}$	t_{on}		0.8	μs
Turn-Off Time $V_{CE} = 125 \text{ V dc}; I_C = 1.0 \text{ A dc}; I_{B1} = 0.1 \text{ A dc}; -I_{B2} = 0.50 \text{ A dc}$	t_{off}		1.7	μs

SAFE OPERATING AREA

DC Tests (continuous)				
$T_C = +25^\circ\text{C}; t \geq 1.0 \text{ s}$ (See Figure 3 of MIL-PRF-19500/371)				
Test 1				
$V_{CE} = 28.6 \text{ V dc}; I_C = 3.5 \text{ A dc}$				
Test 2				
$V_{CE} = 70 \text{ V dc}; I_C = 1.43 \text{ A dc}$				
Test 3				
$V_{CE} = 325 \text{ V dc}; I_C = 55 \text{ mA dc}$	2N3902			
$V_{CE} = 400 \text{ V dc}; I_C = 35 \text{ mA dc}$	2N5157			
Switching Tests				
Load condition C (unclamped inductive load)				
$T_C = 25^\circ\text{C}; \text{duty cycle} \leq 10\%; R_s = 0.1 \Omega$ (See Figure 4 of MIL-PRF-19500/371)				
Test 1				
$t_r = \text{approximately } 3 \text{ ns (vary to obtain } I_C); R_{B1} = 20 \Omega; V_{B1} = 10 \text{ V dc}; R_{B2} = 3 \text{ k}\Omega;$ $V_{B2} = 1.5 \text{ V dc}; V_{CE} = 50 \text{ V dc}; I_C = 3.5 \text{ A dc}; L = 60 \text{ mH}; R = 3 \Omega; R_s \leq 14\Omega.$				
Test 2				
$t_r = \text{approximately } 3 \text{ ns (vary to obtain } I_C); R_{B1} = 100 \Omega; V_{B1} = 10 \text{ V dc}; R_{B2} = 3 \text{ k}\Omega;$ $V_{B2} = 1.5 \text{ V dc}; I_C = 0.6 \text{ A dc}; V_{CE} = 50 \text{ V dc}; L = 200 \text{ mH}; R = 8 \Omega; R_s \leq 83\Omega.$				
Switching Tests				
Load condition (clamped inductive load)				
$T_C = +25^\circ\text{C}; \text{duty cycle} \leq 10\%$ (See Figure 5 of MIL-PRF-19500/371)				
Test 1				
$t_r = \text{approximately } 30 \text{ ns (vary to obtain } I_C); R_s = 0.1 \Omega; R_{B1} = 20 \Omega; V_{B1} = 10 \text{ V dc}; R_{B2} = 100 \Omega;$ $V_{B2} = 1.5 \text{ V dc}; V_{CE} = 50 \text{ V dc}; I_C = 3.5 \text{ A dc}; L = 60 \text{ mH}; R = 3 \Omega; R_s \geq 0\Omega.$ (A suitable clamping circuit or diode can be used.)				
Clamp Voltage = 400 +0, -5 V dc	2N3902			
Clamp Voltage = 500 +0, -5 V dc	2N5157			
(Clamped voltage must be reached)				

3.) Pulse Test: Pulse Width = 300 μs , Duty Cycle $\leq 2.0\%$

6 Lake Street, Lawrence, MA 01841

1-800-446-1158 / (978) 794-1666 / Fax: (978) 689-0803



DHARAMPETH M. P. DEO MEMORIAL SCIENCE COLLEGE, NAGPUR
DEPARTMENT OF COMPUTER SCIENCE
ACADEMIC SESSION: 2022-23

NOTICE

1/2//2023

All the students of B.Sc. are hereby informed that the Department of Computer Science, Dharampeth M.P.Deo Memorial Science College, Nagpur is going to One Day Workshop on Writing Scientific Research Article/Paper on 9/2/2023 . All the students interested students can registered their names to the Head Department of Computer Science

Venue : Computer Science Laboratory

Dr. Snehal Narale

Head, Department of Computer Science

Head,
Department of Computer Science
Dharampeth M. P. Deo Memorial
Science College, Nagpur

Dr. Akhilesh Peshwe

Principal
PRINCIPAL
Dharampeth M.P. Deo Memorial
Science College, Nagpur-440033



DIHARAMPETH M. P. DEO MEMORIAL SCIENCE COLLEGE, NAGPUR
INTERNAL QUALITY ASSURANCE CELL (IQAC)

Activity Report

Date: 10th February 2023

Name of Organizing Department or Committee: Computer Science Department

Name of the activity: One Day Workshop

Suggested CRITERION point if any: Criteria II,V

Date of Activity: 9/2/2023

Place of Activity: Computer Science Laboratory

Name of Guest Speaker/s or Judge/s or Chief Guest/s if any: Nil

Title of the Activity: "Writing Scientific Research Article/Paper"

Number of Participants: 32

Name of the Teacher In-charge / Convener: Dr.Mrs.Snehal Narale

Names of other Committee Members / Staff: Nil

OUTCOME of the Activity with respect to mission vision of the institute and or academics:

Conduction of such type of the workshop helps the students to create and develop their interest in the field of Research. Students get knowledge of research area and future scope in this area. They also understand the whole process of writing Article or Paper in their topic of interest of computer science or recent trends and technology in this subject. The workshop would helps the Students to choose the area of research.

Activity with newspaper coverage if any: Nil

Activity data save in PC of: Dr. Mrs. Snehal Narale's Laptop



Dr.Mrs.Snehal Narale

Name &Signature of Teacher In-charge

Prof.Pitambar Humane

IQAC Coordinator

CO ORDINATOR

INTERNAL QUALITY ASSURANCE CELL
DHARAMPETH, M. P. DEO MEMORIAL &
SCIENCE COLLEGE, NAGPUR

Dr.Akhilesh Peshwe

Principal

Principal

Dharampeth M. P. Deo Memorial
Science College, Nagpur



DHARAMPETH M. P. DEO MEMORIAL SCIENCE COLLEGE,
North Ambazari Road, Near Ambazari Lake, Nagpur - 480033

DATA VALIDATION & VERIFICATION (DVV)

Name of the Programme : Writing Research Article
Date of the Programme : 9/2/2023
Name of Chief Guest if any : _____
Name of Guest Speaker if any : _____

Sr. No.	Name of the Participant	Mobile Number	E-mail Id	Signature
1	Aditi Khurdekar Sem-2	9055328357	aditikhurdekar@gmail.com	Aditi
2	Jay Anilbhai Patil Sem-4	7385436956	jay.patil0926@gmail.com	Jay Patil
3	Anuj H. Mishra - Sem-4	8103656208	anujmishra2020@gmail.com	Anuj Mishra
4	Ashwini K. Shukla - Sem-4	9518994638	ashwiniashwini0025@gmail.com	Ashwini
5	Nitin K. Kumbhakar - Sem-4	9693429005	nitinkumbhakar73@gmail.com	Nitin
6	Pranali V. Gupta Sem-2	7020069377	pranali533@gmail.com	Pranali
7	Vansha I. Tunkar Sem-2	91373650950	vanshatunkar455@gmail.com	Vansha
8	Rutika G. Yadav (Sem-2)	8446085943	rutikayadav134@gmail.com	Rutika
9	Tanvi H. Laibet (Sem-2)	8446510539	Tanvulaibet@gmail.com	Tanvi
10	Tanvi Jage (Sem-2)	7385060871	Tanvi.Jage@gmail.com	Tanvi

Signature of

Program In-charge

Department of Computer Science
Dharampeth M. P. Deo Memorial
Science College, Nagpur

IQAC Coordinator

INTERNAL QUALITY ASSURANCE CELL
DHARAMPETH, M. P. DEO MEMORIAL
SCIENCE COLLEGE, NAGPUR

Principal

Dharampeth M. P. Deo Memorial
Science College, Nagpur



DHARAMPETH M. P. DEO MEMORIAL SCIENCE COLLEGE,
North Ambazari Road, Near Ambazari Lake, Nagpur-440033

DATA VALIDATION & VERIFICATION (DVV)

11)	Divyani V. Zagade [52]	9022866318	divyanizagade@gmail.com	Zagade
12)	Savitkha Panchbudhe [52]	9763075890	savitkshapanchbudhe363@gmail.com	Panch.
13)	Janvi Khode [52]	7385066634	Janvikhode892@gmail.com	Khode
14)	Khushbu G. Walimik	848340482	Khushbuwalimik@gmail.com	Walimik
15)	Sanchita . S. Patil	7218079076	sanchitapatil2003@gmail.com	Patil
16)	Nutan Surjuse	8805570279	nutansurjuse2@gmail.com	Surjuse
17)	Damini Katec	8208255685	daminiKatec81@gmail.com	Damini
18)	Vaishnavi Jadhav	9156916355	vg0806393@gmail.com	Jadhav
19)	Hemika . C. Mishra	906744577	hemikamishra@gmail.com	Mishra
20)	Amkumar D. Devangan	9163624388	amkumar12@gmail.com	Devangan
21)	Hitesh .G. kaurase	7058427112	hiteshkaurase73@gmail.com	Kaurase
22)	Rishabh . S. Naikam	7485039428	Rishabhnaikam@gmail.com	Naikam
23)	Vicky .A. Singh	9836782931	vickySingh11032001@gmail.com	Singh
24)	Adity kumar Singh	7350443901	AdityaSingh288180@gmail.com	A. K.S
25)	Suman . R. Singh	9322018536	sumanRsingh2345025@gmail.com	Singh

Signature of:

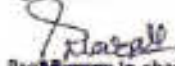
Professor in charge
Department of Computer Science
Dharampeth M. P. Deo Memorial
Science College, Nagpur



IQAC Coordinator
CO ORDINATOR
INTERNAL QUALITY ASSURANCE CELL
DHARAMPETH M. P. DEO MEMORIAL &
SCIENCE COLLEGE, NAGPUR



Principal
Dharampeth M. P. Deo Memorial
Science College, Nagpur



DHARAMPETH M. P. DEO MEMORIAL SCIENCE COLLEGE,
North Ambazari Road, Near Ambazari Lake, Nagpur-440033

DATA VALIDATION & VERIFICATION (DVV)

26	Sanit V. Gable	892410388	sanitv1250@gmail.com	Sanit
27	Isha Nemad	7028494761	ishanemada72@gmail.com	Ishanemada
28)	Maashal Ajinkal	9527732359	Maashalajinkal8@gmail.com	Maashal
29)	Arishka. Bhand	7820841788	arishkabhand82@gmail.com	A. Bhand
30)	Kunal S Dighe	8010276303	kunaldighe99@gmail.com	Kunal
31)	Bhagyashree S. Thatake	8766925275	thatakebhagyashree@gmail.com	Bhagyashree
32)	Devang Kucia	7888238500	Devang.kucia@gmail.com	Devang

Signature of:

[Signature]
Program In-Charge
Department of Computer Science
Dharampeth M. P. Deo Memorial
Science College, Nagpur

[Signature]

COAC Coordinator
INTERNAL QUALITY ASSURANCE CELL
DHARAMPETH M. P. DEO MEMORIAL &
SCIENCE COLLEGE, NAGPUR

[Signature]
Principal
Dharampeth M. P. Deo Memorial
Science College, Nagpur



DHARAMPETH M. P. DEO MEMORIAL SCIENCE COLLEGE, NAGPUR

INTERNAL QUALITY ASSURANCE CELL (IQAC)

Activity Report

Date:9/02/2023

Name of Organizing Department or Committee: Department of Mathematics

Name of the activity: NEP based To construct new examples on equation of sphere, circle for
B.Sc. Semester-II

Suggested CRITERION point if any: Criterion I.

Date of Activity: 9/02/2023

Place of Activity: Class room

Name of Guest Speaker/s or Judge/s or Chief Guest/s if any: NA

Title of the Activity: To construct new examples on equation of sphere, circle

Activity with newspaper coverage if any: No

Number of Participants: B.Sc. Semester-II Students (52)

Name of the Teacher In-charge / Convener: Dr. N. P. Gaikwad

Names of other Committee Members / Staff: Mr.Roshan Thakre

OUTCOME of the Activity with respect to academics:

The outcome of the activity is to easy to find the equation sphere and circle from given data point or radius.The use of the sphere and circle in technology and The equations are made for lot of applications in building structures, making simulators, calibrate vehicle sensors, estimate finance instruments

DVV: Enclosed.

Prof. Pitambar Humane

IQAC Coordinator

PRINCIPAL

Dharampeth M.P. Deo Memorial
Science College, Nagpur-440033

Name & Signature of Teacher In-charge

Dr. Akhilesh Peshwe

Principal

PRINCIPAL

Dharampeth M.P. Deo Memorial
Science College, Nagpur-440033

1

8/11



DHARAMPETH M. P. DEO MEMORIAL SCIENCE COLLEGE,
North Ambazari Road, Near Ambazari Lake, Nagpur- 440033

DATA VALIDATION & VERIFICATION (DVV)

Name of the Programme : NEP based To construct new examples on
 Date of the Programme : 9/02/2023 | equation of sphere, circle
 Name of Chief Guest if any : - | for B.Sc - Semester - II
 Name of Guest Speaker if any : -

Sr. No.	Name of the Participant	Mobile Number	E-mail Id	Signature
1.	Pravin Dhimale	7666330683	pravinandhimale80@gmail.com	Dhimale
2.	Abhishek Singh	8208948107	abhi0882005@gmail.com	Singh
3.	Pooja Singh	9527710350	poojasingh0012@gmail.com	P.Singh
4.	Vibhanshu Tajne	9561232204	vibhanshu0267@gmail.com	Vibhanshu
5.	Tejas Dongre	9322578918	Tej98744@gmail.com	Tejas
6.	Janvi Joge	7355060871	JanviJoge08@gmail.com	Janvi
7.	Janvi Laikar	8446510539	Janvikar04@gmail.com	Janvi
8.	Uday S. Unethkar	9049932753	unethkaruday@gmail.com	Uday
9.	Badal G. Somkuwar	7448247750	badal/somkuwar1@gmail.com	Badal
10.	Gindal B. Machade	912140728	nikhil/machade2008@gmail.com	Gindal

Signature of:

 Programme in-charge

IQAC Coordinator
 IQAC Co-ordinator
 Dharampeth M.P. Deo Memorial
 Science College, Nagpur-440033

Principal
 PRINCIPAL
 Dharampeth M.P. Deo Memorial
 Science College, Nagpur-440033



DHARAMPETH M. P. DEO MEMORIAL SCIENCE COLLEGE,
North Ambazari Road, Near Ambazari Lake, Nagpur- 440033

DATA VALIDATION & VERIFICATION (DVV)

11)	Pranali V. Gupta	7020069377	xy991537@gmail.com <u>Pranali</u>
12)	Jannu V. Khode	7385066634	Jannukhodes19@gmail.com <u>Jannu</u>
13)	Divyani Zagade	7022866318	divyani.zagade@gmail.com <u>Divyani</u>
14)	Sanniksha Panchubudhe	9763095890	sannikshapanchubudhe@gmail.com <u>Sanniksha</u>
15)	Sakshi Mishra	9529889315	Smishra939683@gmail.com <u>Sakshi</u>
16)	Jannu A. Karthi	9322044903	jannuvarthi@gmail.com <u>Jannu</u>
17)	Mounali Bhilkar	9322727616	mounalibhilkar@gmail.com <u>Mounali</u>
18)	Jisha S. Waghmare	885590479	jshawaghmare9474@gmail.com <u>Jisha</u>
19)	Tejas R. Chalmelwase	964662119	tejas.chalmelwase@gmail.com <u>Tejas</u>
20)	Pratiksha Boreve	9579836818	Pratikshaboreve49@gmail.com <u>Pratiksha</u>
21)	Mohit Khizdakar	8055328357	mohitkhizdakar@gmail.com <u>Mohit</u>
22)	Tanuja G. Yekute	9529547565	tanujayekute72@gmail.com <u>Tanuja</u>
23)	Mohima Khase	9545918678	mohimakhase11@gmail.com <u>Mohima</u>
24)	Varsha Tukkar	9373650950	varshatukkar48@gmail.com <u>Varsha</u>
25)	Ritika Yadav	8446085948	ritikayadav2014@gmail.com <u>Ritika</u>
26)	Bhagyashali D. Deware	7796434177	sakshineware2017@gmail.com <u>Bhagyashali</u>

Signature of:

Programme In-charge



IQAC Coordinator
IQAC Co-ordinator
Dharampeth M.P. Deo Memorial
Science College, Nagpur-440033



PRINCIPAL
Dharampeth M.P. Deo Memorial
Science College, Nagpur-440033



DHARAMPETH M. P. DEO MEMORIAL SCIENCE COLLEGE,
North Ambazari Road, Near Ambazari Lake, Nagpur- 440033

DATA VALIDATION & VERIFICATION (DVV)

27)	Nikhil Kade	9529113941	nikhilkade1803@gmail.com	
28)	Susma Dubey	7620170198	susmaofDubey144@gmail.com	
29)	Uday C. Bagnale	8459549609	bagnaleuday@gmail.com	
30)	Aniket J. Benuwka	9767219301	AniketBenuwka@gmail.com	
31)	Rohit Pandey	8767788703	TP9356521@gmail.com	
	Jushal Achare	9075995617	acharejushal@gmail.com	
	Aman Karm	9028837552	karm7817@gmail.com	
	Trushabh Saha	8087800294	trushabh.saha2004@gmail.com	
	Monu. P. Pal.	7350450579	monupal7350450@gmail.com	
	Uda			
	Prachi S. Gaikwad	7385612959	Prachigaikwad@gmail.com	
	Shrutika G. Pise	9322316336	shrutikapise67@gmail.com	
	Surej N. Mishra	9230639023	mishrasurej923063@gmail.com	
	Divyani G. Zade	7972403069	divyanizade2005@gmail.com	
	Jashvi Kisanpure	7407058235243	jashvikisanpure@gmail.com	
	Utkarsh Trigale	7499169178	utkarshtrigale@gmail.com	

Signature of:

Programme In-charge

IQAC Coordinator
IQAC Co-ordinator
Dharampeth M.P. Deo Memorial
Science College, Nagpur-440033

Principal
PRINCIPAL
Dharampeth M.P. Deo Memorial
Science College, Nagpur-440033



DHARAMPETH M P DEO MEMORIAL SCIENCE COLLEGE, NAGPUR



NATIONAL SERVICE SCHEME (NSS)

CAMP REPORT

From 9th to 15th February, 2023

As per the directives of Rashtrasant Tukadoji Maharaj Nagpur University, Nagpur, NSS Unit of Dharampeth M. P. Deo Memorial Science College, Nagpur organized NSS Camp at Neri (Mankar), Post: Wyahad, Tah.: Hingna, Dist.: Nagpur from 9th to 15th February, 2023. This place is 32 km away from Nagpur on Amravati Road. There were 100 NSS volunteers who participated in NSS Camp from B. Sc. Part-I, II & III and Home Science. Dr. P. T. Humane, Program Officer (NSS) and Dr. N. P. Gaikwad, Dr. Mrs. Varsha Rangari, Dr. Mrs. Shraddha Deshpande and Mrs. Ruma Kapre, Dr. Mrs. Kirti Paturkar and Lt. Dr. Prashant Ambekar worked hard for successful organization of this NSS Camp. The NSS Committee of the college visited three times the place of camp before its organization. The necessary arrangements were seen and arranged with the help of local people, Sarpanch and Z. P. Primary School teachers. Shri. Kamlakarji Aande, Shri. Anil Lohe, Shri. Sanay Wankhede, Shri. Kripal Sir, Shri. Ashish Lichade, etc. were assisted in survey of the village prior to organization of the camp.



On 9th of February, 2023 all the participants were assembled in college premises at 09:00am and after the official formalities at 10:30am all NSS volunteers with Dr. P. T. Humane (Program Officer, NSS) and Dr. N. P. Gaikwad, Dr. Mrs. Varsha Rangari, Shraddha Deshpande and Mrs. Ruma Kapre departed to Neri (Mankar). After one hour journey, all we reached at Neri (Mankar). On the first day, after reaching the camp place, the staff and students were taken their lunch. After the lunch all the arrangements were made for stay at Z. P. Primary School and Grampanchayat of Neri (Mankar).

The gender ratio of the country is highly imbalanced and hence there is necessity to increase the girl's number in the country. Keeping this in mind, the NSS volunteers have organised a rally on 'Beti Bachao Beti Padhao' in the village in evening.



To make the rally effective and to give proper message to the villagers regarding save girl child the following slogans were recited during the rally, *Beta beti ek saman, yehi to hai aapki shan; Beti kudrat ka hai uphar, isko jine ka do adhikar; Beti nahi to ma nahi, ma nahi to jivan nahi; Jab jab khadi uthi hai nari, har kisi pe padhi hai bhari; Beti bachao, beti padhao.*

Also, street play was organized in different places of the village to spread the awareness about importance of girl child. Around 15 students were participated in this street play.

A rally on blood donation camp was organized in the village and also blood donation camp in association with Hedgewar Blood Bank was organized. Many of the students, staff members and villagers participated in blood donation camp. Around 30 units of blood was collected during the camp. The facility of blood group identification, haemoglobin count, Blood Pressure (BP) count facilities were provided to the students as well as villagers during the blood donation camp. This will be helpful to save many lives as well as introduce the importance of blood donation among the students and villagers.



The students were taken for morning walk as well as Shramdan everyday as per the requirements of the village. In shramdan 'Swachchha Bharat Abhiyan' was organised. In this activity most of the areas of the village were cleaned by the students of NSS. A plastic free village were maintained during the

camp period including School and Grampanchayat premises. A rally was also arranged on 'Swachchha Bharat Abhiyan'. The following slogans were recited in the rally, Bapu ka ghar ghar pahuche sandesh, Swachchha aur sundar ho apna desh; Hum sabka yahi sapna, Swachchha Bharat ho apna; Dawayee se nata todo, Safayee se nata jodo; Desh apna saf ho, jisme sabka sath ho; Kadam se kadam milana hai, Bharat ko Swachchha banana hai.

In the evening time of the camp, cultural events were organized with the participation of NSS Volunteers as well as school children of the village. Many cultural events like, singing, dance, drama, etc. were organized during the cultural events of the camp.



During the camp floristic survey of the village was undertaken in association with Botany department of the college and more than 125 plant species of angiosperms were identified from the village only. The plants identified will be studied and sorted as per their nomenclature. The booklet form of the village flora will be presented to Sarpanch in next visit of the village.

Also, sickle cell detection camp was organized in association with zoology department of the college. Dr. Mrs. Kirti Paturkar, coordinated all the necessary arrangements to organize this camp in the village. The students spread the information about sickle cell detection camp in the village and school. During this camp, more than 150 students from the village as well as NSS Volunteers participated and took the advantage of this sickle cell detection camp.



All the participants of the camp were appreciated for their active participation in the camp by providing the certificate of participation during the camp.



The NSS volunteers of the camp have prepared various charts for the students of school from 1st to 7th and handed over to Head Mistress of the school during the concluding of the camp. The charts include languages, mathematics and science. Over 50 charts were prepared during the camp period.

The members of '*Mahila Bachat Gat*' were helped in various ways in the camp right from the first day to the end of the camp. They guided the students in purchasing the vegetables from the village and in day-to-day cooking. Their cooperation during the camp is highly appreciated.



The camp was concluded on 15th Feb., 2023 with a national anthem. All participants started the journey at 5:30pm and reached the college at 06:30pm.

Prof. Pitambar Humane
IQAC Coordinator

CO ORDINATOR
INTERNAL QUALITY ASSURANCE CELL
DHARAMPETH, M. P. DEO MEMORIAL &
SCIENCE COLLEGE, NAGPUR

Dr. Akhilesh Peshwe
Principal
Principal

Dharampeth M.P. Deo Memorial
Science College, Nagpur.



DHARAMPETH M. P. DEO MEMORIAL SCIENCE COLLEGE, NAGPUR
INTERNAL QUALITY ASSURANCE CELL (IQAC)

Activity Report (NEP: 2022-23)

Date: 28/2/23

Name of Organizing Department or Committee: Zoology
 Name of the activity: Data collection of insects in and around campus
 Suggested CRITERION point if any: Criteria I
 Date of Activity: 11/02/2023

Place of Activity: College campus

Name of Guest Speaker judge/s or Chief Guest/s if any: No

Title of the Activity: Data collection of insects in and around campus

Number of Participants: 16

Name of the Teacher In-charge / Convener: Dr. Snehal Dapke

Names of other Committee Members / Staff:

OUTCOME of the Activity with respect to mission vision of the institute and or academics:

- 1) Bird watching and insect watching refine skills in concentration
- 2) To observe, identify flora, fauna bird and insect in and around campus.
- 3) They are able to understand and importance of biodiversity.
- 4) This improves the bonding of students with nature which helps in conservation

Activity with newspaper coverage if any: NIL

Activity data save in PC of: Zoology Department/personal laptop



(Handwritten Signature)

Prof. Pitambar Humane
 IQAC Coordinator

CO ORDINATOR
INTERNAL QUALITY ASSURANCE CELL
DHARAMPETH, M. P. DEO MEMORIAL &
SCIENCE COLLEGE, NAGPUR

(Handwritten Signature)
 Name & Signature of Teacher In-charge

Dr. Akhilesh Peshwe
 Principal

Principal
 Dharampeth M. P. Deo Memorial
 Science College, NAGPUR



DHARAMPETH M. P. DEO MEMORIAL SCIENCE COLLEGE,
North Ambazari Road, Near Ambazari Lake, Nagpur- 440033

DATA VALIDATION & VERIFICATION (DVV)

Name of the Programme : Data collection of insects in and around college campus
Date of the Programme : 11/02/2023
Name of Chief Guest if any :
Name of Guest Speaker if any :

Sr.No.	Name of the Participant	Class/Semester	Mobile Number	E-mail Id	Signature	Remark
1)	Jyoti Sharma	Sem IV	8669736380	jjyotis8390@gmail.com	Jyoti Sharma	
2)	Bishwadevi Mishra	Sem IV	9579092931	bishwadevi.mishra123@gmail.com	Bishwadevi Mishra	
3)	Kalpna Suhagpure	Sem IV	9579236712	kalpnasuhagpure14@gmail.com	Kalpna Suhagpure	
4)	Uamila Bondre	Sem IV	9370673867	bondreumila.200@gmail.com	Uamila Bondre	
5)	Shravya Dhawale	Sem IV	9888264004	shravyadhawale.24@gmail.com	Shravya Dhawale	
6)	Vaishnavi Shende	Sem IV	8080640382	vaishnavishende.27@gmail.com	Vaishnavi Shende	
7)	Pooja Itankar	Sem IV	8156973252	poojaitankar387@gmail.com	Pooja Itankar	
8)	Dhanashree Newalkar	Sem IV	9356510280	dhanashree.newalkar@gmail.com	Dhanashree Newalkar	
9)	Chakuli Walikar	Sem IV	9325047907	chakuliwalikar@gmail.com	Chakuli Walikar	
10)	Mansi Raut	Sem IV	7385114931	mansiraut451@gmail.com	Mansi Raut	
11)	Vaishnavi Lakhe	Sem IV	8669594864	vaishnavilakhe@gmail.com	Vaishnavi Lakhe	
12)	Vaishnavi Khankate	Sem VI	8976328695	vaishnavikhankate@gmail.com	Vaishnavi Khankate	
13)	Srushti M. Gai	Sem VI	7385532705	srushtigaikwad8035@gmail.com	Srushti Gaikwad	
14)	Dhanashri Neware	Sem I	9259909913	dhanashriNeware786@gmail.com	Dhanashri Neware	
15)	Kautilka Pokale	Sem I	9025333411	pokalekautilka6@gmail.com	Kautilka Pokale	
16)	Gauri Bhojar	Sem I	8668385876	gauribhojar31@gmail.com	Gauri Bhojar	

Signature of
Programme in-charge

Signature of
CO ORDINATOR
INTERNAL QUALITY ASSURANCE CELL
DHARAMPETH, M. P. DEO MEMORIAL &
SCIENCE COLLEGE, NAGPUR

Signature of
Principal
Principal
Dharampeth M. P. Deo Memorial
Science College, NAGPUR



**DHARAMPETH M. P. DEO MEMORIAL SCIENCE COLLEGE, NAGPUR
INTERNAL QUALITY ASSURANCE CELL (IQAC)**

Activity Report

Date: 17/04/2023

Name of Organizing Department or Committee: Microbiology Department

Name of the activity: A project done by students on Snake and Ladder Game

Suggested CRITERION point if any: Criterion II and V

Date of Activity: 11th Feb 2023

Place of Activity: Laboratory of Microbiology

Name of Guest Speaker/s or Judge/s or Chief Guest/s if any: Guest Speaker- NA

Title of the Activity: Snake and Ladder Game on microbial diseases its control and preventive measures

Number of Participants: Eight

Name of the Teacher In-charge / Convener: Dr. Vidya R. Kathoke

Names of other Committee Members / Staff:

OUTCOME of the Activity with respect to mission vision of the institute and or academics:

This activity helps to enhance their interest of the subject and motivate them for reading books.

It helps the students to get deep knowledge about the subject

It helps to showcase their talents for preparation of charts as well as cooperation during work.



V. Kathoke
Dr. Vidya R. Kathoke
Name & Signature of Teacher In-charge

Pitambar Humane
Prof. Pitambar Humane
IQAC Coordinator

COORDINATOR
INTERNAL QUALITY ASSURANCE CELL
DHARAMPETH, M. P. DEO MEMORIAL
SCIENCE COLLEGE, NAGPUR

Dr. Akhilesh Peshwe
Principal

Principal
Dharampeth M. P. Deo Memorial
Science College, Nagpur



Dharampeth M.P. Deo Memorial science College, Nagpur

Academic Session: 2022-2023

DEPARTMENT OF MICROBIOLOGY

Date:08/02/2023

NOTICE

All the students of B.Sc. Semester II microbiology are hereby informed that a project making competition is organized by department of Microbiology. Those who are interested should give their names to Dr. V. R. Kathoke. The best selected project will be given prize.

Dr. Mrs. V. R. Kathoke
Teacher in-charge



DHARAMPETH M. P. DEO MEMORIAL SCIENCE COLLEGE,
North Ambazari Road, Near Ambazari Lake, Nagpur- 440033

DATA VALIDATION & VERIFICATION (DVV)

Name of the Programme : Snake and Ladder Game of Diseases
Date of the Programme : 11/02/2023
Name of Chief Guest if any : _____
Name of Guest Speaker if any : _____

Sr. No.	Name of the Participant	Mobile Number	E-mail Id	Signature
1.	Pranali Y. Chavhare (Sem II)	9699654562	pranalichavhare63@gmail.com	
2.	Pratiksha M. Meshram (Sem II)	8459070338	Meshrampratiksha14@gmail.com	
3.	Sharvani L. Umare (Sem II)	9284249534	sharvanicumare1912@gmail.com	
4.	Sagar S. Bawane (Sem II)	9975460979	sagarbawane637@gmail.com	
5.	Vaibhav A. Matkarni (Sem II)	8767838219	vaibhavmatkarni96@gmail.com	
6.	Kalyani C. Shahare (Sem II)	9307046378	Shaharekalyani5@gmail.com	
7.	Pratiksha Nougare (Sem II)	8623033760	Pratiksha944@gmail.com	
8.	Juhi S. Chaudhari (Sem II)	8669248944	chaudharijuhi12@gmail.com	

Signature of:

Programme In-charge

IQAC Coordinator

Principal



DHARAMPETH M. P. DEO MEMORIAL SCIENCE COLLEGE, NAGPUR

INTERNAL QUALITY ASSURANCE CELL (IQAC)

Activity Report

Date: 13-02-2023

Name of Organizing Department or Committee: Department of Statistics.

Name of the activity: Application of chi-square (χ^2) by analysing the contingency table
Suggested CRITERION point if any:

Date of Activity: 13th February 2023

Place of Activity: Statistics lab

Name of Guest Speaker/s or Judge/s or Chief Guest/s if any: N.A.

Title of the Activity: Application of chi-square (χ^2) by analysing the contingency table.
Number of Participants: 08

Name of the Teacher: Gauri Sinekar

Names of other Committee Members / Staff: N.A.

OUTCOME of the Activity with respect to mission vision of the institute and or academics:
The data based on employees category and bonus scheme was given to the students. Students revised the topic of chi-square (χ^2) and its application of chi-square (χ^2)-Contingency table. Student read and understood the question and also found out the result. Students got the knowledge about that how to analyse the data in contingency table.

Activity with newspaper coverage if any: No

Activity data save in PC of: Department of Statistics

Prof. Pitambar Humane
IQAC Coordinator

CO ORDINATOR
INTERNAL QUALITY ASSURANCE CELL
DHARAMPETH M. P. DEO MEMORIAL &
SCIENCE COLLEGE, NAGPUR

Name & Signature of Teacher In-charge

Dr. Akhilesh Peshwe
Principal

PRINCIPAL
Dharampeth M. P. Deo Memorial
Science College, Nagpur.



DHARAMPETH M. P. DEO MEMORIAL SCIENCE COLLEGE, NAGPUR
INTERNAL QUALITY ASSURANCE CELL (IQAC)
NEP Activity Report

Date: 15/02/2023

Name of Organizing Department or Committee: Chemistry

Name of the activity: NEP Activity Report (Sem IV, paper II, Unit II)

Suggested CRITERION point if any: Criteria II

Date of Activity: 13/02/2023

Place of Activity: Department of Chemistry

Name of Guest Speaker/s or Judge/s or Chief Guest/s if any: Nil

Title of the Activity: Identification of electrolytes

Number of Participants: 63

Name of the Teacher In-charge / Convener: Dr. Mrs. Mrudul R. Keskar

Names of other Committee Members / Staff: Dr. Mrs. V. P. Meshram

OUTCOME of the Activity with respect to mission vision of the institute and or academics:

This is a student's centric activity. Now students know about electrolytes like sodium, potassium, calcium, magnesium etc., identify them as strong or weak electrolytes, its types, and applications in different fields like, in industry it is used to extract and purify metals, useful to regulate body pH level, maintaining electrical neutrality in cells.



Activity with newspaper coverage if any: Nil

Activity data saved in PC of: Chemistry Department

Prof. Pitambar Humane
IQAC Coordinator

CO ORDINATOR
INTERNAL QUALITY ASSURANCE CELL
DHARAMPETH M. P. DEO MEMORIAL &
SCIENCE COLLEGE, NAGPUR

Mrudul Keskar
Name & Signature of Teacher In-charge
(Dr. Mrs. Mrudul R. Keskar)

Dr. Akhilesh Peshwe
Principal
PRINCIPAL

Dharampeth M.P. Deo Memorial
Science College, Nagpur-440033



DHARAMPETH M. P. DEO MEMORIAL SCIENCE COLLEGE,
North Ambazari Road, Near Ambazari Lake, Nagpur-440033
DATA VALIDATION & VERIFICATION (DVV)

Name of the Programme: NEP Activity - Identification of electrolytes (3em IV, Paper II, Unit II)
 Date of the Programme: 13-02-2023
 Name of Chief Guest if any: -
 Name of Guest Speaker if any: -

Sr. No.	Name of the Participant	Mobile Number	E-mail Id	Signature
1.	Juhi S. Chaudhari	8669248944	chaudharijuhi20@gmail.com	Juhi
2.	Sakshi S. Meshram	8145355733	sakshimeshram21@gmail.com	Sakshi
3.	Mansi I. Mate	8468891807	mansi19182@gmail.com	Mansi
4.	Jagruati D. Workar	7447366023	jagruatiworkar09@gmail.com	Jagruati
5.	Jyoti Sharma	8669736380	jyotise390@gmail.com	Jyoti
6.	Aman dougre	7709217312	amandougre2003@gmail.com	Aman
7.	Sania Raza	8975726700	saniamishra14@gmail.com	Sania
8.	Deshane Madavi	8830146516	deshanemadavi@gmail.com	Desha
9.	Vaishnavi Bedade	8830107397	vaishnavibedade10@gmail.com	Bedade
10.	Sejal R. Lakharpal	9028851568	sejal.lakharpal@gmail.com	Sejal
11.	Chirayu B. Dolat	8010135012	chirayudolat122@gmail.com	Chirayu
12.	Sagar S. Bawane	9975460979	sagurbawane637@gmail.com	Sagar
13.	Kajal P. Nighat	9373250629	kajalnighat2000@gmail.com	Kajal
14.	Kalpna Subagpure	9579236712	kalpanasubagpure7@gmail.com	Kalpna

INTERNAL USE ONLY
DHARAMPETH M. P. DEO MEMORIAL SCIENCE COLLEGE, NAGPUR

PRINCIPAL
Dharampeth M.P. Deo Memorial Science College, Nagpur-440033



DHARAMPETH M. P. DEO MEMORIAL SCIENCE COLLEGE,
North Ambazari Road, Near Ambazari Lake, Nagpur-440033

DATA VALIDATION & VERIFICATION (DVV)

15.	Shreya Sunil Chauhan	8888264004	Shreyachauhan24@gmail.com	
16.	Vaibhavi Amar Shende	8080640182	VaibhaviShende97@gmail.com	
17.	Vandana Vijay Bendre	9370673867	Bendrevandana1970@gmail.com	
18.	Niket Yuraj Thakre	7378899087	Niketthakre109@gmail.com	
19.	Rupesh Shukre	8805887370	RupeshShukre123@gmail.com	
20.	Poojaal Bhojare	8010434634	Poojaalb738@gmail.com	
21.	Harsh Kodape	9604677672	harshkodape008@gmail.com	
22.	Vaishnavi Gadge	9022976449	gadgavarshnavi@gmail.com	
23.	Aditya Dealkar	9028915716	dealkaraditya27@gmail.com	
24.)	Siddhanta G. Hikkane	9578092931	hikkane.siddhanta@gmail.com	
25.)	Rutik N. Gajbhiye	7620826960	rutikgajbhiye05@gmail.com	
26.)	Ritik M. Varma	8356744234	ritik0929@gmail.com	
27.)	Prashant Pandey	9998604684	pandeyprashant952@gmail.com	
28.)	Jasraj Pathwal	9370820825	Jasrajpathwal67@gmail.com	
29.)	Ashika Senyade.			

Signature of

Program In-charge

IQAC COORDINATOR
INTEGRATED QUALITY IMPROVEMENT CELL
DHARAMPETH M. P. DEO MEMORIAL &
SCIENCE COLLEGE, NAGPUR

Principal
PRINCIPAL
Dharampeth M.P. Deo Memorial
Science College - Nagpur-440033



DHARAMPETH M. P. DEO MEMORIAL SCIENCE COLLEGE,
North Ambazari Road, Near Ambazari Lake, Nagpur- 440033

DATA VALIDATION & VERIFICATION (DVV)

29	Ankita Mishra	mishraankita41083@gmail.com	8421993116	@ankita
30	Asmita Chureja	7387005732	asmitachureja@gmail.com	@chureja
31	Swati Longadje	8390516517	SwatiLongadje@gmail.com	Swati
32	Vaishnavi Kapse	8989751089	vaishnavikapse05@gmail.com	Vaishnavi
33	Devesh Longadje	9326240453	DeveshLongadje@gmail.com	Devesh
34	Vaibhav A. Malewar	8767838219	vaibhavmalewar74@gmail.com	V. Anand
35	Kalyani C. Shahare	9307046378	shaharekalyani5@gmail.com	Kalyani
36	Aanchal S. Singh	7875537925	SantoshSingh2392@gmail.com	Aanchal Singh
37	Nikita S. Bhave	7820812749	nikitabhava98@gmail.com	Nikita
38	Pratiksha S. Naugare	8623033760	PratikshaNaugare@gmail.com	P.S. Naugare
39	Shital G. Bankar	7758055139	shitalbankar122@gmail.com	SG. Bankar
40	Yashraj P. Chavde	9306354009	yashrajchavde@gmail.com	Yashraj
41	Khushabu H. Choudhary	7262074960	khushabuchoudhary88@gmail.com	Khushabu
42	Devashri D. Bisen	7773900643	DKBisen74@gmail.com	DBisen

Signature of:

Programme In-charge

CO-ORDINATOR
IQAC Coordinator
INTERNATIONAL ASSURANCE CELL
DHARAMPETH M. P. DEO MEMORIAL &
SCIENCE COLLEGE, NAGPUR

Principal
PRINCIPAL
Dharampeth M.P. Deo Memorial
Science College, Nagpur-440033



DHARAMPETH M. P. DEO MEMORIAL SCIENCE COLLEGE,
North Ambazari Road, Near Ambazari Lake, Nagpur - 440033

DATA VALIDATION & VERIFICATION (DVV)

43.	Ashesha Sangale	9503998469	Ashesha.sangale@gmail.com	Sangan
44.	Muskan Jadar			MS
45.	Nikita Bapat	7058025053	Prachibapat@gmail.com	Bapat
46.	Doly P. Sonkawade	7020616923	doly1910son@gmail.com	doly
47.	shital R. Khatkar	9373350711	shitalena@gmail.com	shpar
48.	Apurna Velankar	9623618911	Apurna.velankar@gmail.com	Apurna
49.	Ananya Matgare	7219212455	Ananyamatgar@gmail.com	Ananya
50.	Bhramika Thakare	7218211747	Bhramikathakare@gmail.com	Bhramika
51.	Vishakha Balubate	8329639862	Vishakhabalubate@gmail.com	Balubate
52.	Chakraborty Madhukar	9325047907	chakrabortymadhu@gmail.com	Chakraborty
53.	Hina Rahangadale	9921776769	Hinarahangadale@gmail.com	Hina
54.	Valshmani Lakhe	8669594864	chhalakhe@gmail.com	Chhalakhe
55.	Shymal D Nasse	9765943993	shymalnasse@gmail.com	Shymal
56.	SAMIR P. GHOME	9389236713	samerpghome2002@gmail.com	Samer
57.	Ketaki R. Kishpal	9112759066		Ketaki
58.	Smriti Vaidya	8856908764	smritivaidya@gmail.com	Smriti
59.	Anushree Chandel	9145635571		Anushree
60.	Gauri Raut	9767873447		Gauri
61.	Aadina Sheikh	8080083981	aadina@sheikh@gmail.com	Aadina
62.	Pranchal Meshram	7028735508		Pranchal
63.	Gaurav Landge	7767856082	Gaurav@gmail.com	Gaurav

Signature of Programme In-charge

ICAC Co-ordinator
DHARAMPETH M. P. DEO MEMORIAL SCIENCE COLLEGE, NAGPUR

PRINCIPAL
Dharampeth M. P. Deo Memorial Science College, Nagpur-440033



DHARAMPETH M. P. DEO MEMORIAL SCIENCE COLLEGE, NAGPUR

INTERNAL QUALITY ASSURANCE CELL (IQAC)

Activity Report

Date: 14th February 2023

Name of Organizing Department or Committee : Electronics Department

Name of the Activity : To study A/D and D/A IC's using datasheet

Suggested CRITERION point if any : Suggested criteria II

Date of Activity : 14th February 2023

Place of Activity : Electronics Lab

Name of Guest Speaker/s or Judge/s or Chief Guest/s if any : Not applicable

Title of the Activity: To study A/D and D/A IC's using datasheet

Based on Unit : 1(Paper II)

Class : Semester IV

Number of Participants : 17

Name of the Teacher In-charge / Convener: Mrs. Leena P. Thakare

OUTCOME of the Activity with respect to mission vision of the institute and or academics:

Students studied the technical specifications and applications of ADC0804 IC and DAC0800 IC using datasheet.

Prof. Pinalbhai S. Patil
COORDINATOR
INTERNAL QUALITY ASSURANCE CELL
IQAC Coordinator
DHARAMPETH, M. P. DEO MEMORIAL
SCIENCE COLLEGE, NAGPUR

Dr. Prof. Vignesh V. Rangari
Professor & Head
Head of the Department
Department of Electronics
Dharampeth M. P. Deo Memorial
Science College, Nagpur

Dr. Akhilesh Peshwe
Principal
Dharampeth M. P. Deo Memorial
Science College, Nagpur.



DHARAMPETH M. P. DEO MEMORIAL SCIENCE COLLEGE, NAGPUR

Department of Electronics

Semester IV- (2022-23)

ACTIVITY (PAPER II – UNIT 1)

Sr. No.	Student Name	Mobile No.	Email ID
1	Sadhana Mitaram Pardhi	9067539417	pradhishubhangi4@gmail.com
2	Yash Ravindra Khedekar	7020829422	yashkhedekar5@gmail.com
3	Ankush Samma Gawade	7588194156	agawde5603@gmail.com
4	Saurav Komalprasad Uikey	9356088871	sauravuikey6@gmail.com
5	Renuka Vishal Lande	7719951401	renukalande220@gmail.com
6	Priyanka Shilanath Shah	7796385608	rs3347310@gmail.com
7	Aasmin Abdulhalik Sheikh	8788490684	abdulhalik563698@gmail.com
8	Rahul Ramesh Kawade	9359525716	kawaderahul042@gmail.com
9	Urvashi Sunilrao Umathe	9527708361	pragatichaure01@gmail.com
10	Chetan Umashankar Bopche	9172484628	chetanbopche27@gmail.com
11	Unnatitai Chatrapal Chopde	9022627617	unnatichopde2002@gmail.com
12	Pratham Ankush Sitkare	9022553288	prathamsitkare@gmail.com
13	Mansi Dilip Nandanwar	7709322027	mansinandanwar19@gmail.com
14	Janvi Ashok Kosarkar	8975756916	Janvikosarkar@gmail.com
15	Bhagyarathi Ramvinay Pandey	9175302601	pandeybhagyarathi@gmail.com
16	Durgesh Krishna Singh	7385310432	ds608531@gmail.com
17	Sakshi Vinod Kanade	8806934839	Sakshikanade326@gmail.com

Name & Signature of Teacher In-Charge

Prof. Pitambar Humane
IQAC Coordinator

CO ORDINATOR
INTERNAL QUALITY ASSURANCE CELL
DHARAMPETH, M. P. DEO MEMORIAL &
SCIENCE COLLEGE, NAGPUR

Name & Signature of Head of the
Department

Prof. Vansha V. Rangari
Professor & Head
Department of Electronics
Dharampeth M.P. Deo Memorial
Science College, Nagpur

Dr. Akhilesh Peshwe
Principal
Principal
Dharampeth M.P. Deo Memorial
Science College, Nagpur.

ADC0802, ADC0803 ADC0804

8-Bit, Microprocessor-
Compatible, A/D Converters

August 1997

Features

- 80C48 and 80C80/85 Bus Compatible - No Interfacing Logic Required
- Conversion Time < 100 μ s
- Easy Interface to Most Microprocessors
- Will Operate in a "Stand Alone" Mode
- Differential Analog Voltage Inputs
- Works with Bandgap Voltage References
- TTL Compatible Inputs and Outputs
- On-Chip Clock Generator
- 0V to 5V Analog Voltage Input Range (Single +5V Supply)
- No Zero-Adjust Required

Description

The ADC0802 family are CMOS 8-Bit, successive-approximation A/D converters which use a modified potentiometric ladder and are designed to operate with the 8080A control bus via three-state outputs. These converters appear to the processor as memory locations or I/O ports, and hence no interfacing logic is required.

The differential analog voltage input has good common-mode-rejection and permits offsetting the analog zero-input-voltage value. In addition, the voltage reference input can be adjusted to allow encoding any smaller analog voltage span to the full 8 bits of resolution.

Ordering Information

PART NUMBER	ERROR	EXTERNAL CONDITIONS	TEMP. RANGE (°C)	PACKAGE	PKG. NO
ADC0802LCN	$\pm 1/2$ LSB	$V_{REF/2} = 2.500V_{DC}$ (No Adjustments)	0 to 70	20 Ld PDIP	E20.3
ADC0802LCD	$\pm 3/4$ LSB		-40 to 85	20 Ld Cerdip	F20.3
ADC0802LD	± 1 LSB		-55 to 125	20 Ld Cerdip	F20.3
ADC0803LCN	$\pm 1/2$ LSB	$V_{REF/2}$ Adjusted for Correct Full Scale Reading	0 to 70	20 Ld PDIP	E20.3
ADC0803LCD	$\pm 3/4$ LSB		-40 to 85	20 Ld Cerdip	F20.3
ADC0803LCWM	± 1 LSB		-40 to 85	20 Ld SOIC	M20.3
ADC0803LD	± 1 LSB		-55 to 125	20 Ld Cerdip	F20.3
ADC0804LCN	± 1 LSB	$V_{REF/2} = 2.500V_{DC}$ (No Adjustments)	0 to 70	20 Ld PDIP	E20.3
ADC0804LCD	± 1 LSB		-40 to 85	20 Ld Cerdip	F20.3
ADC0804LCWM	± 1 LSB		-40 to 85	20 Ld SOIC	M20.3

Pinout

ADC0802, ADC0803, ADC0804
(PDIP, CERDIP)
TOP VIEW

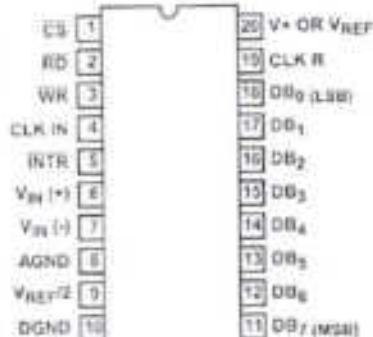

Typical Application Schematic

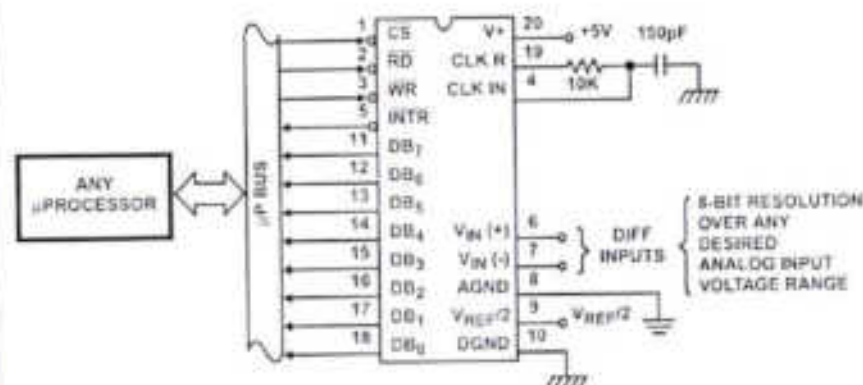

CAUTION: These devices are sensitive to electrostatic discharge; follow proper IC Handling Procedures.
1-888-INTERSIL or 321-724-7143 | Copyright © Intersil Corporation, 1999

File Number 3094.1

ADC0802, ADC0803, ADC0804

Electrical Specifications (Notes 1, 7) (Continued)

PARAMETER	TEST CONDITIONS	MIN	TYP	MAX	UNITS
CONVERTER SPECIFICATIONS $V^+ = 5V$, $-55^{\circ}C$ to $125^{\circ}C$ and $f_{CLK} = 640kHz$, Unless Otherwise Specified					
Total Unadjusted Error					
ADC0802	$V_{REF}/2 = 2.500V$	-	-	± 1	LSB
ADC0803	$V_{REF}/2$ Adjusted for Correct Full Scale Reading	-	-	± 1	LSB
$V_{REF}/2$ Input Resistance	Input Resistance at Pin 9	1.0	1.3	-	k Ω
Analog Input Voltage Range	(Note 2)	GND-0.05	-	$(V^+) + 0.05$	V
DC Common-Mode Rejection	Over Analog Input Voltage Range	-	$\pm 1/8$	$\pm 1/4$	LSB
Power Supply Sensitivity	$V^+ = 5V \pm 10%$ Over Allowed Input Voltage Range	-	$\pm 1/8$	$\pm 1/4$	LSB
AC TIMING SPECIFICATIONS $V^+ = 5V$, and $T_A = 25^{\circ}C$, Unless Otherwise Specified					
Clock Frequency, f_{CLK}	$V^+ = 6V$ (Note 3)	100	640	1280	kHz
	$V^+ = 5V$	100	640	800	kHz
Clock Periods per Conversion (Note 4), t_{CDW}		62	-	73	Clocks/Conv
Conversion Rate in Free-Running Mode, CR	INTR tied to WR with CS = 0V, $f_{CLK} = 640kHz$	-	-	8888	Conv/s
Width of WR Input (Start Pulse Width), $t_{W(WR)}$	CS = 0V (Note 5)	100	-	-	ns
Access Time (Delay from Falling Edge of RD to Output Data Valid), t_{ACC}	$C_L = 100pF$ (Use Bus Driver IC for Larger C_L)	-	135	200	ns
Three-State Control (Delay from Rising Edge of RD to HI-Z State), $t_{H, QH}$	$C_L = 10pF$, $R_L = 10K$ (See Three-State Test Circuits)	-	125	250	ns
Delay from Falling Edge of WR to Reset of INTR, $t_{W, IQ}$		-	300	450	ns
Input Capacitance of Logic Control Inputs, C_{IN}		-	5	-	μF
Three-State Output Capacitance (Data Buffers), C_{OUT}		-	5	-	μF
DC DIGITAL LEVELS AND DC SPECIFICATIONS $V^+ = 5V$, and T_{MIN} to T_{MAX} , Unless Otherwise Specified					
CONTROL INPUTS (Note 6)					
Logic "1" Input Voltage (Except Pin 4 CLK IN), V_{IH}	$V^+ = 5.25V$	2.0	-	V^+	V
Logic "0" Input Voltage (Except Pin 4 CLK IN), V_{IL}	$V^+ = 4.75V$	-	-	0.8	V
CLK IN (Pin 4) Positive Going Threshold Voltage, V^+_{CLK}		2.7	3.1	3.5	V
CLK IN (Pin 4) Negative Going Threshold Voltage, V^-_{CLK}		1.5	1.6	2.1	V
CLK IN (Pin 4) Hysteresis, V_H		0.6	1.3	2.0	V
Logic "1" Input Current (All Inputs), I_{IH}	$V_{IN} = 5V$	-	0.005	1	μA
Logic "0" Input Current (All Inputs), I_{ILO}	$V_{IN} = 0V$	-1	-0.005	-	μA
Supply Current (Includes Ladder Current), I^+	$f_{CLK} = 640kHz$, $T_A = 25^{\circ}C$ and CS = HI	-	1.3	2.5	mA
DATA OUTPUTS AND INTR					
Logic "0" Output Voltage, V_{OL}	$I_O = 1.6mA$, $V^+ = 4.75V$	-	-	0.4	V

ADC0802, ADC0803, ADC0804

Electrical Specifications (Notes 1, 7) (Continued)

PARAMETER	TEST CONDITIONS	MIN	TYP	MAX	UNITS
Logic "1" Output Voltage, V_{OH}	$I_O = -360\mu A$, $V^+ = 4.75V$	2.4	-	-	V
Three-State Disabled Output Leakage (All Data Buffers), I_{LO}	$V_{OUT} = 0V$	-3	-	-	μA
	$V_{OUT} = 5V$	-	-	3	μA
Output Short Circuit Current, I_{SOURCE}	V_{OUT} Short to Gnd $T_A = 25^\circ C$	4.5	6	-	mA
Output Short Circuit Current, I_{SINK}	V_{OUT} Short to V^+ $T_A = 25^\circ C$	8.0	16	-	mA

NOTES

- All voltages are measured with respect to GND, unless otherwise specified. The separate AGND point should always be wired to the DGND, being careful to avoid ground loops.
- For $V_{IN(i)} \geq V_{IN(j)}$ the digital output code will be 0000 0000. Two on-chip diodes are tied to each analog input (see Block Diagram) which will forward conduct for analog input voltages one diode drop below ground or one diode drop greater than the V^+ supply. Be careful during testing at low V^+ levels (4.5V), as high level analog inputs (5V) can cause this input diode to conduct - especially at elevated temperatures, and cause errors for analog inputs near full scale. As long as the analog V_{IN} does not exceed the supply voltage by more than 50mV, the output code will be correct. To achieve an absolute 0V to 5V input voltage range will therefore require a minimum supply voltage of 4.950V over temperature variations, initial tolerance and loading.
- With $V^+ = 5V$, the digital logic interfaces are no longer TTL compatible.
- With an asynchronous start pulse, up to 8 clock periods may be required before the internal clock phases are proper to start the conversion process.
- The \overline{CS} input is assumed to bracket the \overline{WR} strobe input so that timing is dependent on the \overline{WR} pulse width. An arbitrarily wide pulse width will hold the converter in a reset mode and the start of conversion is initiated by the low to high transition of the \overline{WR} pulse (see Timing Diagrams).
- CLK IN (pin 4) is the input of a Schmitt trigger circuit and is therefore specified separately.
- None of these A/Ds requires a zero-adjust. However, if an all zero code is desired for an analog input other than 0V, or if a narrow full scale span exists (for example: 0.5V to 4V full scale) the $V_{REF(-)}$ input can be adjusted to achieve this. See the Zero Error description in this data sheet.

Timing Waveforms

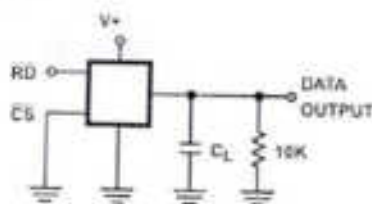

FIGURE 1A. t_{1H}

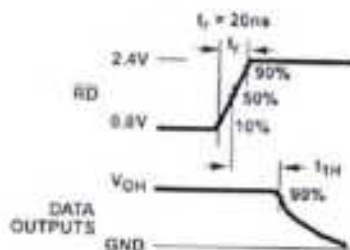

FIGURE 1B. t_{1H} , $C_L = 10pF$

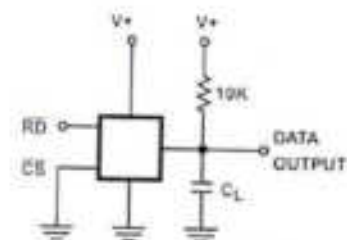

FIGURE 1C. t_{0H}

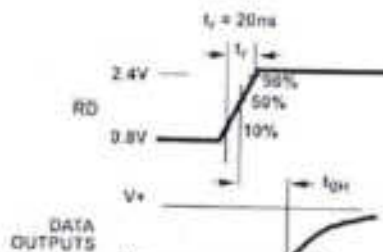

FIGURE 1D. t_{0H} , $C_L = 10pF$

FIGURE 1. THREE-STATE CIRCUITS AND WAVEFORMS

Typical Performance Curves (Continued)

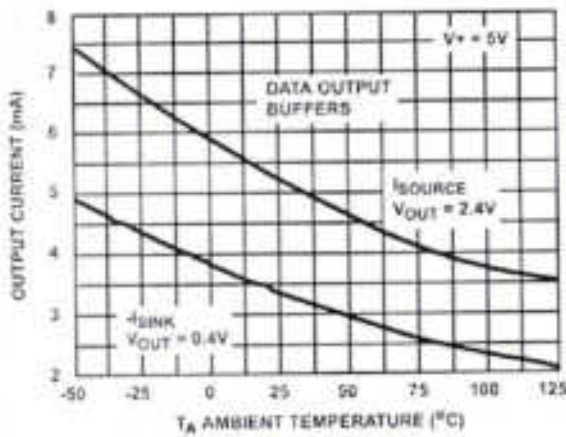

FIGURE 8. OUTPUT CURRENT vs TEMPERATURE

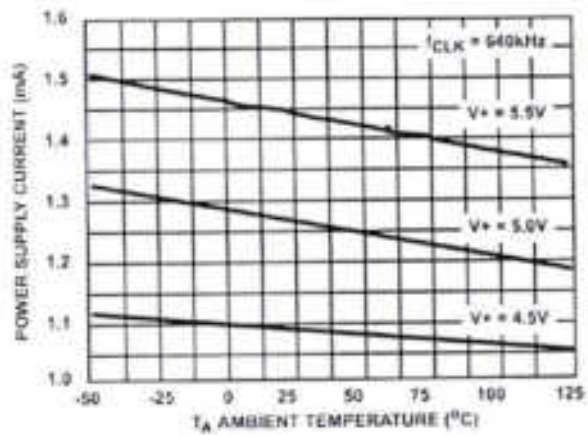

FIGURE 9. POWER SUPPLY CURRENT vs TEMPERATURE

Timing Diagrams

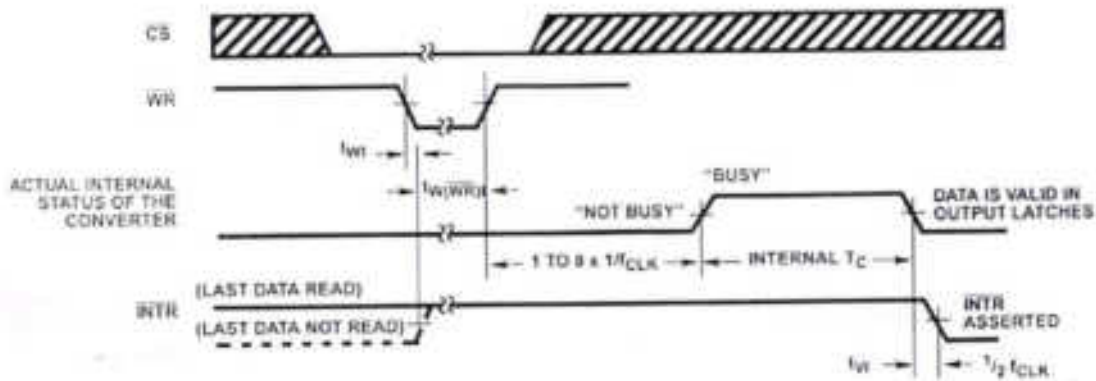

FIGURE 10A. START CONVERSION

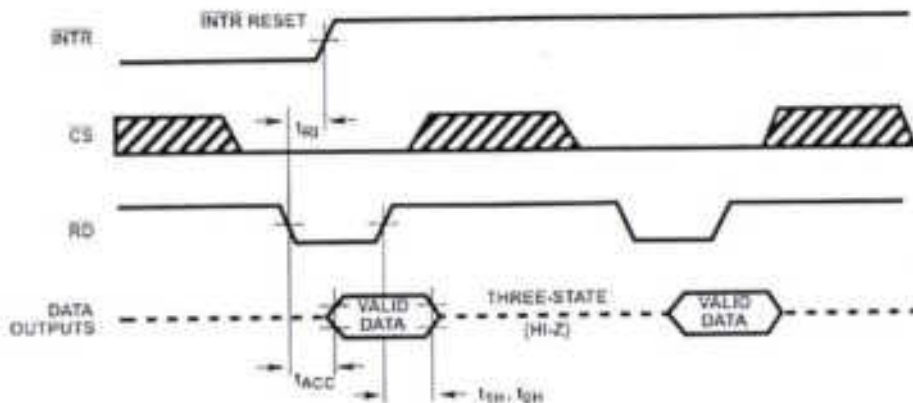

FIGURE 10B. OUTPUT ENABLE AND RESET INTR

The device may be operated in the free-running mode by connecting INTR to the WR input with CS = 0. To ensure start-up under all possible conditions, an external WR pulse is required during the first power-up cycle. A conversion-in-progress can be interrupted by issuing a second start command.

Digital Operation

The converter is started by having CS and WR simultaneously low. This sets the start flip-flop (F/F) and the resulting "1" level resets the 8-bit shift register, resets the Interrupt (INTR) F/F and inputs a "1" to the D flip-flop, DFF1, which is at the input end of the 8-bit shift register. Internal clock signals then transfer this "1" to the Q output of DFF1. The AND gate, G1, combines this "1" output with a clock signal to provide a reset signal to the start F/F. If the set signal is no longer present (either WR or CS is a "1"), the start F/F is reset and the 8-bit shift register then can have the "1" clocked in, which starts the conversion process. If the set signal were to still be present, this reset pulse would have no effect (both outputs of the start F/F would be at a "1" level) and the 8-bit shift register would continue to be held in the reset mode. This allows for asynchronous or wide CS and WR signals.

After the "1" is clocked through the 8-bit shift register (which completes the SAR operation) it appears as the input to DFF2. As soon as this "1" is output from the shift register, the AND gate, G2, causes the new digital word to transfer to the Three-State output latches. When DFF2 is subsequently clocked, the Q output makes a high-to-low transition which causes the INTR F/F to set. An inverting buffer then supplies the INTR output signal.

When data is to be read, the combination of both CS and RD being low will cause the INTR F/F to be reset and the three-state output latches will be enabled to provide the 8-bit digital outputs.

Digital Control Inputs

The digital control inputs (CS, RD, and WR) meet standard TTL logic voltage levels. These signals are essentially equivalent to the standard A/D Start and Output Enable control signals, and are active low to allow an easy interface to microprocessor control buses. For non-microprocessor based applications, the CS input (pin 1) can be grounded and the standard A/D Start function obtained by an active low pulse at the WR input (pin 3). The Output Enable function is achieved by an active low pulse at the RD input (pin 2).

Analog Operation

The analog comparisons are performed by a capacitive charge summing circuit. Three capacitors (with precise ratioed values) share a common node with the input to an auto-zeroed comparator. The input capacitor is switched between $V_{IN(+)}$ and $V_{IN(-)}$, while two ratioed reference capacitors are switched between taps on the reference voltage divider string. The net charge corresponds to the weighted difference between the input and the current total value set by the successive approximation register. A correction is made to offset the comparison by $1/2$ LSB (see Figure 11A).

Analog Differential Voltage Inputs and Common-Mode Rejection

This A/D gains considerable applications flexibility from the analog differential voltage input. The $V_{IN(-)}$ input (pin 7) can be used

to automatically subtract a fixed voltage value from the input reading (tare correction). This is also useful in 4mA - 20mA current loop conversion. In addition, common-mode noise can be reduced by use of the differential input.

The time interval between sampling $V_{IN(+)}$ and $V_{IN(-)}$ is $4\frac{1}{2}$ clock periods. The maximum error voltage due to this slight time difference between the input voltage samples is given by:

$$\Delta V_E(\text{MAX}) = (V_{\text{PEAK}})(2\pi f_{\text{CM}}) \left[\frac{4.5}{f_{\text{CLK}}} \right]$$

where:

ΔV_E is the error voltage due to sampling delay.

V_{PEAK} is the peak value of the common-mode voltage.

f_{CM} is the common-mode frequency.

For example, with a 60Hz common-mode frequency, f_{CM} , and a 640kHz A/D clock, f_{CLK} , keeping this error to $1/4$ LSB ($\sim 5\text{mV}$) would allow a common-mode voltage, V_{PEAK} , given by:

$$V_{\text{PEAK}} = \frac{[\Delta V_E(\text{MAX}) + f_{\text{CLK}}]}{(2\pi f_{\text{CM}})(4.5)}$$

or

$$V_{\text{PEAK}} = \frac{(5 \times 10^{-3})(640 \times 10^3)}{(6.28)(60)(4.5)} = 1.9\text{V}$$

The allowed range of analog input voltage usually places more severe restrictions on input common-mode voltage levels than this.

An analog input voltage with a reduced span and a relatively large zero offset can be easily handled by making use of the differential input (see Reference Voltage Span Adjust).

Analog Input Current

The internal switching action causes displacement currents to flow at the analog inputs. The voltage on the on-chip capacitance to ground is switched through the analog differential input voltage, resulting in proportional currents entering the $V_{IN(+)}$ input and leaving the $V_{IN(-)}$ input. These current transients occur at the leading edge of the internal clocks. They rapidly decay and do not inherently cause errors as the on-chip comparator is strobed at the end of the clock period.

Input Bypass Capacitors

Bypass capacitors at the inputs will average these charges and cause a DC current to flow through the output resistances of the analog signal sources. This charge pumping action is worse for continuous conversions with the $V_{IN(+)}$ input voltage at full scale. For a 640kHz clock frequency with the $V_{IN(+)}$ input at 5V, this DC current is at a maximum of approximately 5 μA . Therefore, **bypass capacitors should not be used at the analog inputs or the $V_{\text{REF}/2}$ pin** for high resistance sources ($>1\text{k}\Omega$). If input bypass capacitors are necessary for noise filtering and high source resistance is desirable to minimize capacitor size, the effects of the voltage drop across this input resistance, due to the average value of the input current, can be compensated by a full scale adjustment while the given source resistor and input bypass capacitor are both in place. This is possible because the average value of the input current is a precise linear function of the differential input voltage at a constant conversion rate.

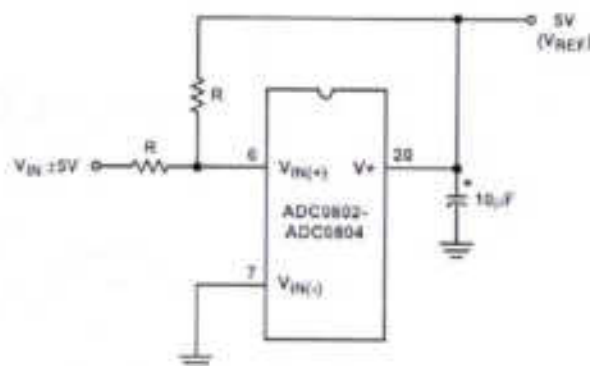

FIGURE 15. HANDLING ±5V ANALOG INPUT RANGE

Reference Accuracy Requirements

The converter can be operated in a pseudo-ratiometric mode or an absolute mode. In ratiometric converter applications, the magnitude of the reference voltage is a factor in both the output of the source transducer and the output of the A/D converter and therefore cancels out in the final digital output code. In absolute conversion applications, both the initial value and the temperature stability of the reference voltage are important accuracy factors in the operation of the A/D converter. For $V_{REF}/2$ voltages of 2.5V nominal value, initial errors of $\pm 10\text{mV}$ will cause conversion errors of ± 1 LSB due to the gain of 2 of the $V_{REF}/2$ input. In reduced span applications, the initial value and the stability of the $V_{REF}/2$ input voltage become even more important. For example, if the span is reduced to 2.5V, the analog input LSB voltage value is correspondingly reduced from 20mV (5V span) to 10mV and 1 LSB at the $V_{REF}/2$ input becomes 5mV. As can be seen, this reduces the allowed initial tolerance of the reference voltage and requires correspondingly less absolute change with temperature variations. Note that spans smaller than 2.5V place even tighter requirements on the initial accuracy and stability of the reference source.

In general, the reference voltage will require an initial adjustment. Errors due to an improper value of reference voltage appear as full scale errors in the A/D transfer function. IC voltage regulators may be used for references if the ambient temperature changes are not excessive.

Zero Error

The zero of the A/D does not require adjustment. If the minimum analog input voltage value, $V_{IN(MIN)}$, is not ground, a zero offset can be done. The converter can be made to output 0000 0000 digital code for this minimum input voltage by biasing the A/D $V_{IN(-)}$ input at this $V_{IN(MIN)}$ value (see Applications section). This utilizes the differential mode operation of the A/D.

The zero error of the A/D converter relates to the location of the first riser of the transfer function and can be measured by grounding the $V_{IN(-)}$ input and applying a small magnitude positive voltage to the $V_{IN(+)}$ input. Zero error is the difference between the actual DC input voltage which is necessary to just cause an output digital code transition from 0000 0000 to 0000 0001 and the ideal $1/2$ LSB value ($1/2$ LSB = 9.8mV for $V_{REF}/2 = 2.500\text{V}$).

Full Scale Adjust

The full scale adjustment can be made by applying a differential input voltage which is $1/2$ LSB down from the desired analog full scale voltage range and then adjusting the magnitude of the $V_{REF}/2$ input (pin 9) for a digital output code which is just changing from 1111 1110 to 1111 1111. When offsetting the zero and using a span-adjusted $V_{REF}/2$ voltage, the full scale adjustment is made by inputting V_{MIN} to the $V_{IN(-)}$ input of the A/D and applying a voltage to the $V_{IN(+)}$ input which is given by:

$$V_{IN(+)} f_{SADJ} = V_{MAX} - 1.5 \left[\frac{(V_{MAX} - V_{MIN})}{256} \right]$$

where:

V_{MAX} = the high end of the analog input range.

and

V_{MIN} = the low end (the offset zero) of the analog range. (Both are ground referenced.)

Clocking Option

The clock for the A/D can be derived from an external source such as the CPU clock or an external RC network can be added to provide self-clocking. The CLK IN (pin 4) makes use of a Schmitt trigger as shown in Figure 16.

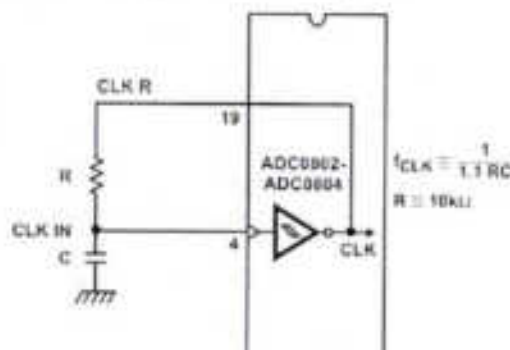

FIGURE 16. SELF-CLOCKING THE A/D

Heavy capacitive or DC loading of the CLK R pin should be avoided as this will disturb normal converter operation. Loads less than 50pF, such as driving up to 7 A/D converter clock inputs from a single CLK R pin of 1 converter, are allowed. For larger clock line loading, a CMOS or low power TTL buffer or PNP input logic should be used to minimize the loading on the CLK R pin (do not use a standard TTL buffer).

Restart During a Conversion

If the A/D is restarted (\overline{CS} and \overline{WR} go low and return high) during a conversion, the converter is reset and a new conversion is started. The output data latch is not updated if the conversion in progress is not completed. The data from the previous conversion remain in this latch.

Continuous Conversions

In this application, the \overline{CS} input is grounded and the \overline{WR} input is tied to the \overline{INTR} output. This \overline{WR} and \overline{INTR} node should be momentarily forced to logic low following a power-up cycle to insure circuit operation. See Figure 17 for details.

Figures 19 and 20 show more sophisticated test circuits.

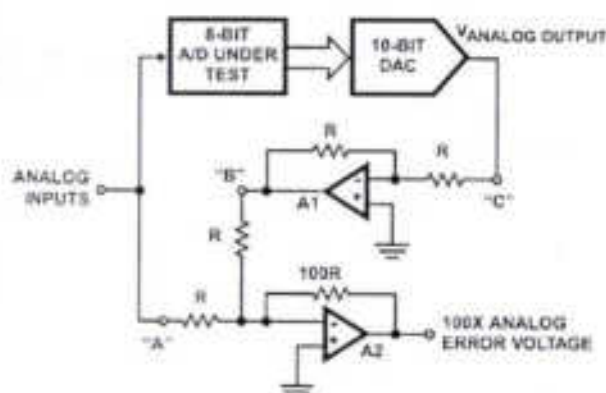

FIGURE 19. A/D TESTER WITH ANALOG ERROR OUTPUT. THIS CIRCUIT CAN BE USED TO GENERATE "ERROR PLOTS" OF FIGURE 11.

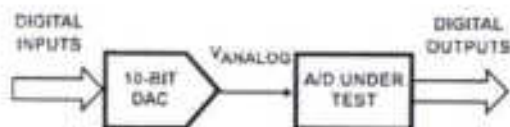

FIGURE 20. BASIC "DIGITAL" A/D TESTER

Typical Applications

Interfacing 8080/85 or Z-80 Microprocessors

This converter has been designed to directly interface with 8080/85 or Z-80 Microprocessors. The three-state output capability of the A/D eliminates the need for a peripheral interface device, although address decoding is still required to generate the appropriate \overline{CS} for the converter. The A/D can be mapped into memory space (using standard memory-address decoding for \overline{CS} and the \overline{MEMR} and \overline{MEMW} strobes) or it can be controlled as an I/O device by using the \overline{IOR} and \overline{IOW} strobes and decoding the address bits A0 → A7 (or address bits A8 → A15, since they will contain the same 8-bit address information) to obtain the \overline{CS} input. Using the I/O space provides 256 additional addresses and may allow a simpler 8-bit address decoder, but the data can only be input to the accumulator. To make use of the additional memory reference instructions, the A/D should be mapped into memory space. See AN020 for more discussion of memory-mapped vs I/O-mapped interfaces. An example of an A/D in I/O space is shown in Figure 21.

The standard control-bus signals of the 8080 (CS, RD and WR) can be directly wired to the digital control inputs of the A/D, since the bus timing requirements, to allow both starting the converter, and outputting the data onto the data bus, are met. A bus driver should be used for larger microprocessor systems where the data bus leaves the PC board and/or must drive capacitive loads larger than 100pF.

It is useful to note that in systems where the A/D converter is 1 of 8 or fewer I/O-mapped devices, no address-decoding circuitry is necessary. Each of the 8 address bits (A0 to A7) can be directly used as \overline{CS} inputs, one for each I/O device.

Interfacing the Z-80 and 8085

The Z-80 and 8085 control buses are slightly different from that of the 8080. General RD and WR strobes are provided and separate memory request, \overline{MREQ} , and I/O request, \overline{IORQ} , signals have to be combined with the generalized strobes to provide the appropriate signals. An advantage of operating the A/D in I/O space with the Z-80 is that the CPU will automatically insert one wait state (the RD and WR strobes are extended one clock period) to allow more time for the I/O devices to respond. Logic to map the A/D in I/O space is shown in Figure 22. By using \overline{MREQ} in place of \overline{IORQ} , a memory-mapped configuration results.

Additional I/O advantages exist as software DMA routines are available and use can be made of the output data transfer which exists on the upper 8 address lines (A8 to A15) during I/O input instructions. For example, MUX channel selection for the A/D can be accomplished with this operating mode.

The 8085 also provides a generalized RD and WR strobe, with an I/O/M line to distinguish I/O and memory requests. The circuit of Figure 22 can again be used, with I/O/M in place of \overline{IORQ} for a memory-mapped interface, and an extra inverter (or the logic equivalent) to provide I/O/M for an I/O-mapped connection.

Interfacing 6800 Microprocessor Derivatives (6502, etc.)

The control bus for the 6800 microprocessor derivatives does not use the RD and WR strobe signals. Instead it employs a single R/W line and additional timing, if needed, can be derived from the $\phi 2$ clock. All I/O devices are memory-mapped in the 6800 system, and a special signal, VMA, indicates that the current address is valid. Figure 23 shows an interface schematic where the A/D is memory-mapped in the 6800 system. For simplicity, the CS decoding is shown using $1/2$ DM8092. Note that in many 6800 systems, an already decoded $4/5$ line is brought out to the common bus at pin 21. This can be tied directly to the CS pin of the A/D, provided that no other devices are addressed at HEX ADDR: 4XXX or 5XXX.

In Figure 24 the ADC0802 series is interfaced to the MC6800 microprocessor through (the arbitrarily chosen) Port B of the MC6820 or MC6821 Peripheral Interface Adapter (PIA). Here the CS pin of the A/D is grounded since the PIA is already memory-mapped in the MC6800 system and no CS decoding is necessary. Also notice that the A/D output data lines are connected to the microprocessor bus under program control through the PIA and therefore the A/D RD pin can be grounded.

Application Notes

NOTE #	DESCRIPTION	AnswerFAX DOC. #
AN016	"Selecting A/D Converters"	9016
AN018	"Do's and Don'ts of Applying A/D Converters"	9018
AN020	"A Cookbook Approach to High Speed Data Acquisition and Microprocessor Interfacing"	9020
AN030	"The ICL7104 - A Binary Output A/D Converter for Microprocessors"	9030

ADC0802, ADC0803, ADC0804

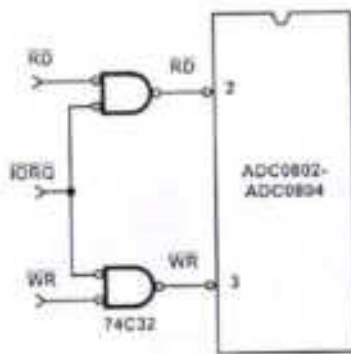
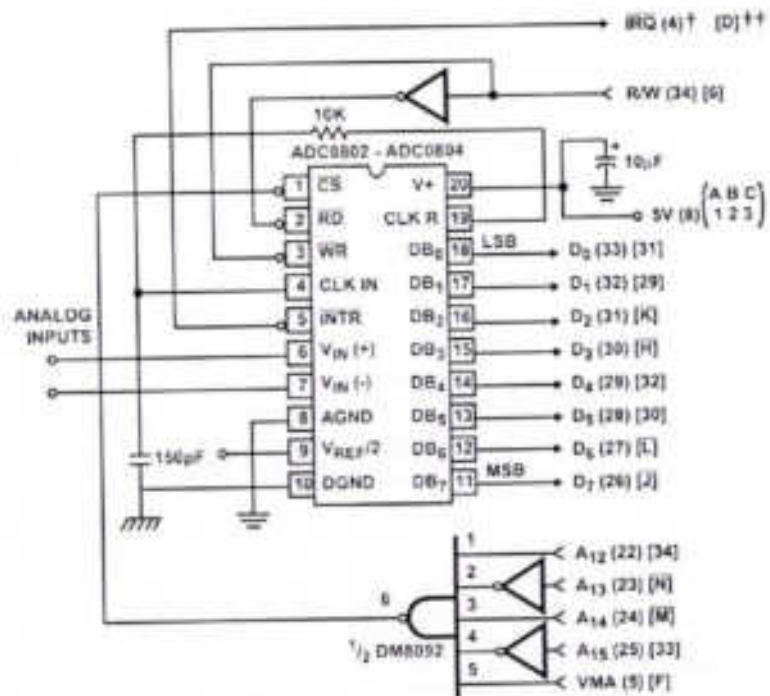

FIGURE 22. MAPPING THE A/D AS AN I/O DEVICE FOR USE WITH THE Z-80 CPU



† Numbers in parentheses refer to MC6800 CPU Pinout.
 †† Numbers or letters in brackets refer to standard MC6800 System Common Bus Code.

FIGURE 23. ADC0802 TO MC6800 CPU INTERFACE

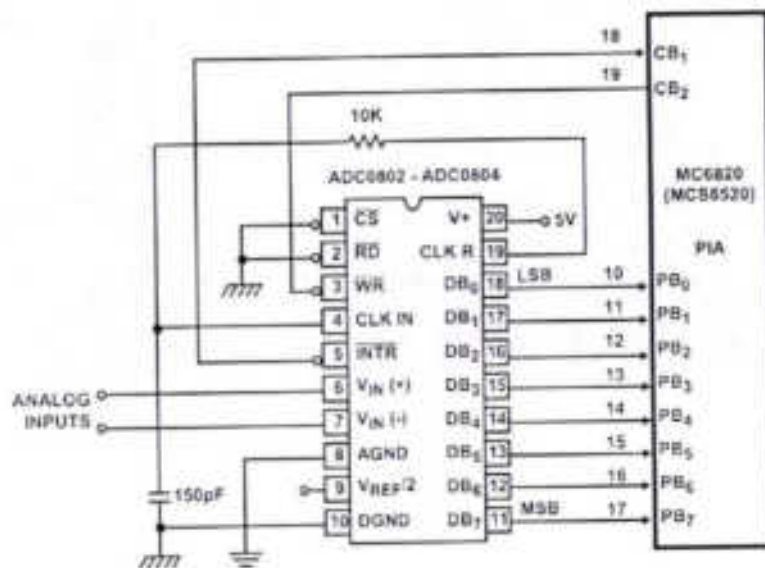

FIGURE 24. ADC0802 TO MC6820 PIA INTERFACE

ADC0802, ADC0803, ADC0804

Die Characteristics

DIE DIMENSIONS:

(101 mils x 93 mils) x 525 μ m x 25 μ m

METALLIZATION:

Type: Al

Thickness: 10k Å \pm 1k Å

PASSIVATION:

Type: Nitride over Silox

Nitride Thickness: 8k Å

Silox Thickness: 7k Å

Metallization Mask Layout

ADC0802, ADC0803, ADC0804

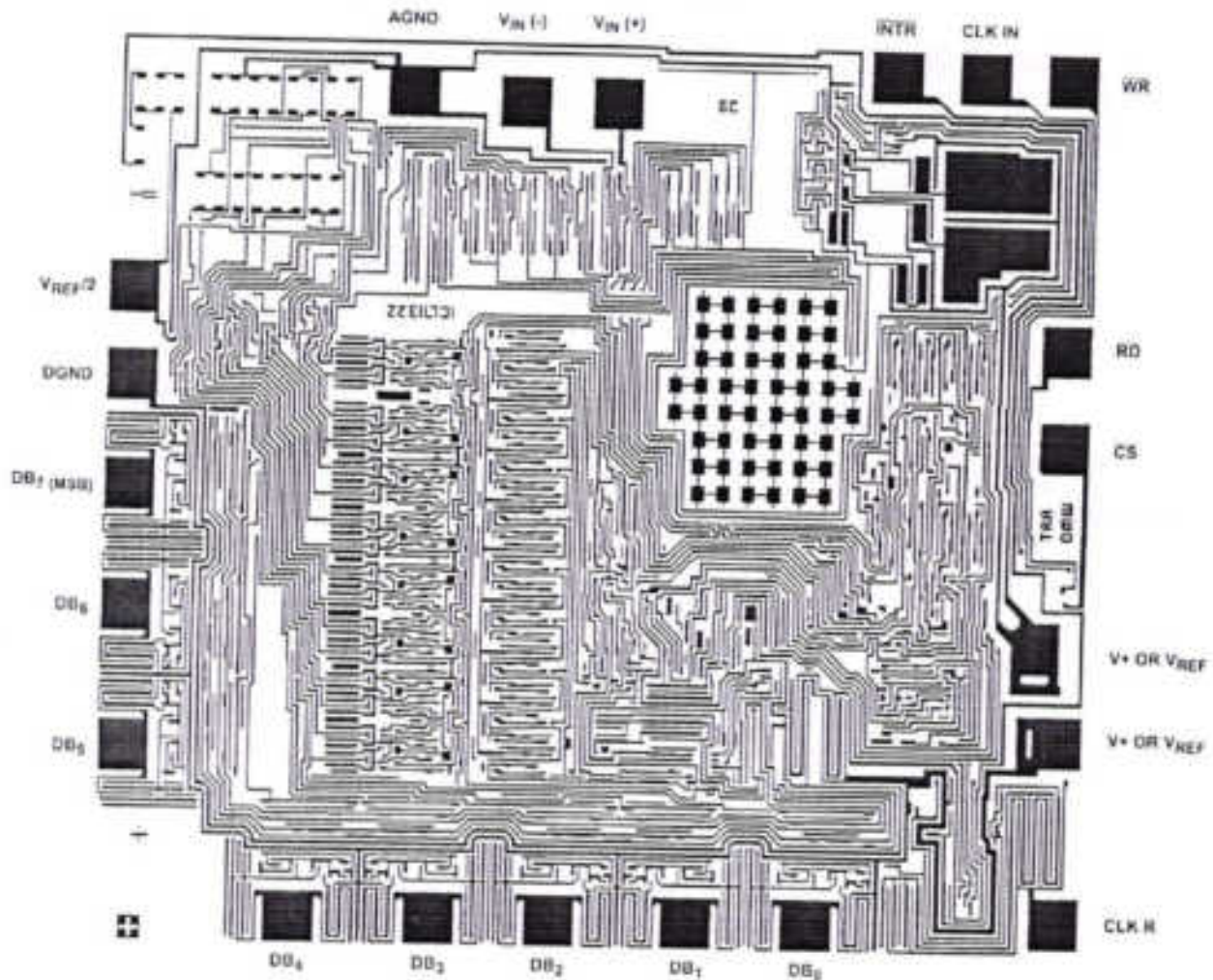

All Intersil semiconductor products are manufactured, assembled and tested under ISO9000 quality systems certification.

Intersil products are sold by description only. Intersil Corporation reserves the right to make changes in circuit design and/or specifications at any time without notice. Accordingly, the reader is cautioned to verify that data sheets are current before placing orders. Information furnished by Intersil is believed to be accurate and reliable. However, no responsibility is assumed by Intersil or its subsidiaries for its use, nor for any infringements of patents or other rights of third parties which may result from its use. No license is granted by implication or otherwise under any patent or patent rights of Intersil or its subsidiaries.

For information regarding Intersil Corporation and its products, see web site: <http://www.intersil.com>

ADC0802, ADC0803, ADC0804

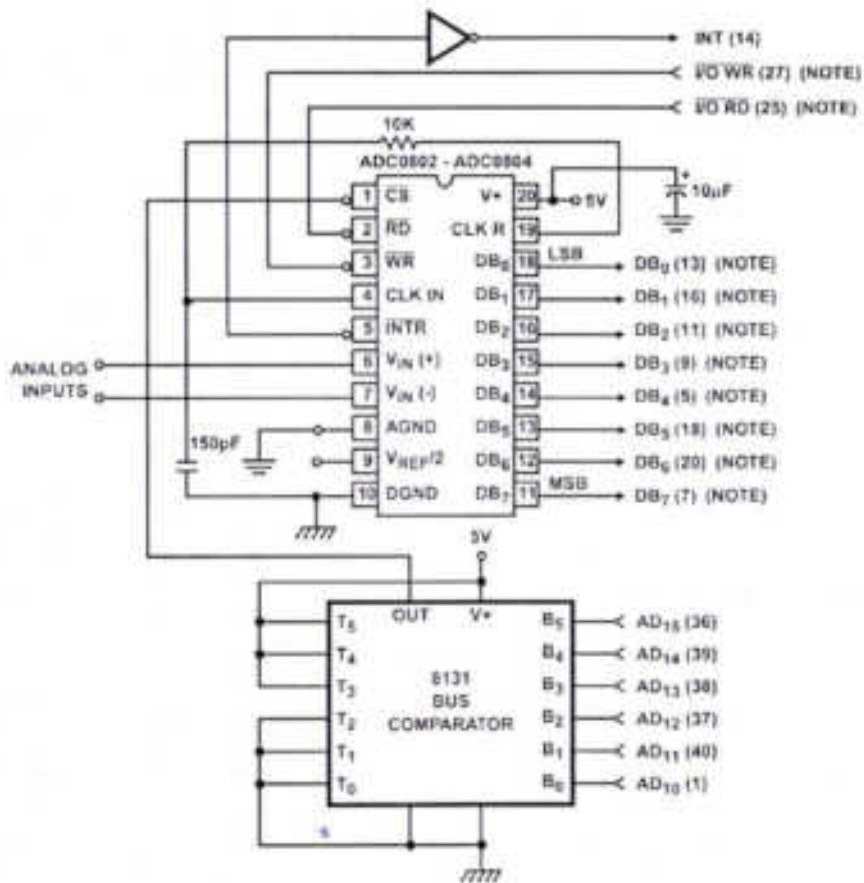

NOTE: Pin numbers for 8228 System Controller; Others are 8080A.

FIGURE 21. ADC0802 TO 8080A CPU INTERFACE

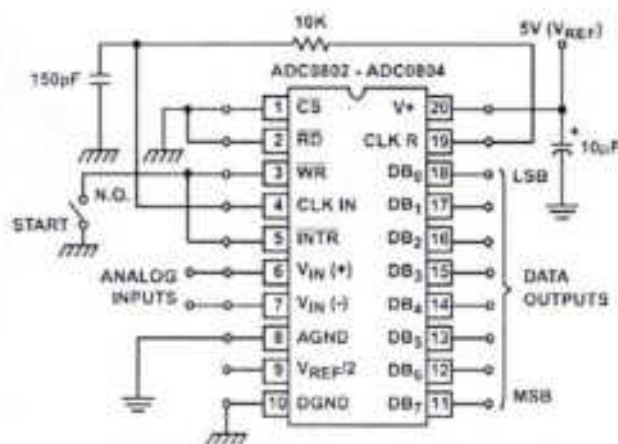

FIGURE 17. FREE-RUNNING CONNECTION

Driving the Data Bus

This CMOS A/D, like MOS microprocessors and memories, will require a bus driver when the total capacitance of the data bus gets large. Other circuitry, which is tied to the data bus, will add to the total capacitive loading, even in three-state (high-impedance mode). Back plane bussing also greatly adds to the stray capacitance of the data bus.

There are some alternatives available to the designer to handle this problem. Basically, the capacitive loading of the data bus slows down the response time, even though DC specifications are still met. For systems operating with a relatively slow CPU clock frequency, more time is available in which to establish proper logic levels on the bus and therefore higher capacitive loads can be driven (see Typical Performance Curves).

At higher CPU clock frequencies time can be extended for I/O reads (and/or writes) by inserting wait states (8080) or using clock-extending circuits (6800).

Finally, if time is short and capacitive loading is high, external bus drivers must be used. These can be three-state buffers (low power Schottky is recommended, such as the 74LS240 series) or special higher-drive-current products which are designed as bus drivers. High-current bipolar bus drivers with PNP inputs are recommended.

Power Supplies

Noise spikes on the V+ supply line can cause conversion errors as the comparator will respond to this noise. A low-inductance tantalum filter capacitor should be used close to the converter V+ pin, and values of 1µF or greater are recommended. If an unregulated voltage is available in the system, a separate 5V voltage regulator for the converter (and other analog circuitry) will greatly reduce digital noise on the V+ supply. An ICL7663 can be used to regulate such a supply from an input as low as 5.2V.

Wiring and Hook-Up Precautions

Standard digital wire-wrap sockets are not satisfactory for breadboarding with this A/D converter. Sockets on PC boards can be used. All logic signal wires and leads should be grouped and kept as far away as possible from the analog

signal leads. Exposed leads to the analog inputs can cause undesired digital noise and hum pickup; therefore, shielded leads may be necessary in many applications.

A single-point analog ground should be used which is separate from the logic ground points. The power supply bypass capacitor and the self-clocking capacitor (if used) should both be returned to digital ground. Any VREF/2 bypass capacitors, analog input filter capacitors, or input signal shielding should be returned to the analog ground point. A test for proper grounding is to measure the zero error of the A/D converter. Zero errors in excess of 1/2 LSB can usually be traced to improper board layout and wiring (see Zero Error for measurement). Further information can be found in Application Note AN018.

Testing the A/D Converter

There are many degrees of complexity associated with testing an A/D converter. One of the simplest tests is to apply a known analog input voltage to the converter and use LEDs to display the resulting digital output code as shown in Figure 18.

For ease of testing, the VREF/2 (pin 9) should be supplied with 2.560V and a V+ supply voltage of 5.12V should be used. This provides an LSB value of 20mV.

If a full scale adjustment is to be made, an analog input voltage of 5.090V (5.120 - 1 1/2 LSB) should be applied to the VIN(+) pin with the VIN(-) pin grounded. The value of the VREF/2 input voltage should be adjusted until the digital output code is just changing from 1111 1110 to 1111 1111. This value of VREF/2 should then be used for all the tests.

The digital-output LED display can be decoded by dividing the 8 bits into 2 hex characters, one with the 4 most-significant bits (MS) and one with the 4 least-significant bits (LS). The output is then interpreted as a sum of fractions times the full scale voltage:

$$V_{OUT} = \left(\frac{MS}{16} + \frac{LS}{256} \right) (5.12) V$$

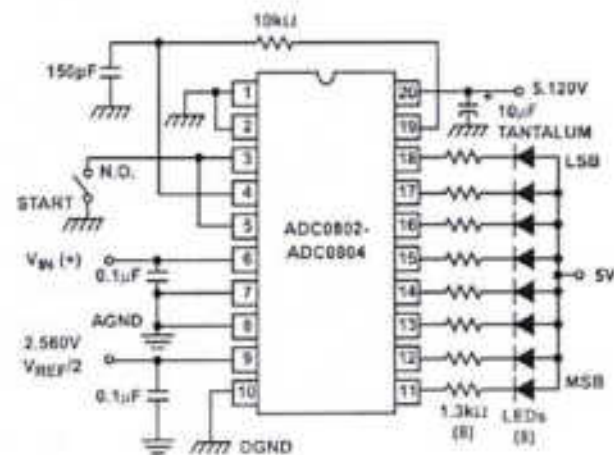

FIGURE 18. BASIC TESTER FOR THE A/D

For example, for an output LED display of 1011 0110, the MS character is hex B (decimal 11) and the LS character is hex (and decimal) 6, so

$$V_{OUT} = \left(\frac{11}{16} + \frac{6}{256} \right) (5.12) = 3.64V$$

Input Source Resistance

Large values of source resistance where an input bypass capacitor is not used will not cause errors since the input currents settle out prior to the comparison time. If a low-pass filter is required in the system, use a low-value series resistor ($\leq 1k\Omega$) for a passive RC section or add an op amp RC active low-pass filter. For low-source-resistance applications ($\leq 1k\Omega$), a $0.1\mu F$ bypass capacitor at the inputs will minimize EMI due to the series lead inductance of a long wire. A 100Ω series resistor can be used to isolate this capacitor (both the R and C are placed outside the feedback loop) from the output of an op amp, if used.

Stray Pickup

The leads to the analog inputs (pins 6 and 7) should be kept as short as possible to minimize stray signal pickup (EMI). Both EMI and undesired digital-clock coupling to these inputs can cause system errors. The source resistance for these inputs should, in general, be kept below $5k\Omega$. Larger values of source resistance can cause undesired signal pickup. Input bypass capacitors, placed from the analog inputs to ground, will eliminate this pickup but can create analog scale errors as these capacitors will average the transient input switching currents of the A/D (see Analog Input Current). This scale error depends on both a large source resistance and the use of an input bypass capacitor. This error can be compensated by a full scale adjustment of the A/D (see Full Scale Adjustment) with the source resistance and input bypass capacitor in place, and the desired conversion rate.

Reference Voltage Span Adjust

For maximum application flexibility, these A/Ds have been designed to accommodate a 5V, 2.5V or an adjusted voltage reference. This has been achieved in the design of the IC as shown in Figure 12.

Notice that the reference voltage for the IC is either $1/2$ of the voltage which is applied to the $V+$ supply pin, or is equal to the voltage which is externally forced at the $V_{REF}/2$ pin. This allows for a pseudo-ratiometric voltage reference using, for the $V+$ supply, a 5V reference voltage. Alternatively, a voltage less than 2.5V can be applied to the $V_{REF}/2$ input. The internal gain to the $V_{REF}/2$ input is 2 to allow this factor of 2 reduction in the reference voltage.

Such an adjusted reference voltage can accommodate a reduced span or dynamic voltage range of the analog input voltage. If the analog input voltage were to range from 0.5V to 3.5V, instead of 0V to 5V, the span would be 3V. With 0.5V applied to the $V_{IN(-)}$ pin to absorb the offset, the reference voltage can be made equal to $1/2$ of the 3V span or 1.5V. The A/D now will encode the $V_{IN(+)}$ signal from 0.5V to 3.5V with the 0.5V input corresponding to zero and the 3.5V input corresponding to full scale. The full 8 bits of resolution are therefore applied over this reduced analog input voltage range. The requisite connections are shown in Figure 13. For expanded scale inputs, the circuits of Figures 14 and 15 can be used.

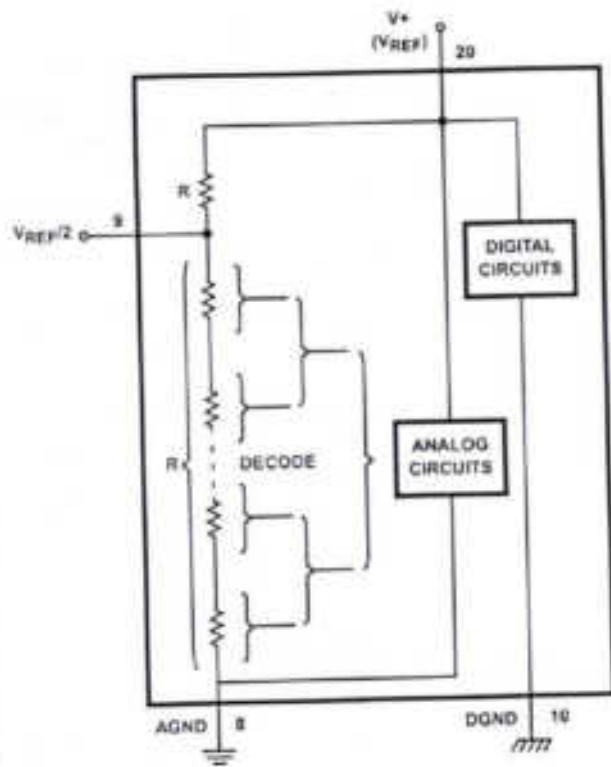

FIGURE 12. THE $V_{REFERENCE}$ DESIGN ON THE IC

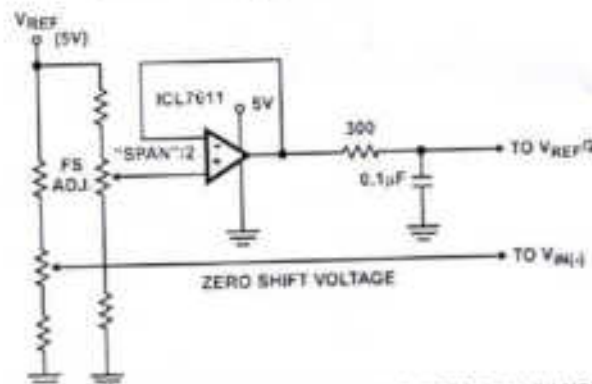

FIGURE 13. OFFSETTING THE ZERO OF THE ADC0802 AND PERFORMING AN INPUT RANGE (SPAN) ADJUSTMENT

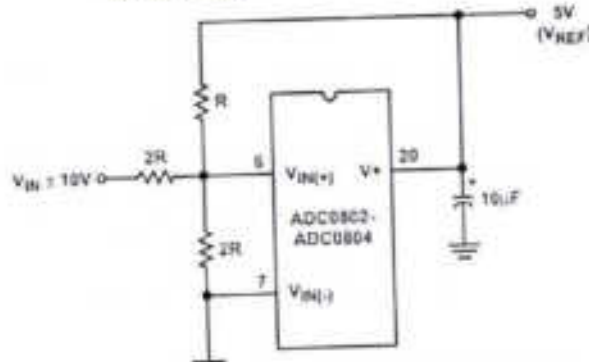

FIGURE 14. HANDLING $\pm 10V$ ANALOG INPUT RANGE

FIGURE 11A. ACCURACY = ± 0.5 LSB; PERFECT A/DFIGURE 11B. ACCURACY = $\pm 1/2$ LSB

FIGURE 11. CLARIFYING THE ERROR SPECS OF AN A/D CONVERTER

Understanding A/D Error Specs

A perfect A/D transfer characteristic (staircase wave-form) is shown in Figure 11A. The horizontal scale is analog input voltage and the particular points labeled are in steps of 1 LSB (19.53mV with 2.5V tied to the $V_{REF}/2$ pin). The digital output codes which correspond to these inputs are shown as D-1, D, and D+1. For the perfect A/D, not only will center-value (A-1, A, A+1, ...) analog inputs produce the correct output digital codes, but also each riser (the transitions between adjacent output codes) will be located $\pm 1/2$ LSB away from each center-value. As shown, the risers are ideal and have no width. Correct digital output codes will be provided for a range of analog input voltages which extend $\pm 1/2$ LSB from the ideal center-values. Each tread (the range of analog input voltage which provides the same digital output code) is therefore 1 LSB wide.

The error curve of Figure 11B shows the worst case transfer function for the ADC0802. Here the specification guarantees that if we apply an analog input equal to the LSB analog voltage center-value, the A/D will produce the correct digital code.

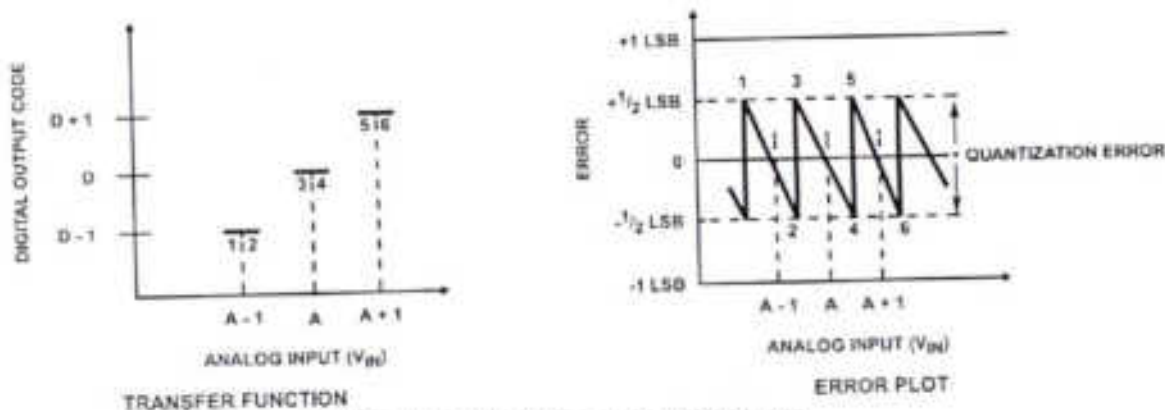
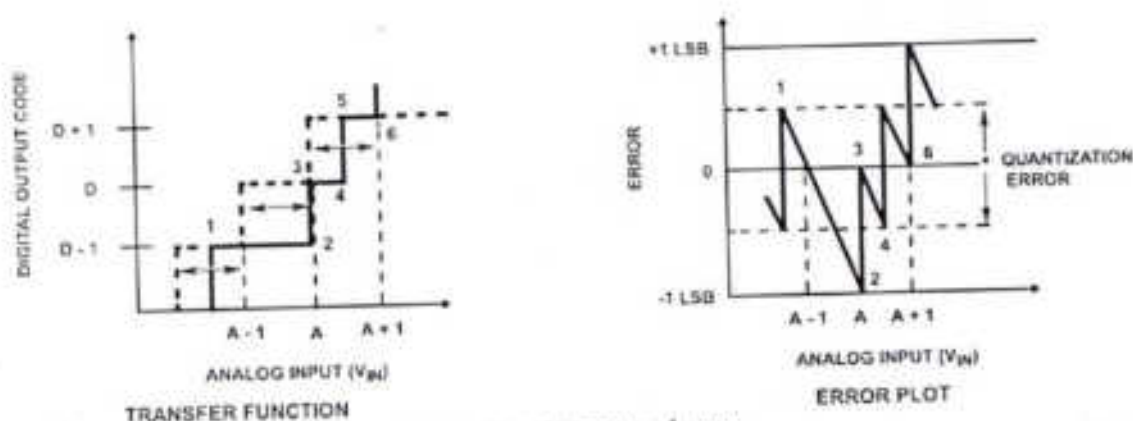
Next to each transfer function is shown the corresponding error plot. Notice that the error includes the quantization uncertainty of the A/D. For example, the error at point 1 of Figure 11A is $+1/2$ LSB because the digital code appeared $1/2$ LSB in advance of the center-value of the tread. The error plots always have a

constant negative slope and the abrupt upside steps are always 1 LSB in magnitude, unless the device has missing codes.

Detailed Description

The functional diagram of the ADC0802 series of A/D converters operates on the successive approximation principle (see Application Notes AN016 and AN020 for a more detailed description of this principle). Analog switches are closed sequentially by successive-approximation logic until the analog differential input voltage [$V_{IN(+)} - V_{IN(-)}$] matches a voltage derived from a tapped resistor string across the reference voltage. The most significant bit is tested first and after 8 comparisons (64 clock cycles), an 8-bit binary code (1111 1111 = full scale) is transferred to an output latch.

The normal operation proceeds as follows. On the high-to-low transition of the WR input, the internal SAR latches and the shift-register stages are reset, and the INTR output will be set high. As long as the CS input and WR input remain low, the A/D will remain in a reset state. Conversion will start from 1 to 8 clock periods after at least one of these inputs makes a low-to-high transition. After the requisite number of clock pulses to complete the conversion, the INTR pin will make a high-to-low transition. This can be used to interrupt a processor, or otherwise signal the availability of a new conversion. A RD operation (with CS low) will clear the INTR line high again.

Typical Performance Curves

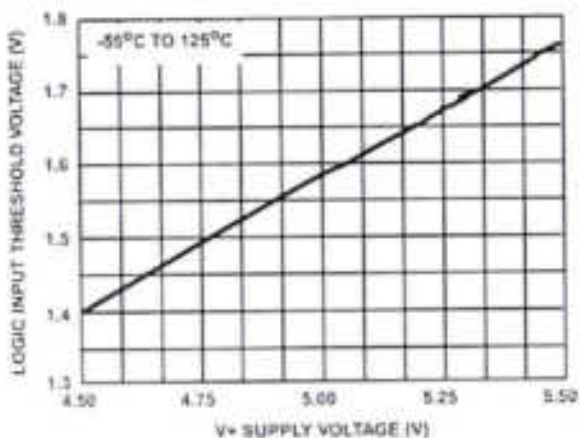

FIGURE 2. LOGIC INPUT THRESHOLD VOLTAGE vs SUPPLY VOLTAGE

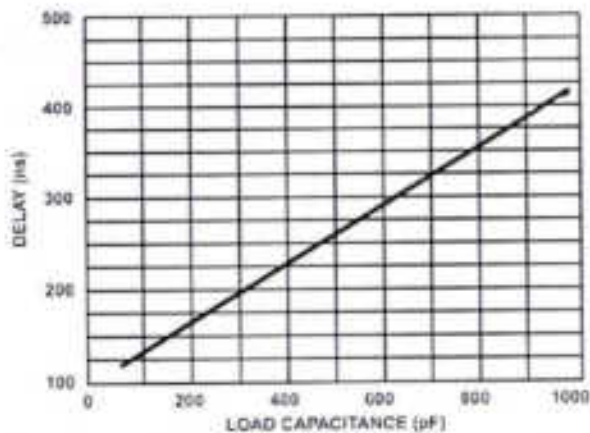

FIGURE 3. DELAY FROM FALLING EDGE OF RD TO OUTPUT DATA VALID vs LOAD CAPACITANCE

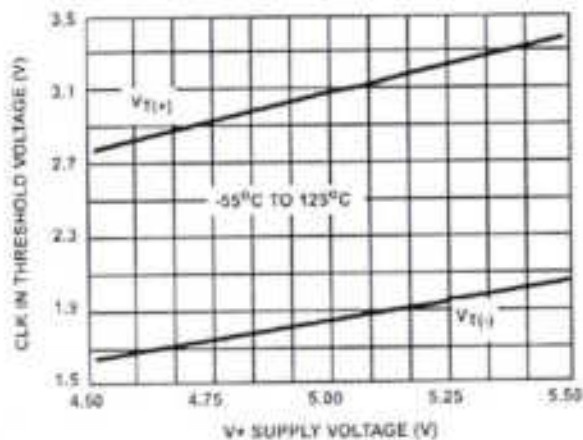

FIGURE 4. CLK IN SCHMITT TRIP LEVELS vs SUPPLY VOLTAGE

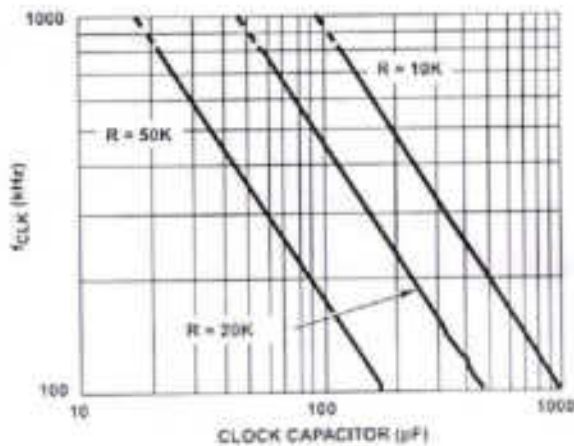

FIGURE 5. f_{CLK} vs CLOCK CAPACITOR

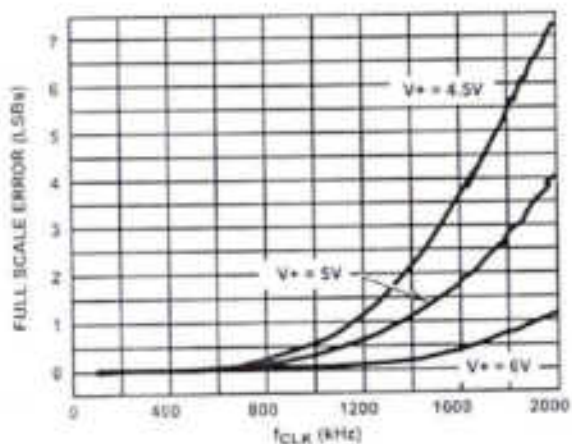

FIGURE 6. FULL SCALE ERROR vs f_{CLK}

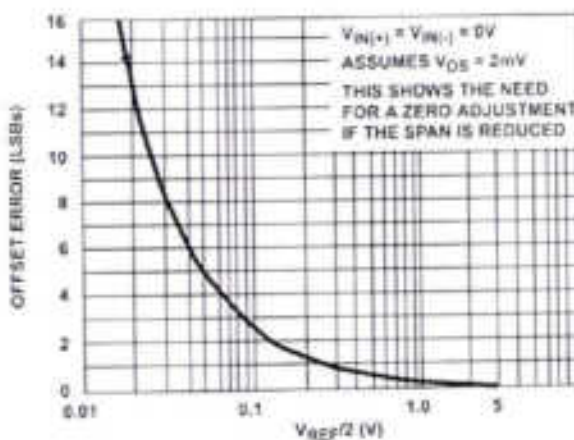

FIGURE 7. EFFECT OF UNADJUSTED OFFSET ERROR

ADC0802, ADC0803, ADC0804

Absolute Maximum Ratings

Supply Voltage	6.5V
Voltage at Any Input	-0.3V to (V ⁺ + 0.3V)

Operating Conditions

Temperature Range	
ADC0802/03LD	-55°C to 125°C
ADC0802/03/04LCD	-40°C to 85°C
ADC0802/03/04LCN	0°C to 70°C
ADC0803/04LCVM	-40°C to 85°C

Thermal Information

Thermal Resistance (Typical, Note 1)	θ_{JA} (°C/W)	θ_{JC} (°C/W)
PDIP Package	125	N/A
CERDIP Package	80	20
SOIC Package	120	N/A
Maximum Junction Temperature		
Hermetic Package		175°C
Plastic Package		150°C
Maximum Storage Temperature Range		-65°C to 150°C
Maximum Lead Temperature (Soldering, 10s)		300°C (SOIC - Lead Tips Only)

CAUTION: Stresses above those listed in "Absolute Maximum Ratings" may cause permanent damage to the device. This is a stress only rating and operation of the device at these or any other conditions above those indicated in the operational sections of this specification is not implied.

NOTE:

- θ_{JA} is measured with the component mounted on an evaluation PC board in free air.

Electrical Specifications (Notes 1, 7)

PARAMETER	TEST CONDITIONS	MIN	TYP	MAX	UNITS
CONVERTER SPECIFICATIONS V ⁺ = 5V, T _A = 25°C and f _{CLK} = 640kHz, Unless Otherwise Specified					
Total Unadjusted Error					
ADC0802	V _{REF/2} = 2.500V	-	-	± ¹ / ₂	LSB
ADC0803	V _{REF/2} Adjusted for Correct Full Scale Reading	-	-	± ¹ / ₂	LSB
ADC0804	V _{REF/2} = 2.500V	-	-	±1	LSB
V _{REF/2} Input Resistance	Input Resistance at Pin 9	1.0	1.3	-	kΩ
Analog Input Voltage Range	(Note 2)	GND-0.05	-	(V ⁺) + 0.05	V
DC Common-Mode Rejection	Over Analog Input Voltage Range	-	± ¹ / ₁₆	± ¹ / ₈	LSB
Power Supply Sensitivity	V ⁺ = 5V ±10% Over Allowed Input Voltage Range	-	± ¹ / ₁₆	± ¹ / ₈	LSB
CONVERTER SPECIFICATIONS V ⁺ = 5V, 0°C to 70°C and f _{CLK} = 640kHz, Unless Otherwise Specified					
Total Unadjusted Error					
ADC0802	V _{REF/2} = 2.500V	-	-	± ¹ / ₂	LSB
ADC0803	V _{REF/2} Adjusted for Correct Full Scale Reading	-	-	± ¹ / ₂	LSB
ADC0804	V _{REF/2} = 2.500V	-	-	±1	LSB
V _{REF/2} Input Resistance	Input Resistance at Pin 9	1.0	1.3	-	kΩ
Analog Input Voltage Range	(Note 2)	GND-0.05	-	(V ⁺) + 0.05	V
DC Common-Mode Rejection	Over Analog Input Voltage Range	-	± ¹ / ₈	± ¹ / ₄	LSB
Power Supply Sensitivity	V ⁺ = 5V ±10% Over Allowed Input Voltage Range	-	± ¹ / ₁₆	± ¹ / ₈	LSB
CONVERTER SPECIFICATIONS V ⁺ = 5V, -25°C to 85°C and f _{CLK} = 640kHz, Unless Otherwise Specified					
Total Unadjusted Error					
ADC0802	V _{REF/2} = 2.500V	-	-	± ³ / ₄	LSB
ADC0803	V _{REF/2} Adjusted for Correct Full Scale Reading	-	-	± ³ / ₄	LSB
ADC0804	V _{REF/2} = 2.500V	-	-	±1	LSB
V _{REF/2} Input Resistance	Input Resistance at Pin 9	1.0	1.3	-	kΩ
Analog Input Voltage Range	(Note 2)	GND-0.05	-	(V ⁺) + 0.05	V
DC Common-Mode Rejection	Over Analog Input Voltage Range	-	± ¹ / ₈	± ¹ / ₈	LSB
Power Supply Sensitivity	V ⁺ = 5V ±10% Over Allowed Input Voltage Range	-	± ¹ / ₁₆	± ¹ / ₈	LSB

Functional Diagram

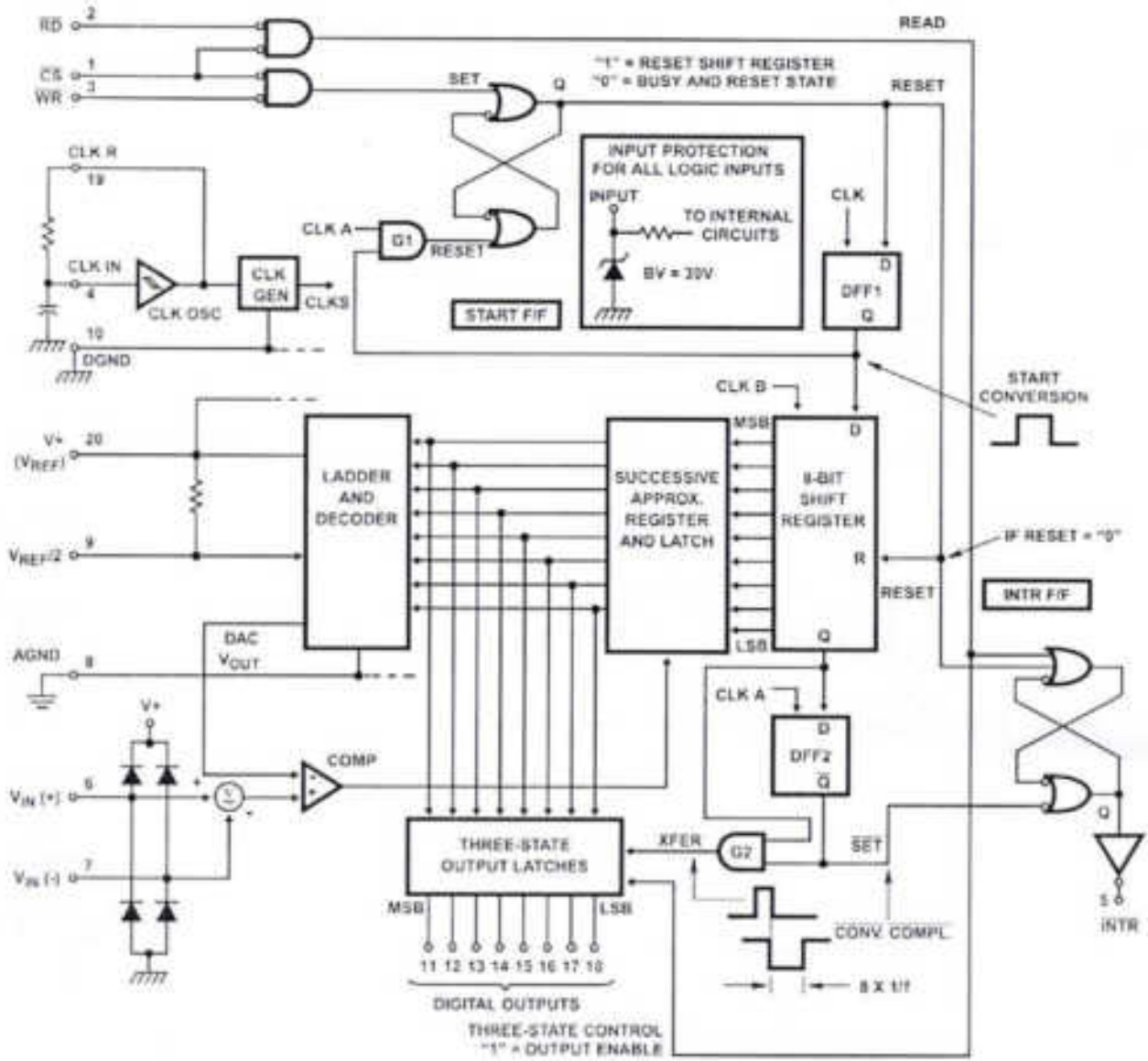



DHARAMPETH M. P. DEO MEMORIAL SCIENCE COLLEGE, NAGPUR

INTERNAL QUALITY ASSURANCE CELL (IQAC)

Activity Report

Date: 14th February 2023

Name of Organizing Department or Committee : Electronics Department

Name of the Activity : Crosswords in C language

Suggested CRITERION point if any : Suggested criteria II

Date of Activity : 14th February 2023

Place of Activity : Electronics Lab

Name of Guest Speaker/s or Judge/s or Chief Guest/s if any : Not applicable

Title of the Activity: Crosswords in C language

Based on Unit : 1(Paper I)

Class : Semester VI

Number of Participants : 18

Name of the Teacher In-charge / Convener: Mrs. Leena P. Thakare

OUTCOME of the Activity with respect to mission vision of the institute and or academics:

Students learn different types of keywords creatively.

Prof. Pitambar Humane

COORDINATOR

INTERNAL QUALITY ASSURANCE CELL
DHARAMPETH, M. P. DEO MEMORIAL &
SCIENCE COLLEGE, NAGPUR.

Prof. Varsha V. Rangari
Dr. Varsha V. Rangari
Head of the Department
Department of Electronics
Dharampeth M.P. Deo Memorial
Science College, Nagpur

Dr. Akhilesh Peshwe

Principal
Dharampeth M.P. Deo Memorial
Science College, Nagpur.



DHARAMPETH M. P. DEO MEMORIAL SCIENCE COLLEGE, NAGPUR

Department of Electronics

Semester VI- (2022-23)

Assignment 1 (Paper I- Unit- I)

Sr. No.	Student Name	Mobile Number	Email Id
1	Tanmay Sunil Gadam	7262034396	tanmaygadaml@gmail.com
2	Bhavesh Rameshwar Maske	7489951631	bhaveshmaske2002@gmail.com
3	Aarti Brijkishor Singh	7709208740	aartibsingh222@gmail.com
4	Rani Devidas Kokate	7998945148	ranikokate1009@gmail.com
5	Riddhi Abhay Rajkarne	8669809201	riddhirajkarne@gmail.com
6	Pratham Manbahadur Sonar	7558464862	manbhaisonar@gmail.com
7	Rajat Laxman Rohad	9175635273	
8	Mukund Sanjay Hood	9604785822	mukundahood2003@gmail.com
9	Kiran Ramesh Waghade	9860218676	rameshwaghade20@gmail.com
10	Megha Tribhuwan Bisen	9637770341	bisenmegha320@gmail.com
11	Sakshi Sanjay Huddar	9405142450	huddarmahi@gmail.com
12	Ankita Laxman Sonwane	9284801790	ankitasonwane10@gmail.com
13	Soniya Bhashamber Chaniya	7028563411	rvchaniya@gmail.com
14	Samiksha Vasant Tabhane	9307133863	samikshavtabhane@gmail.com
15	Sakshi Satish Hiwarkar	9356651344	Sakshihiwarkar1831@gmail.com
16	Mahesh Prabhakarrao Maske	9021951173	maheshmaske48@gmail.com
17	Pranay Santosh Mahajan	9158377419	pranaymahajan413@gmail.com
18	Kartik Kamal Parasad Tiwari	9156498206	tiwarikartik292@gmail.com

Name & Signature of Teacher In-Charge

Pitambar Humane

[Signature]

Prof. Pitambar Humane
IQAC Coordinator

CO ORDINATOR

INTERNAL QUALITY ASSURANCE CELL
DHARAMPETH, M. P. DEO MEMORIAL &
SCIENCE COLLEGE, NAGPUR

Name & Signature of Head of the Department

Dr. Varsha V. Rannari

Dr. Varsha V. Rannari

Professor & Head

Department of Electronics

Dharampeth M.P. Deo Memorial

Science College, Nagpur

Dr. Akhilesh Peshwe

Principal

Principal

Dharampeth M.P. Deo Memorial
Science College, Nagpur.



DHARAMPETH M. P. DEO MEMORIAL SCIENCE COLLEGE, NAGPUR

INTERNAL QUALITY ASSURANCE CELL (IQAC)

Activity Report

Date: 14-02-2023

Name of Organizing Department or Committee: Department of Statistics.

Name of the activity: Gamma with one parameter and gamma with two parameters.
Suggested CRITERION point if any:

Date of Activity: 14 feb 2023

Place of Activity: Statistics lab

Name of Guest Speaker/s or Judge/s or Chief Guest/s if any:

Title of the Activity: Gamma with one parameter and gamma with two parameters.

Number of Participants: 22

Name of the Teacher: Durga hingwe

Names of other Committee Members / Staff: N.A.

OUTCOME of the Activity with respect to mission vision of the institute and or academics:

Gamma two parameter are both strictly positive, because one is the number of events and the other is the rate of events. Its importance is largely due to its relation to exponential and normal distribution.

Activity with newspaper coverage if any: No

Activity data save in PC of: Department of Statistics

Prof. Pitambar Humane
IQAC Coordinator

CO ORDINATOR

INTERNAL QUALITY ASSURANCE CELL
DHARAMPETH, M. P. DEO MEMORIAL &
SCIENCE COLLEGE, NAGPUR

Name & Signature of Teacher In-charge

Dr. Akhilesh Peshwe
Principal

Dharampeth M.P. Deo Memorial
Science College, Nagpur.



DHARAMPETH M. P. DEO MEMORIAL SCIENCE COLLEGE NAGPUR

Department of Statistics

Class: B.Sc. Sem.- II

NEP ACTIVITY

Paper-I

Unit-IV

Name of the Teacher: Durga C. Hingwe

Date: 14-02-23

Title of Activity: Gamma with one parameter and gamma with two parameters.

Sr. No.	Name of Student	Batch	Mobile No.	Email ID	Signature
1)	Megha S. Ballav	FSM(F1)	9421728880	meghaballav04@gmail.com	<u>MBallav</u>
2)	Veena Borikar	SCOM	9322016921	veenaborikar14@gmail.com	<u>Veena</u>
3)	Janki Kisanpore	SCOM	7058235243	jankikisanpore@gmail.com	<u>Kisanpore</u>
4)	Sonia Niwal	SCOM	7058425021	niwalsonia70@gmail.com	<u>soniawal</u>
5)	Rutika Yadav	F2 Som	8446085943	yadavrutika494@gmail.com	<u>Ryadar</u>
6)	Varsha Turkar	F2 som	8373650950	varshaturkar468@gmail.com	<u>Varsha</u>
7)	Nisha Kosarkar	F2	9890996645	nishakosarkar333@gmail.com	<u>ntz</u>
8)	Mohit Khurdkar	Scom	805525557	mohitkhurdkar@gmail.com	<u>Mohitkar</u>
9)	Jagruuti Fulkawar	SCOM	8767911307	jagruitifulkawar@gmail.com	<u>Jagruuti</u>
10)	Pranali V. Gupta	SCOM	7020069377	28991537@gmail.com	<u>Gupta</u>
11)	Divyani V. Zagde	SCOM	902286318	divyanizagde@gmail.com	<u>DZagde</u>
12)	Janvi Khode	SCOM	7385066634	Janvi khode392@gmail.com	<u>JKhode</u>
13)	Janki Joge	F2	7385060871	jankijoge08@gmail.com	<u>Janki</u>
14)	Shikha Deshpande	F2	9130091540	shikha-deshpande216@gmail.com	<u>Shikha</u>
15)	Devashai Kalkde	F2 som	9021344265	kalkdevashai@gmail.com	<u>D.Kalkde</u>
16)	Pradnya Tipude	F2	9010562232	pradnyatipude914@gmail.com	<u>Pradnya</u>
17)	Utkarsh Ingale	F2.	7499159178	Utkarsharingale4@gmail.com	<u>Utkarsh</u>
18)	Sakshi Mishra	F2	9529889915	smishra39683@gmail.com	<u>Sakshi</u>
19)	Janvi Laibor	F2	8446510539	janvilaibor@gmail.com	<u>Janvi</u>
20)	Vidya Lohi	F2	7020963219	vidyalohi3@gmail.com	<u>Vidya</u>
21)	Pranali Sehankar	F2	8767581278	pdonha@gmail.com	<u>Pranali</u>
22)	Nayan Walthare	F1	794182747	NayanWalthare4@gmail.com	<u>NayanWalthare</u>

Durga C. Hingwe
Signature of Teacher

Durga C. Hingwe
Teacher incharge



DHARAMPETH M. P. DEO MEMORIAL SCIENCE COLLEGE, NAGPUR

INTERNAL QUALITY ASSURANCE CELL (IQAC)

Activity Report

Date: 14/02/2023

Name of Organizing Department or Committee: Department of Mathematics

Name of the activity: NEP based Short note on the work of Mathematician

(Bolzano / Weierstrass) for B.Sc. Semester-IV

Suggested CRITERION point if any: Criterion I.

Date of Activity: 14/02/2023

Place of Activity: Class room

Name of Guest Speaker/s or Judge/s or Chief Guest/s if any: NA

Title of the Activity: Short note on the work of Mathematician (Bolzano / Weierstrass)

Activity with newspaper coverage if any: No

Number of Participants: B.Sc. Semester-IV Students (31)

Name of the Teacher In-charge / Convener: Dr. N. P. Gaikwad

Names of other Committee Members / Staff: Mr. Roshan Thakre

OUTCOME of the Activity with respect to academics:

The outcome of the activity is to easy to find the contribution of work of Mathematician (Bolzano/Weierstrass). There are different important equilibrium concepts in economics, the proofs of the existence of which often require variations of the Bolzano–Weierstrass theorem.

DVV: Enclosed.

Prof. Pitambar Humane

IQAC Coordinator

IQAC Co-ordinator

Dharampeth M.P. Deo Memorial
Science College, Nagpur-440033

Name & Signature of Teacher In-charge

Dr. Akhilesh Peshwe

Principal

PRINCIPAL

Dharampeth M.P. Deo Memorial
Science College, Nagpur-440033



DHARAMPETH M. P. DEO MEMORIAL SCIENCE COLLEGE,
North Ambazari Road, Near Ambazari Lake, Nagpur- 440033

DATA VALIDATION & VERIFICATION (DVV)

Name of the Programme : NEP based Short note on the work
Date of the Programme : 14/02/2023 of Mathematician (Bolzano/
Name of Chief Guest if any : Wierstrass) for
Name of Guest Speaker if any : B-S C Semester - IV

Sr. No.	Name of the Participant	Mobile Number	E-mail Id	Signature
(1)	Ashmit Juwan	9080235161	ashmitjuwan@gmail.com	Ashmit Juwan
(2)	Atharav Umate	92561641511	atharavumate@gmail.com	Atharav Umate
(3)	Ayaz Shukle	8767355503	ayaz25908@gmail.com	Ayaz Shukle
(4)	Ayush R. Basilkar	9579445092	ayushbasilkar45@gmail.com	Ayush Basilkar
(5)	Chetan V. Bopche	9172484628	Chetanbopche27@gmail.com	Chetan Bopche
(6)	Dungesh K. Singh	7385310432	Singha1242@gmail.com	Dungesh Singh
(7)	Dungesh T. Rokde	9730561301	Rokde dungesh1@gmail.com	Dungesh Rokde
(8)	Gaurav P. Londge	7767854082	GauravLondge@gmail.com	Gaurav Londge
(9)	Hemant V. Dote	8530970186	hemantdote@gmail.com	Hemant Dote
(10)	Hitesh G. Kaware	7058427112	hiteshkaware77@gmail.com	Hitesh Kaware

Signature of:

Programme In-charge

IQAC Coordinator

IQAC Co-ordinator
Dharampeth M.P. Deo Memorial
Science College, Nagpur-440033

Principal
PRINCIPAL

Dharampeth M.P. Deo Memorial
Science College, Nagpur-440033



DHARAMPETH M. P. DEO MEMORIAL SCIENCE COLLEGE,
North Ambazari Road, Near Ambazari Lake, Nagpur- 440033

DATA VALIDATION & VERIFICATION (DVV)

11)	Maitik. C. Mishra	9067445755	Kumar Maitik Mishra 1010@gmail.com	<u>Maitik</u>
12)	Komal. S. Patle	9881798506	Komalpatle234@gmail.com	<u>Patle</u>
13)	Rohit S. Wanjari	7741061907	wrohit091@~	<u>Rohit</u>
14)	Shashank Pandey	9998624684	pandeyshashank502@gmail.com	<u>Shashank</u>
15)	Sujit. S. FUSEY	9370192756	sujitfusey@gmail.com	<u>Sujit Fusey</u>
16)	Vatan S Sonwane	9975410765	NandanSonwane@gmail.com	<u>Vatan</u>
17)	Waxudeo K. Lakumapur	9146134509	waxudeo.lakumapur 11@gmail.com	<u>Waxudeo</u>
18)	Yamini A. Mishra	8623040663	Yamini.mishra2259 @gmail.com	<u>Yamini</u>
19)	YASH. R. DHOYAR	9689792728	Yashbhojra2212@gmail.com	<u>Yash</u>
20	Aditya Kumar Singh	7350548901	adityaSingh280180@gmail.com	<u>A.K.S</u>
21	Nitin 'A' Kulkarni	9693429005	nitinkulkarni706@gmail.com	<u>Nitin</u>
22	Nupur Sharma	9322042259	nupursharma258@gmail.com	<u>Nupur</u>
23	Adityakumar Shukla	9518994638	adityashukla0025@gmail.com	<u>Shukla</u>
24	Jay Anilbhai Patil	7385436956	jay.patil0326@gmail.com	<u>Jay</u>
25	Anuj H. Mishra	8103656208	anujmishra251202@gmail.com	<u>Anuj Mf.</u>
26	Kavita Mishra	9657199201	Km752859@gmail.com	<u>Km</u>

Signature of:

Programme In-charge

IQAC Coordinator
IQAC Co-ordinator

Dharampeth M.P. Deo Memorial
Science College, Nagpur-440033

Principal
PRINCIPAL

Dharampeth M.P. Deo Memorial
Science College, Nagpur-440033



DHARAMPETH M. P. DEO MEMORIAL SCIENCE COLLEGE, NAGPUR
INTERNAL QUALITY ASSURANCE CELL (IQAC)

Activity Report

Date: 15/2/2023

Name of Organizing Department or Committee: Chemistry

Name of the activity: B. Sem - VI, Paper I, Unit- I (Metal Ligand Bonding in Transition Metal Complexes)

Suggested CRITERION point if any: Criteria I, II

Date of Activity: 14/2/2023

Place of Activity: Class room of College

Name of Guest Speaker/s or Judge/s or Chief Guest/s if any: Nil

Title of the Activity: Application of CFT in Chemistry

Number of Participants: 56

Name of the Teacher In-charge / Convener: Dr. Vaishali P. Meshram

Names of other Committee Members / Staff: Dr Deepika Brijpuria , Ms. Avanti Bhusari, Ms Niharika Sute

OUTCOME of the Activity with respect to mission vision of the institute and or academics:

1. It helps us to explain the formation of low spin and high spin complexes. Strong field ligands split d-orbital up to large extent.
2. Therefore pairing of electrons takes place and the complex is low spin.
- (3) It also explains the colour of the complexes.

Activity with newspaper coverage if any: Nil

Activity data save in PC of: Chemistry

Note: Kindly share geotag photographs separately along with report on iqacdisc2022@gmail.com

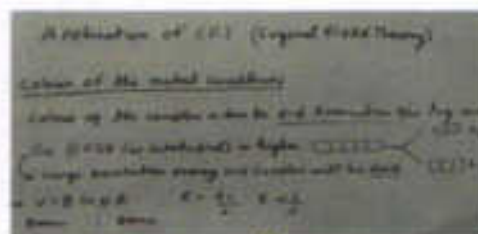

Prof. Pitambar Humane
IQAC Coordinator

Dr. Vaishali P. Meshram
Name & Signature of Teacher In-charge

Dr. Akhilesh Peshwe
Principal

CO ORDINATOR
INTERNAL QUALITY ASSURANCE CELL
DHARAMPETH, M. P. DEO MEMORIAL &
SCIENCE COLLEGE, NAGPUR

PRINCIPAL
Dharampeth M.P. Deo Memorial
Science College, Nagpur-440033



DHARAMPETH M. P. DEO MEMORIAL SCIENCE COLLEGE,
North Ambazari Road, Near Ambazari Lake, Nagpur- 440033

DATA VALIDATION & VERIFICATION (DVV)

Name of the Programme : Application of CFT in Chemistry
Date of the Programme : 14/02/2023
Name of Chief Guest if any : —
Name of Guest Speaker if any : —

Sr. No.	Name of the Participant	Mobile Number	E-mail Id	Signature
1	Manish S. Gode	9370329857	manishgode79@gmail.com	<u>Mcode</u>
2	Vanshika C. Yede	7558246609	vanshikayede@gmail.com	<u>Vyede</u>
3	Tanmay Bhute	7697250831	tanmaybhute900@gmail.com	<u>Tan</u>
4	Neha R. Khawase	8766758340	neha2002kkr@gmail.com	<u>NKhawase</u>
5	Kaetik Adlakha	8530597159	kadlakha@gmail.com	<u>Adlakha</u>
6	Chetan Kamthe	9637271601	kautilhachetan@gmail.com	<u>Chetan</u>
7	Anjali R. Mishra	8319948106	am38654@gmail.com	<u>Anjali</u>
8	Bechi K Vardhe	9825336932	BechiVardhe@gmail.com	<u>Vardhe</u>
9	Anjali N. Charde	8261964188	anjalicarde20@gmail.com	<u>ACharde</u>
10	Damini M. Bardsbuche	8275105785	bardsbuchedamini@gmail.com	<u>D. Bardsbuche</u>

Signature of:

Pr. Meshram

Programme In-charge

Pr. Vaishali P. Meshram

Signature of:

Pr. Meshram

IQAC COORDINATOR
INTERNAL QUALITY ASSURANCE CELL
DHARAMPETH M. P. DEO MEMORIAL &
SCIENCE COLLEGE, NAGPUR

Pr. Meshram

Principal
PRINCIPAL

Dharampeth M.P. Deo Memorial
Science College, Nagpur-440033



DHARAMPETH M. P. DEO MEMORIAL SCIENCE COLLEGE,
North Ambazari Road, Near Ambazari Lake, Nagpur-440033

DATA VALIDATION & VERIFICATION (DVV)

11	TEJAL A. Mankar	9322458697	tejal.mankar933@gmail.com TEJAL
12	Priyanka L. Gujwar	9579263881	priyankagujwar2000@gmail.com Priyanka
13	Amisha R. Anje	8767618394	amv1016@gmail.com Amisha
14	Jayashree D. Hiwark	7385473157	Juhithiawar10@gmail.com J.D. Hiwark
15	Amit J. Walde	9168496253	amitwalde4uodiya@gmail.com Amit
16	Akansha S. Bhute	9356964121	akansha20206@gmail.com ABhute
17	Nitin L. Harinkhede	9561179324	harinkhede.vijay@gmail.com Nitin
18	Sakshi V. Chamate	9709204933	chamate.sakshizu@gmail.com Sakshi
19	Asha S. Landge	9322231581	ashalandge2000@gmail.com Asha S. Landge
20	Suraj Shende	9356666487	Surajshende2018@gmail.com Suraj
21	Megha Fulwar	8605399606	meghafulwar@gmail.com Megha
22	Prathom Shankumar Gupta	8767275449	Prathomgupta16@gmail.com Prathom
23	Apita T. Dakhale	8010866758	apitadakhale02@gmail.com Dakhale
24	Meunali R. Songare	9850163812	Songaremeunali16@gmail.com Meunali
25	Anshuman Sharmar	9370892462	anshuman.sharma.2014@gmail.com Anshuman
26	Vishal Kumar Singh	9610187223	SinghVishal9602@gmail.com Vishal

Signature of:

Programme In-charge

IQAC Coordinator

CO ORDINATOR

INTERNAL QUALITY ASSURANCE CELL
DHARAMPETH, M. P. DEO MEMORIAL &
SCIENCE COLLEGE, NAGPUR

Principal

PRINCIPAL

Dharampeth M.P. Deo Memorial
Science College, Nagpur-440033



DHARAMPETH M. P. DEO MEMORIAL SCIENCE COLLEGE,
North Ambazari Road, Near Ambazari Lake, Nagpur- 440033

DATA VALIDATION & VERIFICATION (DVV)

27	Supriya Patle	7757871925	patlesupriya@gmail.com	Patle
28	Sonam Upgrade	9890230462	upgradesonam@gmail.com	Suprade
29	Sushila Patil	7507439390	Sushilapatil2007@gmail.com	spatil
30	Lahmi G. Sayam	7517793675	Sayamlahmi@gmail.com	Lahyam
31	Rakhi. P. Gedam	7378312504	gedamrakhi2007@gmail.com	Rpgedam
32	Dolly B Gubhane	9284269236	dollygubhane7@gmail.com	Dgubhane
33	Neha. A. Waghade	7249895144	nehawaghade16052002@gmail.com	NWaghade
34	Kaustubh. R. Ramteke	7218487719	ramtekekaustubh2007@gmail.com	KRramteke
35	Arushi. S. Wele	8530778433	arushiwel@gmail.com	Arushi
36	Aryali. R. Pali	7498102109	aryalipali@gmail.com	Aryali
37	Pall. N. Patnan	8669895188	Rasthnan6604@gmail.com	Patnan
38	Anushka. S. Das	7058933157	ad04092001@gmail.com	Das
39	Rani D. Patel	7888241794	ranipatel6521@gmail.com	Rani
40	Akanksha R. Yelug	8767935524	akankshayelug@gmail.com	Akanksha
41	Pallavi Y. Bhagat	9022654940	Pallaviy2208@gmail.com	Bhagat
42	Raksha D. Dhole	7498511875	ratshadhole3@gmail.com	R.Dhote

Signature of:

Programme In-charge

IQAC Coordinator

CO-ORDINATOR
INTERNAL QUALITY ASSURANCE CELL
DHARAMPETH M. P. DEO MEMORIAL &
SCIENCE COLLEGE, NAGPUR

Principal
PRINCIPAL

Dharampeth M.P. Deo Memorial
Science College, Nagpur-440033



DHARAMPETH M. P. DEO MEMORIAL SCIENCE COLLEGE,
North Ambazari Road, Near Ambazari Lake, Nagpur- 440033

DATA VALIDATION & VERIFICATION (DVV)

43	Chaitali M. Burbade	9359540394	chaitali2020b@gmail.com	Chaitali
44	Priyanshi Singh	7219259020	priyanshisingh804@gmail.com	Singh
45	Nandini P. Pournika	9764359642	nandini.pournika@gmail.com	Nandini
46	Sakshi Moon	7745827736	sakshimoon30@gmail.com	Sakshi Moon
47	Shivani G. Bhude	9302500209	shiveshivani82@gmail.com	Bhude
48	Manali S. Shinde	7249637434	mandalishinde062@gmail.com	Shinde
49	Karishma S. Bansod	738982507	karishmabansod401@gmail.com	Karishma
50	Shruti M. Pawar	9521988707	shrutipawar0001@gmail.com	Pawar
51	Aishwarya A. Joshi	7491328662	aishwaryajoshi2008@gmail.com	Joshi
52	Ishika S. Thakre	8010907069	ishithakre022@gmail.com	Thakre
53	Lakmi M. Gauri	7758058514	laxmigaure2908@gmail.com	Gauri
54	Nandini S. Hadge	9370301679	nandinihadger@gmail.com	Hadge
55	Bhargavi A. Sambare	7709403806	bhargavisambare00@gmail.com	Sambare
56	Tanmay S. Choudhari	8600102341	tchoudhari8600@gmail.com	Choudhari
57				
58				

Signature of:

Programme In-charge

IQAC Coordinator
CO ORDINATOR
INTERNAL QUALITY ASSURANCE CELL
DHARAMPETH, M. P. DEO MEMORIAL &
SCIENCE COLLEGE, NAGPUR

Principal
PRINCIPAL
Dharampeth M.P. Deo Memorial
Science College, Nagpur-440033



DHARAMPETH M.P. DEO MEMORIAL SCIENCE COLLEGE, NAGPUR
INTERNAL QUALITY ASSURANCE CELL (IQAC)

Activity Report

Date: 15th Feb. 2023

Name of Organizing Department or Committee: Home Science

Name of the activity: Collection of different Rural Developmental news articles and prepare album.

Suggested CRITERION point if any:

Date of Activity: 15th Feb. 2023

Place of Activity: Home Science Department

Name of Guest Speaker/s or Judge/s or Chief Guest/s if any: NA

Title of the Activity:

Preparation of Rural Developmental Album

Number of Participants: 12

Name of the Teacher In-charge/Convener: Dr. Ashwini Meshram

Name of other Committee Members/Staff: Mrs. Rekha and Mrs. Vaishali

OUTCOME of the Activity with respect to mission/vision of the institute and/or academics:

- 1) Create the habit of reading newspaper among students.
- 2) Becomes aware about the development activities are going around.
- 3) Carefully read the content and then collect related development articles.

Activity with newspaper coverage if any: NA

Activity data save in PC of:

Prof. Pitambar Humane
IQAC Coordinator

CO ORDINATOR
INTERNAL QUALITY ASSURANCE CELL
DHARAMPETH, M. P. DEO MEMORIAL &
SCIENCE COLLEGE, NAGPUR

Dr. Ashwini Meshram
Name & Signature of Teacher In-charge

Dr. Akhilesh Peshwe
Principal

Dharampeth M.P. Deo Memorial
Science College, Nagpur-440033



DHARAMPETH M. P. DEO MEMORIAL SCIENCE COLLEGE,
North Ambazari Road, Near Ambazari Lake, Nagpur- 440033

DATA VALIDATION & VERIFICATION (DVV)

Name of the Programme : Collection of different Rural Developmental news articles and prepare rural album
Date of the Programme : 15th Feb. 2023
Name of Chief Guest if any : -
Name of Guest Speaker if any : -

Sr. No.	Name of the Participant	Mobile Number	E-mail Id	Signature
1.	Prema J. Chaudhari	7620384149	chaudhariprema294@gmail.com	P. Chaudhari
2.	Anshikha U. Jaisankar	9021391207	anshikhajaisankar@gmail.com	Anshikha
3.	Shalu P. Pawdhi	8329115380	shalupawdhi3@gmail.com	Shalu
4.	SAKSHA R. CHAKONDE	7847018801	Sakshichakonde@gmail.com	S. Chakonde
5.	Aditi R. Vaidya	9075714531	aditivaidya619@gmail.com	Aditi
6.	Hemlata Verma	7744958020	vermahemlata951@gmail.com	Hemlata
7.	shubhangi Nishad	9923455073	shubhanishad2510@gmail.com	Nishad
8.	Minal Patle	9158070732	patleminal83@gmail.com	Minal
9.	Bharana Jeyudasan	8888437303	bharana.jeyudasan@gmail.com	Bharana
10.	Anchal Kulkarni	9309560449	anchal.kulkarni@gmail.com	Anchal

Signature of:

Programme In-charge

COORDINATOR
INTERNAL QUALITY ASSURANCE CELL
DHARAMPETH, M. P. DEO MEMORIAL &
SCIENCE COLLEGE, NAGPUR

PRINCIPAL
Dharampeth M.P. Deo Memorial
Science College, Nagpur-440033



DHARAMPETH M. P. DEO MEMORIAL SCIENCE COLLEGE, NAGPUR
INTERNAL QUALITY ASSURANCE CELL (IQAC)

Activity Report

Date: 16.02.2023

Name of Organizing Department or Committee: Dept. of Home Science

Name of the activity: Discussion on impact of agricultural practices on mineral content of food. (NEP 2022 Activity)

Suggested CRITERION point if any:

Date of Activity: 16.02.2023

Place of Activity: Classroom, Dept. of Home Science

Name of Guest Speaker/s or Judge/s or Chief Guest/s if any:

Title of the Activity: Discussion on impact of agricultural practices on mineral content of food

Number of Participants: 09

Name of the Teacher In-charge / Convener: Mrs. Meghna Pandit

Names of other Committee Members / Staff:

OUTCOME of the Activity with respect to mission vision of the institute and or academics:

To develop practical understanding of impact of agricultural practices on mineral content and nutritional quality of food.

Activity with newspaper coverage if any:

Activity data save in PC of: _____

Note: Kindly share geotag photographs separately along with report on jqacdsc2022@gmail.com

Date of the _____

Prof. Pitambar Humane

IQAC Coordinator

COORDINATOR
INTERNAL QUALITY ASSURANCE CELL
DHARAMPETH, M. P. DEO MEMORIAL &
SCIENCE COLLEGE, NAGPUR

Name & Signature of Teacher In-charge
(Mrs. Meghna Pandit)

Dr. Akhilesh Peshwe

Principal

Dharampeth M. P. Deo Memorial
Science College, Nagpur-440033





DHARAMPETH M. P. DEO MEMORIAL SCIENCE COLLEGE,
North Ambazari Road, Near Ambazari Lake, Nagpur- 440033

DATA VALIDATION & VERIFICATION (DVV)

Name of the Programme : Discussion on impact of agricultural practices on mineral content of food.
Date of the Programme : 16.02.2023
Name of Chief Guest if any : -
Name of Guest Speaker if any : -

Sr. No.	Name of the Participant	Mobile Number	E-mail Id	Signature
1)	Shalu L. Patil	8829115380	shalupatil1@gmail.com	
2)	Neha R. Vishwakarma	8988524143	nehavishwakarma8528@gmail.com	
3.	Minal L. Patle	7350730164	fulleminal83@gmail.com	
4.	Aditi R. Vaidya	9075714591	aditivaidya619@gmail.com	
5	SAKSHI R. CHAKUNDE	7843018801	sakshichakunde@gmail.com	
6.	Prerna J. Chaudhari	7620384149	chaudhampreerna29@gmail.com	
7.	Anshikha U. Jaiswarakar	9021391207	anshikhajaiswarakar@gmail.com	
8.	Gayatri N. Varma	9763287531	gayatrisarma06@gmail.com	
9.	Bhavana Gusudasani	8888437303	bhavanagusudasani@gmail.com	

Signature of:

Programme In-charge
(Mrs. Megha Pandit)

IQA COORDINATOR
INTERNAL QUALITY ASSURANCE CELL
DHARAMPETH, M. P. DEO MEMORIAL &
SCIENCE COLLEGE, NAGPUR

Dharampeth M. P. Deo Memorial
Science College, Nagpur-440033



DHARAMPETH M. P. DEO MEMORIAL SCIENCE COLLEGE, NAGPUR

INTERNAL QUALITY ASSURANCE CELL (IQAC)

Activity Report

Date: 16/02/2023

Name of Organizing Department or Committee: Department of Mathematics

Name of the activity: NEP based Compare Gradient, Divergence and curl for B.Sc. Semester-II

Suggested CRITERION point if any: Criterion I.

Date of Activity: 16/02/2023

Place of Activity: Class room

Name of Guest Speaker/s or Judge/s or Chief Guest/s if any: NA

Title of the Activity: Compare Gradient, Divergence and curl Activity with newspaper coverage if any: No

Number of Participants: B.Sc. Semester-II Students (49)

Name of the Teacher In-charge / Convener: Dr. N. P. Gaikwad

Names of other Committee Members / Staff: Mr. Roshan Thakre

OUTCOME of the Activity with respect to academics:

The outcome of the activity is to easy to find Gradient, Divergence and curl. We can say that the gradient operation turns a scalar field into a vector field. Note that the result of the divergence is a scalar function. We can say that the divergence operation turns a vector field into a scalar field. Note that the result of the curl is a vector field.

DVV: Enclosed.

Name & Signature of Teacher In-charge

Prof. Pitambar Humane
IQAC Coordinator

IQAC Co-ordinator
Dharampeth M.P. Deo Memorial
Science College, Nagpur-440033

Dr. Akhlesh Peshwe
Principal
PRINCIPAL

Dharampeth M.P. Deo Memorial
Science College, Nagpur-440033



DHARAMPETH M. P. DEO MEMORIAL SCIENCE COLLEGE,
North Ambazari Road, Near Ambazari Lake, Nagpur- 440033

DATA VALIDATION & VERIFICATION (DVV)

Name of the Programme : NEP based Compare gradient,
Date of the Programme : 16/02/2023 | Divergence, and curl for
Name of Chief Guest if any : B.Sc Semester - II
Name of Guest Speaker if any :

Sr. No.	Name of the Participant	Mobile Number	E-mail Id	Signature
1.	Simran Dhimala	7666330683	simrandhimala80@gmail.com	Dhimala
2.	Akhishak Singh	8208948107	akhishak2005@gmail.com	Singh
3.	Vedant O. Umekar	9049932753	umekarvedant@gmail.com	Umekar
4.	Preetiksha J. Borse	9599836818	Preetikshaborse49@gmail.com	Borse
5.	Tanuja . J. Yelwe	9529447565	tanujayelwe72@gmail.com	J. Yelwe
6.	Pranali V. Gupta	7020069377	23991537@gmail.com	Gupta
7.	Badal G. Somkumar	7448247750	badalsomkumar1@gmail.com	Somkumar
8.	Tejus R Chelmalwar	360662119	tejuschelmalwar@gmail.com	Chelmalwar
9.	Isha I. Waghmare	8855919474	ishawaghmare2474@gmail.com	Waghmare
10.	Mounali D. Philkar	9322727616	mounaliphilkar@gmail.com	Philkar

Signature of

Programme In-charge

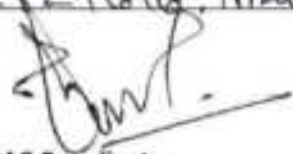
IQAC Co-ordinator
Dharampeth M. P. Deo Memorial
Science College, Nagpur-440033

Principal
PRINCIPAL
Dharampeth M. P. Deo Memorial
Science College, Nagpur-440033



DHARAMPETH M. P. DEO MEMORIAL SCIENCE COLLEGE,
North Ambazari Road, Near Ambazari Lake, Nagpur- 440033

DATA VALIDATION & VERIFICATION (DVV)

11)	Bhagyashali D. Newase	7796434177	Sakshinewase2017@gmail.com B.D. Newase
12)	Mahima Khare	9545918678	mahimakhare@gmail.com Mahima
13)	Janvi Khode	8985066684	Janvikhode1972@gmail.com Janvi
14)	Divyani Zagade	9022866318	divyani.zagade@gmail.com Divyani Zagade
15)	Samiksha	9763095890	sanikshapondichandhe@gmail.com Sami
16)	Varsha Turkar	9373650980	varshaturkar485@gmail.com Varsha
17)	Rutika Yadav	8446085943	yadavrutika934@gmail.com Rutika
18)	Janhui Jage	7385060871	Janhuijage.08@gmail.com Janhui
	Priyanshu Singh	9527710380	Priyanshu Singh1001@gmail.com Priyanshu
	Vibhanshu Terno	9561232204	Vibhanshu terni 7@gmail.com Vibhanshu
21)	Fejas Dongre	9322578918	9322578918@gmail.com Fejas
	Janvi Laibex	8446510539	Janvilaibex@gmail.com Janvi
22)	Tannu A. Vasthi	9322044903	tannuvasthi@gmail.com Tannu
23)	Sakshi Mishra	9529889315	smishra39683@gmail.com Sakshi
24)	Mohit Khadkar	8055328357	mohitkhadkar@gmail.com Mohit
25)	Nikhil Kale	9529113941	nikhilkale1803@gmail.com Nikhil Kale

Signature of:

Programme In-charge

IQAC Coordinator

IQAC Co-ordinator
Dharampeth M.P. Deo Memorial
Science College, Nagpur-440033

Principal
PRINCIPAL

Dharampeth M.P. Deo Memorial
Science College, Nagpur-440033



DHARAMPETH M. P. DEO MEMORIAL SCIENCE COLLEGE,
North Ambazari Road, Near Ambazari Lake, Nagpur-440033

DATA VALIDATION & VERIFICATION (DVV)

26)	Gordal B. Maachade	9112142728	nikhilmaachade2005@gmail.com	Maachade
27)	Uday C. Baghel	8459545609	bagheluday@gmail.com	Baghel
	Punit B. Bawaikar	9707219301	AniketBawaikar@gmail.com	Bawaikar
29)	Suraj M. Mishra	9730639023	surajmishra@gmail.com	Mishra
30)	Trushabh Saha	8057300294	trushabh.saha2004@gmail.com	Saha
31)	Janhvi Kismapure	7058235243	janhvikismapure@gmail.com	Kismapure
32)	Utkarsha Ingale	7413153178	utkarshaingale9@gmail.com	Ingale
34)	Pradhya Tisipude	010362232	Pradhyatispude3145@gmail.com	Tisipude
35)	Chetna Buihle	8010342968	buihlechetna@gmail.com	Buihle
36)	Shruutika G. Pise	9322316336	shruutikapise679@gmail.com	Pise
37)	Divyani G Zade	7972403069	divyanizade2005@gmail.com	Zade
38)	Vaidehi Nagalkar	9325963446	vaidehinagalkar07@gmail.com	Nagalkar
39)	Samiksha Chendre	7420881158	samikshachendre08@gmail.com	Chendre
40)	Suraj Dabhy	7620170190	surajdabhy144@gmail.com	Dabhy
41)	Manu. P. Patil	7350450579	manupatil.7350450@gmail.com	Patil
42)	Nayal N. Walthare	7841876947	nayalwalthare122@gmail.com	Walthare

Signature of:

Programme In-charge

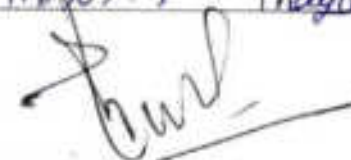

IQAC Coordinator

IQAC Co-ordinator

Dharampeth M.P. Deo Memorial
Science College, Nagpur-440033



Principal

PRINCIPAL

Dharampeth M.P. Deo Memorial
Science College, Nagpur-440033



DHARAMPETH M. P. DEO MEMORIAL SCIENCE COLLEGE, NAGPUR
INTERNAL QUALITY ASSURANCE CELL (IQAC)

NEP Activity Report

Date: 16/02/2023

Name of Organizing Department or Committee: Chemistry Department

Name of the activity: NEP Activity Report (Sem- II Unit-II)

Suggested CRITERION point if any: Criteria II

Date of Activity: 16/02/2023

Place of Activity: Corridor of Chemistry Department

Name of Guest Speaker/s or Judge/s or Chief Guest/s if any: Nil

Title of the Activity: Identification of Optical activity of different compound

Number of Participants: 43

Name of the Teacher In-charge / Convener: Dr. Pranita Gawande

Names of other Committee Members / Staff: Dr. Vaishali Meshram

OUTCOME of the Activity with respect to mission vision of the institute and or academics:

Optical activity is one of the important concepts of Stereochemistry. The spatial arrangement of the atoms in space gives different confirmations and configuration to a molecule. This activity make student to learn the concept of Optical activity in different molecules.

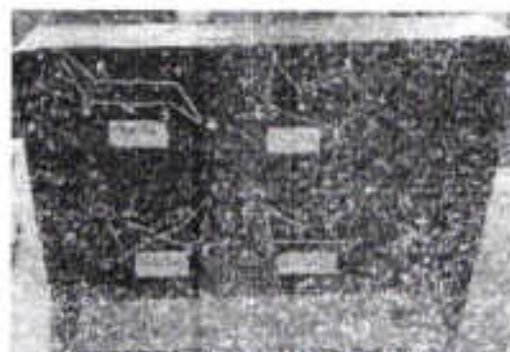

Activity with newspaper coverage if any: Nil

Activity data save in PC of: Chemistry Department

Note: Kindly share geotag photographs separately along with report on iqacds2022@gmail.com

Prof. Pitambar Humane
IQAC Coordinator

CO ORDINATOR
INTERNAL QUALITY ASSURANCE CELL
DHARAMPETH, M. P. DEO MEMORIAL &
SCIENCE COLLEGE, NAGPUR

Pwg (Dr. P. V. Gawande)
Name & Signature of Teacher In-charge

Dr. Arhifesh Peshwe
Principal
DHARAMPETH M. P. DEO MEMORIAL
Science College, Nagpur-440033



DHARAMPETH M. P. DEO MEMORIAL SCIENCE COLLEGE,
North Ambazari Road, Near Ambazari Lake, Nagpur- 440033

DATA VALIDATION & VERIFICATION (DVV)

Name of the Programme : NEP Activity - Identification of Optical activity of different compound
Date of the Programme : 16-02-23 (Sem II, Paper I, Unit II)
Name of Chief Guest if any :
Name of Guest Speaker if any :

Sr. No.	Name of the Participant	Mobile Number	E-mail Id	Signature
1)	Monika J. Patel	7499225468	monikapatel11038@gmail.com	[Signature]
2)	Shital O. Patle	9764596337	spg23@gmail.com	[Signature]
3)	Yogita K. Thakre	7841024445	yogitathakre2586@gmail.com	[Signature]
4)	Karishma N. Prasad	9309318667	harendraprasad72@gmail.com	Karishma
5)	Shreya G. Bhinte	9687762811	shreyabhinte1@gmail.com	Shreya
6)	Shruti K. Pise	9322316336	shrutikapise67@gmail.com	[Signature]
7)	Sonali G. Chaudhary	8856055003	sonalichaudhary12@gmail.com	[Signature]
8)	Ritika R. Sandhiya	9175581655	ritikasandhiya@gmail.com	Ritika
9)	Kastir M. Deshmukh	9649720460	kastikarnal20@gmail.com	[Signature]
10)	Urmang G. Wairathi	9322428500	urmanguwarthi@gmail.com	[Signature]

Signature of:

[Signature]
Programme In-charge

[Signature]
IQAC Coordinator

CO ORDINATOR
INTERNAL QUALITY ASSURANCE CELL
DHARAMPETH, M. P. DEO MEMORIAL &
SCIENCE COLLEGE, NAGPUR

[Signature]
Principal
PRINCIPAL

Dharampeth M. P. Deo Memorial
Science College, Nagpur-440033



DHARAMPETH M. P. DEO MEMORIAL SCIENCE COLLEGE,
North Ambazari Road, Near Ambazari Lake, Nagpur- 440033

DATA VALIDATION & VERIFICATION (DVV)

11)	Vaidehi. P. Thote	7558499191	vaidetikthote27@gmail.com V.P.Thote
12)	Ashwini R. Chaudhary	9699792732	chaudharyashwini287@gmail.com A.R.Chaudhary
13)	Vaishali M. Sahare	9972925403	Vaishali Sahare 251@gmail.com Vaishali
14)	Khineshwar R. Pashptode	8624976072	khineshwaripashptode@gmail.com Kh
15)	Ankit R. Patel	9970905638	ankitpatel797275@gmail.com A.Patel
16)	Saurabh S. Chaudhary	9359883501	schaudhary5599@gmail.com S.Chaudhary
17)	Pratibha B. Bhusari	7821048413	pbbhusari718@gmail.com P.B.B.
18)	Shivam U. Patel	7038889083	SP040263@gmail.com Shivam
19)	Durgesh K. Ghodmare	9075318618	durgeshghodmare01@gmail.com Durgesh
20)	Ritika R. Bhojar	9834587087	ritikabhoyar28@gmail.com Ritika
21)	Ruchi P. Dwivedi	8080776893	RitikaBhojar230@gmail.com R.Dwivedi
22)	Anjali R. Thakre	7066554821	thakreanjur31@gmail.com Anjali
23)	Komalika Chaudhari	9322033866	KomalikaChaudhari@gmail.com Komalika
24)	Apeksha Kotarqale	7559455794	ApekshaKotarqale28@gmail.com Apeksha
25)	Lucky A Vishwakarma	9579660186	lvishwakarma40@gmail.com Lucky
26)	Nity B. Rai	7058630704	ranity1419@gmail.com Nity

Signature of:

Programme In-charge

IQAC Coordinator

CO ORDINATOR
INTERNAL QUALITY ASSURANCE CELL
DHARAMPETH M. P. DEO MEMORIAL &
SCIENCE COLLEGE, NAGPUR

Principal

PRINCIPAL
Dharampeth M. P. Deo Memorial
Science College, Nagpur-440033



DHARAMPETH M. P. DEO MEMORIAL SCIENCE COLLEGE,
North Ambazari Road, Near Ambazari Lake, Nagpur- 440033

DATA VALIDATION & VERIFICATION (DVV)

27)	Abhay P. Tembhare	8975363141	abhay230102@gmail.com	<i>Abhay</i>
28)	Nisha Pandey	8605231290	abhishek.8605231290@gmail.com	<i>Nisha</i>
29)	Aparna Mohare	7020649887	aparnamohare2@gmail.com	<i>Aparna</i>
30)	Yogita Denge	7058437240	yogitadenge@gmail.com	<i>Yogita</i>
31)	Priyanshu Raut	9322725233	PriyanshuRaut56@gmail.com	<i>Priyanshu</i>
32)	Yashana Pandey	9156035237	pandeykns@gmail.com	<i>Yashana</i>
33)	Vaishnavi N Tonge	8421657943	Vaishnavitonge2001@gmail.com	<i>Vaishnavi</i>
34)	Chanchal K. Waghwan	7796016894	waghwanitara@gmail.com	<i>Chanchal</i>
35)	Muskan Kulkarni	9156887239	muskanulkarni@gmail.com	<i>Muskan</i>
36)	Priya Sharma	8010764819	priya19012004sharma@gmail.com	<i>Priya</i>
37)	Aakansha Maital	8010923662	aakanshamaital@gmail.com	<i>Aakansha</i>
38)	Siddhi B. Jwari	8087143696	siddhijwari0121@gmail.com	<i>Siddhi</i>
39)	Sunaina Chichonde	8530970132	sunainachichonde@gmail.com	<i>Sunaina</i>
40)	Ashlesha Khadgi	7820929579	ashleshakhadgi@gmail.com	<i>Ashlesha</i>
41)	Ghanashree U. Phemane	774900320	ghanashreephemane@gmail.com	<i>Ghanashree</i>
42)	Dhanashree neware	9359909913	DhanashreeNeware786@gmail.com	<i>Dhanashree</i>
43)	Krutika S. Pokale	9021533341	pokalekrutika@gmail.com	<i>Krutika</i>

Signature of:

Abhay
Programme In-charge

Abhay
IQAC Coordinator
CO ORDINATOR
INTERNAL QUALITY ASSURANCE CELL
DHARAMPETH, M. P. DEO MEMORIAL &
SCIENCE COLLEGE, NAGPUR

Abhay
Principal
PRINCIPAL
Dharampeth M.P. Deo Memorial
Science College, Nagpur-440033



DHARAMPETH M. P. DEO MEMORIAL SCIENCE COLLEGE, NAGPUR
INTERNAL QUALITY ASSURANCE CELL (IQAC)

Activity Report

Date: 18/02/23

Name of Organizing Department or Committee: Zoology

Name of the activity: Preparation of chart on Prokaryotic and eukaryotic cell
Suggested CRITERION point if any: Criteria I

Date of Activity: 17/02/2023

Place of Activity: Department of Zoology, Nagpur

Name of Guest Speaker judge/s or Chief Guest/s if any: NA

Title of the Activity: Preparation of chart on Prokaryotic and eukaryotic cell

Number of Participants: 27

Name of the Teacher In-charge / Convener: Dr. P.D.Khandelwal

Names of other Committee Members / Staff: Dr. K. M. Paturkar

OUTCOME of the Activity with respect to mission vision of the institute and or academics:

The Objective behind to Prepare chart on Cell is to evaluate the knowledge of the participants within academics as well as beyond academics and to make them familiar with the structure of cell. Students get in depth knowledge about animal cell, plant cell, tissues and their functions, Student get more knowledge by preparing chart.

Activity with newspaper coverage if any: NIL

Activity data save in PC of: Zoology Department/personal laptop



Dr. Pooja Khandelwal

Name & Signature of Teacher In-charge

Prof. Pitambar Humane

IQAC Coordinator

CO ORDINATOR
INTERNAL QUALITY ASSURANCE CELL
DHARAMPETH, M. P. DEO MEMORIAL &
SCIENCE COLLEGE, NAGPUR

Dr. Akhilesh Peshwe

Principal

Principal

Dharampeth M. P. Deo Memorial
Science College, NAGPUR.



DHARAMPETH M. P. DEO MEMORIAL SCIENCE COLLEGE,
North Ambazari Road, Near Ambazari Lake, Nagpur- 440033
DATA VALIDATION & VERIFICATION (DVV)

Name of the Programme : Preparation of chart on Prokaryotic & Eukaryotic cell.
 Date of the Programme : 17/02/23
 Name of Chief Guest if any : _____
 Name of Guest Speaker if any : _____

Sr. No.	Name of the Participant	Mobile Number	E-mail Id	Signature
1.	Ghanashree U. Dhokane	7774900320	ghanashreeghanashree@gmail.com	Ghanashree
2.	Yachang K. Pandey	9156035297	pandeyyachang54@gmail.com	Pandey
3.	Tanu T. Dhawale	8459543857	tanudhawale7@gmail.com	Dhawale
4.	Priya Bhogwan Sharma	8010764549	priyasharma19018004@gmail.com	Sharma
5.	Gurwasi R. Bhojare	8668335876	gurwanbhojare34@gmail.com	Graust
6.	Bally K. Wanjari	9326013213	keishanwanjaril2345@gmail.com	Bally
7.	Lucky A Vishwakarma	9579660186	lvishwakarma@240gmail.com	Vishwakarma
8.	Shreyas Jha	8983236002	semgeetajha@303@gmail.com	Jha
9.	Riya Singh	9595649831	riya2307@gmail.com	Riya
10.	Siddhi Tiwari	8087143696	siddhitiwari0721@gmail.com	Siddhi Tiwari
11.	Muskan Kulkarni	9156889239	muskankulkarni@gmail.com	Muskan
12.	Kastika Deshmukh	9699720960	kastikamd@gmail.com	Kastika
13.	Ritika Sondhiya	9175581655	ritikasondhiya@gmail.com	Ritika
14.	Anshul Yadav	9156494085	anshulyadav01521@gmail.com	Anshul

Signature of Programme In-charge

CO-ORDINATOR
INTERNAL QUALITY ASSURANCE CELL
DHARAMPETH, M. P. DEO MEMORIAL &
SCIENCE COLLEGE, NAGPUR

Principal
Dharampeth M. P. Deo Memorial
Science College, NAGPUR



DHARAMPETH M. P. DEO MEMORIAL SCIENCE COLLEGE,
North Ambazari Road, Near Ambazari Lake, Nagpur- 440033

DATA VALIDATION & VERIFICATION (DVV)

Sr. No.	Name of the Participant	Mobile Number	E-mail Id	Signature
15	Chanchal. K. Waghware	7796016894	waghwaremitara@gmail.com	chanchal
16	Krutika S. Pokale	9021533341	pokalekrutika6@gmail.com	Kspokale
17	Khushi. K. Rewade	9588445994	Khushirewade@gmail.com	Rewade
18	Chiranjiv. S. Gajbhiye	8329412694	Cgajbhiye17@gmail.com	Gajbhiye
19	Aakansha Y maital	8010923662	aakanshamaital@gmail.com	Aakansha
20	Sunaina Chichonde	8530970132	Sunainachichonde@gmail.com	Sunaina
21	Ashalesha Khadgi	7820929579	AshaleshaKhadgi@gmail.com	Ashalesha
22	Vaidhi Trak	7558499191	Vaidhitrak27@gmail.com	Vaidhi
23	Umanj Warkhi	9822428500	umanguwarkhi@gmail.com	Umanj
24	Dhanashree Neusare	9353909913	dhanashreeneusare786@gmail.com	Dhanashree
25	Meenal choudhary	9529014604	meenalchoudhary2002@gmail.com	Meenal
26	Pratiksha Mashram	8459070338	pratikshamashram14@gmail.com	Pratiksha
27	Pranali P. Y. Chavhare	9699654562	pranaliclavhare03@gmail.com	Pranali

Signature of
Programme in-charge

CO ORDINATOR
INTERNAL QUALITY ASSURANCE CELL
DHARAMPETH, M. P. DEO MEMORIAL &
SCIENCE COLLEGE, NAGPUR

Principal
Dharampeth M. P. Deo Memorial
Science College, NAGPUR



DHARAMPETH M. P. DEO MEMORIAL SCIENCE COLLEGE, NAGPUR

INTERNAL QUALITY ASSURANCE CELL (IQAC)

Activity Report

Date: 21-02-2023

Name of Organizing Department or Committee: Department of Statistics.

Name of the activity: Analysing the data using large sample test for single mean.

Suggested CRITERION point if any:

Date of Activity: 21st February 2023

Place of Activity: Statistics lab

Name of Guest Speaker/s or Judge/s or Chief Guest/s if any: N.A.

Title of the Activity: Analysing the data using large sample test for single mean.

Number of Participants: 08

Name of the Teacher: Gauri Sinekar

Names of other Committee Members / Staff: N.A.

OUTCOME of the Activity with respect to mission vision of the institute and or academics:

The income data of workers of factory was given to the students. This data based on large sample test and follows Univariate normal distribution. Student revised the topic of univariate normal distribution in large sample test after understanding the question. Students found out the result. After solving this activity, student got knowledge about large sample test for the mean of univariate normal distribution.

Activity with newspaper coverage if any: No

Activity data save in PC of: Department of Statistics

Prof. Pitambar Humane
IQAC Coordinator

CO ORDINATOR
INTERNAL QUALITY ASSURANCE CELL
DHARAMPETH, M. P. DEO MEMORIAL &
SCIENCE COLLEGE, NAGPUR

Name & Signature of Teacher In-charge

Dr. Akhilesh Peshwe
Principal

PRINCIPAL
Dharampeth M. P. Deo Memorial
Science College, Nagpur.



DHARAMPETH M. P. DEO MEMORIAL SCIENCE COLLEGE, NAGPUR

INTERNAL QUALITY ASSURANCE CELL (IQAC)

Activity Report

Date: 21-02-2023

Name of Organizing Department or Committee: Department of Statistics.

Name of the activity: Calculate mean weight of 80 students in a class.

Suggested CRITERION point if any:

Date of Activity: 21 feb 2023

Place of Activity: Statistics lab

Name of Guest Speaker/s or Judge/s or Chief Guest/s if any:

Title of the Activity: Calculate mean weight of 80 students in a class.

Number of Participants: 22

Name of the Teacher: Durga hingwe

Names of other Committee Members / Staff: N.A.

OUTCOME of the Activity with respect to mission vision of the institute and or academics:

Weighted means are useful in a wide variety of scenarios in our daily life. A students uses a weighted mean in order to calculate their percentage grade in a course.

Activity with newspaper coverage if any: No

Activity data save in PC of: Department of Statistics

Prof. Pitambar Humane
IQAC Coordinator

Name & Signature of Teacher In-charge

Dr. Akhilesh Peshwe
Principal

Dharampeth M.P. Deo Memorial
Science College, Nagpur.

CO ORDINATOR
INTERNAL QUALITY ASSURANCE CELL
DHARAMPETH, M. P. DEO MEMORIAL &
SCIENCE COLLEGE, NAGPUR



DHARAMPETH M. P. DEO MEMORIAL SCIENCE COLLEGE NAGPUR

Department of Statistics

Class: B.Sc. Sem.- II

NEP ACTIVITY

Paper II

Unit- J

Name of the Teacher: Durga C. Hingwe

Date: 21-02-23

Title of Activity: calculate mean weights of 80 students in a class

Sr. No.	Name of Student	Batch	Mobile No.	Email ID	Signature
1	Aranali V. Gupta	SCOM	7020069377	ar0991537@gmail.com	<u>Aranali</u>
2	Sonia Niwal	SCOM	7058425021	niwalsonia70@gmail.com	<u>Sonia</u>
3	Divyani V. Zagde	SCOM	9022866318	divyanizagde@gmail.com	<u>Divyani</u>
4	Megha S. Ballav	PSM	9421728880	meghaballav@gmail.com	<u>Megha</u>
5	Mudit Khirdekar	SCOM	8055329357	muditkhirdekar@gmail.com	<u>Mudit</u>
6	Prachiya Tiapude	SCOM	8010362232	prachiyatiapude@gmail.com	<u>Prachiya</u>
7	Veena Borikar	SCOM	9322016921	veena1692kar14@gmail.com	<u>Veena</u>
8	Varsha Turkar	F2	9373688988	varshaturkar488@gmail.com	<u>Varsha</u>
9	Nisha Kosarkar	F2	9890996645	nishakosarkar4933@gmail.com	<u>Nisha</u>
10	Rutika Yadav	F2	8446085949	yadavarutika494@gmail.com	<u>Rutika</u>
11	Jahvi Jage	F2	7385060871	janhvjage08@gmail.com	<u>Jahvi</u>
12	Jagruti Fulkawar	F2	8767911307	jagrutifulkawar@gmail.com	<u>Jagruti</u>
13	Jarwi Khode	F2	7395066634	jarwikhode892@gmail.com	<u>Jarwi</u>
14	Jashila Deshpande	F2	9130091560	jashiladeshpande21@gmail.com	<u>Jashila</u>
15	Janvi Kinnapure	F2	7058335243	janvikinnapure@gmail.com	<u>Janvi</u>
16	Utkarsha Ingale	F2	749159178	utkarshaingale9@gmail.com	<u>Utkarsha</u>
17	Devashi Kakde	F2	9021344265	shakatedevashi@gmail.com	<u>Devashi</u>
18	Sakshi Mishra	F2	0529889915	smishra39653@gmail.com	<u>Sakshi</u>
19	Jahvi Laibin	F2	8446510539	janhvilaibin@gmail.com	<u>Jahvi</u>
20	Vidya Lohi	F2	7020963219	vidyalohi@gmail.com	<u>Vidya</u>
21	Pranali Shankar	F2	8767581278	pdanha@gmail.com	<u>Pranali</u>
22	Nayan N. Walthare	F1	7841870747	Nayanwalthare4@gmail.com	<u>Nayan</u>

D. Hingwe
Signature of Teacher

D. Hingwe
Teacher incharge



DHARAMPETH M. P. DEO MEMORIAL SCIENCE COLLEGE, NAGPUR
INTERNAL QUALITY ASSURANCE CELL (IQAC)

Activity Report

Date: 24/02/2023

Name of Organizing Department or Committee: Chemistry

Name of the activity: Inter Collegiate Seminar Competition

Suggested CRITERION point if any: I

Date of Activity: : 22/02/2023

Place of Activity: Dharampeth M. P. Deo Memorial Science College Nagpur

Name of Guest Speaker/s or Judge/s or Chief Guest/s if any: Dr.Mrs.Charita Patil,Dr.Ratiram Choudhari,Dr.Ravin Jugade, Mr.Sachin Palsokar

Title of the Activity:LateDr.Suresh D.Palsokar Memorial, Intercollegiate Seminar competition.

Number of Participants: 38

Name of the Teacher In-charge / Convener: Dr Vaishali Meshram

Names of other Committee Members/Staff: Dr.Deepika Brijpuria, Dr.Sandip Bhivgade, Ms.Niharika Sute, Mrs.Avanti Kulkarni

OUTCOME of the Activity with respect to mission vision of the institute and or academics:
Students from different colleges were participated in the competition, Seminars were presented on different topic, Prizes were distributed by Judges.

Activity with newspaper coverage if any: Nil

Activity data save in PC of: _Chemistry

Note: Kindly share geotag photographs separately along with report on igacdsc2022@gmail.com



Prof. Pitambar Humane

CO ORDINATOR

INTERNAL QUALITY ASSURANCE CELL
DHARAMPETH, M. P. DEO MEMORIAL &
SCIENCE COLLEGE, NAGPUR

Name & Signature of Teacher In-charge

Dr. Akhilesh Peshwe

Principal

Principal
Dharampeth M.P. Deo Memorial
Science College, Nagpur.



DHARAMPETH M. P. DEO MEMORIAL SCIENCE COLLEGE,
North Ambazari Road, Near Ambazari Lake, Nagpur- 440033

DATA VALIDATION & VERIFICATION (DVV)

Name of the Programme : Inter Collegiate Power Point Presentation Competition
Date of the Programme : 22/02/23
Name of Chief Guest if any : Dr. Chaita Patil, Dr. Ratiram Choudhary
Name of Guest Speaker if any : -

Sr. No.	Name of the Participant	Mobile Number	E-mail Id	Signature
1.	Ritika V. Khandelwal	7558531158	khandelwalritika97@gmail.com	
2.	Sanika S. Bawankar	9529128867	sanikabawankar@gmail.com	
3.	Pranali J. Badewarik	8329269608	Pjbadewarik02@gmail.com	
4.	Mehandi V. Chandankhede	8698012738	mvc310702@gmail.com	
5.	Srushti K. Bahadure	9356918843	bahadure.srushti30@gmail.com	
6.	Kartik Adlakhia	8530597159	k.adlakhia@gmail.com	
7.	Tanmay Bhule	7697250831	tanmaybhule90@gmail.com	
8.	Khushi Rane	7721837118	Khushi.rane.2824@gmail.com	
9.	Akshat Hatwar	7741099857	Akshat.hatwar.923@gmail.com	
10.	Hareshal Bhandekar	9356439701	hareshalbhandekar7@gmail.com	

Signature of:

Programme In-charge

CO-ORDINATOR
INTERNAL QUALITY ASSURANCE CELL
DHARAMPETH, M. P. DEO MEMORIAL
SCIENCE COLLEGE, NAGPUR

Principal
Dharampeth M.P. Deo Memorial
Science College, Nagpur



DHARAMPETH M. P. DEO MEMORIAL SCIENCE COLLEGE,
North Ambazari Road, Near Ambazari Lake, Nagpur- 440033

DATA VALIDATION & VERIFICATION (DVV)

Name of the Programme : Intercollegiate Power point presentation Competition

Date of the Programme : 22/02/23

Name of Chief Guest if any : Dr. Chaitali Patil, Dr. Ratiram choudhary

Name of Guest Speaker if any : - pcmt

7-10
7-10
7-10
7-10
7-10
7-10
7-10
7-10
7-10
7-10

Sr. No.	Name of the Participant	Mobile Number	E-mail Id	Signature
11	Pragya R Jha	9665852975	pragya01697@gmail.com	<u>[Signature]</u>
12	Chaitali M. Bumbade	9359540394	chaitali2020b@gmail.com	<u>Chaitali</u>
13	Akanksha R. Yeluce	8767935524	Akankshayeluce@gmail.com	<u>Akanksha</u>
14	Prियानशि P. Singh	7219259020	priyanshisingh1804@gmail.com	<u>Singh</u>
15	Sakshi Surendra Moon	79 7745827736	sakshim3030@gmail.com	<u>Smoon</u>
16	Raji. N. Pathan	8669595198	Rajikhan66024@gmail.com	<u>R Pathan</u>
17	Muskan Sheikh	8055474633	muskan2019sss@gmail.com	<u>Muskan</u>
18	Nikita Ekre	7972190515	shi	<u>NEkre</u>
19	Shivani Bhute.	9302900209	shivaniabhute@gmail.com	<u>Sbhute</u>
20	Khushi D. Aundhkar	8167279513	khushiandhkar@6529mail.com	<u>Khushi</u>

Signature of:
[Signature]
Programme In-charge

[Signature]
IQAC Coordinator
CO ORDINATOR
INTERNAL QUALITY ASSURANCE CELL
DHARAMPETH, M. P. DEO MEMORIAL &
SCIENCE COLLEGE, NAGPUR

[Signature]
Principal
Principal
Dharampeth M.P. Deo Memorial
Science College, Nagpur.



DHARAMPETH M. P. DEO MEMORIAL SCIENCE COLLEGE,
North Ambazari Road, Near Ambazari Lake, Nagpur- 440033

DATA VALIDATION & VERIFICATION (DVV)

T-7	21	Supriya Patle	7757871925	PatleSupriya0123@gmail.com	Patle
T-7	22	Damini M. Bandbuche	8275105785	bandbuchedamini@gmail.com	D. Bandbuche
T-8	23	Prachi Subhash Waghale	8767914118	Prachiwaghale11@gmail.com	Prachi Waghale
T-8	24	Nikita Dipak Shebe	9021019101	nikita.shebe2019@gmail.com	Nshebe
T-8	25	Aachal Shudhohadhan Wagh	9579643389	aachalwagh2003@gmail.com	Aachal Wagh
T-9	26	Nikita Rahangdale	9307723308	nikitarahangdale2005@gmail.com	Nikita Rahangdale
T-9	27	Divya Bondre	8668454925	divyabondre3@gmail.com	Divya Bondre
T-10	28	Pallavi Bhagat	9022654940	PallaviBhagat2008@gmail.com	P. Bhagat
T-8	29	Smriti Kukde	9075232517	SmritiKukde13@gmail.com	S. Kukde
T-8	30	Anushka S. Das	7058933157	adas04092001@gmail.com	Anushka Das
T-8	31	Raksha D. Dhote	7498511875	rakshadhote@gmail.com	R. Dhote
T-9	32	Tanusha P. Date	9766987406	tanusha97@gmail.com	T. Date
T-10	23	Megha S. Fulwar	8605399606	meghafulwar@gmail.com	M. Fulwar
	34	Daya Bondre	8662454925	dayabondre@gmail.com	Daya Bondre
	35	Aachal Wagh	95796433819	aachalwagh2003@gmail.com	Aachal Wagh
	36	Anushka Das	7058133157	adas@gmail.com	Anushka Das
	37	Suman Singh	7249465307	misssuman singh@gmail.com	Suman Singh
	38	Shivam Mawia	9607873102	Shivam mawia@gmail.com	Shivam Mawia

Signature of:

Programme In-charge

IQAC Coordinator

COORDINATOR

INTERNAL QUALITY ASSURANCE CELL
DHARAMPETH, M. P. DEO MEMORIAL &
SCIENCE COLLEGE, NAGPUR

Principal

Principal
Dharampeth M.P. Deo Memorial
Science College, Nagpur.



DHARAMPETH M. P. DEO MEMORIAL SCIENCE COLLEGE, NAGPUR

INTERNAL QUALITY ASSURANCE CELL (IQAC)

Activity Report

Date: 22nd February 2023

Name of Organizing Department or Committee : Electronics Department

Name of the Activity : Study of antennas in communication system

Suggested CRITERION point if any : Suggested criteria II

Date of Activity : 22nd February 2023

Place of Activity : Electronics Lab

Name of Guest Speaker/s or Judge/s or Chief Guest/s if any : Not applicable

Title of the Activity: Study of antennas in communication system

Based on Unit : 3(Paper I)

Class : Semester IV

Number of Participants : 17

Name of the Teacher In-charge / Convener: Prof. V. V. Rangari

OUTCOME of the Activity with respect to mission vision of the institute and or academics:

Students studied different antennas in communication system and their applications.

Prof. Pitambar Humane

IQAC Coordinator

CO ORDINATOR
INTERNAL QUALITY ASSURANCE CELL
DHARAMPETH, M. P. DEO MEMORIAL &
SCIENCE COLLEGE, NAGPUR

Prof. V. V. Rangari
Dr. V. V. Rangari
Professor & Head
Head of the Department
Department of Electronics
Dharampeth M.P. Deo Memorial
Science College, Nagpur

Dr. Akhlesh Peshwe
Principal
Principal
Dharampeth M.P. Deo Memorial
Science College, Nagpur.



DHARAMPETH M. P. DEO MEMORIAL SCIENCE COLLEGE, NAGPUR

Department of Electronics

Semester IV- (2022-23)

ACTIVITY (PAPER I – UNIT 3)

Sr. No.	Student Name	Mobile No.	Email ID
1	Janvi Ashok Kosarkar	8975756916	Janvikosarkar@gmail.com
2	Pratham Ankush Sitkare	9022553288	prathamsitkare@gmail.com
3	Jay Anilbhai Patil	7385436956	jay_patil0326@gmail.com
4	Urvashi Sunilrao Umathe	9527708361	pragatichaure01@gmail.com
5	Renuka Vishal Lande	7719951401	renukalande220@gmail.com
6	Rahul Ramesh Kawade	9359525716	kawaderahul042@gmail.com
7	Ankush Samma Gawade	7588194156	agawde5603@gmail.com
8	Yash Ravindra Khedekar	7020829422	yashkhedekar5@gmail.com
9	Prakhar Rajesh Buradkar	8329760853	prakhar.buradkar560@gmail.com
10	Bhagyarathi Ramvinay Pandey	9175302601	pandeybhagyarathi@gmail.com
11	Unnatital Chatrapal Chopde	9022627617	unnatichopde2002@gmail.com
12	Mansi Dilip Nandanwar	7709322027	mansinandanwar19@gmail.com
13	Aasmin Abdulkhalik Sheikh	8788490684	abdulkhalik563698@gmail.com
14	Tushar Wadhawe		
15	Prajwal Mulchand Bhade	9834016826	matesamu17@gmail.com
16	Durgesh Krishna Singh	7385310432	ds608531@gmail.com
17	Chetan Umashankar Bopche	9172484628	chetanbopche27@gmail.com

Name & Signature of Teacher In-Charge

Prof. Pitambar Humane
IQAC Coordinator

CO ORDINATOR
INTERNAL QUALITY ASSURANCE CELL
DHARAMPETH, M. P. DEO MEMORIAL &
SCIENCE COLLEGE, NAGPUR

Name & Signature of Head of the Department

Dr. Varsha V. Rangari
Professor & Head
Department of Electronics
Dharampeth M.P. Deo Memorial
Science College, Nagpur

Dr. Akhilesh Peshwe
Principal
Principal
Dharampeth M.P. Deo Memorial
Science College, Nagpur.



DHARAMPETH M. P. DEO MEMORIAL SCIENCE COLLEGE, NAGPUR
INTERNAL QUALITY ASSURANCE CELL (IQAC)

Activity Report

Date: 22.02.2023

Name of Organizing Department or Committee: Dept. of Home Science

Name of the activity: Discussion on generational health effects of iron deficiency anaemia and importance of combating it during childhood to reduce maternal mortality rate. (NEP 2022 Activity)

Suggested CRITERION point if any:

Date of Activity: 22.02.2023

Place of Activity: Classroom, Dept. of Home Science

Name of Guest Speaker/s or Judge/s or Chief Guest/s if any:

Title of the Activity: Discussion on generational health effects of iron deficiency anaemia and importance of combating it during childhood to reduce maternal mortality rate

Number of Participants: 10

Name of the Teacher In-charge / Convener: Mrs. Meghna Pandit

Names of other Committee Members / Staff:

OUTCOME of the Activity with respect to mission vision of the institute and or academics:

To create awareness about generational health effects of iron deficiency anaemia and importance of combating it during childhood to reduce maternal mortality rate.

Activity with newspaper coverage if any:

Activity data save in PC of: _____

Note: Kindly share geotag photographs separately along with report on igaedsc2022@gmail.com

Prof. Pitambar Humane
IQAC Coordinator
CO ORDINATOR

INTERNAL QUALITY ASSURANCE CELL
DHARAMPETH, M. P. DEO MEMORIAL &
SCIENCE COLLEGE, NAGPUR

Name & Signature of Teacher In-charge
(Mrs. Meghna Pandit)

Dr. Akhilesh Peshwe
PRINCIPAL

Dharampeth M. P. Deo Memorial
Science College, Nagpur-440033



Name of programme - Discussion on generational health effects of iron deficiency anaemia and importance of combating it during childhood to reduce maternal mortality rate.



DHARAMPETH M. P. DEO MEMORIAL SCIENCE COLLEGE,
North Ambazari Road, Near Ambazari Lake, Nagpur- 440033

Date - 22.02.2023

DATA VALIDATION & VERIFICATION (DVV)

1.	SAKSHI R. CHAKUNDE	7843018801	sakshichakunde@gmail.com	Schakunde
2.	shalu T. Pandhi	8329115380	shalupandhi19@gmail.com	Shalu
3.	Priya J. Chaudhari	4620384149	chaudhripriya220@gmail.com	Priya
4.	Anshikha U. Jaisankar	9021391207	anshikhajaisankar@gmail.com	Anshikha
5.	Gayatri N. Varma	9463287531	gayatri.varma50@gmail.com	Gayatri
6.	Aditi R. Vaidya	9075714591	aditi.vaidya619@gmail.com	Aditi
7.	bhavana Guwadasoni	8888437303	bhavraguwadasoni@gmail.com	Bhavans
8.	Minal L. Patle	7350730164	patleminal83@gmail.com	Minal
9.	Neha R. Vishwakarma	8983534173	nehavishwakarmar19@gmail.com	Neha
10.	Anchal Chakande	9309560449	anchalchakande@gmail.com	Anchal

Signature of:

M. Pandit
Programme In-charge

(Mrs. Meghna Pandit)

[Signature]

CO ORDINATOR
INTERNAL QUALITY ASSURANCE CELL
DHARAMPETH, M. P. DEO MEMORIAL &
SCIENCE COLLEGE, NAGPUR

[Signature]
PRINCIPAL

Dharampeth M. P. Deo Memorial
Science College, Nagpur-440033



DHARAMPETH M. P. DEO MEMORIAL SCIENCE COLLEGE, NAGPUR
INTERNAL QUALITY ASSURANCE CELL (IQAC)
NEP Activity Report

Date: 24/02/2023

Name of Organizing Department or Committee: Chemistry Department

Name of the activity: NEP Activity Report (Sem- IV, Unit-II)

Suggested CRITERION point if any: Criteria II

Date of Activity: 22/02/2023

Place of Activity: Chemistry Department Laboratory

Name of Guest Speaker/s or Judge/s or Chief Guest/s if any: Nil

Title of the Activity: Demonstration of EMF and its Applications

Number of Participants: 33

Name of the Teacher In-charge / Convener: Ms. Niharika A. Sute

Names of other Committee Members / Staff: Dr. Vaishali Meshram

OUTCOME of the Activity with respect to mission vision of the institute and or academics:

This is student centric activity. By this Demonstration, student studied that Electromotive force (EMF) is equal to the terminal potential difference when no current flows. Cell, solar cell, battery, generator, thermocouple, dynamo, etc are examples of sources of emf. Emf measurements is the determination of the pH of solution and used to determine whether an electrochemical cell is galvanic or not.

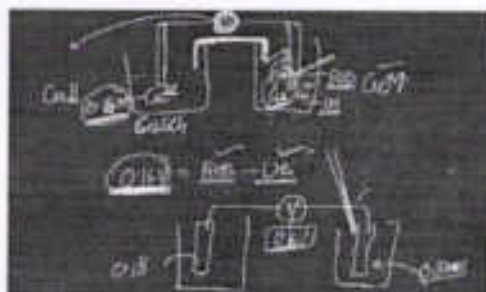

Activity with newspaper coverage if any: Nil

Activity data save in PC of: Chemistry Department

Note: Kindly share geotag photographs separately along with report on iqacdsc2022@gmail.com

Prof. Pitambar Humane
IQAC Coordinator

(Niharika A. Sute)
Name & Signature of Teacher In-charge

Dr. Akhilesh Peshwe
Principal



DHARAMPETH M. P. DEO MEMORIAL SCIENCE COLLEGE,
North Ambazari Road, Near Ambazari Lake, Nagpur- 440033

DATA VALIDATION & VERIFICATION (DVV)

NEP Activity-2 on Unit-II, Paper-I (Sem-IV)
Name of the Programme : Demonstration of ERF & its applications
Date of the Programme : 22/02/2023
Name of Chief Guest if any : —
Name of Guest Speaker if any : —

Sr. No.	Name of the Participant	Mobile Number	E-mail Id	Signature
1)	Kalpna D. Suhagpure	9579236712	kalpanasuhagpure7@gmail.com	
2)	Vaishnavi R. Nandpure	9322439916	vaishnavinandpure8@gmail.com	
3)	Arijali S. Mishra	9825604513	arijalimishra4954@gmail.com	
4)	Pooja S. Itankar	9156973252	poojaitankar387@gmail.com	
5)	Twinkal G. Lakhande	8149126609	twinkalalakhande14@gmail.com	
6)	Shrawani R. Wankhede	9058368837	shrawaniwankhede1@gmail.com	
7)	Tina R. Rahangdate	9921776769	tinarahangdate@gmail.com	
8)	Chhakuli G. Wadikar	9325047307	chhakuliwadikar@gmail.com	
9)	Vaishnavi R. Lakhe	8669594864	chhakuli.lakhe56@gmail.com	
10)	Vamila V. Bondre	9370673867	bondrevamila.2000@gmail.com	

Signature of A. Sute

Programme In-charge
(NPhareika A. Sute)

IQAC Coordinator
CO ORDINATOR
INTERNAL QUALITY ASSURANCE CELL
DHARAMPETH, M. P. DEO MEMORIAL &
SCIENCE COLLEGE, NAGPUR

Principal

PRINCIPAL
Dharampeth M.P. Deo Memorial
Science College, Nagpur-440033



DHARAMPETH M. P. DEO MEMORIAL SCIENCE COLLEGE,
North Ambazari Road, Near Ambazari Lake, Nagpur- 440033

DATA VALIDATION & VERIFICATION (DVV)

1)	Shraddha Dhadwale	8888264004	shraddhadhadwale124@gmail.com	<u>Shraddha</u>
12)	Vaibhavi Shende	8080640782	Vaibhavishende91@gmail.com	<u>Vaibhavi</u>
13)	Mansi T. Mate	8668891807	mansi19182@gmail.com	<u>Mansi</u>
14)	Juhi S. Chaudhari	8669248944	chaudharijuhi12@gmail.com	<u>Juhi</u>
15)	Sakshi S. Meshram	9145355783	Sakshimeshram20@gmail.com	<u>Sakshi</u>
16)	Jyotsna D. Warkar	7447366023	jyotsnawarkar20@gmail.com	<u>Jyotsna</u>
17)	Lania Midhat A. Raja	8975726700	midhatania@gmail.com	<u>Lania</u>
18)	Jyoti Sharma	8669736380	jyotis8390@gmail.com	<u>Jyoti</u>
19)	Tejas V. Rewade	7796027056	tejasrewade8@gmail.com	<u>Tejas</u>
20)	Aman Dongre	7709217312	amandongre2003@gmail.com	<u>Aman</u>
21)	Siddhant Hirkan	9579092931	hirkanesiddhant@gmail.com	<u>Siddhant</u>
22)	Rupesh Chokre	8805887370	chokrerupesh@gmail.com	<u>Rupesh</u>
23)	Jasraj Paliwal	9370820325	jasrajpaliwal47@gmail.com	<u>Jasraj</u>
24)	Nupur Sharma	8822042259	nupursharma258@gmail.com	<u>Nupur</u>
25)	Kavita Mishra	9657199261	kanit889@gmail.com	<u>Kavita</u>
26)	Mansi Badole	7796308467	mansibadole@gmail.com	<u>Mansi</u>

Signature of:

A. Sute

Programme In-charge

(Niharika A. Sute)

IQAC Coordinator

CO ORDINATOR

INTERNAL QUALITY ASSURANCE CELL
DHARAMPETH, M. P. DEO MEMORIAL &
SCIENCE COLLEGE, NAGPUR

Principal

PRINCIPAL

Dharampeth M. P. Deo Memorial
Science College, Nagpur-440033



DHARAMPETH M. P. DEO MEMORIAL SCIENCE COLLEGE, NAGPUR
INTERNAL QUALITY ASSURANCE CELL (IQAC)
Activity Report

Date: 22/02/2023

Name of Organizing Department or Committee: Home Science Department.

Name of the activity: Event Management (Floral Carpet Workshop)

Suggested CRITERION point if any: Criteria II & V

Date of Activity: 22/02/2023

Place of Activity: Classroom

Name of Guest Speaker/s or Judge/s or Chief Guest/s Resource Person if any: Ms. Ankita Wankhede

Title of the Activity: Floral Carpet Workshop

Number of Participants: 11 students of Semester IInd participate in the activity.

Name of the Teacher In-charge / Convener: Ms. Ankita Wankhede

Names of other Committee Members / Staff: Mrs. Manju Deshpande

OUTCOME of the Activity with respect to mission vision of the institute and or academics:

1. They learn to create something new.
2. Students got knowledge of different types of flower or application of Element of art and application of Principles of art in floral carpet (rangoli). From this workshop students learn about the elements of art, relation of colour combination.

Activity with newspaper coverage if any: _____

Activity data save in PC of: Home Science Staff Room Desktop

Note: Kindly share geotag photographs separately along with report on iqaodsc2022@gmail.com



Prof. Pitambar Humane
IQAC CO-ORDINATOR
INTERNAL QUALITY ASSURANCE CELL
DHARAMPETH, M. P. DEO MEMORIAL &
SCIENCE COLLEGE, NAGPUR

Name & Signature of Teacher In-charge

Dr. Akhilesh Peshwe
Principal
PRINCIPAL
Dharampeth M.P. Deo Memorial
Science College, Nagpur-440033



DHARAMPETH M. P. DEO MEMORIAL SCIENCE COLLEGE,
North Ambazari Road, Near Ambazari Lake, Nagpur-440033

DATA VALIDATION & VERIFICATION (DVV)

Name of the Programme : Workshop on Floral Carpet
Date of the Programme : 22/02/2023
Name of Chief Guest if any : _____
Name of Guest Speaker if any : _____

Sr. No.	Name of the Participant	Mobile Number	E-mail Id	Signature
1.	Anchal. D. Kokande	9309560449		
2.	Ashwini N. Pandey	8308621072		
3.	Aditi. R. Vaidya	9075714591	aditivaidya619@gmail.com	
4.	Minal. L. Pater	7350730164	Patterminal83@gmail.com	
5.	Hemlata D. Verma	7517058379	vermahemlata957@gmail.com	
6.	SARSHI. R. CHAKUNDE	7843018801	sakshichakunde@gmail.com	
7.	Neha R. Vishwakarma	8983554175	neha.vishwakarma85285@gmail.com	
8.	Anshikha U. Jaiswarikar	9021391207	anshikhajaiswarikar@gmail.com	
9.	Preerna J. Chaudhari	7620384149	chaudharipreerna294@gmail.com	
10.	Artha. Bhowray	9156009306	arthabhowray@gmail.com	

Signature of:

Programme In-charge
Ms. Ankita Inankhede

IQAC Coordinator
CO ORDINATOR
INTERNAL QUALITY ASSURANCE CELL
DHARAMPETH, M. P. DEO MEMORIAL &
SCIENCE COLLEGE, NAGPUR

Principal
PRINCIPAL
Dharampeth M. P. Deo Memorial
Science College, Nagpur-440033

To,

The HOD, Home Science Department.

Dharampeth M.P. Deo Memorial

Science College Nagpur.

Date :- 18/02/2023

Subject: Request for conducting Floral Carpet workshop for B.Sc Home Science Semester II students.

Respected Madam,

This is to request you to please grant us permission for conducting floral carpet workshop for B.Sc Home Science Semester II students on 20/02/2023

Hope you will grant us permission for the above.

Thanking You,

Yours Sincerely,





DHARAMPETH M. P. DEO MEMORIAL SCIENCE COLLEGE, NAGPUR

INTERNAL QUALITY ASSURANCE CELL (IQAC)

Activity Report

Date: 23/2/2023

Name of Organizing Department or Committee: Department of Mathematics

Name of the activity: NEP based Short note on the work of Mathematician (Daniel Bernoulli's) for B.Sc. Semester-II

Suggested CRITERION point if any: Criterion I.

Date of Activity: 23/02/2023

Place of Activity: Class room

Name of Guest Speaker/s or Judge/s or Chief Guest/s if any: NA

Title of the Activity: Short note on the work of Mathematician (Daniel Bernoulli's)

Activity with newspaper coverage if any: No

Number of Participants: B.Sc. Semester-II Students (45)

Name of the Teacher In-charge / Convener: Dr. N. P. Gaikwad

Names of other Committee Members / Staff: Mr. Roshan Thakre

OUTCOME of the Activity with respect to academics:

Daniel Bernoulli was a Dutch-born member of the Swiss mathematical family. His most important work considered the basic properties of fluid flow, pressure, density and velocity, and gave the Bernoulli principle. If u and v are functions of x , then the Bernoulli's rule is $\int u dv = uv - \int u'v + \int u'v^2 - \dots$. For the following problems we have to apply the integration by parts two or more times to find the solution. In this case Bernoulli's formula helps to find the solution easily

DVV: Enclosed.

Prof. Pitambar Humane

IQAC Coordinator

PRINCIPAL

Dharampeth M.P. Deo Memorial
Science College, Nagpur-440033

Name & Signature of Teacher In-charge

Dr. Akhilesh Peshwe

Principal
PRINCIPAL

Dharampeth M.P. Deo Memorial
Science College, Nagpur-440033

2

2



DHARAMPETH M. P. DEO MEMORIAL SCIENCE COLLEGE,
North Ambazari Road, Near Ambazari Lake, Nagpur- 440033

DATA VALIDATION & VERIFICATION (DVV)

Name of the Programme : NEP based short note on the work of
 Date of the Programme : 23/02/2023 / Mathematician (Daniel
 Name of Chief Guest if any : Bernoulli's) for
 Name of Guest Speaker if any : B.Sc Semester - II

Sr. No.	Name of the Participant	Mobile Number	E-mail Id	Signature
1.	Simran Dhimale	7666330683	simrandhimale80@gmail.com	Dhimale
2)	Tejus R Chetwadkar	9600662119	tejuschetwadkar@gmail.com	Tejus
3)	Manali D. Phillkar	9922727616	manaliphillkar@gmail.com	Manali
4)	Isha I. Waghmare	8855919474	ishawaghmare9174@gmail.com	Isha
5)	Janhvi M Jage	7385060871	janhvi.jage08@gmail.com	Janhvi
6)	Janhvi Laibey	8446510539	Janvilaibey@gmail.com	Janhvi
7)	Divyani Zagade	9022866318	divyanizagade@gmail.com	Zagade
8)	Saniksha Panchbude	9763075890	saniksha.panchbude@gmail.com	Saniksha
9)	Vassha Turkar	9373650950	vasshaturkar988@gmail.com	Vassha
10)	Rutika Yadav	8446085943	yadavrutika139@gmail.com	Rutika

Signature of:

Programme In-charge

IQAC Coordinator

IQAC Co-ordinator

Dharampeth M.P. Deo Memorial
Science College, Nagpur-440033

Principal
PRINCIPAL

Dharampeth M.P. Deo Memorial
Science College, Nagpur-440033



DHARAMPETH M. P. DEO MEMORIAL SCIENCE COLLEGE,
North Ambazari Road, Near Ambazari Lake, Nagpur- 440033

DATA VALIDATION & VERIFICATION (DVV)

11)	Janvi Khode	7385066634	JanviKhode042@gmail.com	JanviKhode
12)	Parthikha Borseve	9579830818	ParthikhaBorseve49@gmail.com	ParthikhaBorseve
13)	Pranali Y. Gupta	7020069377	20991537@gmail.com	Gupta
14)	Tanuja . G. Yelure	952944565	tanujayelure728@gmail.com	T.Y. Yelure
15)	Priyanshu Singh	9527710380	Priyanshu.singh.joc2@gmail.com	P. Singh
16)	Vibhanshu Thane	9511232204	Vibhanshu.thane@gmail.com	Vibhanshu
17)	Tejas Dongre	9322578918	Tej9874k@gmail.com	Tejas
18)	Vedant O. Umethkar	9069932753	umethkar.vedant@gmail.com	Vedant
19)	Tejas R Chetmelwar	964662119	tejaschetmelwar@gmail.com	Tejas
20)	Sakshi Mishra	9529889315	Smishra939683@gmail.com	Smishra
21)	Badal G. Samkuwar	7448247750	badal.samkuwar7@gmail.com	Badal
22)	Gendal B. Machade	9112142728	nikhilmachade2008@gmail.com	Gendal
23)	Uday C. Baghele	8459543609	bagheleuday@gmail.com	Uday
24)	Tannu A. Vasthi	9322044903	tannuvasthi@gmail.com	Vasthi
25)	Aniket J. Bawarikar	3767219301	Aniket.Bawarikar@gmail.com	Aniket
26)	Bhagyashali D. Newase	7796434177	Sakshinewase2017@gmail.com	B.D. Newase

Signature of:

Programme In-charge

IQAC Coordinator

IQAC Co-ordinator

Dharampeth M.P. Deo Memorial
Science College, Nagpur-440033

Principal

PRINCIPAL

Dharampeth M.P. Deo Memorial
Science College, Nagpur-440033



DHARAMPETH M. P. DEO MEMORIAL SCIENCE COLLEGE,
North Ambazari Road, Near Ambazari Lake, Nagpur- 440033

DATA VALIDATION & VERIFICATION (DVV)

27)	Nikhil Kale	9529113941	nikhilkale1508@gmail.com	nikhilkale
28)	Surej M Mishra	9730639023	surej.mishra@gmail.com	Surej
29)	Trishabh Saha	9087300294	trishabhkante2000@gmail.com	Trishabh
30)	Abhishek Singh	8208948107	abhi0882005@gmail.com	abhishek
31)	Rohit Pandey	8767788703	rp9356521@gmail.com	Rohit
32)	Sury Dubey	760201970190	surydubey144	Sury
33)	Manu P. Pal	7350450579	manupal735045@gmail.com	Manu
34)	Mahima Khare	9545918678	mahimakhare11@gmail.com	Mahima
35)	Nayan N. Wathal	7841870947	nayanwathal22@gmail.com	Nayan
36)	Shruthika G. Pise	9322316336	shruthika.pise67@gmail.com	Shruthika
37)	Aman Koen	9028839552	koen787@gmail.com	Aman
38)	Pratik Chalkh	902640532	pratikchalkh07@gmail.com	Pratik
39)	Pratish Golait	9579343851	Pratishgolait93@gmail.com	Pratish
40)	Tanu A. Singlu	8806355808	Tanusinglu13492@gmail.com	Tanu
41)	Prachi S. Gaitkand	7385412955	Prachigaitkand@gmail.com	Prachi
42)	Divyani G. Zade	7972403069	divyanizade2005@gmail.com	Divyani

Signature of:

Programme In-charge

IQAC Coordinator

IQAC Co-ordinator
Dharampeth M.P. Deo Memorial
Science College, Nagpur-440033

Principal

PRINCIPAL
Dharampeth M.P. Deo Memorial
Science College, Nagpur-440033



DHARAMPETH M. P. DEO MEMORIAL SCIENCE COLLEGE, NAGPUR
INTERNAL QUALITY ASSURANCE CELL (IQAC)

Activity Report

Date: 23.2.23

Name of Organizing Department or Committee: Home Science Department

Name of the activity: Report on Demographic status of elderly.

Suggested CRITERION point if any: I & II.

Date of Activity: 23.2.23

Place of Activity: Classroom

Name of Guest Speaker/s or Judge/s or Chief Guest/s if any:

Title of the Activity: Study the Demography of Elderly Population

Number of Participants: Semester 4 (13 students)

Name of the Teacher In-charge / Convener: Mrs M.M.Deshpande

Names of other Committee Members / Staff:

OUTCOME of the Activity with respect to mission vision of the institute and or academics:

To make the youth sensitized towards the elderly, understand the issues & know the importance of their well being

Activity with newspaper coverage if any:

Activity data save in PC of: Mrs M MDeshpande

Note: Kindly share geotag photographs separately along with report on iqacdsc2022@gmail.com

Prof. Pitambar Humane

IQAC Coordinator

COORDINATOR
INTERNAL QUALITY ASSURANCE CELL
DHARAMPETH, M. P. DEO MEMORIAL
SCIENCE COLLEGE, NAGPUR

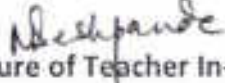
Name & Signature of Teacher In-charge

Dr. Akhilesh Peshwe
PRINCIPAL

Dharampeth M.P. Deo Memorial
Science College, Nagpur-440033



DHARAMPETH M. P. DEO MEMORIAL SCIENCE COLLEGE,
North Ambazari Road, Near Ambazari Lake, Nagpur- 440033

DATA VALIDATION & VERIFICATION (DVV)

Name of the Programme : Concept of Demographic Status of elderly (NEP)
Date of the Programme : 23.2.23
Name of Chief Guest if any : _____
Name of Guest Speaker if any : _____

Sr. No.	Name of the Participant	Mobile Number	E-mail Id	Signature
1.	Pragya S. Tiwari	6394098386	pragyatiwari1405@gmail.com	
2.	Ojaswi Wankhede	8767699751	ojaswiwankhede@gmail.com	
3.	Avani S. Sherwari	9096507459	Avanishenwari15@gmail.com	
4.	Tannu S. Korde	7841984450	kordeTanner133@gmail.com	
5.	Kimaya N. Kale	8866073792	kimyakele030@gmail.com	
6.	Shruhti Patekar	7387067403	shruhtipatekar@gmail.com	
7.	Vaishnavi Pradhan	8763169560	Pradhanshrutichauhan@gmail.com	
8.	Kritika T. Diwe	9284237798	diwekritika26@gmail.com	
9.	Prachi Laxkar	8806246119	Prachilaxkar15@gmail.com	
10.	Archita A. Maske	997503415	maskearchita@gmail.com	

Signature of:

Programme In-charge

ICAC Coordinator
CO ORDINATOR
INTERNAL QUALITY ASSURANCE CELL
DHARAMPETH, M. P. DEO MEMORIAL &
SCIENCE COLLEGE, NAGPUR

Principal
PRINCIPAL
Dharampeth M.P. Deo Memorial
Science College, Nagpur-440033



NEP Activity Report

Date: 27/02/2023

Name of Organizing Department or Committee: Chemistry

Name of the activity: NEP Activity (SEM II -PAPER-I-UNIT-4)-ACTIVITY-2

Suggested CRITERION point if any: Criteria -II

Date of Activity: 24/02/2023

Place of Activity: Chemistry Department

Name of Guest Speaker/s or Judge/s or Chief Guest/s if any: Nil

Title of the Activity: IDENTIFY LPG, CNG AND LNG USED IN INDIA

Number of Participants: 66

Name of the Teacher In-charge / Convener - Dr Tanishq Chaudhari

Names of other Committee Members / Staff:- Dr. V.P. Meshram

OUTCOME of the Activity with respect to mission vision of the institute and or academics:

Students came to know the uses of *LPG in refrigeration, agriculture and industrial sectors.

Also at home in power cooking equipment and heating appliances.

*CNG is used in automobiles as a substitute for gasoline.

*LNG is used for heavy duty equipment, gas valves, machinery and infrastructure.

Activity with newspaper coverage if any: Nil

Activity data save in PC of: Department of Chemistry

Note: Kindly share geotag photographs separately along with report on igacdsc2022@gmail.com



Prof. Pitambar Humane
IQAC Coordinator

CO ORDINATOR
INTERNAL QUALITY ASSURANCE CELL
DHARAMPETH, M. P. DEO MEMORIAL &
SCIENCE COLLEGE, NAGPUR

Dr. Tanishq Chaudhari
Name & Signature of Teacher In-charge

Dr. Akhilesh Peshwe
Principal

PRINCIPAL
Dharampeth M.P. Deo Memorial
Science College, Nagpur-440033

27/02/2023.

BSc - Sem-II ; 2022-2023.



DHARAMPETH M. P. DEO MEMORIAL SCIENCE COLLEGE,
North Ambazari Road, Near Ambazari Lake, Nagpur- 440033

DATA VALIDATION & VERIFICATION (DVV)

Name of the Programme

(PAPER-1) (UNIT-4)
SEM-II ; ACTIVITY-2 "Identify LPG, CNG, LNG used in India"

Date of the Programme

24/02/2023

Name of Chief Guest if any

Name of Guest Speaker if any

Sr. No.	Name of the Participant	Mobile Number	E-mail Id	Signature
1	Ruchi P. Dwivedi	8080776893	Ruchidwivedi23@gmail.com	
2	Ritika R. Bhojwar	98959385587087	RitikaBhojwar22@gmail.com	
3	Pratibha B. Bhosani	7821048413	pbbhosani712@gmail.com	
4	Shivam U. Patel	7038889083	sp040263@gmail.com	
5	Ankit R. Patel	9970905638	ankitpatel797275@gmail.com	
6	Saurabh S. Chaudhary	9359883501	schaudhary5599@gmail.com	
7	Monika I. Patel	7499225468	monikapatel7038@gmail.com	
8	Shital O. Patle	9764596337	shitalpatle12@gmail.com	
9	Samyak Hadke	7020171304	Samyakhadke@gmail.com	
10	Peeyushu Paul	9322725233	Peeyushupaul56@gmail.com	

Signature of:

Programme In-charge

IQAC Coordinator

CO ORDINATOR

INTERNAL QUALITY ASSURANCE CELL
DHARAMPETH M. P. DEO MEMORIAL &
SCIENCE COLLEGE, NAGPUR

Principal

PRINCIPAL

Dharampeth M. P. Deo Memorial
Science College, Nagpur-440033



DHARAMPETH M. P. DEO MEMORIAL SCIENCE COLLEGE,
North Ambazari Road, Near Ambazari Lake, Nagpur-440033

DATA VALIDATION & VERIFICATION (DVV)

11	Ruchi P. Dwivedi	8080776893	Ruchidwivedi230@gmail.com
12	Ritika R. Bhojari	9385587087	Ritikabhoyari224@gmail.com
13	shreya G. Bhimte	9637762811	shreyabhimtear@gmail.com
14	Ashwini R. Chaudhary	9699792732	chaudharyashwini@gmail.com
15	Khineshwarai R. Pushptode	8624976072	khineshwaraipushptode@gmail.com
16	Vaishali M. Sahawce	7977925403	Vaishalisahawce221@gmail.com
17	Tanu T. Dhaswale	8459543857	Tanudhaswale7@gmail.com
18	Yachang K. Pandey	9156035297	pandeyknsr@gmail.com
19	Anvay Borkar	9168538616	anvayborkar19@gmail.com
20	Aishha Pandey	8605231330	abhisheca@5251550@gmail.com
21	Peeyanshu Raut	9327725233	Peeyanshu Raut 56@gmail.com
22	Nitu B. Rai	7058638984	n.nitu1419@gmail.com
23	Abhay P. Tembhare	8975363145	abhay230102@gmail.com
24	Khushi K. Rewade	9588445994	Khushikrewade@gmail.com
25	Chiranjiv S. Gajbhaye	8329412694	Gajbhaye17@gmail.com

Signature of:

Tanishq

Programme In-charge

(Signature)

IQAC Coordinator

INTERNAL QUALITY ASSURANCE CELL
DHARAMPETH, M. P. DEO MEMORIAL &
SCIENCE COLLEGE, NAGPUR

(Signature)
Principal

Dharampeth M.P. Deo Memorial
Science College, Nagpur-440033



DHARAMPETH M. P. DEO MEMORIAL SCIENCE COLLEGE,
North Ambazari Road, Near Ambazari Lake, Nagpur-440033

DATA VALIDATION & VERIFICATION (DVV)

Name of the Programme : NEP - ACTIVITY-2
Date of the Programme : _____
Name of Chief Guest if any : _____
Name of Guest Speaker if any : _____

Sr. No.	Name of the Participant	Mobile Number	E-mail Id	Signature
24	Ravindra Khadse	8080851619	khadseravindra9892@gmail.com	
25	Aparna Mohare	7020649887	aparnamohare23@gmail.com	
28	Apeksha Kotangle	7559455794	apekshakotangle29@gmail.com	
29	Komalika chaudhary	9322033866	komalika.chaudhary073@gmail.com	
30	Vaishnavi Dange	9800758085	vaishnavidange02@gmail.com	
31	Anvay Borkar	8007198273	anvayborkar023@gmail.com	
32	Aishul Kirnapure	8577305321	aishulkirnapure113@gmail.com	
33	Priyanshi Raut	9322725233	priyanshiraut5@gmail.com	
34	Yogita Dange	7058437240	yogitadange@gmail.com	
35	Asya Dhoke	9011681628	asyadhoke1331@gmail.com	

Signature of:
Tanishq
Programme In-charge

CO-ORDINATOR

INTERNAL QUALITY ASSURANCE CELL
DHARAMPETH, M. P. DEO MEMORIAL &
SCIENCE COLLEGE, NAGPUR

Principal

Dharampeth M.P. Deo Memorial
Science College, Nagpur-440033



DHARAMPETH M. P. DEO MEMORIAL SCIENCE COLLEGE,
North Ambazari Road, Near Ambazari Lake, Nagpur- 440033

DATA VALIDATION & VERIFICATION (DVV)

36	Chanchal Waghwani	7796016894	waghwani taru@gmail.com <u>Waghwani</u>
37	Chiranjiv S. Gajbhiye	8829412694	Gajbhiye17@gmail.com <u>Gajbhiye</u>
38	Meenal .A. Chaudhary	8529014604	Meenalchaudhary2009@gmail.com <u>Chaudhary, Meenal</u>
39	Khineshwari R. Pushptode	8624976072	khineshwari pushptode@gmail.com <u>Khineshwari</u>
40	Shreya G. Bhimte	9637762811	shreyabhimte@gmail.com <u>Shreya</u>
41	Ashwini .R. Chaudhary	9699792732	chaudharyashwini287@gmail.com <u>A.R. Chaudhary</u>
42	Vaishali .M. Sahcore	7972925603	Vaishalisahcore251@gmail.com <u>Vaishali</u>
43	Yachana K. Pandey	9186035297	pandeykn54@gmail.com <u>Pandey</u>
44	Taru T. Dheewale	8459548857	tarudheewale2@gmail.com <u>Dheewale</u>
45	Kalyani R. Sindram	8446539622	Sindramkalyani@gmail.com <u>K.R. Sindram</u>
46	Aakansha Y. Mairal	8010923662	Aakanshamairal@gmail.com <u>A.Y. Mairal</u>
47	Neha L. Wanjari	9373832266	nehawanjari133@gmail.com <u>N.Wanjari</u>
48	Lucky A Vishwakarma	9579660186	lvishwakarma29@gmail.com <u>Vishwakarma</u>
49	Pranjali L. Meshram	7888080054	pranjali meshram55@gmail.com <u>P.L. Meshram</u>
50	Priya Sharma	80170764549	priya19012004sharma@gmail.com <u>Sharma</u>
51	Sejal Kolhe	8483045985	kolhesejal04@gmail.com <u>Kolhe</u>

Signature of:

Taru T. Dheewale
Programme In-charge

[Signature]
IQAC Coordinator

INTERNAL QUALITY ASSURANCE CELL
DHARAMPETH M. P. DEO MEMORIAL &
SCIENCE COLLEGE, NAGPUR

[Signature]
Principal

Dharampeth M.P. Deo Memorial
Science College, Nagpur-440033



DHARAMPETH M. P. DEO MEMORIAL SCIENCE COLLEGE,
North Ambazari Road, Near Ambazari Lake, Nagpur-440033

DATA VALIDATION & VERIFICATION (DVV)

52	Aakansha .k. Khobragade	7972228707	aakanshakhobragade70@gmail.com	Aakansha
53	Nihal v. Meshram	8767792900	nihaimeshram20@gmail.com	Nihal
54	Sudaj Mishra	9730639023	Sudajmishra251104@gmail.com	Sudaj
55	Munali D. Bhilkar	9322727616	munalibhilkar@gmail.com	Munali
56	Gurjan J. Bhojrao	7666799586	gurjanbhojrao@gmail.com	Gurjan
57	Aaliya Hussain	70661411118	hussainaaliya504@gmail.com	Aaliya
58	Amisha Ankana	766655917	amishaankana786@gmail.com	Amisha
59	Aakansha Khobragade	7271329451	aakanshakhobragade20@gmail.com	Aakansha
60	Kashi Satpute	9141486993	kashisatpute77@gmail.com	Kashi
61	Siddhi Tiwari	8087143696	siddhitiwari21@gmail.com	Siddhi
62	Vaideni Thute	7558499191	vaidenithute27@gmail.com	Vaideni
63	Ritika Sondliya	9125981655	ritikasondliya@gmail.com	Ritika
64	Umang G. Warthi	9322428500	umangwarthi@gmail.com	Umang
65	Muskan Kulkarni	9156889339	Muskankulkarni@gmail.com	Muskan
66	Kartika Deshmukh	9694720969	Kartikamel20@gmail.com	Kartika

Signature of:

Programme In-charge

IQAC Coordinator

COORDINATOR

INTERNAL QUALITY ASSURANCE CELL
DHARAMPETH, M. P. DEO MEMORIAL &
SCIENCE COLLEGE, NAGPUR

Principal

PRINCIPAL

Dharampeth M.P. Deo Memorial
Science College, Nagpur-440033



DHARAMPETH M. P. DEO MEMORIAL SCIENCE COLLEGE, NAGPUR
INTERNAL QUALITY ASSURANCE CELL (IQAC)

Activity Report

Date: 25.02.2023

Name of Organizing Department or Committee: Dept. of Home Science

Name of the activity: Discussion on overuse of antibiotics and antibiotic resistance. (NEP 2022 Activity)

Suggested CRITERION point if any:

Date of Activity: 25.02.2023

Place of Activity: Classroom, Dept. of Home Science

Name of Guest Speaker/s or Judge/s or Chief Guest/s if any:

Title of the Activity: Discussion on overuse of antibiotics and antibiotic resistance.

Number of Participants: 09

Name of the Teacher In-charge / Convener: Mrs. Meghna Pandit

Names of other Committee Members / Staff:

OUTCOME of the Activity with respect to mission vision of the institute and or academics:

To develop understanding of overuse and misuse of antibiotics and the effect of antibiotic resistance on individual's health and healthcare system.

Activity with newspaper coverage if any:

Activity data save in PC of: _____

Note: Kindly share geotag photographs separately along with report on iqacdsc2022@gmail.com

Prof. Pitambar Humane
IQAC COORDINATOR
INTERNAL QUALITY ASSURANCE CELL
DHARAMPETH, M. P. DEO MEMORIAL &
SCIENCE COLLEGE, NAGPUR

Name & Signature of Teacher In-charge
(Mrs. Meghna Pandit)

Dr. Akhilesh Peshwe
Principal

Dharampeth M.P. Deo Memorial
Science College, Nagpur-440033





DHARAMPETH M. P. DEO MEMORIAL SCIENCE COLLEGE,
North Ambazari Road, Near Ambazari Lake, Nagpur- 440033

DATA VALIDATION & VERIFICATION (DVV)

Name of the Programme : Discussion on overuse of antibiotics and antibiotic resistance
Date of the Programme : 25/09/2023
Name of Chief Guest if any : _____
Name of Guest Speaker if any : _____

Sr. No.	Name of the Participant	Mobile Number	E-mail Id	Signature
1.	Sushmita Mallick	9837916560	sushmitt60@gmail.com	<u>Sushmita</u>
2.	Aashi P. Ramteke	8983345716	aashiramteke@gmail	<u>Ramteke</u>
3.	Vaishnavi Ajay Upasak	9975287431	upasak.vishnavi@gmail	<u>Upasak</u>
4.	Renuka Raut	8855972285	kaushrenuka85@gmail	<u>Raut</u>
5.	Mahina Wankhede	7821883251	Mahinawankhede79@gmail.com	<u>Mahina</u>
6.	Meghna Mali	9067028112	Meghnamali18200@gmail.com	<u>Mali</u>
7.	Ananya A. Meghne	9284834639	ananyaMeghne@gmail.com	<u>Meghne</u>
8.	Vaishnavi Bahadure	9284679246	vaishnavi.bahadure.34@gmail.com	<u>Bahadure</u>
9.	Riya Shenkar	7249090278	shenkar.riya@gmail.com	<u>Shenkar</u>

Signature of:

Pandit
Programme-in-charge
(Alu Meghna Pandit)

[Signature]
IQAC Coordinator
CO ORDINATOR
INTERNAL QUALITY ASSURANCE CELL
DHARAMPETH, M. P. DEO MEMORIAL &
SCIENCE COLLEGE, NAGPUR

[Signature]
PRINCIPAL
Dharampeth M. P. Deo Memorial
Science College, Nagpur-440033



DHARAMPETH M. P. DEO MEMORIAL SCIENCE COLLEGE, NAGPUR
INTERNAL QUALITY ASSURANCE CELL (IQAC)

Activity Report

Date: 25.02.2023

Name of Organizing Department or Committee: Dept. of Home Science

Name of the activity: Discussion on vaccines other than those on Routine Immunization schedule. (NEP 2022 Activity)

Suggested CRITERION point if any:

Date of Activity: 25.02.2023

Place of Activity: Classroom, Dept. of Home Science

Name of Guest Speaker/s or Judge/s or Chief Guest/s if any:

Title of the Activity: Discussion on vaccines other than those on Routine Immunization schedule.

Number of Participants: 09

Name of the Teacher In-charge / Convener: Mrs. Meghna Pandit

Names of other Committee Members / Staff:

OUTCOME of the Activity with respect to mission vision of the institute and or academics:

To develop understanding of different vaccines and create awareness about vaccines other than those on Routine Immunization schedule.

Activity with newspaper coverage if any:

Activity data save in PC of: _____

Note: Kindly share geotag photographs separately along with report on iqaedsc2022@gmail.com

Prof. Pitambar Humane
IQAC Coordinator

COORDINATOR
INTERNAL QUALITY ASSURANCE CELL
DHARAMPETH, M. P. DEO MEMORIAL &
SCIENCE COLLEGE, NAGPUR

Name & Signature of Teacher In-charge
(Mrs. Meghna Pandit)

Dr. Akhilesh Peshwe
Principal

PRINCIPAL
Dharampeth M.P. Deo Memorial
Science College, Nagpur-440033





DHARAMPETH M. P. DEO MEMORIAL SCIENCE COLLEGE,
North Ambazari Road, Near Ambazari Lake, Nagpur- 440033

DATA VALIDATION & VERIFICATION (DVV)

Name of the Programme : Discussion on vaccines other than Routine Immunization Schedule
Date of the Programme : 25.02.2023
Name of Chief Guest if any : _____
Name of Guest Speaker if any : _____

Sr. No.	Name of the Participant	Mobile Number	E-mail Id	Signature
1.	Sushmita Mallick	9337916560	sushmita1760@gmail.com	<u>Sushmita</u>
2.	Aashi P. Ramteke	8983345716	ashiramteke7@gmail.	<u>Ramteke</u>
3.	Vaishnavi Ajay Upasak	9975287491	upasakvaishnavi@gmail	<u>Vaishnavi</u>
4.	Renuka Raut	8855972285	Renukaur85@gmail.com	<u>Raut</u>
5.	Makima Wankhede	7821883251	Makimawankhede7@gmail.com	<u>Makima</u>
6.	Mayuri Mali	9061028172	Mayurimali2003@gmail.com	<u>Mali</u>
7.	Ananya A. Meghre	9284834439	ananya.meghre@gmail.com	<u>Meghre</u>
8.	Vaishnavi Bahadure	9284679244	Vaishnavibahadure34@gmail.com	<u>Bahadure</u>
9.	Riya P. Sherkar	7249070278	sherkarriya@gmail.com	<u>Sherkar</u>

Signature of:

Mandit
Programme In-charge

(Mrs. Meghna Pandit)

[Signature]
COORDINATOR
WILSON ASSURANCE CELL
DHARAMPETH, M. P. DEO MEMORIAL &
SCIENCE COLLEGE, NAGPUR

[Signature]
PRINCIPAL
Dharampeth M.P. Deo Memorial
Science College, Nagpur-440032



DHARAMPETH M. P. DEO MEMORIAL SCIENCE COLLEGE, NAGPUR
INTERNAL QUALITY ASSURANCE CELL (IQAC)
Activity Report (2022-23)

Date: 28/02/2023

Name of Organizing Department or Committee: Department of Physics in association with Statistics, Mathematics, Computer Science and Electronics.

Name of the activity: Visit to Exhibition organised by Atomic Minerals Directorate for Exploration and Research, Nagpur

Suggested CRITERION point if any: 5.3

Date of Activity: 28-02-2023

Place of Activity: Atomic Minerals Directorate for Exploration and Research, Civil Lines, Nagpur

Name of Guest Speaker/s or Judge/s or Chief Guest/s if any: Scientists from the Directorate

Title of the Activity: Visit to Exhibition organised by Atomic Minerals Directorate for Exploration and Research

Number of Participants: 36

Name of the Teacher In-charge / Convener: Lt. Dr. Prashant Ambekar

Names of other Committee Members / Staff: Dr. Varsha Rangari, Mr. Dilip Choudhari and Mr. Shriram Paunekar

OUTCOME of the Activity with respect to mission vision of the institute and or academics:

The Atomic Minerals Directorate for Exploration and Research has invited for the exhibition specially organised for students. The personnel from the said department have visited the college and handed over invitation on discussion with the staff members on 14-02-2023. Around 92 students responded for the call. But on the date of visit day 32 students from various departments participated the visit.

The visit was related to various principles and methods for exploring the atomic minerals and detection of any hazardous material. The said institute has also organised a quiz competition for the students apart from the visit to exhibition and museum containing different types of ores. Students were very happy and enlightened with the scientific knowledge by the scientist of the firm imparted in them.

Activity with newspaper coverage if any: NA

Activity data save in PC of: Lt. Dr. P. W. Ambekar



Prof. Pitambar Humane
IQAC Coordinator

CO ORDINATOR
INTERNAL QUALITY ASSURANCE CELL
DHARAMPETH, M. P. DEO MEMORIAL &
SCIENCE COLLEGE, NAGPUR

HEAD
Lt. Dr. DEPARTMENT OF PHYSICS
Parashram Ambekar
Name & Signature of Teacher in charge
Dharampeth M. P. Deo Memorial
Science College, Nagpur

Dr. Akhilesh Peshwe
Principal
PRINCIPAL
Dharampeth M. P. Deo Memorial
Science College, Nagpur.



DHARAMPETH M. P. DEO MEMORIAL SCIENCE COLLEGE,
North Ambazari Road, Near Ambazari Lake, Nagpur- 440033

DATA VALIDATION & VERIFICATION (DVV)

Name of the Programme : Visit to Atomic Minerals Directorate for Exploration and Research Nagpur
Date of the Programme : 28-02-2023
Name of Chief Guest if any : _____
Name of Guest Speaker if any : _____

Sr. No.	Name of the Participant	Mobile Number	E-mail Id	Signature
1	Addya Mishra	7218424186	adityamishra3933@gmail.com	
2	Jay A Patil	7385436956	jay.patil0326@gmail.com	
3	Jasraj D. Patilwal	9390820325	jasrajpatil41@gmail.com	
4	Prachit R. Kotpallikar	7498102097	prachitkotpallikar@gmail.com	
5	Janvi A. Katarokar	7888116270	janvikatarokar@gmail.com	
6	Aasmin K. Sheikh	8668322568	aasmin3029@gmail.com	
7	Nupur M. Sharma	8222042269	nupursharma25@gmail.com	
8	Tushar S. Wadhwa	9038980231	anjaliwadhwae@gmail.com	
9	Anjali N. Chavde	8261964188	anjalicavde20@gmail.com	
10	Sakshi S. Gisi	9529660277	sakshigisi24@gmail.com	

Signature of _____

HEAD
DEPARTMENT OF PHYSICS
Dharampeth M. P. Deo Memorial
Science College, Nagpur

CO ORDINATOR
INTERNAL QUALITY ASSURANCE CELL
DHARAMPETH, M. P. DEO MEMORIAL &
SCIENCE COLLEGE, NAGPUR

PRINCIPAL
Dharampeth M. P. Deo Memorial
Science College, Nagpur



DHARAMPETH M. P. DEO MEMORIAL SCIENCE COLLEGE,
North Ambazari Road, Near Ambazari Lake, Nagpur- 440033

DATA VALIDATION & VERIFICATION (DVV)

11	Dolly B Gabbane	9284269236	dollygabbane7@gmail.com	Dabbane
12	Tanushree R. Date	9766977406	tanushree@gmail.com	Date
13	Prachi K Vasabhe	9325336932	Prachi@gmail.com	Vasabhe
14	Anushka. D. Das	7058933157	ad04092003@gmail.com	Das
15	Aditi Dhoble	8847709571	aditidhoble@gmail.com	Dhoble
16	Prachi Manusmare	9856969609	prachis0208@gmail.com	Manusmare
17	Sakshi Barapatre	8317219372	Sakshi2002hb@gmail.com	Barapatre
18	Vaibhav Rane	7744951383	vaibhavranee2207@gmail.com	Rane
19	Uday Kandarkar	9545897196	udaykandarkar@gmail.com	Kandarkar
20	Himanshu Lakhe	7448252469	harkhehimansh@gmail.com	Himanshu
21	Pratiksha Thakre	8459570299	pratikshathakre10@gmail.com	Thakre
22	Divyani Dhule	7030731921	divyanidhule@gmail.com	Dhule
23	Mithraj Chauhan	9420626335	Mithrajprajuchavhan1002@gmail.com	Chauhan
24	Anjali V. Rangankar	8830031253	anjali-rangankar40@gmail.com	Rangankar
25	Saurabh V. Rout	9527283213	Saurabhv.rout@gmail.com	Rout
26	Mahima R. Wankhede	7821883251	mahimawankhede7@gmail.com	Wankhede

Signature of:

HEAD
DEPARTMENT OF PHYSICS
Dharampeth M. P. Deo Memorial
Science College, Nagpur

CO ORDINATOR
INTERNAL QUALITY ASSURANCE CELL
DHARAMPETH, M. P. DEO MEMORIAL &
SCIENCE COLLEGE, NAGPUR

PRINCIPAL
Dharampeth M. P. Deo Memorial
Science College, Nagpur



DHARAMPETH M. P. DEO MEMORIAL SCIENCE COLLEGE, NAGPUR

INTERNAL QUALITY ASSURANCE CELL (IQAC)

Activity Report

Date: 28-02-2023

Name of Organizing Department or Committee: Department of Statistics.

Name of the activity: Computation of Crude Birth Rate.

Suggested CRITERION point if any:

Date of Activity: 28th February 2023.

Place of Activity: Statistics lab

Name of Guest Speaker/s or Judge/s or Chief Guest/s if any: N.A.

Title of the Activity: Computation of Crude Birth Rate.

Number of Participants: 08

Name of the Teacher: Gauri Sinekar

Names of other Committee Members / Staff: N.A.

OUTCOME of the Activity with respect to mission vision of the institute and or academics:

The data of age group and no. of births in different population of age group (in years) was given to the students. Students read and understood the question, revised the topic of crude birth rate and found out the result. Students gain the knowledge about how to analysed the data of crude birth rate.

Activity with newspaper coverage if any: No

Activity data save in PC of: Department of Statistics

Prof. Pitambar Humane
IQAC Coordinator

CO ORDINATOR
INTERNAL QUALITY ASSURANCE CELL
DHARAMPETH, M. P. DEO MEMORIAL &
SCIENCE COLLEGE, NAGPUR

G. Sinekar
Name & Signature of Teacher In-charge

Dr. Akhilesh Peshwe
Principal

PRINCIPAL
Dharampeth M. P. Deo Memorial
Science College, Nagpur.



DHARAMPETH M. P. DEO MEMORIAL SCIENCE COLLEGE, NAGPUR

INTERNAL QUALITY ASSURANCE CELL (IQAC)

Activity Report

Date: 28-02-2023

Name of Organizing Department or Committee: Department of Statistics.

Name of the activity: Sheppard's correction for moments for grouped data.

Suggested CRITERION point if any:

Date of Activity: 28 Feb 2023

Place of Activity: Statistics lab

Name of Guest Speaker/s or Judge/s or Chief Guest/s if any:

Title of the Activity: Sheppard's correction for moments for grouped data.

Number of Participants: 22

Name of the Teacher: Durga hingwe

Names of other Committee Members / Staff: N.A.

OUTCOME of the Activity with respect to mission vision of the institute and or academics: We assume in grouped data that the frequencies are concentrated in the middle part of the class interval. This assumption does not hold true in general and grouping error is introduced.

Activity with newspaper coverage if any: No

Activity data save in PC of: Department of Statistics

Prof. Pitambar Humane
IQAC Coordinator

CO-ORDINATOR
INTERNAL QUALITY ASSURANCE CELL
DHARAMPETH, M. P. DEO MEMORIAL
SCIENCE COLLEGE, NAGPUR

Name & Signature of Teacher In-charge

Dr. Akhilesh Peshwe
Principal

Dharampeth M.P. Deo Memorial
Science College, Nagpur.



DHARAMPETH M. P. DEO MEMORIAL SCIENCE COLLEGE NAGPUR

Department of Statistics

Class: B.Sc. Sem. - II

NEP ACTIVITY

Paper - II

Unit II

Name of the Teacher: Durga C. Hingwe

Date 28-02-23

Title of Activity: Sheppard's correction for moments for grouped data

Sr. No.	Name of Student	Batch	Mobile No.	Email ID	Signature
1	Rutika Yadav	F2	8446085943	yadavarutika77@gmail.com	<u>Rutika</u>
2	Vaishali Turkar	F2	8373650950	vaishaliturkar48@gmail.com	<u>Turkar</u>
3	Veena Borkar	SCOM	9322016921	veenaborkar19@gmail.com	<u>veena</u>
4	Megha S. Ballav	PSM	9421728880	meghaballav04@gmail.com	<u>Megha</u>
5	Pranali V. Gupta	SCOM	7020069377	25991531@gmail.com	<u>Gupta</u>
6	Divyani V. Zagade	SCOM	9022866318	divyanizagade@gmail.com	<u>Zagade</u>
7	Mudit Khirdkar	SCOM	805329357	muditkhirdkar@gmail.com	<u>Mudit</u>
8	Jarvis Kumbhar	SCOM	7058235243	jarviskumbhar@gmail.com	<u>Kumbhar</u>
9	Prachi T. Punde	SCOM	8010362282	prachitpunde9142@gmail.com	<u>Prachi</u>
10	Utkarsha Ingale	SCOM	7489159178	utkarshaingale9@gmail.com	<u>Utkarsha</u>
11	Sania Niwal	SCOM	7058425021	nishakosarkar333@gmail.com	<u>Niwal</u>
12	Nisha Kosarkar	SCOM	7058425021	nishakosarkar333@gmail.com	<u>Nisha</u>
13	Sakshi Mishra	SCOM	8529889815	smishra89683@gmail.com	<u>Sakshi</u>
14	Jashika Deshpande	SCOM	9130091540	jashikadeshpande21@gmail.com	<u>Jashika</u>
15	Jahvi Joge	F2	7385060871	janhvijoge08@gmail.com	<u>Jahvi</u>
16	Jagruti Fulkar	F2	8767911307	jaagrutifulkar@gmail.com	<u>Jagruti</u>
17	Jarvi Khode	F2	7385066634	jarvikhode892@gmail.com	<u>Jarvi</u>
18	Devasthi Karkade	F2	9021344285	karkedevasthi@gmail.com	<u>Devasthi</u>
19	Jarvi Laibet	F2	8446510539	jarvitaibet@gmail.com	<u>Jarvi</u>
20	Pranali Dehankar	F2	8767581278	pdehna@gmail.com	<u>Pranali</u>
21	Nayan N. Walthare	F1	7941870947	nayanwalthare@gmail.com	<u>Nayan</u>
22	Vidya Lohi	F2	97020963219	vidyalohi8@gmail.com	<u>Vidya</u>

D. Hingwe
Signature of Teacher

D. Hingwe
Teacher in charge



DHARAMPETH M. P. DEO MEMORIAL SCIENCE COLLEGE, NAGPUR
INTERNAL QUALITY ASSURANCE CELL (IQAC)
NEP Activity Report

Date:03/03/2023

Name of Organizing Department or Committee: Chemistry
Name of the activity: NEP Activity Report (Sem IV, paper II, Unit III)
Suggested CRITERION point if any: Criteria II
Date of Activity: 28/02/2023
Place of Activity: Department of Chemistry
Name of Guest Speaker/s or Judge/s or Chief Guest/s if any- Nil
Title of the Activity: Applications of Molecular Spectroscopy
Number of Participants: 70
Name of the Teacher In-charge / Convener: Dr. Mrs. Mrudul R. Keskar
Names of other Committee Members / Staff: Dr. Mrs. V. P. Meshram

OUTCOME of the Activity with respect to mission vision of the institute and or academics: This is a student's centric activity. Molecular spectroscopy is the measurement of interactions between electromagnetic waves and matter. Students got ideal about the different applications of molecular Spectroscopy such as determining the atomic structure of a sample, to investigate the structure, surface properties, thermodynamics of inorganic, biological and polymeric systems etc.



Activity with newspaper coverage if any: Nil
Activity data saved in PC of: Chemistry Department

Name & Signature of Teacher In-charge
(Dr. Mrs. Mrudul R. Keskar)



Prof. Pitambar Humane
IQAC Coordinator
CO ORDINATOR
INTERNAL QUALITY ASSURANCE CELL
DHARAMPETH, M. P. DEO MEMORIAL &
SCIENCE COLLEGE, NAGPUR

Dr. Akhilesh Peshwe
Principal
PRINCIPAL
Dharampeth M.P. Deo Memorial
Science College, Nagpur-440033



DHARAMPETH M. P. DEO MEMORIAL SCIENCE COLLEGE,
North Ambazari Road, Near Ambazari Lake, Nagpur- 440033

DATA VALIDATION & VERIFICATION (DVV)

Name of the Programme

NEP Activity - Applications of Spectroscopy (Sem IV, Paper II, Unit III)

Date of the Programme

28-02-2023

Name of Chief Guest if any

-

Name of Guest Speaker if any

-

Sr. No.	Name of the Participant	Mobile Number	E-mail Id	Signature
1.	Ankita Manoj Mishra	8421293176	mishraankita4683@gmail.com	Ankita
2.	Amrita Chavhan	7382005732	CSmitaChavhan@gmail.com	Amrita
3.	Vaishnavi Kapse	8983751089	vaishnavikapse05@gmail.com	Vaishnavi
4.	Sucati Longadje	8390516517	SucatiLongadje@gmail.com	Sucati
5.	Ketaki Kulkarni	9912759066	KetakiKulkarni13@gmail.com	Ketaki
6.	Anushree Chandel	9145631751	Anushree246@gmail.com	Anushree
7.	Smriti Vaidya	8856908764	SmritiVaidya@gmail.com	Smriti
8.	Ajuna Sherkh	8080083981	Ajuna@sherkh@gmail.com	Ajuna
9.	Gauri Gaute	9767873447	GauriGaute@gmail.com	Gauri
10.	Prachi Meshram	7028735508	PrachiMeshram@gmail.com	Prachi
11.	Devesh Longadje	9326246453	DeveshLongadje@gmail.com	Devesh
12.	Kalyani C. Shahare	9307046378	ShahareKalyani5@gmail.com	Kalyani
13.	Vaibhav A. Mahapatra	8767838219	VaibhavMahapatra03@gmail.com	Vaibhav
14.	Anchal S. Singh	7875537925	Sardesh Singh2332@gmail.com	Anchal Singh

Signature of: 
Programme in-charge

COORDINATOR
ICAC COORDINATOR
DHARAMPETH M. P. DEO MEMORIAL & SCIENCE COLLEGE, NAGPUR

Dharampeth M.P. Deo Memorial Science College, Nagpur-440033



DHARAMPETH M. P. DEO MEMORIAL SCIENCE COLLEGE,
North Ambazari Road, Near Ambazari Lake, Nagpur- 440033

DATA VALIDATION & VERIFICATION (DVV)

15	Nikita S. Bhave	7820812749	nikitabhav98@gmail.com	N. Bhave
16	Pratiksha S. Naughare	8623033760	Pratikshanavgare@gmail.com	P.S. Naughare
17	Shital G. Bankar	7758055139	shitalbankar8122@gmail.com	S. G. Bankar
18	Samir P. Ghumde	9359236713	sameerghumde02@gmail.com	S. Ghumde
19	Aniket V. Kulkade	7741945323	Akulkade09@gmail.com	A. Kulkade
20	Shital R. Kelkar	9373389729	shital200kk@gmail.com	@kelkar
21	Aranya Motghure	7219218955	Aranyamotghure1807@gmail.com	@Aranya
22	Bhumnika Thakre	7218247917	BhumnikaThakre@gmail.com	Bhumnika
23	Apurva Venulkar	9623613911	Apurva.Venulkar.com	A. Venulkar
24	Vishakha Basuante	8329639839	VishakhaBasuante@gmail.com	V. Basuante
25	Chhakuli Y. Wadkar	9325047907	chhakuliwadkar@gmail.com	@Wadkar
26	Shyamal D. Narze	9765943998	shyamalnarze@gmail.com	S. Narze
27	Vaishnavi R. Lakhe	8669594869	chhakuliLakhe05@gmail.com	V. Lakhe
28	Tina G. Rahangdale	9921776169	Hnarahangdale@gmail.com	@Rahangdale
29	Juhi S. Chaudhari	8669248944	chaudharijuhi12@gmail.com	Juhi

Signature of:

Programme In-charge

IQAC Coordinator
CO ORDINATOR
INTERNAL QUALITY ASSURANCE CELL
DHARAMPETH, M. P. DEO MEMORIAL &

Principal
PRINCIPAL
Dharampeth M. P. Deo Memorial
Science College, Nagpur-440033



DHARAMPETH M. P. DEO MEMORIAL SCIENCE COLLEGE,
North Ambazari Road, Near Ambazari Lake, Nagpur- 440033

DATA VALIDATION & VERIFICATION (DVV)

30	Mansi. I. Mule	8468891807	mansi1982@gmail.com	Mansi
31	Sakshi S. Meshram	9145355733	Sakshimeshram210@gmail.com	Sakshi
32	Jagauti D. Workar	7447366022	jagautiworkar09@gmail.com	Jagauti
33	Smruti Vaidya	8856908764	SmrutiVaidya36@gmail.com	Smruti
34	Anushree Chandel	9145631751	Anuchandel2001@gmail.com	Anushree
35	Prachal Meshram	7028735508	prachalmeshram@gmail.com	Prachal
36	Afrina Sheikh	8080083981	afrinashikh973@gmail.com	Afrina
37	Gauri Raut	9161873447	arukaur2003@gmail.com	Gauri
38	Ketaki Karpal	9112759066	KetakiKarpal@gmail.com	Ketaki
39	Muskan Yadav	9579492617	muskan.yadav1211	Muskan
40	Sagar S. Bawane	9975460979	Sagarbawane627@gmail.com	Sagar
41	Chirayu B. Dolas	8010135012	chirayudolas22@gmail.com	Chirayu
42	Sejal R. Lakharpal	9028851568	SejalLakharpal@gmail.com	Sejal
43	Kajal P. Nighat	9373250629	Kajalnighat2000@gmail.com	Kajal
44	Sania Midhat Kaya	8975726700	midhatsania@gmail.com	Sania

Signature of:

Programme In-charge

IQAC Coordinator
CO-ORDINATOR
INTERNAL QUALITY ASSURANCE CELL
DHARAMPETH, M. P. DEO MEMORIAL &
SCIENCE COLLEGE, NAGPUR

Principal
PRINCIPAL
Dharampeth M. P. Deo Memorial
Science College, Nagpur-440033



DHARAMPETH M. P. DEO MEMORIAL SCIENCE COLLEGE,
North Ambazari Road, Near Ambazari Lake, Nagpur-440033

DATA VALIDATION & VERIFICATION (DVV)

45.	Jyoti sharma	8669736380	jyoti8290@gmail.com	Jyoti
46.	Aman Dongre	7709211212	amanadongre@gmail.com	Aman
47.	Darshana madari	8830146516	darshana.madari@gmail.com	Darshan
48.	Vaishnavi Bedade	8657188093	vaishnavibedade100@gmail.com	Vaish
49.	Ornila Bondre	9370072867	bondreornila@gmail.com	Ornila
50.	Shravya Bhawale	8888266004	shravyabhawale24@gmail.com	Shravya
51.	Vaibhav shende	8050660286	vaibhavshende97@gmail.com	Vaibhav
52.	Rupesh Bhakre	8805887370	Rupeshbhakre12@gmail.com	Rupesh
53.	Niket Thakre	7378399087	Niketthakre12@gmail.com	Niket
54.	Siddhant Harkare	8879092931	sidhant.harkare@gmail.com	Sidd.
55.	Kalpna Suhagpure	9179236712	kalpnasuhagpure7@gmail.com	Kalpna
56.	Ritika M. Varma	9356764224	ritika29@gmail.com	Ritika
57.	Rutika V. Gajbhaye	7670826960		Rutika
58.	Shashank Pande		shanku@gmail.com	Shanku
59.	Jasraj Paliwal	9320820325		Jasraj
60.	Harsh Kodape	9606671622	harsh.kodape008@gmail.com	Harsh
61.	Veishnavi Gadge	9022976649	gadgelveishnavi@gmail.com	Veish
62.	Poojwal Bhoyar	8010434334	poojwal8738@gmail.com	Pooj
63.	Aditya Deulkar	9028915706		aditya-
64.	Nikita Borapake			Nikita
65.	Gaurav Langa	7767854017		Gaurav

Signature of:

Programme In-charge

CO-ORDINATOR
INTERNAL QUALITY ASSURANCE CELL
DHARAMPETH, M. P. DEO MEMORIAL &
SCIENCE COLLEGE, NAGPUR

Principal
PRINCIPAL

Dharampeth M.P. Deo Memorial
Science College, Nagpur-440033



DHARAMPETH M. P. DEO MEMORIAL SCIENCE COLLEGE, NAGPUR

INTERNAL QUALITY ASSURANCE CELL (IQAC)

NEP Activity Report

Date:01/03/2023

Name of Organizing Department or Committee: Chemistry

Name of the activity: NEP Activity Report (Sem II, paper II, Unit III-Nuclear Chemistry)

Suggested CRITERION point if any: Criteria II

Date of Activity: 28-02-2023

Place of Activity: Department of Chemistry Classroom

Name of Guest Speaker/s or Judge/s or Chief Guest/s if any- Nil

Title of the Activity: Study of Nuclear power points in India

Number of Participants: 59

Name of the Teacher In-charge / Convener: Dr. Mrs. Yogita Morey (Dahire)

Names of other Committee Members / Staff: Dr. Mrs. V. P. Meshram

OUTCOME of the Activity with respect to mission vision of the institute and or academics:

This is students's centric activity. Model making for study of nuclear power plant in India helps students to understand the idea about nuclear chemistry. This model visually clears the concept of students about the nuclear power plants.



Activity with newspaper coverage if any: Nil

Activity data saved in PC of: Chemistry Department

Note: Kindly share Jio tag photographs separately along with report on igacdsc2022@gmail.com

Prof. Pitambar Humane

IQAC Coordinator

CO ORDINATOR

INTERNAL QUALITY ASSURANCE CELL

DHARAMPETH M. P. DEO MEMORIAL &

SCIENCE COLLEGE, NAGPUR

Dr. Yogita Morey Dahire
Name & Signature of Teacher In-charge

Dr. Akhilesh Peshwe
Principal

PRINCIPAL

Dharampeth M.P. Deo Memorial
Science College, Nagpur-440033



DHARAMPETH M. P. DEO MEMORIAL SCIENCE COLLEGE,
North Ambazari Road, Near Ambazari Lake, Nagpur- 440033

DATA VALIDATION & VERIFICATION (DVV)

Name of the Programme

NEP Activity 3, Unit III (Sem II) (Nuclear Chemistry)

Date of the Programme

: Study of Nuclear Power Point

Name of Chief Guest if any

: - Date 28-02-2023

Name of Guest Speaker if any

: -

Sr. No.	Name of the Participant	Mobile Number	E-mail Id	Signature
1.	Komalika S. Chaudhari	9322033866	KomalikaChaudhari673@gmail.com	
2.	Anjali R. Thakre	7066554821	AnjaliThakre@gmail.com	
3.	Peanali Y. Chavhare	9699654562	peanaliChavhare09@gmail.com	
4.	Apeksha D. Kotangale	7559455794	apeksha.kotangale2@gmail.com	
5.	Lucky A Vishwakarma	9579660186	lvishwakarma@200gmail.com	
6.	Priya Sharma	8010764549	priya.sharma@gmail.com	
7.	Nisha Pandey	8605231390	nishapandey@gmail.com	
8.	Yashraj Pandey	9156035527	yashrajpandey@gmail.com	
9.	Vishal W. Tonge	8421657943	VishalTonge2001@gmail.com	
10.	Riya A. Singh	9595649831	Riyaas2307@gmail.com	
11.	Shreya A. Jha	8983236002	Sangeetajha@0303gmail.com	
12.	Aakansha Maitral	8010923662	aakanshamaitral@gmail.com	
13.	Khushi Rewade	9588445994	KhushiRewade@gmail.com	
14.	Chanchal K. Waghwan	7796016894	waghwanitara@gmail.com	

Signature of:

Programme In-charge

Dr. Yogita Morey (Dahire)

IQAC Coordinator

INTERNAL QUALITY ASSURANCE CELL
DHARAMPETH M. P. DEO MEMORIAL &
SCIENCE COLLEGE, NAGPUR

Principal

Dharampeth M.P. Deo Memorial
Science College, Nagpur-440033



DHARAMPETH M. P. DEO MEMORIAL SCIENCE COLLEGE,
North Ambazari Road, Near Ambazari Lake, Nagpur-440033

DATA VALIDATION & VERIFICATION (DVV)

15	Yogita K. Thakore	9878611024443	yogitathakore2384@gmail.com	YKThakore
16.	Dhanashri Newam	9359909913	DhanashriNewam78@gmail.com	Dhanashri
17	Kuntika Pokale	9021553341	pokalekuntika@gmail.com	Kpokale
18	Nikhil Kumare	8999040961	nikhilkumare@gmail.com	Nikhil
19	Pawan thakre	8262969713	thakrePawan@gmail.com	Pawan
20	Gunjan Bhojare	7666799586	gunjanbhojare@gmail.com	Gunjan
21	Ashiya husain	9359259741	Ashiyahusain@gmail.com	Ashiya
21	Amisha Arakara	7666559171	AmishaArakara@gmail.com	Amisha
22)	Akansha Khobragad	7972728707	AkanshaKhobragad@gmail.com	Akansha
23)	Ghanakree Dhanore	7774900320	GhanakreeDhanore@gmail.com	Ghanakree
24)	Kalyani Sircham	8446539622	K.SirchamKalyani@gmail.com	K.Sircham
25)	Gauri Bhojare	8668335576	GauriBhojare@gmail.com	Aymeraj
26)	Dhanashree Neware	9359909913	DhanashreeNeware@gmail.com	Aymeraj
27)	Anvay Borkar	9168538614	AnvayBorkar19@gmail.com	Aymeraj
28)	Divya Tagde	7350090176	DivyaTagdes68@gmail.com	Divya
29)	Abhay R. Tembhare	8975383145	abhay230620@gmail.com	Abhay
30)	Nitu Rai	7658638984	niturai1419@gmail.com	Nitu
31)	Anshul Y. Kisanpore	9284067169	anshulkisanpore65@gmail.com	Anshul
32)	Yogita R. Denge	7058437240	yogitadenge@gmail.com	YDenge
33)	Ravindra Khudse	8007198273	Ravindrakhudse@gmail.com	RKhudse
34)	Aparna Mahare	7020649887	aparnamahare@gmail.com	Aparna

Signature of
Programme in-charge

Dr. Yogita Morey (Dahore)

IQAC Coordinator
CO ORDINATOR
INTERNAL QUALITY ASSURANCE CELL
DHARAMPETH M. P. DEO MEMORIAL
SCIENCE COLLEGE, NAGPUR

Principal
PRINCIPAL
Dharampeth M.P. Deo Memorial
Science College, Nagpur-440033



DHARAMPETH M. P. DEO MEMORIAL SCIENCE COLLEGE,
North Ambazari Road, Near Ambazari Lake, Nagpur-440033

DATA VALIDATION & VERIFICATION (DVV)

85)	Azaya Dhoke	9011681628	azayadhoke@gmail.com	Azaya
26)	Neha L. Wanjari	9873832266	nehawanjari353@gmail.com	Neha
33)	Maunali L. Bhilke	9322727616	maunali3511cas@gmail.com	Maunali
38)	Shauli Chinnekar	2320953263	shaulichinnekar@gmail.com	Shauli
39)	Nilesh V. Meshram	8767792960	nileshmeshram26@gmail.com	Nilesh
40)	Vaideni P Thote	7558499191	vaidenithote27@gmail.com	Vaideni
41)	Umang Warthi	9322428500	umanguwarthi19@gmail.com	Umang
42)	Ritika Sandhiya	9175581655	ritikasandhiya27@gmail.com	Ritika
43)	Kastika Deshmukh	9699720960	kastikadeshmukh@gmail.com	Kastika
44)	Monika I. Patel	749825468	MonikaIpatel203@gmail.com	Monika
45)	Shital O. Patle	9764596837	S-P12@gmail.com	Shital
46)	Prityanshu Pant	9322725233	prityanshupant@gmail.com	Prityanshu
47)	Pranjal L Meshram	7888080054	pranjalimeshram85@gmail.com	P.L. Meshram
48)	Ankit Patel	9970905638	ankitpatel197275@gmail.com	Ankit
49)	Siddhi Tiwari	8087143696	siddhitiwari21@gmail.com	Siddhi
50)	Muskan Kulkarni	9156889239	muskankulkarni15@gmail.com	Muskan
51)	Ashalesha Khadgi	7820929579	Ashaleshakhadgi@gmail.com	Ashalesha
52)	Sunaina Chichonde	8530970132	Sunainachichonde@gmail.com	Sunaina
53)	Ashwini R. Chaudhary	9699792732	chaudharyashwini287@gmail.com	A.R. Chaudhary
54)	Vaishali M. Sahare	7972925403	Vaishalisahare251@gmail.com	Vaishali
55)	Khineshwar R. Pushptode	8624976672	khineshwaripushptode@gmail.com	Kh.

Signature of:
Programme In-charge

Dr. Yogita Morey (Dahire)

Signature of:
IQAC Coordinator

INTERNAL QUALITY ASSURANCE CELL
DHARAMPETH, M. P. DEO MEMORIAL &
SCIENCE COLLEGE, NAGPUR

Signature of:
Principal

Dharampeth-M.P. Deo Memorial
Science College, Nagpur-440033



DHARAMPETH M. P. DEO MEMORIAL SCIENCE COLLEGE, NAGPUR
INTERNAL QUALITY ASSURANCE CELL (IQAC)

Activity Report

Date: 01.03.2023

Name of Organizing Department or Committee: Dept. of Home Science

Name of the activity: Quiz on Immunity (NEP 2022 Activity)

Suggested CRITERION point if any:

Date of Activity: 01.03.2023

Place of Activity: Classroom, Dept. of Home Science

Name of Guest Speaker/s or Judge/s or Chief Guest/s if any:

Title of the Activity: Quiz on Immunity

Number of Participants: 09

Name of the Teacher In-charge / Convener: Mrs. Meghna Pandit

Names of other Committee Members / Staff:

OUTCOME of the Activity with respect to mission vision of the institute and or academics:

To develop understanding of different aspects of immunity.

Activity with newspaper coverage if any:

Activity data save in PC of: _____

Note: Kindly share geotag photographs separately along with report on iqaedsc2022@gmail.com

Prof. Pitambar Humane

IQAC Coordinator

CO-ORDINATOR
INTERNAL QUALITY ASSURANCE CELL
DHARAMPETH, M. P. DEO MEMORIAL &
SCIENCE COLLEGE, NAGPUR

Name & Signature of Teacher In-charge

(Mrs. Meghna Pandit)

Dr. Akhilesh Peshwe

Principal

Dharampeth M. P. Deo Memorial
Science College, Nagpur-440033





DHARAMPETH M. P. DEO MEMORIAL SCIENCE COLLEGE,
North Ambazari Road, Near Ambazari Lake, Nagpur- 440033

DATA VALIDATION & VERIFICATION (DVV)

Name of the Programme : Day on Immunity
Date of the Programme : 01/03/2023
Name of Chief Guest if any : _____
Name of Guest Speaker if any : _____

Sr. No.	Name of the Participant	Mobile Number	E-mail Id	Signature
1.	Sushmita Mallick	9837916560	sushmita760@gmail.com	<u>Sushmita</u>
2.	Aashi P. Ramteke	8983345716	aashiramteke7@gmail.com	<u>Ramteke</u>
3.	Vaishnavi Ajay Upasak	9975287431	upasakvaishnavi@gmail.com	<u>Upasak</u>
4.	Renuka Raut	8855972285	Renukaraut85@gmail.com	<u>Raut</u>
5.	Nahina Wankhede	7821883251	Nahinawankhede7@gmail.com	<u>Nahina</u>
6.	Mayuri Mali	9061028112	Mayurimali1202@gmail.com	<u>Mali</u>
7.	Ananya A. Meghri	9284834639	ananya.meghri@gmail.com	<u>Meghri</u>
8.	Vaishnavi Bahadure	9286679244	vaishnavibahadure34@gmail.com	<u>Bahadure</u>
9.	Riya Sherkar	7249070278	sherkarouriya@gmail.com	<u>Bhargava</u>

Signature of:

Meghna Pandit
Programme in-charge

(Mrs. Meghna Pandit)

[Signature]
IQAC Coordinator
CO ORDINATOR
INTERNAL QUALITY ASSURANCE CELL
DHARAMPETH, M. P. DEO MEMORIAL &
SCIENCE COLLEGE, NAGPUR

[Signature]
Principal
Dharampeth M. P. Deo Memorial
Science College, Nagpur-440033



DHARAMPETH M. P. DEO MEMORIAL SCIENCE COLLEGE, NAGPUR
INTERNAL QUALITY ASSURANCE CELL (IQAC)

Activity Report

Date: 2/3/2023

Name of Organizing Department or Committee: Chemistry

Name of the activity: B. Sc Sem VI Paper I Unit -II

Suggested CRITERION point if any: Criteria I, II

Date of Activity: 1/03/2023

Place of Activity: Chemistry Laboratory

Name of Guest Speaker/s or Judge/s or Chief Guest/s if any:

Title of the Activity: Demonstration and its Composition of Fe(III) – SSA complex

Number of Participants: 55

Name of the Teacher In-charge / Convener: Dr. Vaishali P. Meshram

Names of other Committee Members / Staff: Dr Deepika Brijpuria

OUTCOME of the Activity with respect to mission vision of the institute and or academics:

The absorbance of the different stoichiometric ration of Fe³⁺ and salicylic acid at a selected wavelength is determined. The maximum absorbance of the solution of the stoichiometric ratio reveals the empirical formula of the complex as the maximum amount of coloured complex is formed, The colour of Complex was found to be violet in colour

Activity with newspaper coverage if any: Nil

Activity data save in PC of: Chemistry

Note: Kindly share geotag photographs separately along with report on igacdsc2022@gmail.com



Prof. Pitambar Humane
IQAC Coordinator

CO ORDINATOR
INTERNAL QUALITY ASSURANCE CELL
DHARAMPETH, M. P. DEO MEMORIAL &
SCIENCE COLLEGE, NAGPUR

Dr. Vaishali P. Meshram
Name & Signature of Teacher In-charge

Dr. Akhilesh Peshwe
Principal

PRINCIPAL
Dharampeth M.P. Deo Memorial
Science College, Nagpur-440033



DHARAMPETH M. P. DEO MEMORIAL SCIENCE COLLEGE,
North Ambazari Road, Near Ambazari Lake, Nagpur- 440033

DATA VALIDATION & VERIFICATION (DVV)

Name of the Programme : Demonstration and its composition of Fe(III)-SSA complex
 Date of the Programme : 1/03/2023
 Name of Chief Guest if any : _____
 Name of Guest Speaker if any : _____

Sr. No.	Name of the Participant	Mobile Number	E-mail Id	Signature
1	Vanshika. G. Yede	7558244609	vanshikayede@gmail.com	<u>Vanshika</u>
2	Kartik Adlakha	8530597159	k-adlakha@gmail.com	<u>Adlakha</u>
3	Chetan Kamthe	9637271601	Kamthuchetan6@gmail.com	<u>Chetan</u>
4	Neha R. Khawase	8766738340	nehar.002kk@gmail.com	<u>Neha</u>
5	Dolly B. Gabhane	9284264236	dolygabhane7@gmail.com	<u>Dolly</u>
6	Anjali. R. Mishra	8319948106	am98654@gmail.com	<u>Anjali</u>
7	Supriya Patle	7757871925	PatleSupriya@gmail.com	<u>Patle</u>
8	Prachi K. Vasaabhe	9325336932	Prachi Vasaabhe@gmail.com	<u>Vasaabhe</u>
9	Sakshi. V. Chaurate	7709204933	chauratesakshi24@gmail.com	<u>Sakshi</u>
10	Laxmi G. Sayam	7517793675	SayamLaxmi384@gmail.com	<u>Laxmi</u>

Signature of:

[Signature]

Programme In-charge

[Signature]
IQAC Coordinator

INTERNAL QUALITY ASSURANCE CELL
DHARAMPETH, M. P. DEO MEMORIAL &
SCIENCE COLLEGE, NAGPUR

[Signature]
Principal

PRINCIPAL

Dharampeth M. P. Deo Memorial
Science College, Nagpur-440033



DHARAMPETH M. P. DEO MEMORIAL SCIENCE COLLEGE,
North Ambazari Road, Near Ambazari Lake, Nagpur- 440033

DATA VALIDATION & VERIFICATION (DVV)

11	Damini M. Bhandbuche	8275105785	bhandbuchedamini@gmail.com	D. Bhandbuche
12	Tejal A. Mankar	9322458697	tejalmanekar93@gmail.com	Tejal
13	Tanmay Bhute	7697250831	tanmaybhute90@gmail.com	Tanmay
14	Sonam Upgade	9890230462	upgradesonam@gmail.com	Sonam Upgade
15	Sukhila Puroti	7507439390	SukhilaPuroti22@gmail.com	Sukhila Puroti
16	Rakhi. P. Gedam	7378312509	gedamrakhi2002@gmail.com	Rakhi Gedam
17	Neha. A. Waghade	7249895144	nehawaghade16082002@gmail.com	Neha Waghade
18	Pratibha L. Gujjar	9579263881	pratibhagujjar2006@gmail.com	Pratibha
19	Amisha R. Ande	8767618394	amulo166@gmail.com	Amisha
20	Jayashree D. Hiwale	7385473157	Juhihiwale10@gmail.com	J. D. Hiwale
21	Akasha. S. Bhute	9556964121	akashas2020@gmail.com	A. Bhute
22	Amit. T. Walde	9168496253	amitwalde44edivya@gmail.com	Amit
23	Nitin L. Harinkhede	9561179324	harinkhedevijay@gmail.com	Nitin
24	Asha. S. Landge	930223181	ashalandge00@gmail.com	Asha. S. Landge
25	Suraj Sheude	9356666487	Surajshende2019@gmail.com	Suraj Sheude
26	Megha Fulwar	8805399608	meghafulwar@gmail.com	Megha Fulwar

Signature of:

Programme In-charge

IQAC Coordinator

CO ORDINATOR
INTERNAL QUALITY ASSURANCE CELL
DHARAMPETH M. P. DEO MEMORIAL &
SCIENCE COLLEGE, NAGPUR

Principal
PRINCIPAL

Dharampeth M.P. Deo Memorial
Science College, Nagpur-440033



DHARAMPETH M. P. DEO MEMORIAL SCIENCE COLLEGE,
North Ambazari Road, Near Ambazari Lake, Nagpur- 440033

DATA VALIDATION & VERIFICATION (DVV)

27	Aspita. T. Dakhale	8010866758	aspitadakhale2@gmail.com	Dakhale
28	Mrunali R. Songare	9850163812	Songaremrnuni16@gmail.com	Songare
29	Prathum Pramkumar Gupta	967275949	prathumgupta.197@gmail.com	Gupta
30	Kaustabh R. Ramteke	9218487719	ramtekekkaustabh200@gmail.com	Ramteke
31	Anshuman Sharma	9370892462	anshuman.sharma.8510@gmail.com	Anshuman
32	Vishal Kumar Singh	9610187223	singhvishal.1902@gmail.com	Vishal
33	Anushri S. Wele	8530778433	anushriwele@gmail.com	Anushri
34	Anjali R. Patil	7498102109	anjaliPatil@gmail.com	Anjali
35	Akanksha R Yeluce	8767935524	akankshayeluce@gmail.com	Akanksha
36	Pallavi Y. Bhagat	9022654940	Pallavin2208@gmail.com	Bhagat
37	Raji. N. Pathan	8669555198	Rajitkhan5006@gmail.com	Rajan
38	Rani D. Patil	788824794	ranipatil68091@gmail.com	Rani
39	Anushka S. Das	7058933157	ad0409200@gmail.com	Anushka
40	Chaitali M. Bumbade	9359540394	chaitali2020@gmail.com	Chaitali
41	Raksha D. Dhale	7498511875	rakshadhal03@gmail.com	Dhale
42	Priyanshi Singh	7219259020	priyanshisingh19010@gmail.com	Singh

Signature of:

Programme In-charge

IQAC Coordinator
CO ORDINATOR
INTERNAL QUALITY ASSURANCE CELL
DHARAMPETH, M. P. DEO MEMORIAL &
SCIENCE COLLEGE, NAGPUR

Principal
PRINCIPAL
Dharampeth M.P. Deo Memorial
Science College, Nagpur-440033



DHARAMPETH M. P. DEO MEMORIAL SCIENCE COLLEGE,
North Ambazari Road, Near Ambazari Lake, Nagpur- 440033

DATA VALIDATION & VERIFICATION (DVV)

43	Nandini P. Pounikar	9764359642	nandnupounika@gmail.com	Nandini
44	Manohar S. Gode	9370329854	manohargode79@gmail.com	Manohar
45	Sakshi Moon	774582736	sakshim3030@gmail.com	Moon
46	Shivani G. Bhute	9302500209	bhuteshivani@gmail.com	Bhute
47	Kavitha S. Bamsed	7389812607	kavithambamsed40@gmail.com	Kavitha
48	Manali S. Shinde	7249637434	manalishinde062@gmail.com	Manali
49	Aishwarya A. Joshi	7498328662	aishwaryajoshi003@gmail.com	Joshi
50	Shruti M. Pawar	9527988707	shrutipawar1001@gmail.com	Pawar
51	Shikha S. Thakre	800907069	shikhatkree@gmail.com	Shikha
52	Laxmi M. Gode	7758058514	laxmigoode2001@gmail.com	Laxmi
53	Nandini S. Hodge	9370301679	nandinihodge12@gmail.com	Hodge
54	Bhargavi A. Sambar	7709403806	bhargavisambar05@gmail.com	Sambar
55	Tanvi W. Chaudhari	860010234	chaudhari8600@gmail.com	Chaudhari

Signature of:

Programme In-charge

IQAC Coordinator
CO ORDINATOR
INTERNAL QUALITY ASSURANCE CELL
DHARAMPETH, M. P. DEO MEMORIAL &
SCIENCE COLLEGE, NAGPUR

Principal
PRINCIPAL
Dharampeth M.P. Deo Memorial
Science College, Nagpur-440033



Activity Report

Date: 2/03/2023

Name of Organizing Department or Committee: Department of Microbiology

Name of the activity: Game match the column on microbial interaction.

Suggested CRITERION point if any: II and V

Date of Activity: 2/03/2023

Place of Activity: Department of Microbiology Dharampeth MP Deo Memorial Science College, Nagpur

Name of Guest Speaker/s or Judge/s or Chief Guest/s if any: Nil

Title of the Activity: Game match the column on microbial interaction on Paper I- unit IV for semester II students.

Number of Participants: 29

Name of the Teacher In-charge / Convener: Dr. Pratiksha V. Pohekar

Names of other Committee Members / Staff:

OUTCOME of the Activity with respect to mission vision of the institute and or academics:

- This game are designed to promote, a fun way to study and in the process help improve students' knowledge.
- Students can do critical thinking, and get into a habit of innovative learning.
- It promotes a healthy debate amongst students in order to learn from each other, and aiding in the team building process



Name & Signature of Teacher In-charge
Dr. Pratiksha V. Pohekar

Prof. Pitambar Humane

CO-ORDINATOR
IQAC Coordinator
DHARAMPETH, M. P. DEO MEMORIAL &
SCIENCE COLLEGE, NAGPUR

Dr. V. R. Kalthoke
Head

HOD
Deptt. of Microbiology,
Dharampeth MP Deo Memorial
Science College, Nagpur

Dr. Akhilesh Peshwe

Principal

Principal
Dharampeth M. P. Deo Memorial
Science College, Nagpur



DHARAMPETH M. P. DEO MEMORIAL SCIENCE COLLEGE,
North Ambazari Road, Near Ambazari Lake, Nagpur- 440033

DATA VALIDATION & VERIFICATION (DVV)

Name of the Programme : Game Match the column on microbial interaction
Date of the Programme : 2/03/23 (SEM I Students)
Name of Chief Guest if any : _____
Name of Guest Speaker if any : _____

Sr. No.	Name of the Participant	Mobile Number	E-mail Id	Signature
1)	Munika Kulkarni	9156889239	MunikaKulkarni34@gmail.com	
2)	Umang G. Wasthi	9322428500	Umangwasthi@gmail.com	
3)	Ashdhi B. Tiwari	8087143696	ashdhitiwari@gmail.com	
4)	Kartika M. Deshmukh	9694720460	Kartika.mdes@gmail.com	
5)	Vaidhi P. Thate	7558499191	VaidhiThate2@gmail.com	
6)	Ritika R. Sordliya	9175581655	ritikasordliya@gmail.com	
7)	Yogita R. Denge	7058437260	Yogitadenge@gmail.com	
8)	Nisha Pande	8605231390	abhishek8605231390@gmail.com	
9)	Pravanshu Raut	9322725233	pravanshuraud56@gmail.com	
10)	Arav Borkar	9168538644	aravborkar@gmail.com	

Signature of:

Programme In-charge

IQAC Coordinator

Principal

Dharampeth M. P. Deo Memorial
Science College, Nagpur



DATA VALIDATION & VERIFICATION (DVV)

11)	Shravya. A. jha	8983236002	Sangeetajha0303@gmail.com	4/19
12)	Bally. K. Wanjari	9326013213	Ksridhanwanjari12345@gmail.com	Bally
13)	Riya. A. Singh	9595649831	riyaas2307@gmail.com	Rsingh
14)	Kuntika Pokale	9021533341	pokalekuntika6@gmail.com	Kpokale
15)	Chanchal. K. Waghware	7796016894	waghwaretaxa@gmail.com	Chanchal
16)	Aakansha Y mairal	8010923662	aakanshamairal@gmail.com	Ay mairal
17)	Neha I. Wanjari	9333832266	nehawanjari@gmail.com	Neha
18)	Parnali Chavhare	969699654562	parnalichavhare@gmail.com	P
19)	Pratiksha Meshram	8459070338	pratikshameshram@gmail.com	PM
20)	Nitu B. Rai	7052638984	onitub1419@gmail.com	N
21)	Ravindra Khadse	8007198273	khadseravindra342@gmail.com	R.A.
22)	Chiranjiv. S. Gaibhiye	8329412894	Gaibhiye17@gmail.com	Gaibhiye
23)	Khushi. K. Rewade	9588445994	khushirewade@gmail.com	Rewade
25)	Geetai Bhoyar	8668335876	gunjanbhoyar234@gmail.com	Geetai
26)	Asya D hobe	901681628	aryanamratal331@gmail.com	Asya

Signature of:

Shreeraj
Programme In-charge

[Signature]
COORDINATOR
INTERNAL QUALITY ASSURANCE CELL
DHARAMPETH, M. P. DEO MEMORIAL
SCIENCE COLLEGE, NAGPUR

Principal
Dharampeth M. P. Deo Memorial
Science College, Nagpur



DATA VALIDATION & VERIFICATION (DVV)

27)	Anjali Meshram	7767905772	anjali.meshram2023@gmail.com	Anjali
28)	Neenal Choudhary	9529014604	neenalchoudhary2004@gmail.com	Neenal Choudhary
29)	Sonali G. Choudhary	8856055003	sonalichoudhary19@gmail.com	Sonali Choudhary

Signature of:

Ankur
Programme In-charge

[Signature]

IQAC Coordinator
CO ORDINATOR
INTERNAL QUALITY ASSURANCE CELL
DHARAMPETH, M. P. DEO MEMORIAL &

Principal
DHARAMPETH
Dharampeth M. P. Deo Memorial
Science College Nagpur



DHARAMPETH M. P. DEO MEMORIAL SCIENCE COLLEGE, NAGPUR
INTERNAL QUALITY ASSURANCE CELL (IQAC)

Date: 03/03/2023

Name of Organizing Department/ Committee: Home Science Department

Name of the activity: Demo on manure preparation from kitchen waste

Suggested CRITERION point if any: Criterion II

Date of Activity: 03/03/2023

Place of Activity: Home Science Department

Name of Guest Speaker/s or Judge/s or Chief Guest/s if any:

Title of the Activity: manure preparation

Number of Participants: 11.

Name of the Teacher In-charge/Convener: Ms. Ankita Wankhede.

Names of other Committee Members/Staff: Mrs. Manju Deshpande

OUTCOME of the Activity with respect to mission vision of the institute and or academics:

1. Learning about manure preparation at home provides students with practical hand-on experience. It allow them to apply the theoretical knowledge they acquire in the classroom to reel-world situation.
2. This workshop aims to educate students about the various techniques associated with manure preparation.
3. They learn how to implement techniques in their home and contribute to household waste management.

Activity with newspaper coverage if any:

Activity data save in PC of:



Prof. Pitambar Humane
IQAC **COORDINATOR**
INTERNAL QUALITY ASSURANCE CELL
DHARAMPETH, M. P. DEO MEMORIAL &
SCIENCE COLLEGE, NAGPUR

Name & Signature of Teacher In-charge

Dr. Akhilesh Peshwe
PRINCIPAL
Dharampeth M. P. Deo Memorial
Science College, Nagpur.



DHARAMPETH M. P. DEO MEMORIAL SCIENCE COLLEGE,
North Ambazari Road, Near Ambazari Lake, Nagpur- 440033

Sem IV

DATA VALIDATION & VERIFICATION (DVV)

1	Ojaswi Wankhede	8767699751	wankhedeojaswi@gmail.com	Ojaswi
2	Kimaya N. Kale	8866073792	kimayakale003@gmail.com	Kimaya
3	Ashant G. Sheswai	9096507459	ashantsheswai@gmail.com	Ashant
4	Tamne G. Korde	7841984450	kordeTamne13@gmail.com	Tamne
5	Shrushti Patkar	7387067403	shrushtipatkar@gmail.com	Shrushti
6	Vaishnavi Pradhan	9763169560	pradhanvaishnavi155@gmail.com	Vaish
7	Pallavi Katre	8459277408	pkatre523@gmail.com	Pallavi
8	Bhagyashree Ambule	9359139065	ambuleb667@gmail.com	Ambule
9	Pragya S. Tiwari	6394098386	pragyatiwari19052004@gmail.com	Pragya
10	Prachi N. Londkar	8806244419	prachilondkar159@gmail.com	Prachi
11	Priya K. Khawshi	9763617224	priyakhawshi3@gmail.com	Priya

Signature of

Shubha

Programme in-charge

COORDINATOR
INTERNAL QUALITY ASSURANCE CELL
DHARAMPETH, M. P. DEO MEMORIAL &
SOMBA COLLEGE, NAGPUR

PRINCIPAL
Dharampeth M. P. Deo Memorial
Science College, Nagpur.



DHARAMPETH M. P. DEO MEMORIAL SCIENCE COLLEGE, NAGPUR
INTERNAL QUALITY ASSURANCE CELL (IQAC)

Activity Report (NEP: 2022-23)

Date: 29/3/23

Name of Organizing Department or Committee: Zoology

Name of the activity: To study ultra structure of nuclear membrane by making model.

Suggested CRITERION point if any: Criteria I

Date of Activity: 04/03/2023

Place of Activity: Class room 09

Name of Guest Speaker judge/s or Chief Guest/s if any:

Title of the Activity: To study ultra structure of nuclear membrane by making model.

Number of Participants: 08

Name of the Teacher In-charge / Convener: Dr. Kishor T. Waghmare

Names of other Committee Members / Staff:

OUTCOME of the Activity with respect to mission vision of the institute and or academics:

- 1) Students actively participated in this activity and understand structure of nuclear membrane
- 2) This activity helps student in generating and develop more ideas about topic as per their imagination.
- 3) Students become more creative and prepare model which reflect their level of understanding.

Activity with newspaper coverage if any: NIL

Activity data save in PC of: Zoology Department/personal laptop



(Handwritten signature of Prof. Pitambar Humane)

Prof. Pitambar Humane
IQAC Coordinator

(Handwritten signature of Dr. Kishor T. Waghmare)
Name & Signature of Teacher In-charge

(Handwritten signature of Dr. Arhilesh Peshwe)

Dr. Arhilesh Peshwe
Principal
Principal
Dharampeth M. P. Deo Memorial
Science College, NAGPUR.



DHARAMPETH M. P. DEO MEMORIAL SCIENCE COLLEGE,
North Ambazari Road, Near Ambazari Lake, Nagpur- 440033

DATA VALIDATION & VERIFICATION (DVV)

Name of the Programme : To study ultra structure of nuclear membrane by making model.
Date of the Programme : 04/03/2023
Name of Chief Guest if any : _____
Name of Guest Speaker if any : _____

Sr. No.	Name of the Participant	Mobile Number	E-mail Id	Signature
1.	Umang G. Wauthi	9322428500	umangwauthi@gmail.com	
2.	Muskan Kulkarni	9156889239	muskankulkarni34@gmail.com	
3.	Kartika Deshmukh	9699720960	Kartikaamd20@gmail.com	
4.	Ritika R. Sondhiya	9175581655	Ritikar Sondhiya@gmail.com	
5.	Vaidehi P. Thote	7558499191	vaidehitthote27@gmail.com	
6.	Chanchal K. Waghwan	7796016894	waghwanitara@gmail.com	
7.	Aakansha Y. mairal	8010923662	aakanshimairal@gmail.com	
8.	Dhanashri Neware	9359909913	Dhanashrineware786@gmail.com	
9.				
10.				
11.				
12.				
13.				
14.				

Signature of:
Programme In-charge

IQAC Coordinator

Principal
Dharampeth M. P. Deo Memorial
Science College, NAGPUR.



DHARAMPETH M. P. DEO MEMORIAL SCIENCE COLLEGE, NAGPUR
INTERNAL QUALITY ASSURANCE CELL (IQAC)

NEP Activity Report

Date: 28/3/23

Name of Organizing Department or Committee: Department of Chemistry

Name of the activity: NEP Activity B.Sc. Home Science Sem IV Unit 2

Suggested CRITERION point if any: Criteria II

Date of Activity: 4/3/2022

Place of Activity: Home Science Department 2nd floor

Name of Guest Speaker/s or Judge/s or Chief Guest/s if any: Nil

Title of the Activity: Preparation Azo dye.

Number of Participants: 10

Name of the Teacher In-charge / Convener: Dr. Sandip Madhukar Bhiwagade

Names of other Committee Members / Staff: Dr. Vaishali P. Meshram

OUTCOME of the Activity with respect to mission vision of the institute and or academics:

This is student centric activity. This activity helps to understand students how azo dye prepared in the laboratory. What is mean by temperature sensitive reaction. How little change in temperature effect the product or completely destroyed the product in the reaction, how dye is applied on the cloth, what precaution should be taken during dyeing process, what is the chemistry behind the Azo dye Formation.

Activity with newspaper coverage if any : Nil

Activity data save in PC of: Department of Chemistry



(Dr. Sandip Bhiwagade

Name & Signature of Teacher In-charge



Prof. Pitambar Humane
IQAC Coordinator



Dr. Akhilesh Peshwe
Principal

CO ORDINATOR
INTERNAL QUALITY ASSURANCE CELL
DHARAMPETH, M. P. DEO MEMORIAL &
SCIENCE COLLEGE, NAGPUR

PRINCIPAL
Dharampeth M.P. Deo Memorial
Science College, Nagpur-440033



DHARAMPETH M. P. DEO MEMORIAL SCIENCE COLLEGE,
North Ambazari Road, Near Ambazari Lake, Nagpur-440033

DATA VALIDATION & VERIFICATION (DVV)

Name of the Programme : Preparation of azo dye
Date of the Programme : 4/3/2023
Name of Chief Guest if any : _____
Name of Guest Speaker if any : _____

Sr. No.	Name of the Participant	Mobile Number	E-mail Id	Signature
1	Avani Shenwai	9096507459	avanishenwai15@gmail.com	
2	Qiasvi Wankhede	8767699751	wankhedeqiasvi@gmail.com	
3	Pragya Tiwari	6394098386	Pragyatiwari14052003@gmail.com	
4	Kimaya Kale	8866043492	KimayaKale@gmail.com	
5	Tannu Korde	7841984450	korditannu113@gmail.com	
6	Pranali Ghongadkar	9309079627	Pranali02gh@gmail.com	
7	Bhagyashree Ambule	9359139068	ambuleb67@gmail.com	
8	Sujata Kaurse	9175451202	SujataKaurse1@gmail.com	
9	Pallavi B. Katre	8459217408	pkatre573@gmail.com	
10	Roohi N. Laxkar	8806260419	Roohilaxkar159@gmail.com	

Signature of:

Programme In-charge

IQAC Coordinator

INTERNAL QUALITY ASSURANCE CELL
DHARAMPETH, M. P. DEO MEMORIAL &
SCIENCE COLLEGE, NAGPUR

Principal
PRINCIPAL

Dharampeth M.P. Deo Memorial
Science College, Nagpur-440033



DHARAMPETH M. P. DEO MEMORIAL SCIENCE COLLEGE, NAGPUR

INTERNAL QUALITY ASSURANCE CELL (IQAC)

NEP Activity Report

Date : 28/3/23

Name of Organizing Department or Committee: Department of Chemistry

Name of the activity: NEP Activity Home Science Sem II Unit I

Suggested CRITERION point if any: Criteria II

Date of Activity: 4/3/23

Place of Activity: Home Science department 2nd floor

Name of Guest Speaker/s or Judge/s or Chief Guest/s if any: Nil

Title of the Activity: Precaution while using LPG

Number of Participants: 8

Name of the Teacher In-charge / Convener: Dr. Sandip Madhukar Bhiwagade

Names of other Committee Members / Staff: Dr. Vaishali P. Meshram

OUTCOME of the Activity with respect to mission vision of the institute and or academics:

This activity helps to understand students what are the precaution should be taken during the use of LPG gas cylinder in kitchen as well as in laboratory. What is the common mistake one did while using LPG which leads to the accident in household

Activity with newspaper coverage if any : Nil

Activity data save in PC of: Department of Chemistry



Dr. Sandip Bhiwagade

SMB

Prof. Pitambar Humane

Prof. Pitambar Humane
IQAC Coordinator

CO ORDINATOR
INTERNAL QUALITY ASSURANCE CELL
DHARAMPETH, M. P. DEO MEMORIAL &
SCIENCE COLLEGE, NAGPUR

Name & Signature of Teacher In-charge

Dr. Akhilesh Peshwe
Principal

PRINCIPAL
Dharampeth M.P. Deo Memorial
Science College, Nagpur-440037



DHARAMPETH M. P. DEO MEMORIAL SCIENCE COLLEGE,
North Ambazari Road, Near Ambazari Lake, Nagpur- 440033

DATA VALIDATION & VERIFICATION (DVV)

Name of the Programme : Precaution while using LPG
Date of the Programme : 4/3/2023
Name of Chief Guest if any : _____
Name of Guest Speaker if any : _____

Sr. No.	Name of the Participant	Mobile Number	E-mail Id	Signature
1.	Aditi R. Vaidya	9075714531	aditivaidya619@gmail.com	
2.	Ashwini N. Pandey	8308621012	ashwinipandey229@gmail.com	
3.	Neha L. Sursaut	9057167848	nehalsursaut@gmail.com	
4.	SAKSHI R. CHAKONDE	7843018801	sakshichakonde@gmail.com	
5.	Neha R. Vishwakarma	8983534173	nehavishwakarma85485@gmail.com	
6.	shalu patthi	8329115380	shalupatthi9@gmail.com	
7.	bhavona Gwendasari	8888437303	bhavonagwendasari@gmail.com	
8.	Minal L. patte	915807073a	patteminl83@gmail.com	

Signature of:

Programme In-charge

ICAC Coordinator

ICAC COORDINATOR
DHARAMPETH, M. P. DEO MEMORIAL &
SCIENCE COLLEGE, NAGPUR

Principal
PRINCIPAL

Dharampeth M.P. Deo Memorial
Science College, Nagpur-440033



DHARAMPETH M. P. DEO MEMORIAL SCIENCE COLLEGE, NAGPUR
INTERNAL QUALITY ASSURANCE CELL (IQAC)
NEP Activity Report

Date : 28/3/23

Name of Organizing Department or Committee: Department of Chemistry

Name of the activity: NEP Activity Home Science Sem II unit II

Suggested CRITERION point if any: Criteria II

Date of Activity: 4/3/2022

Place of Activity: Home Science Department 2nd floor

Name of Guest Speaker/s or Judge/s or Chief Guest/s if any: Nil

Title of the Activity: Use of pH paper to identify acid and base.

Number of Participants: 8

Name of the Teacher In-charge / Convener: Dr. Sandip Madhukar Bhiwagade

Names of other Committee Members / Staff: Dr. Vaishali P. Meshram

OUTCOME of the Activity with respect to mission vision of the institute and or academics:

This is student centric activity. In this activity students learn about different types of acids and bases with the help of pH paper. With the help of pH paper students are able to find out the range of pH different compounds which are use in kitchen like lemon etc.

Activity with newspaper coverage if any : Nil

Activity data save in PC of: Department of Chemistry



Dr. Sandip Bhiwagade

Name & Signature of Teacher In-charge

Prof. Pitambar Humane
IQAC Coordinator

CO ORDINATOR
INTERNAL QUALITY ASSURANCE CELL
DHARAMPETH, M. P. DEO MEMORIAL &
SCIENCE COLLEGE, NAGPUR

Dr. Akhilesh Peshwe
Principal

PRINCIPAL
Dharampeth M.P. Deo Memorial
Science College, Nagpur-440037



DHARAMPETH M. P. DEO MEMORIAL SCIENCE COLLEGE,
North Ambazari Road, Near Ambazari Lake, Nagpur- 440033

DATA VALIDATION & VERIFICATION (DVV)

Name of the Programme : Use of PH paper to identify acid & Bases
Date of the Programme : 4/3/2023
Name of Chief Guest if any : _____
Name of Guest Speaker if any : _____

Sr. No.	Name of the Participant	Mobile Number	E-mail Id	Signature
①	Minal. L. patle	9158070732	patleminal83@gmail.com	
②	SAKSHI. R. CHAKUNDE	7843018801	sakshichakunde@gmail.com	
③	Neha R. Vishwakarma	8985534173	nehavishwakarma8585@gmail.com	
④	Neha L. Suresh	9057161848	nehasuresh@pmail.com	
5.	Ashwini N. Pandey	8308621072	ashwinipandey@gmail.com	
6.	Aditi - R. Vaidya	9075714591	aditivaidya615@gmail.com	
7.	shalu pardihi	8329115380	shalupardihi@gmail.com	
8	bhavona Bhusabasani	8858637303	bhavanagrusabasani@gmail.com	

Signature of:

Programme In-charge

IQAC Coordinator

INTERNAL QUALITY ASSURANCE CELL
DHARAMPETH, M. P. DEO MEMORIAL &
SCIENCE COLLEGE, NAGPUR

Principal
PRINCIPAL

Dharampeth M.P. Deo Memorial
Science College, Nagpur-440033



DHARAMPETH M. P. DEO MEMORIAL SCIENCE COLLEGE, NAGPUR

INTERNAL QUALITY ASSURANCE CELL (IQAC)

NEP Activity Report

Date : 28/3/23

Name of Organizing Department or Committee: Department of Chemistry

Name of the activity: NEP Activity Sem VI Unit I

Suggested CRITERION point if any: Criteria II

Date of Activity: 4/3/2023.

Place of Activity: Room No. 9

Name of Guest Speaker/s or Judge/s or Chief Guest/s if any: Nil

Title of the Activity: NMR spectra of simple organic compound and its interpretation

Number of Participants: 51

Name of the Teacher In-charge / Convener: Dr. Sandip Madhukar Bhiwagade

Names of other Committee Members / Staff: Dr. Vaishali P. Meshram

OUTCOME of the Activity with respect to mission vision of the institute and or academics:

This is student centric activity. This activity helps to understand students very clearly how to interpretate the NMR spectra of simple organic molecule. This activity helps the students to clear the concepts of chemical shift, shielding and deshielding effect, coupling constant and all the other concept related to NMR.

Activity with newspaper coverage if any : Nil

Activity data save in PC of: Department of Chemistry



Dr. Sandip Bhiwagade

Name & Signature of Teacher In-charge

Prof. Pitambar Humane
IQAC Coordinator

CO ORDINATOR
INTERNAL QUALITY ASSURANCE CELL
DHARAMPETH, M. P. DEO MEMORIAL &
SCIENCE COLLEGE, NAGPUR

Dr. Akhilesh Peshwe
Principal

PRINCIPAL
Dharampeth M.P. Deo Memorial
Science College, Nagpur-440033



DHARAMPETH M. P. DEO MEMORIAL SCIENCE COLLEGE,
North Ambazari Road, Near Ambazari Lake, Nagpur- 440033

DATA VALIDATION & VERIFICATION (DVV)

Name of the Programme : NMR spectra of simple organic comp. & its interpretation
Date of the Programme : 4/3/2023
Name of Chief Guest If any : _____
Name of Guest Speaker If any : _____

Sr. No.	Name of the Participant	Mobile Number	E-mail Id	Signature
1.	Isha B. Gupta	9373259849	isha1202gupta@gmail.com	<u>Isha</u>
2.	Ankita R. Bhojat	8788031173	ankitabhoyaroc@gmail.com	<u>Ankita</u>
3.	Nandini P. Purnikar	9764359642	nandini.purnikar@gmail.com	<u>Nandini</u>
4.	Purnali N. Gaikwad	9130893362	gaikwadpurnali39@gmail.com	<u>Purnali</u>
5.	Ajashini Bhagat	7558367348	ajashinibhagat56@gmail.com	<u>Ajashini</u>
6.	Astha Lakharwade	9405197842	asthalakharwade@gmail.com	<u>Astha</u>
7.	Sonam Uprade	9890230462	upradesonam@gmail.com	<u>Sonam</u>
8.	Sushila Puri	7507439390	Sushilapuri22@gmail.com	<u>Puri</u>
9.	Neha Khawase	8766798340	neha2002k@gmail.com	<u>Neha</u>
10.	Asha S. Landge	9922291581	ashalandgeccol@gmail.com	<u>Asha</u>

Signature of:

Programme In-charge

ICG COORDINATOR

INTERNAL QUALITY ASSURANCE CELL
DHARAMPETH, M. P. DEO MEMORIAL &
SCIENCE COLLEGE, NAGPUR

Principal

PRINCIPAL

Dharampeth M. P. Deo Memorial
Science College, Nagpur-440033



DHARAMPETH M. P. DEO MEMORIAL SCIENCE COLLEGE,
North Ambazari Road, Near Ambazari Lake, Nagpur- 440033

DATA VALIDATION & VERIFICATION (DWV)

11	Sanket K. Lode	7972085380	sanketlode123@gmail.com	<u>Sanket</u>
12	Sunil S. Laxkar	8767435158	Sunilshyamburao82@gmail.com	<u>Sunil</u>
13	Harsh H. Waghmare	9112059406	Harshh.waghmare786@gmail.com	<u>Harsh</u>
14	Bhargavi A. Sambare	7709403806	blagavi.sambare@gmail.com	<u>Bl.</u>
15	Nandini S. Hodge	9370301673	nandinihodge17@gmail.com	<u>Nandini</u>
16	Laxmi M. Gorle	7752058514	laxmigorle29@gmail.com	<u>Laxmi Gorle</u>
17	Anushri S. Wale	8530778433	anushriwale@gmail.com	<u>Anushri</u>
18	Kavlik K. Adlakhia	8530597159	k.adlakhia@gmail.com	<u>Kavlik</u>
19	Madhura. Bondre	8767484914	Madhura.bondre@gmail.com	<u>Madhura</u>
20	Ayushi. Shukla	9373668043	ayushishukla38112002@gmail.com	<u>Ayushi</u>
21	Rinam Wankhede	8010966529	wankhederinam07@gmail.com	<u>Rinam</u>
22	Shivani diwadri	8855900546	Shivani.diwadi@gmail.com	<u>Shivani</u>
23	Samiksha Kundekar	9145253758	Samikshakundekar@gmail.com	<u>Samiksha</u>
24	Samiksha. Chaudhary	7517090406	chaudharysamiksha26@gmail.com	<u>Samiksha</u>
25	Sayli Lotkande	9356413804	Sayali.Lotkande@gmail.com	<u>Sayli</u>
26	Bhumika D. Chedge	8830391103	bhumikachedge@gmail.com	<u>Bhedge</u>
27	Suman. A. Singh.	7249465307	missumanasingh3@gmail.com	<u>Suman</u>

Signature of:

Programme In-charge

CO-ORDINATOR
ICAC Coordinator

INTER-UNIVERSITY SURVEILLANCE CELL
DHARAMPETH, M. P. DEO MEMORIAL &
SCIENCE COLLEGE, NAGPUR

Principal

PRINCIPAL

Dharampeth M.P. Deo Memorial
Science College, Nagpur-440033



DHARAMPETH M. P. DEO MEMORIAL SCIENCE COLLEGE,
North Ambazari Road, Near Ambazari Lake, Nagpur- 440033

DATA VALIDATION & VERIFICATION (DVV)

Name of the Programme : NMR Spectra of simple organic compounds & its interpretation
Date of the Programme : 4/3/2023
Name of Chief Guest if any : _____
Name of Guest Speaker if any : _____

Sr. No.	Name of the Participant	Mobile Number	E-mail Id	Signature
1.	Nibita Gajanan Ekse	7972190515	eksenibita944@gmail.com	
2.	Khushi Dinesh Amthkar	8767279513	khushiandhkar652@gmail.com	
3.	Arpita D. Gayathane	9527250282	arpitagayathane@gmail.com	
4.	Ishika S. Thakre	800907009	ishithakre29@gmail.com	
5.	Tarunay Choudhary	8600102341	Tchoudhary860010@gmail.com	
6.	Pallavi Y. Bhagat	9022654940	Pallaviy2202@gmail.com	
7.	Varuni M. Goude	7758058514	varunigoude2902@gmail.com	
8.	Nandini S. Hodge	9370301673	nandinihodge17@gmail.com	
9.	Smriti M. Pawar	952988707	SmritiPawar0001@gmail.com	
10.	Sakshi Moon	7745827736	sakshimoon@gmail.com	

Signature of:

Programme In-charge

IQAC Coordinator
COORDINATOR

INTERNAL QUALITY ASSURANCE CELL
DHARAMPETH, M. P. DEO MEMORIAL &
SCIENCE COLLEGE, NAGPUR

Principal

PRINCIPAL

Dharampeth M.P. Deo Memorial
Science College, Nagpur-440033



DHARAMPETH M. P. DEO MEMORIAL SCIENCE COLLEGE,
North Ambazari Road, Near Ambazari Lake, Nagpur- 440033

DATA VALIDATION & VERIFICATION (DVV)

1	Shivani G. Bhute	9302500209	shiveshivani32@gmail.com	Shivani
12	Megha S. Fulwar	8605399606	Meghafulwar@gmail.com	Megha
13	Priyanka D. Bahane	9766166376	Priyankabahane9@gmail.com	Priyanka
14	Vedika P. Karankar	3245249787	vedikalcarankar@gmail.com	Vedika
15	Aishwarya A Joshi	7498328662	aishwaryajoshi100@gmail.com	Aishi
16	Karishma S. Banded	738982507	karishmabanded100@gmail.com	Karishma
17	Akash Ashok. Sikelkar	9175422051	Sikelkarakash01@gmail.com	Akash
18	Vishal. Kumar. Singh.	9610187223	SinghVishal9602@gmail.com	Vishal
19	Manish Bunkhakar (Kankar)	9370329857	manishgandhi79@gmail.com	Manish
20	Nandini P. Pournikar	9764358642	nandinipournikar@gmail.com	Nandini
21	Suhani P. Indurkar	9370419064	suhaniindurkar99@gmail.com	Suhani
22	Manali .S. Shinde	7249637434	manalishinde062	Manali
23	Shreyash R. Chavhan	9307580971	shreyashinn@gmail.com	Shreyash
24	Isha Buepia	9373259849	isha1202buepia@gmail.com	Isha
25	Pranjal P. N. Gokhwar	9130895362	gokhwarpranjal39@gmail.com	Pranjal
26	Ankita R. Bhoyar	8788031173	ankitalakhothar@gmail.com	Ankita

Signature of:

Programme In-charge

IQAC Coordinator

CO-ORDINATOR
INTERNAL QUALITY ASSURANCE CELL
DHARAMPETH, M. P. DEO MEMORIAL &
SCIENCE COLLEGE, NAGPUR

Principal

PRINCIPAL
Dharampeth M.P. Deo Memorial
Science College, Nagpur-440033



DHARAMPETH M. P. DEO MEMORIAL SCIENCE COLLEGE, NAGPUR

INTERNAL QUALITY ASSURANCE CELL (IQAC)

Activity Report

Date: 06-03-2023

Name of Organizing Department or Committee: Department of Statistics.

Name of the activity: Computation of Gross Reproduction rate.

Suggested CRITERION point if any:

Date of Activity: 06th March 2023

Place of Activity: Statistics lab

Name of Guest Speaker/s or Judge/s or Chief Guest/s if any: N.A.

Title of the Activity: Computation of Gross Reproduction rate

Number of Participants: 08

Name of the Teacher: Gauri Sinekar

Names of other Committee Members / Staff: N.A.

OUTCOME of the Activity with respect to mission vision of the institute and or academics:

The data of age group and fertility rates and survival rates of age group (in years) was given to the students. Students read and understood the question, revised the topic of gross reproduction rates and found out the result. Students gain the knowledge about how to analysed the data of Gross Reproduction rate.

Activity with newspaper coverage if any: No

Activity data save in PC of: Department of Statistics

Prof. Pitambar Humane
IQAC Coordinator

CO ORDINATOR
INTERNAL QUALITY ASSURANCE CELL
DHARAMPETH, M. P. DEO MEMORIAL &
SCIENCE COLLEGE, NAGPUR

Name & Signature of Teacher In-charge

Dr. Anillesh Peshwe
Principal

PRINCIPAL
Dharampeth M. P. Deo Memorial
Science College, Nagpur.



DHARAMPETH M. P. DEO MEMORIAL SCIENCE COLLEGE, NAGPUR

INTERNAL QUALITY ASSURANCE CELL (IQAC)

Activity Report

Date: 8th March 2023

Name of Organizing Department or Committee : Electronics Department

Name of the Activity : To study electrical characteristics of UJT, TRIAC and DIAC using datasheet

Suggested CRITERION point if any : Suggested criteria II

Date of Activity : 8th March 2023

Place of Activity : Electronics Lab

Name of Guest Speaker/s or Judge/s or Chief Guest/s if any : Not applicable

Title of the Activity: To study electrical characteristics of UJT, TRIAC and DIAC using datasheet

Based on Unit : 4(Paper I)

Class : Semester II

Number of Participants : 14

Name of the Teacher In-charge / Convener: Mrs. Leena P. Thakare

OUTCOME of the Activity with respect to mission vision of the institute and or academics:

Students studied the technical specifications and applications of 2N2646 UJT, BT136 TRIAC, DB3 DIAC using datasheet.

Prof. Pitambar Humane
CO ORDINATOR
INTERNAL QUALITY ASSURANCE CELL
DHARAMPETH, M. P. DEO MEMORIAL &
SCIENCE COLLEGE, NAGPUR

Prof. Varsha V. Rangari
Dr. Varsha V. Rangari
Professor & Head
Head of the Department
Department of Electronics
Dharampeth M.P. Deo Memorial
Science College, Nagpur

Dr. Akhlesh Peshwe
Principal
Principal
Dharampeth M.P. Deo Memorial
Science College, Nagpur.



DHARAMPETH M. P. DEO MEMORIAL SCIENCE COLLEGE, NAGPUR
Department of Electronics
Semester II- (2022-23)
Activity (Paper I - Unit- 4)

Sr. No.	Student Name	Mobile Number	Email ID
1	Tanu Ajay Singh	8806355808	tanusingh63492@gmail.com
2	Tushal Rupkumar Achare	9075995617	acharetushal5@gmail.com
3	Vedant Onkar Umretkar	9049932753	umretkarvedant@gmail.com
4	Isha Ishwar Waghmare	8855919474	ishawaghmare9474@gmail.com
5	Simran Narendra Dhimole	8390347026	mishralaxmi210@gmail.com
6	Priyanshu Pradeep Singh	9527710380	priyanshusinghji12@gmail.com
7	Kashish Kamalkumar Bisen	7887886117	kashishbisen05@gmail.com
8	Aayushi Vikram Singh	9595119942	senxerox04@gmail.com
9	Bhagyashali Dadarao Neware	7796434177	sakshineware2017@gmail.com
10	Vaidhavi Baburao Gongal	7507907278	gayatrigongal787@gmail.com
11	Tejas Rajesh ChelmeIwar	9604662119	tejaschelmeIwar@gmail.com
12	Tannu Arun Varthi	9322044903	tannuvarthi@gmail.com
13	Sandeep Rakesh Kumar Kumar	8081144948	sandeepk27900@gmail.com
14	Abhishek Ravindra Singh	8208948107	abhi0882005@gmail.com

Name & Signature of Teacher In-Charge

Prof. Pitambar Humane
IQAC Coordinator

CO ORDINATOR
INTERNAL QUALITY ASSURANCE CELL
DHARAMPETH, M. P. DEO MEMORIAL &
SCIENCE COLLEGE, NAGPUR

Name & Signature of Head of the Department

Dr. Varsha V. Rangari
Professor & Head

Department of Electronics

Dharampeth M.P. Deo Memorial

Science College, Nagpur

Dr. Akhilesh Peshwe
Principal

Principal
Dharampeth M.P. Deo Memorial
Science College, Nagpur.



ELECTRONICS, INC.
 44 FARRAND STREET
 BLOOMFIELD, NJ 07003
 (973) 748-5089
<http://www.nteinco.com>

2N2646 Unijunction Transistor TO-18 Package

Description:

The 2N2646 is designed for use in pulse and timing circuits, sensing circuits and thyristor trigger circuits.

Features:

- Low Peak Point Current: 5 μ A (Max)
- Low Emitter Reverse Current: .005 μ A (Typ)
- Passivated Surface for Reliability & Uniformity

Absolute Maximum Ratings: ($T_A = +25^\circ\text{C}$ unless otherwise specified)

Power Dissipation (Note 1), P_D	300mW
RMS Emitter Current, $I_{E(RMS)}$	50mA
Peak Pulse Emitter Current (Note 2), i_E	2A
Emitter Reverse Voltage, V_{B2E}	30V
Interbase Voltage, V_{B2B1}	35V
Operating Junction Temperature Range, T_J	-65° to 125°C
Storage Temperature Range, T_{stg}	-65° to $+150^\circ\text{C}$

Note 1 Derate 3mW/ $^\circ\text{C}$ increase in ambient temperature. The total power dissipation (available power to Emitter and Base-Two) must be limited by the external circuitry.

Note 2 Capacitor discharge - 10 μ F or less, 30 volts or less

Electrical Characteristics: ($T_A = +25^\circ\text{C}$ unless otherwise specified)

Parameter	Symbol	Test Conditions	Min	Typ	Max	Unit
Intrinsic Standoff Ratio	η	$V_{B2B1} = 10\text{V}$, Note 3	0.56	-	0.75	-
Interbase Resistance	r_{BB}	$V_{B2B1} = 3\text{V}$, $I_E = 0$	4.7	7.0	9.1	k Ω
Interbase Resistance Temperature Coefficient	αr_{BB}		0.1	-	0.9	%/ $^\circ\text{C}$

Note 3. Intrinsic standoff ratio, η is defined by equation:

$$\eta = \frac{V_P - V_F}{V_{B2B1}}$$

where V_P = Peak Point Emitter Voltage
 V_{B2B1} = Interbase Voltage
 V_F = Emitter to Base-One Junction Diode Drop ($\sim 0.45\text{V}$ @ 10 μ A)



Continental Device India Limited

An ISO/TS 16949, ISO 9001 and ISO 14001 Certified Company



BT136

TO-220

Triac Series

Absolute maximum ratings

Parameter	Symbol	Value	Unit	Test condition
peak repetitive off-state voltage	V_{DRM}, V_{RRM}	600	V	
on-state RMS current	$I_T(RMS)$	4	A	$T_L \leq 65^\circ C$
NON repetitive surge peak on-state current	I_{TSM}	25	A	$T_p=20ms; T_j=25^\circ C$
critical rate of rise on-state current	$di/dt (Q_{1-3})$	50	A/ μs	$I_M=20A, T_G=0.2A$
peak gate current	I_{GM}	2	A	
average gate power dissipation	$P_G(AV)$	0.5	W	
storage temperature range	T_{stg}	-40 to +150	$^\circ C$	
operating junction temperature range	T_j	125	$^\circ C$	

Electrical characteristics ($T_j=25^\circ C$) unless otherwise specified

Parameter	Symbol	Value	Unit	Test condition
gate trigger current	I_{GT}	≤ 10	mA	T2+G+ $V_D=12V, I_T=0.1A$
		≤ 10	mA	T2+G- $V_D=12V, I_T=0.1A$
		≤ 10	mA	T2-G- $V_D=12V, I_T=0.1A$
		≤ 25	mA	T2-G+ $V_D=12V, I_T=0.1A$
gate trigger voltage	V_{GT}	≤ 1.5	V	$V_D=12V, I_T=0.1A$
hold current	I_H	≤ 30	mA	$V_D=12V, I_T=0.1A$
critical rate of rise off-state voltage	dv/dt	≥ 50	V/ μs	$V_G=87\%V_{DRM}$
on-state voltage	V_{TM}	≤ 1.7	V	$I_T=5A$
off-state leakage current	I_{ORM}	≤ 0.5	mA	$V_D=V_{DRM}; T_j=125^\circ C$
thermal resistance	$R_{th(j-a)}$	60	$^\circ C/W$	
	$R_{th(j-c)}$	≤ 3.7		

Disclaimer

The product information and the selection guides facilitate selection of the CDIL's Discrete Semiconductor Device(s) best suited for application in your product(s) as per your requirement. It is recommended that you completely review our Data Sheet(s) so as to confirm that the Device(s) meet functional parameters for your application. The information furnished in the Data Sheet and on the CDIL Web Site/CD are believed to be accurate and reliable. CDIL however, does not assume responsibility for inaccuracies or incomplete information. Furthermore, CDIL does not assume liability whatsoever, arising out of the application or use of any CDIL product; neither does it convey any license under its patent rights nor rights of others. These products are not designed for use in life saving/support appliances or systems. CDIL customers selling these products (either as individual Discrete Semiconductor Devices or incorporated in their end products), in any life saving/support appliances or systems or applications do so at their own risk and CDIL will not be responsible for any damage resulting from such sale(s).

CDIL strives for continuous improvement and reserves the right to change the specifications of its products without prior notice.



CDIL is a registered Trademark of

Continental Device India Limited

C-120 Naraina Industrial Area, New Delhi 110 028, India

Telephone + 91-11-2579 6150, 4141 1112 Fax + 91-11-2579 5290, 4141 1119

email@cdil.com www.cdilsemi.com

DIAC

Features

1. V_{BO} : 32V
2. Breakover voltage range: 28 to 36V

Applications

Functioning as a trigger diode with a fixed voltage reference, the DB3 can be used in conjunction with triacs for simplified gate control circuits or as a starting element in fluorescent lamp ballasts.



Absolute Maximum Ratings

(Limiting values)

Parameter	Symbol	Value	Unit
Repetitive peak on-state current ($t_p=20\mu s$ F=120 Hz)	I_{TBM}	2	A
Operating junction temperature range	T_j	-40 ~ +125	°C
Storage temperature range	T_{stg}	-40 ~ +125	°C

Electrical Characteristics

($T_f=25^\circ$ unless otherwise specified)

Parameter	Symbol	Test Conditions	Value	Unit	
Breakover voltage*	V_{BO}	C=22nF**	MIN.	28	V
			TYP.	32	
			MAX.	36	
Breakover voltage symmetry	$ V_{BO1}-V_{BO2} $	C=22nF**	MAX.	± 3	V
Dynamic breakover voltage*	? V	V_{BO} and V_F at 10mA	MIN.	5	V
Output voltage*	V_O	see diagram 2(R=20 Ω)	MIN.	5	V
Breakover current*	I_{BO}	C=22nF**	MAX.	50	μ A
Rise time*	t_r	see diagram 3	MAX.	2	μ s
Leakage current*	I_L	$V_R=0.5V_{BO}$ max	MAX.	10	μ A

*Applicable to both forward and reverse directions.

**Connected in parallel to the device.

Diagram 1: Voltage - current characteristic curve.

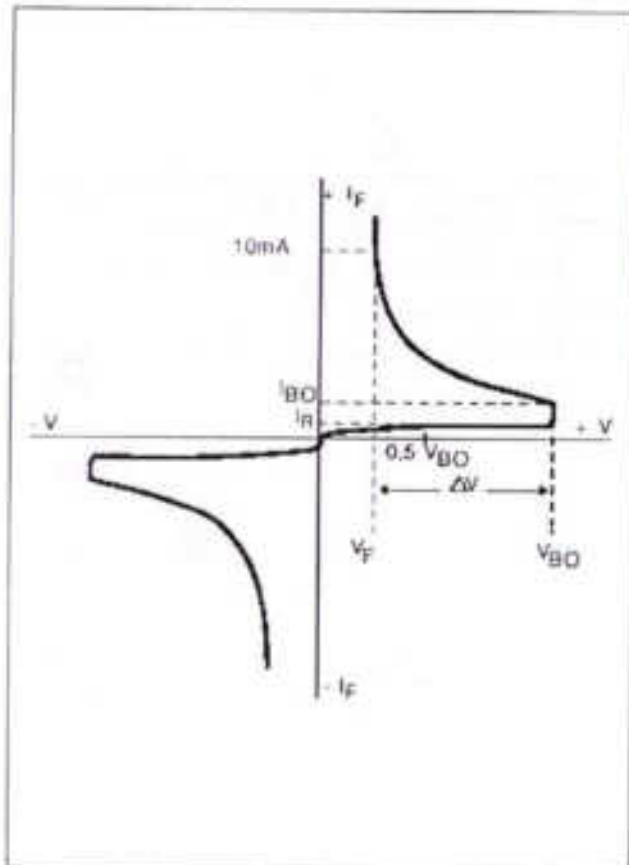

Diagram 2: Test circuit.

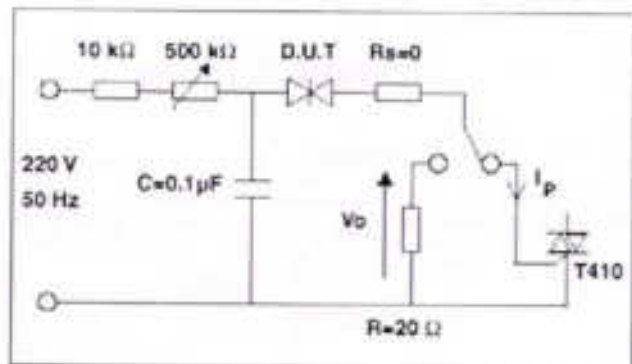
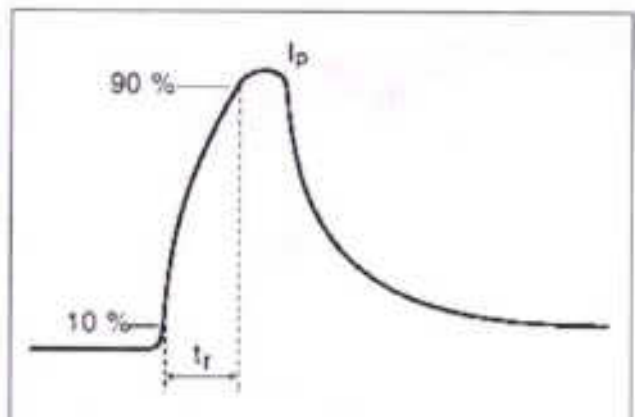
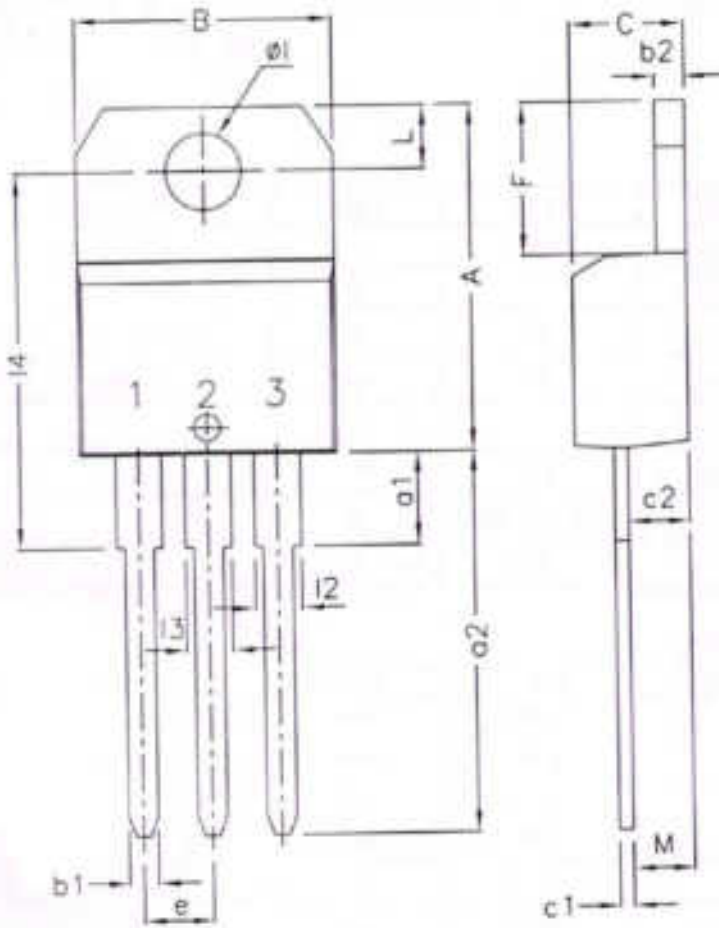

Diagram 3: Rise time measurement.



PACKAGE TO-220 AB



DIM	MIN	TYP.	MAX
A	15.20		15.90
a1		3.75	
a2	13.00		14.00
B	10.00		10.40
b1	0.61		0.88
b2	1.23		1.32
C	4.40		4.60
c1	0.49		0.70
c2	2.40		2.72
e	2.40		2.70
F	6.20		6.60
i	3.75		3.85
i4	15.80	16.40	16.80
L	2.65		2.95
i2	1.14		1.70
i3	1.14		1.70
M		2.60	

ALL DIMENSIONS ARE IN mm

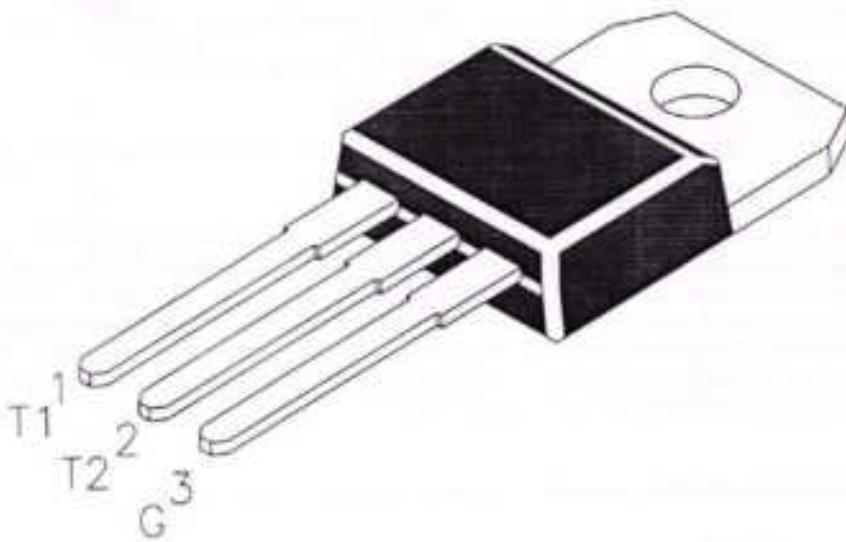

PIN CONFIGURATION:-

1. MAIN TERMINAL 1
2. MAIN TERMINAL 2
3. GATE

Electrical Characteristics (Cont'd): ($T_A = +25^\circ\text{C}$ unless otherwise specified)

Parameter	Symbol	Test Conditions	Min	Typ	Max	Unit
Emitter Saturation Voltage	$V_{EB1(sat)}$	$V_{B2B1} = 10\text{V}, I_E = 50\text{mA}$, Note 4	-	3.5	-	V
Modulated Interbase Current	$I_{B2(mod)}$	$V_{B2B1} = 10\text{V}, I_E = 50\text{mA}$	-	15	-	mA
Emitter Reverse Current	I_{EB20}	$V_{B2E} = 30\text{V}, I_{B1} = 0$	-	0.005	12	μA
Peak Point Emitter Current	I_P	$V_{B2B1} = 25\text{V}$	-	1	5	μA
Valley Point Current	I_V	$V_{B2B1} = 20\text{V}, R_{B2} = 100\Omega$	4	6	-	mA
Base-One Peak Pulse Voltage	V_{OB1}		3	5	-	V

Note 4. Use pulse techniques: Pulse Width - $300\mu\text{s}$, duty cycle $\leq 2\%$ to avoid internal heating due to interbase modulation which may result in erroneous readings.

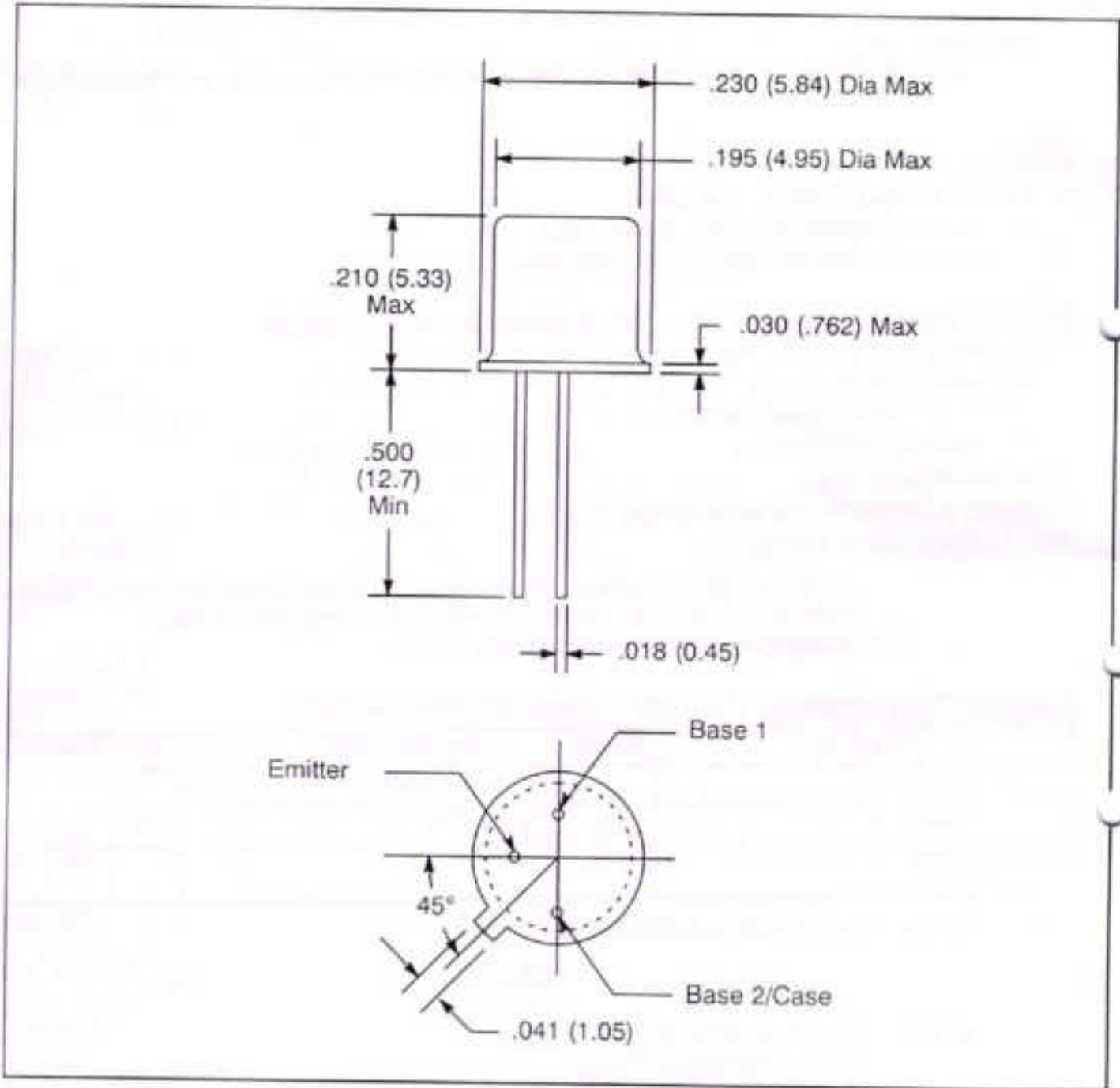



DHARAMPETH M. P. DEO MEMORIAL SCIENCE COLLEGE, NAGPUR
INTERNAL QUALITY ASSURANCE CELL (IQAC)
NEP Activity Report

Date: 09/03/2023

Name of Organizing Department or Committee: Chemistry Department

Name of the activity: NEP Activity Report (Sem- IV, Unit-III)

Suggested CRITERION point if any: Criteria II

Date of Activity: 08/03/2023

Place of Activity: Chemistry Department Laboratory

Name of Guest Speaker/s or Judge/s or Chief Guest/s if any: Nil

Title of the Activity: Demonstration of general Chromatographic Technique

Number of Participants: 48

Name of the Teacher In-charge / Convener: Ms. Niharika A. Sute

Names of other Committee Members / Staff: Dr. Vaishali Meshram

OUTCOME of the Activity with respect to mission vision of the institute and or academics:

This is student centric activity. In this activity students have learned how Samples to be spotted at a proper position on the paper by using a capillary tube and also the development of Chromatogram which is spotted by immersing the paper in the mobile phase.

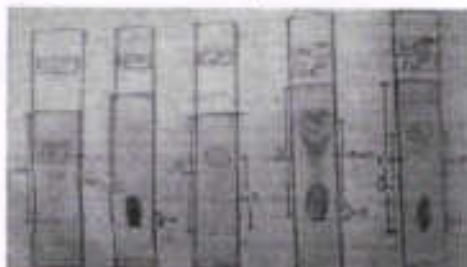

Activity with newspaper coverage if any: Nil

Activity data save in PC of: Chemistry Department

Note: Kindly share geotag photographs separately along with report on iqaodsc2022@gmail.com

Prof. Pitambar Humane
IQAC Coordinator

CO ORDINATOR
INTERNAL QUALITY ASSURANCE CELL
DHARAMPETH, M. P. DEO MEMORIAL &
SCIENCE COLLEGE, NAGPUR

(N. Sute)
(Niharika A. Sute)
Name & Signature of Teacher In-charge

Dr. Akhilesh Peshwe
Principal

PRINCIPAL
Dharampeth M.P. Deo Memorial
Science College, Nagpur-440012



DHARAMPETH M. P. DEO MEMORIAL SCIENCE COLLEGE,
North Ambazari Road, Near Ambazari Lake, Nagpur-440033

DATA VALIDATION & VERIFICATION (DVV)

Name of the Programme : NEP Activity-3 on unit-III, paper-I (Sem-IV)
Date of the Programme : Demonstration of general chromatographic Technique
Name of Chief Guest if any : —
Name of Guest Speaker if any : —

Sr. No.	Name of the Participant	Mobile Number	E-mail Id	Signature
1)	Jyoti. J. Sharma	8669736380	jyotis3390@gmail.com	J Sharma
2)	Sonia Midhat A. Kap	8975726700	midhatsonia@gmail.com	Sonia
3)	AMAN. A. DONGRE	7709217312	amandongre2003@gmail.com	A Dongre
4)	Siddharth G. Hirkane	9579092931	hirkanesiddharth@gmail.com	Siddharth
5)	Shreya S. Dhawale	8888264004	shreyadhawale124@gmail.com	Shreya
6)	Urmila V. Bondre	9370673867	BondreUrmila2001@gmail.com	Urmila
7)	Vaibhavi A. Shinde	8080640782	Vaibhavishinde97@gmail.com	Vaibhavi
8)	Kalpna Sushagpure	9579236712	kalpansushagpure@gmail.com	Kalpna
9)	Mansi I. Mate	8468891807	Mansi19182@gmail.com	Mansi
10)	SAMIR P. GHUMDE	9359236713	Sameerghum2002@gmail.com	S P Ghumde

Signature of:

Programme In-charge

(Niharika A. Sute)

IQAC Coordinator

CO ORDINATOR

INTERNAL QUALITY ASSURANCE CELL
DHARAMPETH M. P. DEO MEMORIAL &
SCIENCE COLLEGE, NAGPUR

Principal

PRINCIPAL

Dharampeth M.P. Deo Memorial
Science College, Nagpur-440033



DHARAMPETH M. P. DEO MEMORIAL SCIENCE COLLEGE,
North Ambazari Road, Near Ambazari Lake, Nagpur- 440033

DATA VALIDATION & VERIFICATION (DVV)

11.	Jagruti D. Warkar	7447366023	jagrutiwarkar09@gmail.com	Jagruti
12.	Sakshi S. Meshram	9145355733	sakshimeshram210@gmail.com	Sakshi
13.	Rutika M. Wamra	9356744234	rutikaw929@gmail.com	Rutika
14.	Rutika V. Gaybhaye	7620526960	rutikagaybhaye05@gmail.com	Rutika
15.	Juhi S. Chaudhari	8669248944	chaudharijuhi12@gmail.com	Juhi
16.	Shital R. Ketzarkar	9373385046	shital2020KK@gmail.com	@ketzarkar
17.	Sejal R. Lakhampal	9028851568	sejallakhampal@gmail.com	Sejal
18.	Kalyani C. Shahare	9307046378	shaharekalyani5@gmail.com	Kalyani
19.	Vaishnavi T. Kapse	8983751089	vaishnavikapse05@gmail.com	Vaishnavi
20.	Sagar S. Bawane	9975466979	Sagarbawane637@gmail.com	S.Bawane
21.	Jasraj D. Paliwal	9370820325	jasrajpaliwal47@gmail.com	Jasraj
22.	Shashank Pandey	9998644684	pandeyshashank952@gmail.com	Shashank
23.	Darshana Madavi	9830146516	Darshnamadavi@gmail.com	Darshana
24.	Nupur Sharma	9822042269	nupursharma258@gmail.com	Nupur
25.	Kajal Prasad	7410763138	prasadkajal2004@gmail.com	Kajal Prasad
26.	Riya Pandit	93706161353	panditriya753@gmail.com	Riya

Signature of:

Programme In-charge

Niharsika A. Sute

IQAC Coordinator

CO ORDINATOR

INTERNATIONALITY & SURVIVAL CELL
DHARAMPETH M. P. DEO MEMORIAL &
SCIENCE COLLEGE, NAGPUR

Principal

PRINCIPAL

Dharampeth M.P. Deo Memorial
Science College, Nagpur-440033



DHARAMPETH M. P. DEO MEMORIAL SCIENCE COLLEGE,
North Ambazari Road, Near Ambazari Lake, Nagpur- 440033

DATA VALIDATION & VERIFICATION (DVV)

27]	Divya -K. Hanote	8605422901	divyahanote0406@gmail.com	Dhanote
28)	Sumit . Bandebuche	8788212339	Sumitbandebuche100@gmail.com	Sumit
29]	Vaishnavi Gadge	9022976449	gadgavaishnavi00@gmail.com	Gadge
30]	Vedant Bary	8530455796	vedantbary2003@gmail.com	Bary
31]	Pranjal Bhoyar	8010434634	Pranjalb738@gmail.com	Bhoyar
32)	Vaishnavi J. Bedade	8657188033	vaishnavibedade100@gmail.com	Bedade
33]	Chakuli Wadikar	93250479087	chakuliwadikar10@gmail.com	Chakuli
34]	Anjali Mishra	9825604513	anjalmishra930@gmail.com	Anjali
35)	Shrawani Wasthede	7058368837	shrawaniwasthede10@gmail.com	Shrawani
36]	Vaishnavi Mandapure	9922439316	vaishnavimandapure36@gmail.com	Mandapure
37]	Rupesh Bhokre	88058887370	bhokrerupesh@gmail.com	Bhokre
38]	Poinkle Lokhande	8149176609	twinkal@gmail.com	Lokhande
39]	Dhanshree Newalkar	9356516280	newalkardhanshree@gmail.com	Newalkar
40]	Mansi Maht	7385114931	mansimaht@gmail.com	Maht
41]	Shyamal D. Nayak	9765943998	shyamalnayak@gmail.com	Nayak
42]	Pooja Itankar	9156973252	poojaitankar987@gmail.com	Itankar

Signature of:

Programme In-charge

(Niharika A. Sute)

IQAC Coordinator

CO ORDINATOR

INTERNAL QUALITY ASSURANCE CELL
DHARAMPETH M. P. DEO MEMORIAL &
SCIENCE COLLEGE, NAGPUR

Principal

PRINCIPAL

Dharampeth M.P. Deo Memorial
Science College, Nagpur-440033



DHARAMPETH M. P. DEO MEMORIAL SCIENCE COLLEGE, NAGPUR
INTERNAL QUALITY ASSURANCE CELL (IQAC)

Activity Report (NEP: 2022-23)

Date: 30/03/23

Name of Organizing Department or Committee: Zoology

Name of the activity: Hands on training on micro techniques

Suggested CRITERION point if any: Criteria 1

Date of Activity: 09/03/2023

Place of Activity: Zoology Laboratory

Name of Guest Speaker judge/s or Chief Guest/s if any:

Title of the Activity: Hands on training on micro techniques

Number of Participants: 28

Name of the Teacher In-charge / Convener: Dr. Kishor T. Waghmare

Names of other Committee Members / Staff:

OUTCOME of the Activity with respect to mission vision of the institute and or academics:

- 1) This session on the micro technique is found interesting and enjoyable to explore the horizon of knowledge.
- 2) Students understand concept easily by practical demonstration and later by performing.
- 3) Students actively participated in this activity which helps them to understand and know the difficulties occur during the whole process, as well as how to overcome to it.
- 4) This activity helps student in to visualize the cellular structure and architecture of tissue at the final stage of activity
- 5) Students develop skill which makes them confident and try for perfection.

Activity with newspaper coverage if any: NIL

Activity data save in PC of: Zoology Department/personal laptop



Prof. Pitambar Humane
IQAC Coordinator

CO ORDINATOR
INTERNAL QUALITY ASSURANCE CELL
DHARAMPETH, M. P. DEO MEMORIAL &
SCIENCE COLLEGE, NAGPUR

Dr. Kishor T. Waghmare
Name & Signature of Teacher In-charge

Dr. Akhilesh Peshwe
Principal

Principal
Dharampeth M. P. Deo Memorial
Science College, NAGPUR.



DHARAMPETH M. P. DEO MEMORIAL SCIENCE COLLEGE,
North Ambazari Road, Near Ambazari Lake, Nagpur- 440033

DATA VALIDATION & VERIFICATION (DVV)

Name of the Programme : Hands on Training on Micro-techniques
Date of the Programme : 08/03/2023
Name of Chief Guest if any : -
Name of Guest Speaker if any : -

Sr. No.	Name of the Participant	Mobile Number	E-mail Id	Signature
1.	Maunali R. Sonare	9850163812	sonaremaunali16@gmail.com	
2.	Rani B. Patule	9011247038	brani8112@gmail.com	
3.	Rakhi P. Gedam	7378312504	gedamrakhi2000@gmail.com	
4.	Neha A. Waghade	7249895144	nehawaghade16082002@gmail.com	
5.	Vanshika C. Yede	7558244609	vanshikayede1@gmail.com	
6.	Shubham P. Khobragade	9518788915	shubhamkhobragade2002@gmail.com	
7.	Saniya P. Naik	9370570457	sanianaik51@gmail.com	
8.	Prajwal P. Mungle	9839234902	prajwalmungle123@gmail.com	
9.	Sakshi V. Chamate	7709204933	chamate.sakshien@gmail.com	
10.	Sakshi S. Guici	9529660277	sakshigiciz04@gmail.com	
11.	Vaishnavi R. Chandekar	7249882964	vaishnavichandekar00@gmail.com	
12.	Sushela S. Pawar	7507439390	sushelapawar224@gmail.com	
13.	Sonam M. Uprade	9890230468	upradesonam@gmail.com	
14.	Aapita T. Dakhale	8010886758	aapitadakhale02@gmail.com	

Signature of:
Programme In-charge

COORDINATOR
INTERNAL QUALITY ASSURANCE CELL
DHARAMPETH, M. P. DEO MEMORIAL &
SCIENCE COLLEGE, NAGPUR

Principal
Principal
Dharampeth M. P. Deo Memorial
Science College, Nagpur



DHARAMPETH M. P. DEO MEMORIAL SCIENCE COLLEGE,
North Ambazari Road, Near Ambazari Lake, Nagpur- 440033

DATA VALIDATION & VERIFICATION (DVV)

Sr. No.	Name of the Participant	Mobile Number	E-mail Id	Signature
15)	Neha Ravindra Khawase	8766738340	neha2002kk@gmail.com	
16)	Shrushti M. Gaikwad	7385532105	shrushtigaikwad86935@gmail.com	
17)	Nandini S. Hedge	9270301679	nandinihedge17@gmail.com	
18)	Sanket Dode	7972085380	sanketdode123@gmail.com	
19)	Suraj Yadav	8767635158	surajyadav182@gmail.com	
20)	Darshi Gorte	7758058514	darshigorte2902@gmail.com	
21)	Ishika Thakre	800907069	ishithakre22@gmail.com	
22)	Rishakha Grawhade	4620351270	rishakha2020gg@gmail.com	
23)	Nandini P. Pounikar	9764359642	nandnipounikar@gmail.com	
24)	Suhani P. Indurkar	9370419064	suhaniindurkar990@gmail.com	
25)	Manish S. Grade	9370329857	manishgrade79@gmail.com	
26)	Manali S. Shinde	7249637434	manalishinde062@gnc	
27)	Vaishnavi K. Kharkate	9763286915	vaishnavikharkate00@gmail.com	
28)	Sakshi P. Mankar	8180816539	sakshi2018mmm@gmail.com	

Signature of:
Programme In-charge

CO-ORDINATOR
INTERNAL QUALITY ASSURANCE CELL
DHARAMPETH, M. P. DEO MEMORIAL &
SCIENCE COLLEGE, NAGPUR

Principal
Dharampeth M. P. Deo Memorial
Science College, NAGPUR



DHARAMPETH M. P. DEO MEMORIAL SCIENCE COLLEGE, NAGPUR

INTERNAL QUALITY ASSURANCE CELL (IQAC)

Activity Report

Date:9/03/2023

Name of Organizing Department or Committee: Department of Mathematics

Name of the activity: NEP based To construct new examples on Second order linear differential equations for B.Sc. Semester-II

Suggested CRITERION point if any: Criterion I.

Date of Activity: 9/03/2023

Place of Activity: Class room

Name of Guest Speaker/s or Judge/s or Chief Guest/s if any: NA

Title of the Activity: To construct new examples on Second order linear differential equations

Activity with newspaper coverage if any: No

Number of Participants: B.Sc. Semester-II Students (44)

Name of the Teacher In-charge / Convener: Dr. N. P. Gaikwad

Names of other Committee Members / Staff: Mr.Roshan Thakre

OUTCOME of the Activity with respect to academics:

Second-order linear differential equations have a variety of applications in science and engineering. In this section we explore two of them: the vibration of springs and electric circuits. The theory of second-order partial differential equations has found extensive applications in the study of problems in fluid mechanics, flow in porous media, heat conduction in solids, diffusive transport of chemicals in porous media, wave propagation in strings and membranes, and in mechanics of solids.

DVV: Enclosed.

Name & Signature of Teacher In-charge

Prof. Pitambar Humane

IQAC Coordinator

IQAC Co-ordinator

Dharampeth M.P. Deo Memorial
Science College, Nagpur-440033

Dr. Akhilesh Peshwe

Principal

PRINCIPAL

Dharampeth M.P. Deo Memorial
Science College, Nagpur-440033



DHARAMPETH M. P. DEO MEMORIAL SCIENCE COLLEGE,
North Ambazari Road, Near Ambazari Lake, Nagpur- 440033

DATA VALIDATION & VERIFICATION (DVV)

Name of the Programme : NEP based To construct new examples
Date of the Programme : 09/03/2023 | on second order linear
Name of Chief Guest if any : differential equations for
Name of Guest Speaker if any : B.Sc Semester - II

Sr. No.	Name of the Participant	Mobile Number	E-mail Id	Signature
1.	Simran Dhimala	7666330683	simrandhimala8@gmail.com	Dhimala
2.	Abhishek Singh	8708948107	abhi0882005@gmail.com	Abinath
3.	Vedant O. Ursethkar	9049932753	ursethkarvedant@gmail.com	Ursethkar
4.	Poojitksha Borseve	9574836818	poojitkshaborseve4@gmail.com	Borseve
5.	Badal G. Somkuwar	7448247750	badalsomkuwar1@gmail.com	Somkuwar
6.	Tanuja G. Yeluzi	9529447565	tanujayeluzi788@gmail.com	Tanuja Yeluzi
7.	Pranali V. Kupta	7020062377	29991537@gmail.com	Kupta
	Janvi V. Khode	7385086684	Janvikhode892@gmail.com	Khode
	Dhyanika V. Zagade	9022866318	Dhyanikazagade@gmail.com	Zagade
	Sanika Panchavdekar	9763075890	sanikapanchavdekar3@gmail.com	Panchavdekar

Signature of:

Programme In-charge

IQAC Coordinator
IQAC Co-ordinator

Dharampeth M.P. Deo Memorial
Science College, Nagpur-440033

Principal
PRINCIPAL

Dharampeth M.P. Deo Memorial
Science College, Nagpur-440033



DHARAMPETH M. P. DEO MEMORIAL SCIENCE COLLEGE,
North Ambazari Road, Near Ambazari Lake, Nagpur- 440033

DATA VALIDATION & VERIFICATION (DVV)

Priyanshu Singh	95277 10280	Priyanshusingh1002@gmail.com	Priyanshu
Vibhanshu Tare	9561232204	Vibhanshutare78@gmail.com	Vibhanshu
Tejas Dongre	9322578918	Tj9874k@gmail.com	Tejas
Poochi S Gaikwad	9385412959	Poochisgaikwad@gmail.com	Poochi
Tushar Achare	9075995617	archanushals@gmail.com	Tushar
Gendal B Machade	9112142728	nishalmachade2005@gmail.com	Gendal
uday C. Doghole	8463349603	bigholeuday@gmail.com	Uday
Arket J Bawankar	9767219301	ArketBawankar@gmail.com	Arket
Mohit Khirdekar	8053 328357	mohitkhirdekar@gmail.com	Mohit
Bhagyaswati D. Newase	7796434177	sakshinewase2017@gmail.com	Bhagyaswati
Tejas R Chelmechavhan	9641662119	tejaschelmechavhan@gmail.com	Tejas
Janhvi Laibey	8466510539	Janhvilaibey@gmail.com	Janhvi
Janhvi Jage	7385060871	Janhvijage08@gmail.com	Janhvi
Jannu A valthi	9322044903	jannuvalthi@gmail.com	Jannu
Janhvi Kishnapure	7058835243	janhvikishnapure@gmail.com	Janhvi

Signature of:

Programme In-charge

IQAC Coordinator

IQAC Co-ordinator

Dharampeth M. P. Deo Memorial
Science College, Nagpur-440033

Principal
PRINCIPAL

Dharampeth M. P. Deo Memorial
Science College, Nagpur-440033



DHARAMPETH M. P. DEO MEMORIAL SCIENCE COLLEGE,
North Ambazari Road, Near Ambazari Lake, Nagpur- 440033

DATA VALIDATION & VERIFICATION (DVV)

Utkarsha Ingale	7493159178	utkarshaingale@gmail.com	Utkarsha Ingale
Pradnya Tiwari	800362232	pradnyatiwari9145@gmail.com	Pradnya Tiwari
Chetna Pradhe	8010342968	Pradhe Chetna@gmail.com	C. Pradhe
Rudika Yadav	8446085943	rudikayadav434@gmail.com	Rudika Yadav
Sakshi Mishra	9529089315	Smitra939683@gmail.com	Smitra
Veersha Turkar	9373650990	veershaturkar488@gmail.com	Veersha Turkar
Mounali D. Bhilkar	91322427616	MounaliBhilkar@gmail.com	Mounali Bhilkar
Isha I. Waghmare	8855919474	Ishawaghmare9474@gmail.com	Isha Waghmare
Nikhil Kale	9529113941	nikhilkale1805@gmail.com	Nikhil Kale
Susmita Dubey	7620190198	Susmita Dubey 144	Susmita Dubey
Trishabh Saha	8087300294	trishabhsaha00@gmail.com	Trishabh Saha
Monu P. Pal	78509505079	monupal78509505079@gmail.com	Monu P. Pal
Tushar Achare	9075995617	achare.tushar@gmail.com	Tushar Achare
Aman Kari	9028837552	kari7817@gmail.com	Aman Kari
Rohit Pandey	8767788703	8767788703@gmail.com	Rohit Pandey
Suraj M. Mishra	9730839023	surajmishra9730839023@gmail.com	Suraj M. Mishra

Signature of:

Programme In-charge

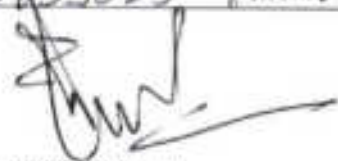
IQAC Coordinator

IQAC Co-ordinator

Dharampeth M. P. Deo Memorial
Science College, Nagpur-440033

Principal

PRINCIPAL

Dharampeth M. P. Deo Memorial
Science College, Nagpur-440033



DHARAMPETH M. P. DEO MEMORIAL SCIENCE COLLEGE,
North Ambazari Road, Near Ambazari Lake, Nagpur- 440033

DATA VALIDATION & VERIFICATION (DVV)

Shrutika G. Pise	9322316336	shrutikagpise67@gmail.com	shrutika g. pise
Malima Khate	9545918618	malimakhate11@gmail.com	malima khate
Tanu A. Singh	8806355808	Tanusingh53492@gmail.com	Tanu
Divyani G. Zade	7972403069	divyanizade2005@gmail.com	Divyani Zade
Vaidhi Nagolkar	9325963446	Vaidhinagolkar07@gmail.com	Vaidhi Nagolkar
Samiksha Shendre	7420881158	samikshashendre08@gmail.com	Samiksha Shendre
Pratik Chalkh	9021640532	pratikchalkh7@gmail.com	Pratik Chalkh
Pratish Golait	9579343851	Pratishgolait99@gmail.com	Pratish Golait
Nayan N. Wadhwa	7341870747	Nayanwadhw2@gmail.com	Nayan Wadhwa

Signature of:

Programme In-charge

IQAC Coordinator
IQAC Co-ordinator

Dharampeth M. P. Deo Memorial
Science College, Nagpur-440033

Principal
PRINCIPAL

Dharampeth M. P. Deo Memorial
Science College, Nagpur-440033



DHARAMPETH M. P. DEO MEMORIAL SCIENCE COLLEGE, NAGPUR

INTERNAL QUALITY ASSURANCE CELL (IQAC)

Activity Report

Date: 11th March 2023

Name of Organizing Department or Committee : Electronics Department

Name of the Activity : To study CMOS NAND IC and TTL NAND IC datasheet and compare them.

Suggested CRITERION point if any : Suggested criteria II

Date of Activity : 11th March 2023

Place of Activity : Electronics Lab

Name of Guest Speaker/s or Judge/s or Chief Guest/s if any : Not applicable

Title of the Activity: To study CMOS NAND IC and TTL NAND IC datasheet and compare them.

Based on Unit : 1(Paper II)

Class : Semester II

Number of Participants : 19

Name of the Teacher In-charge / Convener: Mrs. Leena P. Thakare

OUTCOME of the Activity with respect to mission vision of the institute and or academics:

Students studied the technical specifications and applications of CMOS NAND IC 4011 and TTL NAND IC 74HC00 using datasheet.

Prof. Pitambar Humane
CO ORDINATOR
INTERNAL QUALITY ASSURANCE CELL
IQAC Coordinator
DHARAMPETH, M. P. DEO MEMORIAL &
SCIENCE COLLEGE, NAGPUR

Dr. Manish W. Rangari
Professor & Head
Department of Electronics
Dharampeth M. P. Deo Memorial
Science College, Nagpur

Dr. Akhilesh Peshwe
Principal
Dharampeth M. P. Deo Memorial
Science College, Nagpur.



DHARAMPETH M. P. DEO MEMORIAL SCIENCE COLLEGE, NAGPUR
Department of Electronics
Semester II- (2022-23)
Activity (Paper II- Unit- 1)

Sr. No.	Student Name	Mobile Number	Email ID
1	Tanu Ajay Singh	8806355808	tanusingh63492@gmail.com
2	Sandeep Rakesh Kumar Kumar	8081144948	sandeepk27900@gmail.com
3	Abhishek Ravindra Singh	8208948107	abhi0882005@gmail.com
4	Vedant Onkar Umretkar	9049932753	umretkarvedant@gmail.com
5	Tannu Arun Varthi	9322044903	tannuvarthi@gmail.com
6	Kashish Kamalkumar Bisen	7887886117	kashishbisen05@gmail.com
7	Aayushi Vikram Singh	9595119942	senxerox04@gmail.com
8	Vaidhavi Baburao Gongal	7507907278	gayatrigongal787@gmail.com
9	Monali Narendraji Shende	7796516257	shendemonali92@gmail.com
10	Simran Narendra Dhimole	8390347026	mishralaxmi210@gmail.com
11	Isha Ishwar Waghmare	8855919474	ishawaghmare9474@gmail.com
12	Bhagyashali Dadarao Neware	7796434177	sakshineware2017@gmail.com
13	Khushbu Rajiv Pali	8459565214	palikhushbu59@gmail.com
14	Harshata Gunderao Warkhede	9860432428	bandukeshao20@gmail.com
15	Khushi Rajiv Pali	8767607224	palikhushi4@gmail.com
16	Tejas Rajesh Chelmeelwar	9604662119	tejaschelmeelwar@gmail.com
17	Khushbu Rajiv Pali	8459565214	palikhushbu59@gmail.com
18	Vineet Mukesh Singh	9766035354	vineetsingh3533@gmail.com
19	Yogita Jaysing Karemore	8381045307	swara.karemore25@gmail.com

Name & Signature of Teacher In-Charge

Prof. Pitambar Humane
IQAC Coordinator

CO ORDINATOR
INTERNAL QUALITY ASSURANCE CELL
DHARAMPETH, M. P. DEO MEMORIAL &
SCIENCE COLLEGE, NAGPUR

Name & Signature of Head of the Department

Department of Electronics
Dharampeth M.P. Deo Memorial
Science College, Nagpur

Dr. Arunesh Peshwe
Principal
Principal

Dharampeth M.P. Deo Memorial
Science College, Nagpur.

CD4001BC/CD4011BC

Quad 2-Input NOR Buffered B Series Gate • Quad 2-Input NAND Buffered B Series Gate

General Description

The CD4001BC and CD4011BC quad gates are monolithic complementary MOS (CMOS) integrated circuits constructed with N- and P-channel enhancement mode transistors. They have equal source and sink current capabilities and conform to standard B series output drive. The devices also have buffered outputs which improve transfer characteristics by providing very high gain.

All inputs are protected against static discharge with diodes to V_{DD} and V_{SS} .

Features

- Low power TTL
- Fan out of 2 driving 74L compatibility or 1 driving 74LS
- 5V–10V–15V parametric ratings
- Symmetrical output characteristics
- Maximum input leakage 1 μ A at 15V over full temperature range

Ordering Code:

Order Number	Package Number	Package Description
CD4001BCM	M14A	14-Lead Small Outline Integrated Circuit (SOIC), JEDEC MS-120, 0.150" Narrow
CD4001BCSJ	M14D	14-Lead Small Outline Package (SOP), EIAJ TYPE II, 5.3mm Wide
CD4001BCN	N14A	14-Lead Plastic Dual-In-Line Package (PDIP), JEDEC MS-001, 0.300" Wide
CD4011BCM	M14A	14-Lead Small Outline Integrated Circuit (SOIC), JEDEC MS-120, 0.150" Narrow
CD4011BCN	N14A	14-Lead Plastic Dual-In-Line Package (PDIP), JEDEC MS-001, 0.300" Wide

Denote pins available in Tape and Reel. Specify by appending the suffix letter "X" to the ordering code.

Connection Diagrams

Pin Assignments for DIP, SOIC and SOP
CD4001BC

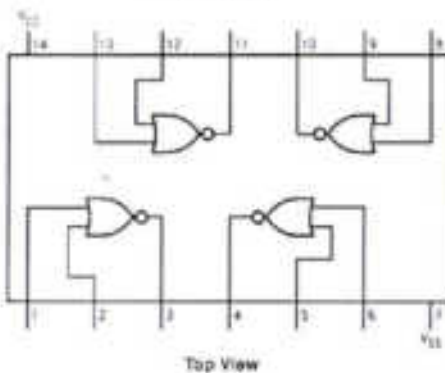

Pin Assignments for DIP and SOIC
CD4011BC

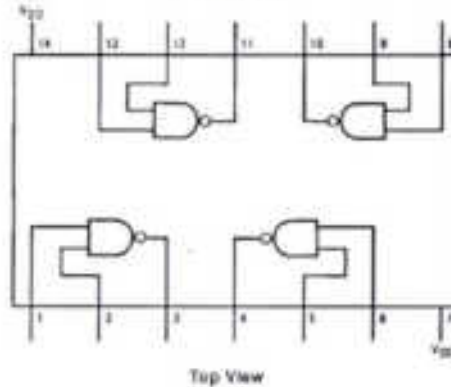

Absolute Maximum Ratings (Note 1)		Recommended Operating Conditions	
(Note 2)			
Voltage at any Pin	-0.5V to $V_{DD} + 0.5V$	Operating Range (V_{DD})	3 V_{DD} to 15 V_{DD}
Power Dissipation (P_D)		Operating Temperature Range	CD4001BC, CD4011BC: -40°C to +85°C
Dual-In-Line	700 mW	Note 1: Absolute Maximum Ratings are those values beyond which the safety of the device cannot be guaranteed. Except for Operating Temperature Range, they are not meant to imply that the devices should be operated at these levels. The Electrical Characteristics tables provide conditions for actual device operation.	
Small Outline	500 mW	Note 2: All voltages measured with respect to V_{SS} , unless otherwise specified.	
V_{DD} Range	-0.5 V_{DD} to +18 V_{DD}		
Storage Temperature (T_{STG})	-65°C to +150°C		
Lead Temperature (T_{LJ})			
(Soldering, 10 seconds)	260°C		

DC Electrical Characteristics (Note 3)

Symbol	Parameter	Conditions	40°C		25°C		85°C		Units	
			Min	Max	Min	Typ	Max	Min		Max
I_{DD}	Quiescent Device Current	$V_{DD} = 5V, V_{in} = V_{DD}$ or V_{SS}		1	0.304	1		1.5	μA	
		$V_{DD} = 10V, V_{in} = V_{DD}$ or V_{SS}		2	0.305	2		15	μA	
		$V_{DD} = 15V, V_{in} = V_{DD}$ or V_{SS}		4	0.308	4		30	μA	
V_{OL}	LOW Level Output Voltage	$V_{DD} = 5V$		0.05		0	0.05		0.05	V
		$V_{DD} = 10V, I_{OL} = 1 \mu A$		0.05		0	0.05		0.05	V
		$V_{DD} = 15V$		0.05		0	0.05		0.05	V
V_{OH}	HIGH Level Output Voltage	$V_{DD} = 5V$	4.95		4.95	5		4.95		V
		$V_{DD} = 10V, I_{OH} = 1 \mu A$	9.95		9.95	10		9.95		V
		$V_{DD} = 15V$	14.95		14.95	15		14.95		V
V_{IL}	LOW Level Input Voltage	$V_{DD} = 5V, V_{O} = 4.5V$		1.5		2	1.5		1.5	V
		$V_{DD} = 10V, V_{O} = 9.5V$		3.0		4	3.0		3.0	V
		$V_{DD} = 15V, V_{O} = 14.5V$		4.0		6	4.0		4.0	V
V_{IH}	HIGH Level Input Voltage	$V_{DD} = 5V, V_{O} = 0.5V$	1.5		3.5	3		2.5		V
		$V_{DD} = 10V, V_{O} = 1.0V$	3.0		7.0	6		5.0		V
		$V_{DD} = 15V, V_{O} = 1.5V$	4.5		11.0	9		7.5		V
I_{OL}	LOW Level Output Current (Note 3)	$V_{DD} = 5V, V_{O} = 0.4V$	0.52		0.44	0.68		0.36		mA
		$V_{DD} = 10V, V_{O} = 0.5V$	1.3		1.1	2.05		0.9		mA
		$V_{DD} = 15V, V_{O} = 1.0V$	3.0		3.0	4.8		2.4		mA
I_{OH}	HIGH Level Output Current (Note 3)	$V_{DD} = 5V, V_{O} = 4.6V$	-0.52		-0.44	-0.68		-0.36		mA
		$V_{DD} = 10V, V_{O} = 9.5V$	-1.3		-1.1	-2.05		-0.9		mA
		$V_{DD} = 15V, V_{O} = 14.5V$	-3.0		-3.0	-4.8		-2.4		mA
I_{in}	Input Current	$V_{DD} = 15V, V_{in} = 0V$		-1.30		-10 ⁻⁸	-0.30		-1.0	μA
		$V_{DD} = 15V, V_{in} = 15V$		0.30		10 ⁻⁸	0.30		1.0	μA

Note 3: I_{OL} and I_{OH} are tested one output at a time.

AC Electrical Characteristics (Note 4)

CD4001BC: $T_A = 25^\circ C$, Load $C_L = 20$ pF, $C_1 = 50$ pF, $R_1 = 200k$. Typical temperature coefficient is 0.3%/°C.

Symbol	Parameter	Conditions	Typ	Max	Units
t_{PLH}	Propagation Delay Time, HIGH-to-LOW Level	$V_{DD} = 5V$	120	250	ns
		$V_{DD} = 10V$	90	190	ns
		$V_{DD} = 15V$	35	70	ns
t_{PLL}	Propagation Delay Time, LOW-to-HIGH Level	$V_{DD} = 5V$	110	250	ns
		$V_{DD} = 10V$	90	190	ns
		$V_{DD} = 15V$	35	70	ns
t_{RHL}, t_{RHL}	Transition Time	$V_{DD} = 5V$	90	200	ns
		$V_{DD} = 10V$	50	100	ns
		$V_{DD} = 15V$	40	90	ns
C_{in}	Average Input Capacitance	Any Input	5	7.5	pF
C_{PD}	Power Dissipation Capacity	Any Gate	14		pF

Note 4: AC Parameters are guaranteed by DC correlated testing.

Typical Transfer Characteristics

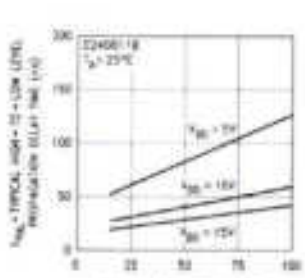
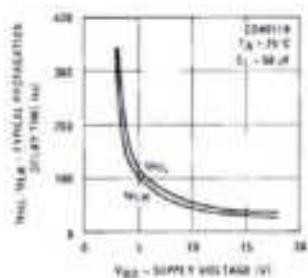
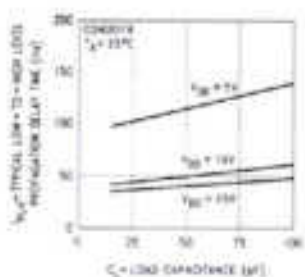
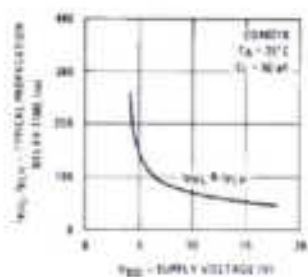
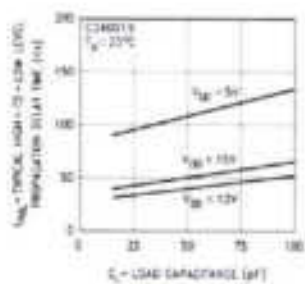
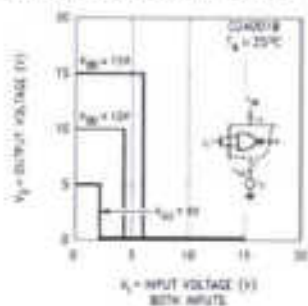

CD4001BC/CD4011BC

Physical Dimensions inches (millimeters) unless otherwise noted

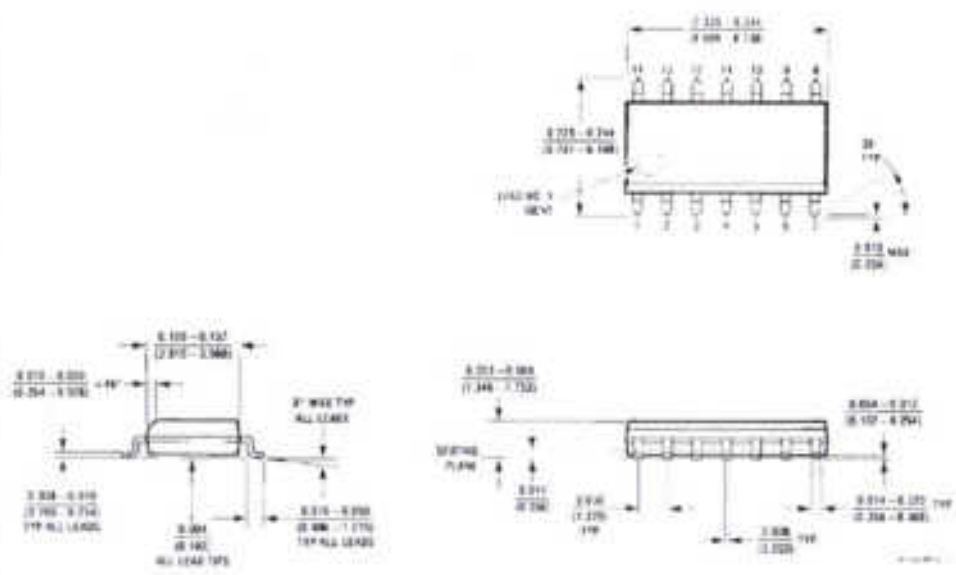

**14-Lead Small Outline Integrated Circuit (SOIC), JEDEC MS-120, 0.150" Narrow
Package Number M14A**

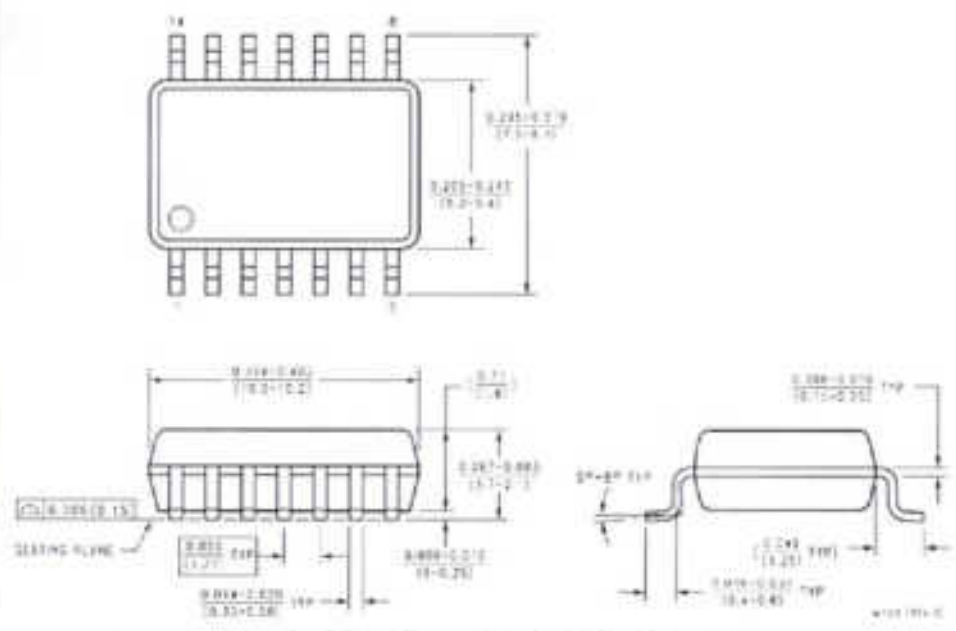

**14-Lead Small Outline Package (SOP), EIAJ TYPE II, 5.3mm Wide
Package Number M14D**

74HC00

Quad 2-Input NAND Gate

High-Performance Silicon-Gate CMOS

The 74HC00 is identical in pinout to the LS00. The device inputs are compatible with Standard CMOS outputs; with pullup resistors, they are compatible with LSTTL outputs.

Features

- Output Drive Capability: 10 LSTTL Loads
- Outputs Directly Interface to CMOS, NMOS and TTL
- Operating Voltage Range: 2.0 to 6.0 V
- Low Input Current: 1.0 μ A
- High Noise Immunity Characteristic of CMOS Devices
- In Compliance With the JEDEC Standard No. 7A Requirements
- ESD Performance: HBM > 2000 V, Machine Model > 200 V
- Chip Complexity: 32 FETs or 8 Equivalent Gates
- These are Pb-Free Devices

LOGIC DIAGRAM

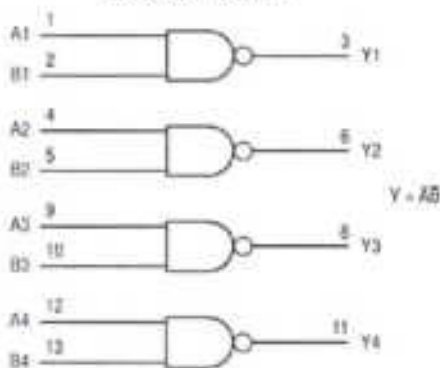

Pin 14 = V_{CC}
Pin 7 = GND

Pinout: 14-Lead Packages (Top View)

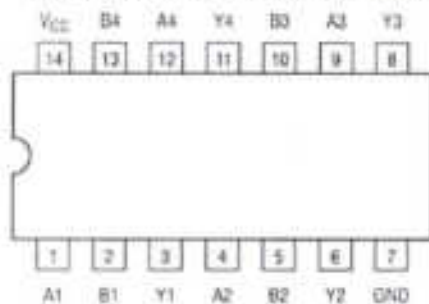

ON Semiconductor®

<http://onsemi.com>

MARKING DIAGRAMS

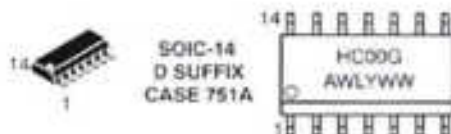

SOIC-14
D SUFFIX
CASE 751A



TSSOP-14
DT SUFFIX
CASE 949G

HC00 = Device Code
A = Assembly Location
WL or L = Water Lot
Y = Year
WW or W = Work Week
G or • = Pb-Free Package

(Note: Microdot may be in either location)

FUNCTION TABLE

Inputs		Output
A	B	Y
L	L	H
L	H	H
H	L	H
H	H	L

ORDERING INFORMATION

See detailed ordering and shipping information in the package dimensions section on page 2 of this data sheet.

74HC00

DC CHARACTERISTICS (Voltages Referenced to GND)

Symbol	Parameter	Condition	V _{CC} (V)	Guaranteed Limit			Unit
				-55 to 25°C	+85°C	+125°C	
V _{ih}	Minimum High-Level Input Voltage	V _{out} = 0.1V or V _{CC} - 0.1V I _{out} = 20µA	2.0	1.50	1.50	1.50	V
			3.0	2.10	2.10	2.10	
			4.5	3.15	3.15	3.15	
			6.0	4.20	4.20	4.20	
V _{il}	Maximum Low-Level Input Voltage	V _{out} = 0.1V or V _{CC} - 0.1V I _{out} = 20µA	2.0	0.50	0.50	0.50	V
			3.0	0.90	0.90	0.90	
			4.5	1.35	1.35	1.35	
			6.0	1.80	1.80	1.80	
V _{oh}	Minimum High-Level Output Voltage	V _{in} = V _{ih} or V _{il} I _{out} = 20µA	2.0	1.9	1.9	1.9	V
			4.5	4.4	4.4	4.4	
			6.0	5.9	5.9	5.9	
		V _{in} = V _{ih} or V _{il} I _{out} = 2.4mA I _{out} = 4.0mA I _{out} = 5.2mA	3.0	2.48	2.34	2.20	
			4.5	3.98	3.84	3.70	
			6.0	5.48	5.34	5.20	
V _{ol}	Maximum Low-Level Output Voltage	V _{in} = V _{ih} or V _{il} I _{out} = 20µA	2.0	0.1	0.1	0.1	V
			4.5	0.1	0.1	0.1	
			6.0	0.1	0.1	0.1	
		V _{in} = V _{ih} or V _{il} I _{out} = 2.4mA I _{out} = 4.0mA I _{out} = 5.2mA	3.0	0.26	0.33	0.40	
			4.5	0.26	0.33	0.40	
			6.0	0.26	0.33	0.40	
I _{in}	Maximum Input Leakage Current	V _{in} = V _{CC} or GND	6.0	±0.1	±1.0	±1.0	µA
I _{CC}	Maximum Quiescent Supply Current (per Package)	V _{in} = V _{CC} or GND I _{out} = 0µA	6.0	2.0	20	40	µA

NOTE: Information on typical parametric values can be found in Chapter 2 of the ON Semiconductor High-Speed CMOS Data Book (DL129/D).

AC CHARACTERISTICS (C_L = 50 pF, Input t_r = t_f = 6 ns)

Symbol	Parameter	V _{CC} (V)	Guaranteed Limit			Unit
			-55 to 25°C	+85°C	+125°C	
t _{PLH} t _{PLH}	Maximum Propagation Delay, Input A or B to Output Y (Figures 1 and 2)	2.0	75	95	110	ns
		3.0	30	40	55	
		4.5	15	19	22	
		6.0	13	16	19	
t _{ELH} t _{ELH}	Maximum Output Transition Time, Any Output (Figures 1 and 2)	2.0	75	95	110	ns
		3.0	27	32	36	
		4.5	15	19	22	
		6.0	13	16	19	
C _{in}	Maximum Input Capacitance		10	10	10	pF

NOTE: For propagation delays with loads other than 50 pF, and information on typical parametric values, see Chapter 2 of the ON Semiconductor High-Speed CMOS Data Book (DL129/D).

C _{PD}	Power Dissipation Capacitance (Per Buffer)*	Typical @ 25°C, V _{CC} = 5.0 V, V _{EE} = 0 V		pF
		22		

* Used to determine the no-load dynamic power consumption: P_D = C_{PD} V_{CC}²f + I_{CC} V_{CC}. For load considerations, see Chapter 2 of the ON Semiconductor High-Speed CMOS Data Book (DL129/D).

74HC00

PACKAGE DIMENSIONS

SOIC-14
CASE 751A-03
ISSUE H

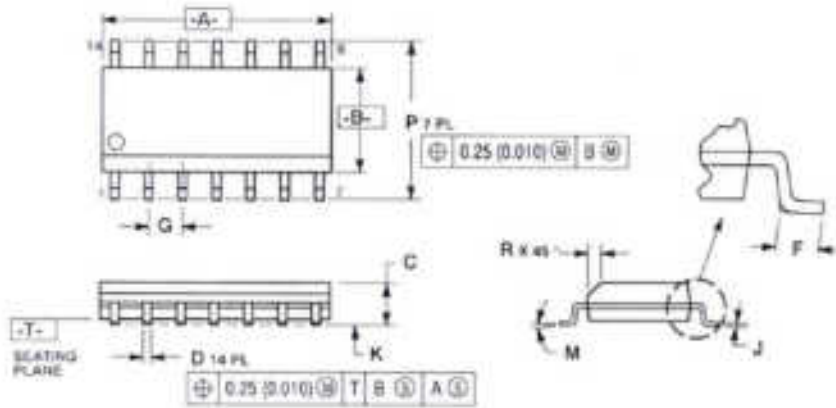

NOTES

1. DIMENSIONING AND TOLERANCING PER ANSI Y14.5M, 1982.
2. CONTROLLING DIMENSION: MILLIMETER.
3. DIMENSIONS A AND B DO NOT INCLUDE MOLD PROTRUSION.
4. MAXIMUM MOLD PROTRUSION: 0.15 (0.006) PER SIDE.
5. DIMENSION D DOES NOT INCLUDE DAMBAR PROTRUSION. ALLOWABLE DAMBAR PROTRUSION SHALL BE 0.127 (0.005) TOTAL IN EXCESS OF THE D DIMENSION AT MAXIMUM MATERIAL CONDITION.

DIM	MILLIMETERS		INCHES	
	MIN	MAX	MIN	MAX
A	8.55	8.75	0.337	0.344
B	3.80	4.00	0.150	0.157
C	1.25	1.75	0.050	0.069
D	0.25	0.49	0.010	0.019
F	0.40	1.25	0.016	0.049
G	1.27 BSC		0.050 BSC	
J	0.13	0.25	0.005	0.010
K	0.10	0.25	0.004	0.010
M	0 [*]	0 [*]	0 [*]	0 [*]
P	3.80	4.20	0.150	0.165
H	0.25	0.50	0.010	0.019

SOLDERING FOOTPRINT*

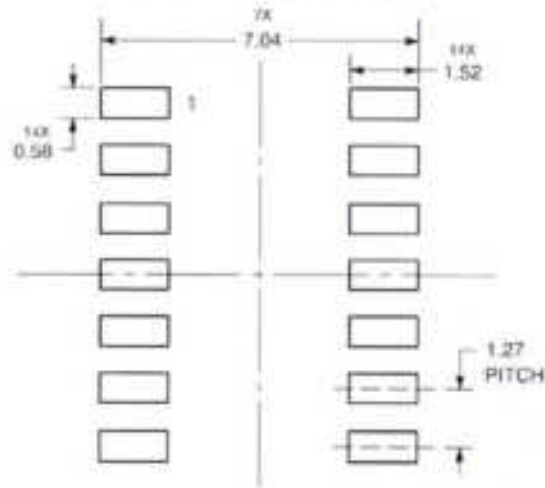

DIMENSIONS: MILLIMETERS

*For additional information on our Pb-Free strategy and soldering details, please download the ON Semiconductor Soldering and Mounting Techniques Reference Manual, SOLDERRM/D.

74HC00

PACKAGE DIMENSIONS

TSSOP-14
CASE 948G-01
ISSUE B

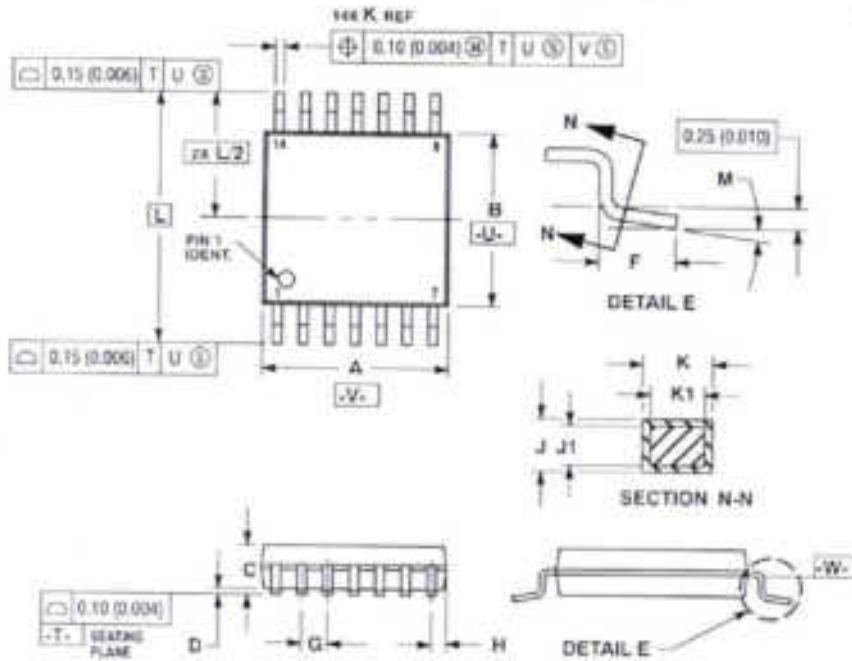

NOTES

1. DIMENSIONING AND TOLERANCING PER ANSI Y14.5M, 1982
2. CONTROLLING DIMENSION: MILLIMETER
3. DIMENSION A DOES NOT INCLUDE MOLD FLASH, PROTRUSIONS OR GATE BURRS. MOLD FLASH OR GATE BURRS SHALL NOT EXCEED 0.15 (0.006) PER SIDE.
4. DIMENSION B DOES NOT INCLUDE INTERLEAD FLASH OR PROTRUSION. INTERLEAD FLASH OR PROTRUSION SHALL NOT EXCEED 0.25 (0.010) PER SIDE.
5. DIMENSION K DOES NOT INCLUDE DAMBAR PROTRUSION. ALLOWABLE DAMBAR PROTRUSION SHALL BE 0.08 (0.003) TOTAL IN EXCESS OF THE K DIMENSION AT MAXIMUM MATERIAL CONDITION.
6. TERMINAL NUMBERS ARE SHOWN FOR REFERENCE ONLY.
7. DIMENSION A AND B ARE TO BE DETERMINED AT DATUM PLANE W.

DIM	MILLIMETERS		INCHES	
	MIN	MAX	MIN	MAX
A	4.90	5.10	0.193	0.200
B	4.30	4.50	0.169	0.177
C	—	1.25	—	0.049
D	0.05	0.18	0.002	0.006
F	0.30	0.75	0.012	0.030
G	0.65 BSC	—	0.026 BSC	—
H	0.30	0.80	0.012	0.031
J	0.09	0.25	0.004	0.010
J1	0.09	0.18	0.004	0.006
K	0.19	0.20	0.007	0.012
K1	0.19	0.25	0.007	0.010
L	0.40 BSC	—	0.016 BSC	—
M	0°	8°	0°	8°

SOLDERING FOOTPRINT*

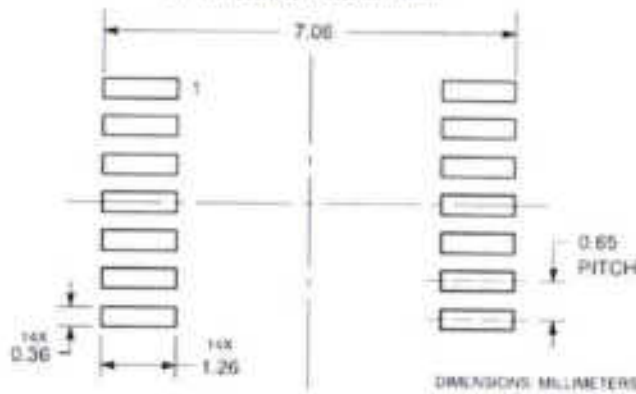

*For additional information on our Pb-Free strategy and soldering details, please download the ON Semiconductor Soldering and Mounting Techniques Reference Manual, SOLDERRM/D.

74HC00

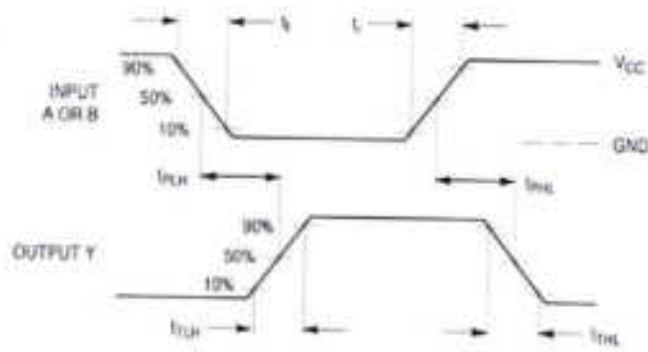
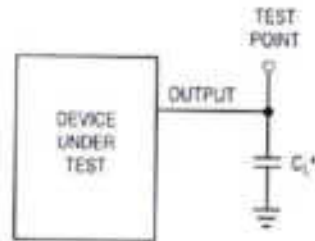

Figure 1. Switching Waveforms



*Includes all probe and jig capacitance

Figure 2. Test Circuit



Figure 3. Expanded Logic Diagram
(1/4 of the Device)

74HC00

MAXIMUM RATINGS

Symbol	Parameter	Value	Unit
V_{CC}	DC Supply Voltage (Referenced to GND)	- 0.5 to + 7.0	V
V_{in}	DC Input Voltage (Referenced to GND)	- 0.5 to $V_{CC} + 0.5$	V
V_{out}	DC Output Voltage (Referenced to GND)	- 0.5 to $V_{CC} + 0.5$	V
I_{in}	DC Input Current, per Pin	+20	mA
I_{out}	DC Output Current, per Pin	+25	mA
I_{CC}	DC Supply Current, V_{CC} and GND Pins	+50	mA
P_D	Power Dissipation in Still Air, SOIC Package† TSSOP Package†	500 450	mW
T_{stg}	Storage Temperature	- 65 to + 150	°C
T_L	Lead Temperature, 1 mm from Case for 10 s SOIC or TSSOP Package	260	°C

This device contains protection circuitry to guard against damage due to high static voltages or electric fields. However, precautions must be taken to avoid applications of any voltage higher than maximum rated voltages to this high-impedance circuit. For proper operation, V_{in} and V_{out} should be constrained to the range $GND \leq (V_{in} \text{ or } V_{out}) \leq V_{CC}$. Unused inputs must always be tied to an appropriate logic voltage level (e.g., either GND or V_{CC}). Unused outputs must be left open.

Stresses exceeding Maximum Ratings may damage the device. Maximum Ratings are stress ratings only. Functional operation above the Recommended Operating Conditions is not implied. Extended exposure to stresses above the Recommended Operating Conditions may affect device reliability.

†Dorating — SOIC Package: - 7 mW/°C from 65° to 125°C
TSSOP Package: - 6.1 mW/°C from 65° to 125°C

For high frequency or heavy load considerations, see Chapter 2 of the ON Semiconductor High-Speed CMOS Data Book (DL129/D).

RECOMMENDED OPERATING CONDITIONS

Symbol	Parameter	Min	Max	Unit	
V_{CC}	DC Supply Voltage (Referenced to GND)	2.0	6.0	V	
V_{in}, V_{out}	DC Input Voltage, Output Voltage (Referenced to GND)	0	V_{CC}	V	
T_A	Operating Temperature, All Package Types	- 55	+ 125	°C	
t_r, t_f	Input Rise and Fall Time (Figure 1)	$V_{CC} = 2.0\text{ V}$ $V_{CC} = 4.5\text{ V}$ $V_{CC} = 6.0\text{ V}$	0 0 0	1000 500 400	ns

ORDERING INFORMATION

Device	Package	Shipping [†]
74HC00DR2G	SOIC-14 (Pb-Free)	2500/Tape & Reel
74HC00DTR2G	TSSOP-14*	

†For information on tape and reel specifications, including part orientation and tape sizes, please refer to our Tape and Reel Packaging Specifications Brochure, BRD8011/D.

*This package is inherently Pb-Free.

Physical Dimensions inches (millimeters) unless otherwise noted (Continued)

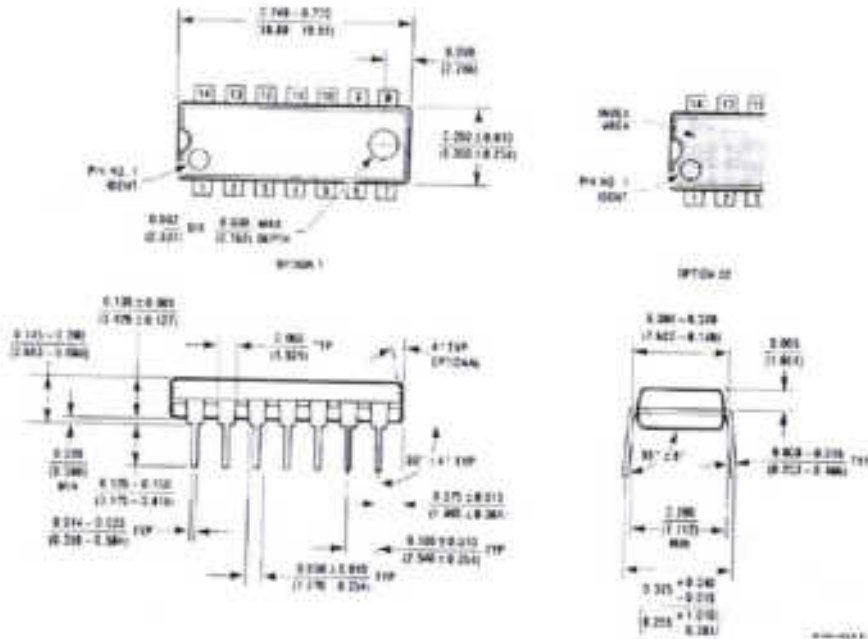

14-Lead Plastic Dual-In-Line Package (PDIP), JEDEC MS-001, 0.300" Wide
Package Number N14A

LIFE SUPPORT POLICY

FAIRCHILD'S PRODUCTS ARE NOT AUTHORIZED FOR USE AS CRITICAL COMPONENTS IN LIFE SUPPORT DEVICES OR SYSTEMS WITHOUT THE EXPRESS WRITTEN APPROVAL OF THE PRESIDENT OF FAIRCHILD SEMICONDUCTOR CORPORATION. As used herein:

1. Life support devices or systems are devices or systems which: (a) are intended for surgical implant into the body, or (b) support or sustain life, and (c) whose failure to perform when properly used in accordance with instructions for use provided in the labeling, can be reasonably expected to result in a significant injury to the user.
2. A critical component in any component of a life support device or system whose failure to perform can be reasonably expected to cause the failure of the life support device or system, or to affect its safety or effectiveness.

www.fairchildsemi.com

©2002 Fairchild Semiconductor Corporation. All rights reserved. This document is the property of Fairchild Semiconductor Corporation. All other trademarks are the property of their respective owners.

CD4001BC/CD4011BC

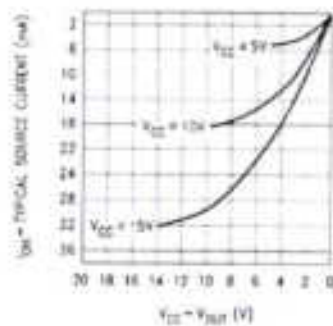
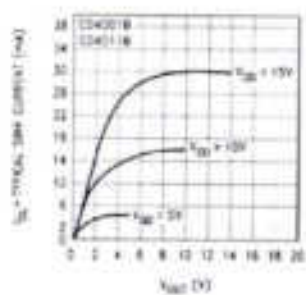
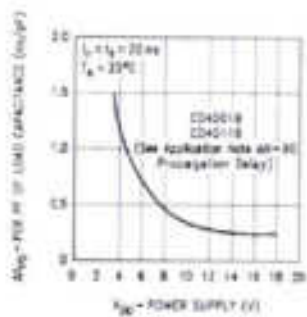
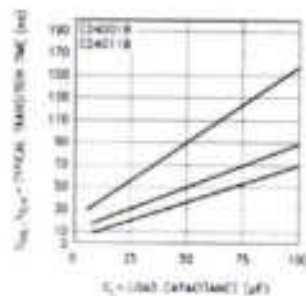
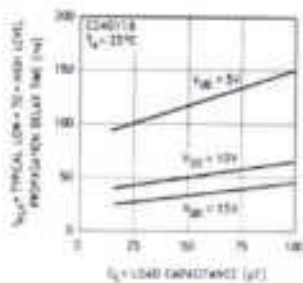

CD4001BC/CD4011BC

AC Electrical Characteristics (Note 5)

CD4011BC, $T_A = 25^\circ\text{C}$, Input $L_1 = 20\text{ nF}$, $C_L = 50\text{ pF}$, $R_L = 200\text{ k}\Omega$, Typical Temperature Coefficient is $\pm 0.3\%/^\circ\text{C}$

Symbol	Parameter	Conditions	Typ	Max	Units
t_{PLH}	Propagation Delay HIGH to LOW Level	$V_{DD} = 5\text{V}$	120	250	ns
		$V_{DD} = 10\text{V}$	50	100	ns
		$V_{DD} = 15\text{V}$	35	70	ns
t_{PLL}	Propagation Delay LOW to HIGH Level	$V_{DD} = 5\text{V}$	80	250	ns
		$V_{DD} = 10\text{V}$	40	100	ns
		$V_{DD} = 15\text{V}$	30	70	ns
t_{rHL}, t_{rLH}	Transition Time	$V_{DD} = 5\text{V}$	90	200	ns
		$V_{DD} = 10\text{V}$	50	100	ns
		$V_{DD} = 15\text{V}$	40	80	ns
C_{in}	Average Input Capacitance	Any Input	5	7.5	pF
C_{out}	Power Dissipation Capacity	Any Gate	10		mW

Note 5: AC Parameters are guaranteed by DC parameter testing.

Typical Performance Characteristics

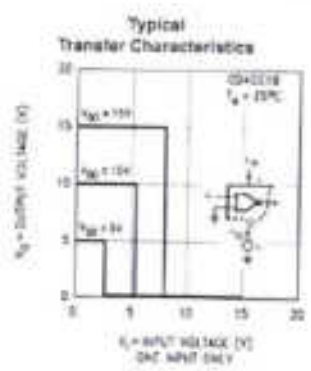
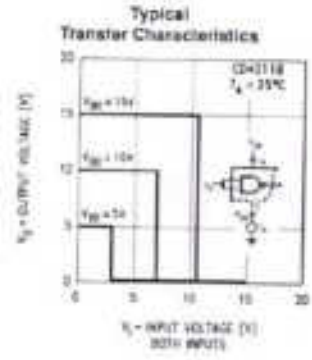
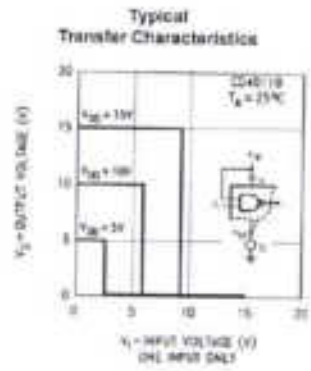

Schematic Diagrams

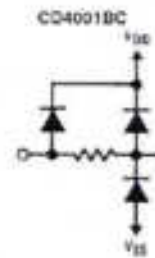
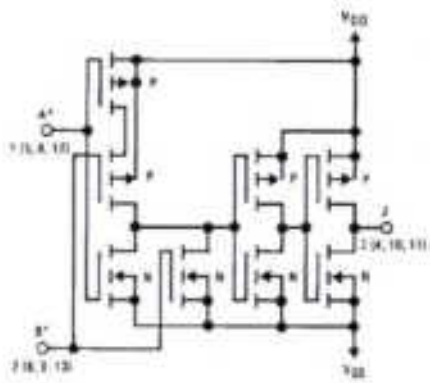

t_{pd} of device shown
 $\approx 37\text{ns}$
 Logic '1' = HIGH
 Logic '0' = LOW
 All inputs protected by standard
 CMOS protection circuit.

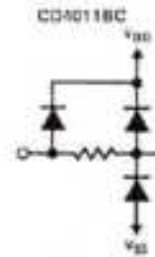
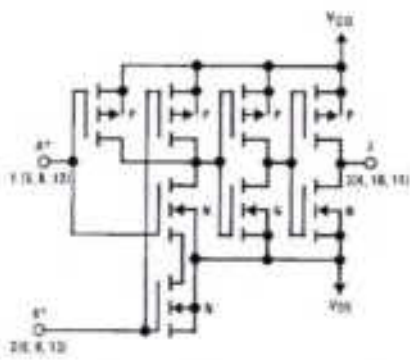

t_{pd} of device shown
 $\approx 37\text{ns}$
 Logic '1' = HIGH
 Logic '0' = LOW
 All inputs protected by standard
 CMOS protection circuit.



DHARAMPETH M. P. DEO MEMORIAL SCIENCE COLLEGE, NAGPUR
INTERNAL QUALITY ASSURANCE CELL (IQAC)

Activity Report

Date: 11.03.2023

Name of Organizing Department or Committee: Dept. of Home Science

Name of the activity: Discussion on risk factors of Lifestyle diseases for self. (NEP 2022 Activity)

Suggested CRITERION point if any:

Date of Activity: 11.03.2023

Place of Activity: Classroom, Dept. of Home Science

Name of Guest Speaker/s or Judge/s or Chief Guest/s if any:

Title of the Activity: Discussion on risk factors of Lifestyle diseases for self

Number of Participants: 10

Activity Report

Name of the Teacher In-charge / Convener: Mrs. Meghna Pandit

Names of other Committee Members / Staff:

OUTCOME of the Activity with respect to mission vision of the institute and or academics:

To create awareness regarding risk factors of lifestyle diseases by evaluation of daily habits of students.

Activity with newspaper coverage if any:

Activity data save in PC of: _____

Note: Kindly share geotag photographs separately along with report on iqacdsc2022@gmail.com

Prof. Pitambar Humane
IQAC Coordinator

CO ORDINATOR
INTERNAL QUALITY ASSURANCE CELL
DHARAMPETH, M. P. DEO MEMORIAL &
SCIENCE COLLEGE, NAGPUR

Name & Signature of Teacher In-charge
(Mrs. Meghna Pandit)

Dr. Akhilesh Peshwe
PRINCIPAL
Dharampeth M. P. Deo Memorial
Science College, Nagpur-440033





DHARAMPETH M. P. DEO MEMORIAL SCIENCE COLLEGE,
North Ambazari Road, Near Ambazari Lake, Nagpur-440033

DATA VALIDATION & VERIFICATION (DVV)

Name of the Programme : Discussion on risk factors of lifestyle diseases
Date of the Programme : 11/03/2023
Name of Chief Guest if any : _____
Name of Guest Speaker if any : _____

Sr. No.	Name of the Participant	Mobile Number	E-mail id	Signature
1	Ananya A. Meghze	9284834489	ananyaamgheze@gmail.com	Ananya
2	Sushmita Mallick	983791660	sushmita00@gmail.com	Sushmita
3	Moyuni Mali	7498065023	moyunimali18@gmail.com	Moyuni
4	Nahina Wankhede	7821883251	nahinawankhede7@gmail.com	Nahina
5	Vaishnavi Upasak	9975227431	upasak.vaishnavi@gmail.com	Vupasak
6	Renuka Raut	8855972285	rautrrenuka85@gmail.com	Renuka
7	Sakshi Thosar	8177911360	sakshithosar2620@gmail.com	SThosar
8	Vaishnavi Bahadure	9284679244	vaishnavibahadure34@gmail.com	Vaishnavi
9	Purnali Raut	9130117015	Purnaliraut537@gmail.com	Purnali
10	Vanshika Todase	7447275658	vanshikatodase@gmail.com	Vanshika

Signature of:

Programme In-charge

(Mrs Meghna Pandit)

COORDINATOR
INTERNAL QUALITY ASSURANCE CELL
DHARAMPETH, M. P. DEO MEMORIAL &
SCIENCE COLLEGE, NAGPUR

PRINCIPAL
Dharampeth M. P. Deo Memorial
Science College, Nagpur-440033



DHARAMPETH M. P. DEO MEMORIAL SCIENCE COLLEGE, NAGPUR
INTERNAL QUALITY ASSURANCE CELL (IQAC)

Activity Report (NEP: 2022-23)

Date: 30/03/23

Name of Organizing Department or Committee: Zoology
Name of the activity: Model preparation of Griffiths experiment of bacterial transformation
Suggested CRITERION point if any: Criteria I
Date of Activity: 11/03/2023
Place of Activity: Zoology Laboratory
Name of Guest Speaker judge/s or Chief Guest/s if any: No
Title of the Activity: Model preparation of Griffiths experiment of bacterial transformation
Number of Participants: 21
Name of the Teacher In-charge / Convener: Dr. Snehal Dapke
Names of other Committee Members / Staff:
OUTCOME of the Activity with respect to mission vision of the institute and or academics:

- 1) Model making practice improves mental functioning.
- 2) It boosts thinking capacity and perform analysing skills.
- 3) It improves cooperation and imagination skill among student.
- 4) Student actively participate and understand the topic effectively

Activity with newspaper coverage if any: NIL
Activity data save in PC of: Zoology Department/personal laptop



Prof. Pitambar Humane
IQAC Coordinator

CO ORDINATOR
INTERNAL QUALITY ASSURANCE CELL
DHARAMPETH, M. P. DEO MEMORIAL &
SCIENCE COLLEGE, NAGPUR

Name & Signature of Teacher In-charge

Dr. Akhilesh Peshwe
Principal
Principal

Dharampeth M. P. Deo Memorial
 Science College, NAGPUR



DHARAMPETH M. P. DEO MEMORIAL SCIENCE COLLEGE,

North Ambazari Road, Near Ambazari Lake, Nagpur-440033

DATA VALIDATION & VERIFICATION (DVV)

Griffith's experiment of Bacterial Transformation - 11/3/2023

Sr. No.	Name of the Participant	Mobile Number	E-mail Id	Signature
1)	Urmila V. Bhandar	9570643864	bhandarurmila2002@gmail.com	
2)	Shreya Dhowale	8888264004	shreyadhowale184@gmail.com	
3)	Vaibhavi Shinde	8080640482	Vaibhavisinde99@gmail.com	
4)	Vaishnavi Lakhe	8669594864	chhatkuli.lakhe53@gmail.com	
5)	Tina Rahangdale	9921776769	TinaRahangdale@gmail.com	
6)	Anjali Mishra	9325604513	anjalmishra4954@gmail.com	
7)	Vaishnavi Mandapure	9322439316	Vaishnavimandapure8@gmail.com	
8)	Shrawani Warkhede	7058368837	shrawaniwarkhede@gmail.com	
9)	Priyanka Lakhande	8149176609	twinklakkhande14@gmail.com	
10)	Pooja Tankar	9156973252	poojatankar987@gmail.com	
11)	Niket Thakur	7378899087	niketthakur82@gmail.com	
12)	Rupesh Bhokre	8805887370	bhokrerupesh@gmail.com	
13)	Surbhishi Pawar	7887516628	Surbhishipawar678@gmail.com	
14)	Siddhant G. Hirkane	9579092931	hirkane.siddhant1234@gmail.com	
15)	Kalpna D. Suhagpure	9579236712	KalpnaD.suhagpure7@gmail.com	
16)	Rohit Pawar	9373097285		
17)	Shamal Natar			
18)	Tejas Rewade	7796027056		
19)	Chhatkuli Wadhikar	9325047907		

Signature of:

Programme In-charge

CO ORDINATOR

INTERNATIONAL INSURANCE CELL
DHARAMPETH, M. P. DEO MEMORIAL &
SCIENCE COLLEGE, NAGPUR

Principal

Dharampeth M. P. Deo Memorial
Science College, NAGPUR



DHARAMPETH M. P. DEO MEMORIAL SCIENCE COLLEGE, NAGPUR
INTERNAL QUALITY ASSURANCE CELL (IQAC)

Activity Report (NEP: 2022-23)

Date: 31/03/23

Name of Organizing Department or Committee: Zoology

Name of the activity: Group discussion on multiple choice questions on topic Antigen-antibody interaction.

Suggested CRITERION point if any: Criteria I

Date of Activity: 11/03/2023

Place of Activity: Class room 104

Name of Guest Speaker judge/s or Chief Guest/s if any:

Title of the Activity: Group discussion on multiple choice questions on topic Antigen-antibody interaction.

Number of Participants: 16

Name of the Teacher In-charge / Convener: Dr. D. P. Singh

Names of other Committee Members / Staff:

OUTCOME of the Activity with respect to mission vision of the institute and or academics:

- 1) Group discussions promote a deeper understanding of a topic and increase long-term retention.
- 2) Group discussions can also help increase participants' attention and help maintain their focus by involving them in the learning process.
- 3) Students learn to share their views in front of people with facts and figures.
- 4) This activity helps student in generating more ideas about topic

Activity with newspaper coverage if any: NIL

Activity data save in PC of: Zoology Department/personal laptop



(Handwritten signature of Prof. Pitambar Humane)

Prof. Pitambar Humane

IQAC Coordinator
CO ORDINATOR

INTERNAL QUALITY ASSURANCE CELL
DHARAMPETH, M. P. DEO MEMORIAL &
SCIENCE COLLEGE, NAGPUR

(Handwritten signature of Dr. Dharmendra Singh)

Name & Signature of Teacher In-charge

(Handwritten signature of Dr. Akhilesh Peshwe)

Dr. Akhilesh Peshwe

Principal

Principal

Dharampeth M. P. Deo Memorial
Science College, NAGPUR

Timestamp	Email Address	Score	Name (Name and Surname)	Batch
3/11/2023 13:58:27	jyotis8390@gmail.com	7 / 20	Jyoti Sharma	F-15
3/11/2023 14:04:07	abhishekdeshbhratar86@gmail.cc	5 / 20	Abhishek Diwakar Deshbhratar	F-11
3/11/2023 14:04:37	shreyadhawale124@gmail.com	16 / 20	Shreya sunil Dhawale	F-14
3/11/2023 14:04:37	kalpanasuhagpure7@gmail.com	5 / 20	Kalpana suhagpure	F-14
3/11/2023 14:04:51	jagrutiajlrawat58@gmail.com	9 / 20	Jagruiti Ajit rawat	F-11
3/11/2023 14:04:53	bedadevaishnavi1@gmail.com	13 / 20	Vaishnavi Bedade	F-15
3/11/2023 14:05:15	bondreurmila.2000@gmail.com	15 / 20	Urmila bondre	F-14
3/11/2023 14:05:56	vaibhavishende97@gmail.com	16 / 20	Vaibhavi Shende	F-14
3/11/2023 14:06:01	jagrutiwarkar09@gmail.com	18 / 20	Jagruiti Dhanraj warkar	F-15
3/11/2023 14:06:02	amandongre2003@gmail.com	17 / 20	AMAN ANIL DONGRE	F-15
3/11/2023 14:06:11	bhokrerupesh@gmail.com	13 / 20	Rupesh Bhokre	F-14
3/11/2023 14:06:31	hirkanesiddharh1234@gmail.com	10 / 20	Siddharth hirkane	F-14
3/11/2023 14:06:38	deulkaraditya27@gmail.com	14 / 20	Aditya Gajanan Deulkar	F-11
3/11/2023 14:06:48	mishraankita4683@gmail.com	9 / 20	Ankita Mishra	F-11
3/11/2023 14:06:55	asmitaچارجان25@gmail.com	8 / 20	Asmita charjan	F-11
3/11/2023 14:07:04	mansi19182@gmail.com	16 / 20	Mansi ishwar mate	F-15
3/11/2023 14:07:31	chaudharijuhi120@gmail.com	12 / 20	JUHI CHAUDHARI	F-15
3/11/2023 14:08:20	niketthakre82@gmail.com	15 / 20	Niket Yuvraj Thakre	F-14

**DHARAMPETH M. P. DEO MEMORIAL SCIENCE COLLEGE,**

North Ambazari Road, Near Ambazari Lake, Nagpur- 440033

DATA VALIDATION & VERIFICATION (DVV)

Name of the Programme : Antigen - Antibody interaction model unit 3 Paper II of Sem IV
Date of the Programme : on 11/03/2023
Name of Chief Guest if any : _____
Name of Guest Speaker if any : _____

Sr. No.	Name of the Participant	Mobile Number	E-mail Id	Signature
1.	Urmila V. Bordar	9370673867	boardarmila.2000@gmail.com	
2.	Shreyas Dhawale	8888264004	ShreyasDhawale.124@gmail.com	
3.	Yashvati Shende	9080640782	YashvatiShende91@gmail.com	
4.	Yashnavi J. Bedade	9830107397	bedadeyashnavi@gmail.com	
5.	AMAN. A. DONGRE	7709217312	amandongre2003@gmail.com	
6.	Jagauti D. Warkar	7447366023	jagauti.warkar09@gmail.com	
7.	Mansi J. Mate	8468891807	Mansi19182@gmail.com	
8.	Niket V. Thakur	7378899087	niket.thakur52@gmail.com	
9.	Aditya A. Dalkar	9028915776	aditya.dalkar27@gmail.com	
10.	Rupesh Bhokre	8805887370	bhokrerupesh@gmail.com	
11.	Jyoti J. Sharma	8669736390	jyoti58290@gmail.com	
12.	Prithvish G. Hirkan	9579092931	prithvishg.hirkan@gmail.com	
13.	Kalpna Suhagpure	3579236712	kalpanasuhagpure@gmail.com	
14.	Asmita Chhajjan	7387008732	asmitachhajjan25@gmail.com	

Signature of:
Programme In-charge

IQAC Coordinator
CO ORDINATOR
INTERNAL QUALITY ASSURANCE CELL
DHARAMPETH, M. P. DEO MEMORIAL &
SCIENCE COLLEGE, NAGPUR

Principal
Principal
Dharampeth M. P. Deo Memorial
Science College, Nagpur



DHARAMPETH M. P. DEO MEMORIAL SCIENCE COLLEGE, NAGPUR
INTERNAL QUALITY ASSURANCE CELL (IQAC)
NEP Activity Report

Date : 28/3/23

Name of Organizing Department or Committee: Department of Chemistry

Name of the activity: NEP Activity Home science Sem IV Unit II

Suggested CRITERION point if any: Criteria II

Date of Activity: 11/3/2023.

Place of Activity: Home Science Department 2nd floor

Name of Guest Speaker/s or Judge/s or Chief Guest/s if any: Nil

Title of the Activity: Group discussion on hazards of synthetic perfumes and attars

Number of Participants: 10

Name of the Teacher In-charge / Convener: Dr. Sandip Madhukar Bhiwagade

Names of other Committee Members / Staff: Dr. Vaishali P. Meshram

OUTCOME of the Activity with respect to mission vision of the institute and or academics:

This activity helps to understand students how synthetic perfumes and attars are made in industry. What are the symptoms of allergy caused by chemicals used in making perfumes and attars. What are the health hazards caused by perfumes and attars. How to test suitable perfumes or attars which are suitable for individuals.

Activity with newspaper coverage if any : Nil

Activity data save in PC of: Department of Chemistry



Dr. Sandip Bhiwagade
SB

Name & Signature of Teacher In-charge

Prof. Pitambar Humane
IQAC Coordinator

CO ORDINATOR
INTERNAL QUALITY ASSURANCE CELL
DHARAMPETH, M. P. DEO MEMORIAL &
SCIENCE COLLEGE, NAGPUR

Dr. Akhilesh Peshwe
Principal

PRINCIPAL
Dharampeth M.P. Deo Memorial
Science College, Nagpur-440033



DHARAMPETH M. P. DEO MEMORIAL SCIENCE COLLEGE,
North Ambazari Road, Near Ambazari Lake, Nagpur-440033

DATA VALIDATION & VERIFICATION (DVV)

Name of the Programme : Group discussion on Hazards of synthetic perfumes & attars
Date of the Programme : 11/3/2023
Name of Chief Guest if any : _____
Name of Guest Speaker if any : _____

Sr. No.	Name of the Participant	Mobile Number	E-mail id	Signature
1	Pragya S. Thuan	6394098386	Pragyathuan19052001@gmail.com	
2	Anushi Shermali	9096507459	Anushishermali15@gmail.com	
3	Ojasi Wankhede	8767699751	wankhedeojasi@gmail.com	
4	Prachi N. Lanekar	8806244419	prachilanekar15@gmail.com	
5	Pallavi B. Patre	8459277408	patre573@gmail.com	
6	Pranali Ghongarkar	9309079427	Pranali02gh@gmail.com	
7	Sujata Kawre	9175451202	Sujatakawre1@gmail.com	
8	Bhagyashree S. Ambule	9359139068	ambuleb667@gmail.com	
9	Tannu S. Korde	7841984450	Kordetannu13@gmail.com	
10	Kimaya Kale	8866013792	Kimayakale03@gmail.com	

Signature of:

Programme In-charge

IQAC Coordinator

INTERNAL QUALITY ASSURANCE CELL
DHARAMPETH, M. P. DEO MEMORIAL &
SCIENCE COLLEGE, NAGPUR

Principal
PRINCIPAL

Dharampeth M.P. Deo Memorial
Science College, Nagpur-440033



DHARAMPETH M. P. DEO MEMORIAL SCIENCE COLLEGE, NAGPUR
INTERNAL QUALITY ASSURANCE CELL (IQAC)
Activity Report (2022-23)

Date: 15/03/2023

Name of Organizing Department or Committee: Department of Physics in association with Statistics, Mathematics, Computer Science and Electronics.

Name of the activity: Study Tour to visit Fly Ash Bricks Factory, Chandpur and Ambagad Near Bhandara

Suggested CRITERION point if any: 5.3

Date of Activity: 12-03-2023

Place of Activity: Madni Bricks Company, Tumsar Road, Ambagad, Chandpur, Bhandara

Name of Guest Speaker/s or Judge/s or Chief Guest/s if any: Mr. Guddu Madankar and other workers

Title of the Activity: Study Tour to visit Fly Ash Bricks Factory, Chandpur and Ambagad Near Bhandara

Number of Participants: 36

Name of the Teacher In-charge / Convener: Lt. Dr. Prashant Ambekar

Names of other Committee Members / Staff: Ms. Ankita Wankhede

OUTCOME of the Activity with respect to mission vision of the institute and or academics:

The participants got a new insight in to the working of use of Fly Ash which is a biproduct of coal burning at the Thermal Power station. The mixture of Fly Ash with Sand and a little amount of Cement with water was mixed in proper ratio and after a homogeneous mixture having appropriate moisture it was transferred to the pressing machine via a conveyer belt. The bricks were immediately transferred and stacked on one layer over other. They are then dried naturally and cured further for its better strength.

The main advantage of the process is to provide a quality, environment friendly bricks in short time as compared with the clay bricks which has a very tedious process and harmful to the ecosystem. The students were also happy to see the 400 years old fort made by the Gond King, the Ambagarh and Chandpur lake and natural beauty which are nearby Tumsar, Bhandara

Activity with newspaper coverage if any: NA

Activity data save in PC of:

Lt. Dr. P. W. Ambekar

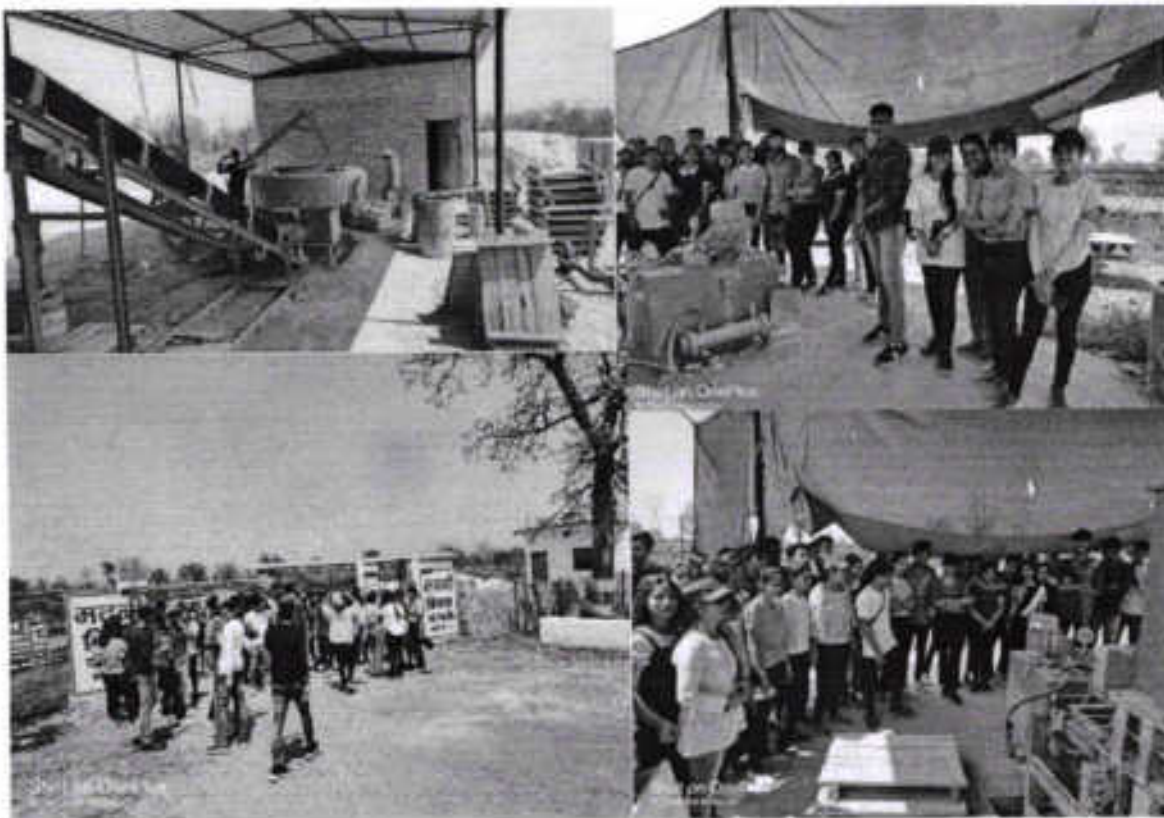

Consent Form Link:

[https://docs.google.com/spreadsheets/d/1Gd-](https://docs.google.com/spreadsheets/d/1Gd-1hws0yEKeHP79Vw154xciMk1G1iaiDH99s1payhc/edit?usp=sharing)

[1hws0yEKeHP79Vw154xciMk1G1iaiDH99s1payhc/edit?usp=sharing](https://docs.google.com/spreadsheets/d/1Gd-1hws0yEKeHP79Vw154xciMk1G1iaiDH99s1payhc/edit?usp=sharing)

Lt. Dr. Prashant Ambekar

Name & Signature of Teacher In-charge

Prof. Pitambar Humane

IQAC Coordinator

CO ORDINATOR

**INTERNAL QUALITY ASSURANCE CELL
DHARAMPETH, M. P. DEO MEMORIAL &
SCIENCE COLLEGE, NAGPUR**

Dr. Akhilesh Peshwe

Principal

**PRINCIPAL
Dharampeth M. P. Deo Memorial
Science College, Nagpur.**

Date: 08-03-2023

Nagpur

To,
The Principal,
Dharampeth M. P. Deo Memorial Science College, Nagpur

Subject: Request to Grant permission for a Study Tour and visit to Fly Ash Bricks Factory, Chandpur and Ambagad Dist. Bhandara
Reference: Your noting on student's application regarding study tour cum visit to a Fly ash brick factory, Chandpur and Ambagad near Bhandara.

Respected Sir,

The students of Department of Physics want to organize a study tour cum visit to the Fly Ash factory, Chandpur and Ambagad near Bhandara on 12-03-2023 (Sunday).

I therefore, request you to kindly grant us permission for the same. As per your remarks on the application stated above, the duly filled risk certificate from every student will be collected before the start of the tour.

Dr. Nitin Gaikwad (Maths) and Ms. Ankita Wankhede (Home Science) will be accompanying me on the visit. There will be no financial burden on the Department/ College. The entire cost of the visit including travel and food will be shared by the participants only.

As of now the 45 students have consented for the visit, however, if the number exceed an another vehicle may be booked.

Thanking you.

Lt. Dr. Ambekar

Pl ensure that booked vehicles

have insurance and trained drivers
are from registered tour
agency.

ST is also a good option
in cases like this



PRINCIPAL,
Dharampeth M. P. Deo Memorial
Science College, Nagpur.

Yours sincerely,

(Lt. Dr. P. W. Ambekar)
Head & Associate Professor
Department of Physics

Date: 08-03-2023

Nagpur

To,
The Principal,
Dharampeth M. P. Deo Memorial Science College, Nagpur

Subject: Request to Grant permission for a Study Tour and visit to Fly Ash Bricks Factory, Chandpur and Ambagad Dist. Bhandara
Reference: Your noting on student's application regarding study tour cum visit to a Fly ash brick factory, Chandpur and Ambagad near Bhandara.

Respected Sir,

The students of Department of Physics want to organize a study tour cum visit to the Fly Ash factory, Chandpur and Ambagad near Bhandara on 12-03-2023 (Sunday).

I therefore, request you to kindly grant us permission for the same. As per your remarks on the application stated above, the duly filled risk certificate from every student will be collected before the start of the tour.

Dr. Nitin Gaikwad (Maths) and Ms. Ankita Wankhede (Home Science) will be accompanying me on the visit. There will be no financial burden on the Department/ College. The entire cost of the visit including travel and food will be shared by the participants only.

As of now the 45 students have consented for the visit, however, if the number exceed an another vehicle may be booked.

Thanking you.

Yours sincerely,



(Lt. Dr. P. W. Ambekar)
Head & Associate Professor
Department of Physics





DHARAMPETH M. P. DEO MEMORIAL SCIENCE COLLEGE,
North Ambazari Road, Near Ambazari Lake, Nagpur-440033

DATA VALIDATION & VERIFICATION (DVV)

Name of the Programme : Study Tour and Visit to Fly Ash Bricks Factory, Chandpur and Ambagad Dist, Bhandara
Date of the Programme : 12-03-2023
Name of Chief Guest if any : NA
Name of Guest Speaker if any : Dr. Nitin Gaikwad, Ms. Ankita Wankhede & Lt. Dr. Prashant Ambekar as Organizers

Sr. No.	Name of the Participant	Mobile Number	E-mail Id	Signature
1)	Akash . Ashok . Sikdar	9175422051	sikdarakash015@gmail.com	Akash
2)	Kartik Adlakhia	8530597159	k.adlakhia@gmail.com	Kartik
3)	Prigyaneshu . B. Singh	7775800561	Singhprigyaneshu0784@gmail.com	Prigyaneshu
4)	Vishal Kumar Singh	9610187223	singhvrchat9602@gmail.com	Vishal
5)	Prachi, Manu Smare	9356969609	prachi2810@gmail.com	Prachi
6)	Diveya . Dhude	7030739921	diveyani dhude 2002@gmail.com	Diveya
7)	Sakshi . Banapathe	8317219372	sakshi2002bb@gmail.com	Sakshi
8)	Mitraj . Chauhan	9420626335	mitrajmitrajchauhan7102@gmail.com	Mitraj
9)	Pragya Jha	8665852975	pragyaj697@gmail.com	Pragya
10)	Akanksha yelure	8767935524	akankshayelure@gmail.com	Akanksha

Signature of:

Programme In-charge

CO-ORDINATOR
IQAC Coordinator
INTERNAL QUALITY ASSURANCE CELL
DHARAMPETH, M. P. DEO MEMORIAL &
SCIENCE COLLEGE, NAGPUR

Principal
PRINCIPAL
Dharampeth M. P. Deo Memorial
Science College, Nagpur.



DHARAMPETH M. P. DEO MEMORIAL SCIENCE COLLEGE,
North Ambazari Road, Near Ambazari Lake, Nagpur- 440033

DATA VALIDATION & VERIFICATION (DVV)

11	pallavi Bnagat	9022654940	pallavi2008@gmail.com	Bnagat	<i>[Signature]</i>
12	Chaitali bimbade	9859540899	Chaitali2006@gmail.com	Chaitali	<i>[Signature]</i>
13	Raksha dhote	7998511875	rakshadhote3@gmail.com	R. Dhote	<i>[Signature]</i>
14	prityanshi singh	7218259020	prityanshisingh1040@gmail.com	Singh	<i>[Signature]</i>
15	Anushka das	7058933157	ad04032001@gmail.com	Das	<i>[Signature]</i>
16	Ritu Chaudhary	8180962189	Ritulalitchaudhary@gmail.com	Chaudhary	<i>[Signature]</i>
17	Pratiksha chandhori	7507317689	pratikshachandhori@gmail.com	Pratiksha	<i>[Signature]</i>
18	shubhangi R. Nishad	8975244942	shubhishad2510@gmail.com	Nishad	<i>[Signature]</i>
19	sovi Rai	9855989509	sovisonmail7@gmail.com	Rai	<i>[Signature]</i>
20	SAKSHI R. CHAKUNDE	7843018801	saksichakunde@gmail.com	Chakunde	<i>[Signature]</i>
21	Anshikha U. Jarwankar	9021891207	anshikhajarwankar@gmail.com	Anshikha	<i>[Signature]</i>
22	Aditi R. Vaidya	9075714591	aditivaidya619@gmail.com	Vaidya	<i>[Signature]</i>
23	Hemlata D. verma	7514058379	vermahemlata987@gmail.com	Verma	<i>[Signature]</i>
24	Nilrita G. Ekre	7972190515	ekrenilrita944@gmail.com	Ekre	<i>[Signature]</i>
25	Damini M. Bhandbuche	8275105785	bhandbuchedamini@gmail.com	D. Bhandbuche	<i>[Signature]</i>
26	Supriya Patte	7757871925	PatteSupriya@gmail.com	Patte	<i>[Signature]</i>

Signature of:

[Signature]

Programme In-charge

[Signature]
CO ORDINATOR

INTERNAL QUALITY ASSURANCE CELL
DHARAMPETH, M. P. DEO MEMORIAL &
SCIENCE COLLEGE, NAGPUR

[Signature]
PRINCIPAL

Dharampeth M. P. Deo Memorial
Science College, Nagpur.



DHARAMPETH M. P. DEO MEMORIAL SCIENCE COLLEGE,
North Ambazari Road, Near Ambazari Lake, Nagpur- 440033

DATA VALIDATION & VERIFICATION (DVV)

27	Shivani Bhute	9302900209	bhuteshivani895@gmail.com	Shivani	Shivani
28	Suraj Shende	9856666487	surajshende123@gmail.com	Suraj	Suraj
29	Shivam Mawra	9607873702	shivamawra@gmail.com	Shivam	Shivam
30	Chetan Kavathe	9637271601	chetankavathe@gmail.com	Chetan	Chetan
31	Pignesh . G. Kapse	9973569027	Kapsepignesh03@gmail.com	Pignesh	Pignesh
32	Sumit . Bhalikar	9021627757	sumitbhalikar200@gmail.com	Sumit	Sumit
33	Tushar . S. Wadhwa	7038980231	aryaliwadhwa@gmail.com	Tushar	Tushar
34	Himanshu Lakhe	7448252469	himanshu211200@gmail.com	Himanshu	Himanshu
35	Tanmay Bhat	7697250831	tanmaybhat900@gmail.com	Tanmay	Tanmay
36	Ishwan Suryawanshi	8087317237	suryawanshi@gmail.com	Ishwan	Ishwan
37	Vaishnavi K. Pradhan	9763169560	madhavyaishnavi155@gmail.com	Vaishnavi	Vaishnavi
38	Shreeshi Patekar	7387067403	shreeshipatekar@gmail.com	Shreeshi	Shreeshi
39	Shalu Pandhi	8329115380	shalupandhi2@gmail.com	Shalu	Shalu
40	Uday Kondarkar	9545897196	udaykondarkar20@gmail.com	Uday	Uday
41	Adesh Hatwar	7817481162	aaadeshhatwar2002@gmail.com	Adesh	Adesh
42	Dolly Gubhane	9284269236	dollygubhane7@gmail.com	Dolly	Dolly

Signature of:

Programme In-charge

IQA COORDINATOR

INTERNAL QUALITY ASSURANCE CELL
DHARAMPETH, M. P. DEO MEMORIAL &
SCIENCE COLLEGE, NAGPUR

PRINCIPAL

Dharampeth M. P. Deo Memorial
Science College, Nagpur



DHARAMPETH M. P. DEO MEMORIAL SCIENCE COLLEGE,
North Ambazari Road, Near Ambazari Lake, Nagpur- 440033

DATA VALIDATION & VERIFICATION (DVV)

43	Prachi Varabhe	9825335932		P. Varabhe
44	Sakshi Gizi	9529660277	sakshigizi204@gmail.com	<u>Sakshi</u>
45	Seema Lakda	7058728070	seemalakda073@gmail.com	<u>Seema</u>
46	Sujata. Dhauraj. Sonwane	9021135140	sujatasonwane2001@gmail.com	<u>Sujata</u>
47	Aditi -K. Dhokte	8847709571	aditidhokte4@gmail.com	<u>Aditi</u>
48	Bhagyawathi R. Pandey	9175302601	pandeybhagyawathi@gmail.com	<u>Bhagyawathi</u>
49	Kajal .T. Prasad	7410763138	prasad.kajal2004@gmail.com	<u>Kajal</u>
50	Tanushree R. Dal	9766927406	tanushreedal@gmail.com	<u>Tanushree</u>
51	Anjali N. Charde	9261964188	anjalicarde20@gmail.com	<u>Anjali</u>
52	Vaibhav S. Rane	7744951383	Vaibhavrane2007@gmail.com	<u>Vaibhav</u>

P. Varabhe
Sakshi
Seema
Sujata
Aditi
Bhagyawathi
Kajal
Tanushree
Anjali
Vaibhav

Signature of:

Programme In-charge

CO ORDINATOR
INTERNAL QUALITY ASSURANCE CELL
DHARAMPETH, M. P. DEO MEMORIAL &
SCIENCE COLLEGE, NAGPUR

PRINCIPAL
Dharampeth M. P. Deo Memorial
Science College, Nagpur.

To,
The Principal,
Dharampeth Science College,
Nagpur.

Date:- 4th March 2023

Subject:- Permission for Physics Dept. tour
(IIIrd Year).

Respected Sir,

Our Physics Department wants to organise a study tour on 12th Feb March 2023 at following places:-
Rice Mill, Fly Ash Bricks factory & Chandpur [near Tumsar].

We request you to grant permission for the same.

Thanking You.

Yours faithfully,
Final Year
Students. (Physics
Dept)

- To
Dr. Lt. Ambekar
- Pl.
1. unadvised
Risk Intification
 2. Int. note IAC.

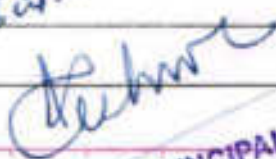

Shrikrupa PRINCIPAL
Dharampeth M. P. Deo Memorial
Science College, Nagpur.

Physics
Name

	Name	Batch	Sign
1]	Vaibhav Rane	T-1	<u>Rane</u>
2]	Mitraj Chavhan	T-1	<u>Chavhan</u>
3]	Kartik Adlakhia	T-7	<u>Adlakhia</u>
4]	Uday Kandankar	T-1	<u>Kandankar</u>
5]	Sakshi Barapatre	T-1	<u>Barapatre</u>
6]	Himanshu Lakhe	T-1	<u>Lakhe</u>
7]	Prachi Manuomare	T-1	<u>Manuomare</u>
8]	Divyani Dhule	T-1	<u>Dhule</u>
9]	Prachi Varabhe	T-7	<u>Varabhe</u>
10]	Dolly Grabhne	T-7	<u>Grabhne</u>
11]	Sulphuya Patle	T-7	<u>Patle</u>
(CR) 12]	Tanmay Patle Bhute	T-10	<u>Tanmay</u>
13]	Adesh V. Halwar	T-8	<u>Halwar</u>
14]	Akash A. Sikdar	T-10	<u>Akash</u>
15]	Piyush G. Kapse	T-1	<u>Kapse</u>
16]	Shivam S. Mewary	T-8	<u>Shivam</u>
17]	Tishwar Suryawanshi	T-9	<u>Suryawanshi</u>
18]	Saurabh Sharma	T-3	<u>Sharma</u>
19]	Rajal Gaikwad	T-1	<u>Gaikwad</u>
20]	Pratigya Jha	T-8	<u>Jha</u>
21]	Raksha dhote	T-8	<u>Dhote</u>
22]	Chaitali Bursade	T-8	<u>Bursade</u>
23]	Akanksha yelure	T-8	<u>Yelure</u>
24]	priyanshi Singh	T-8	<u>Singh</u>
25]	Anushka das	T-8	<u>Das</u>
26]	pallavi Bhogat	T-10	<u>Bhogat</u>
27]	Tanmay Bhute	T-10	<u>Bhute</u>
28]	Shivam manyu	T-8	<u>Shivam</u>
29]	Prityanshu Singh	T-9	<u>Singh</u>



DHARAMPETH M. P. DEO MEMORIAL SCIENCE COLLEGE, NAGPUR
INTERNAL QUALITY ASSURANCE CELL (IQAC)

Activity Report

Date: 31/03/2023

Name of Organizing Department or Committee: Computer Science

Name of the activity: Poster Making

Suggested CRITERION point if any: V

Date of Activity: 12/03/2023 (Submission Date: 15/03/2023)

Place of Activity: Online

Name of Guest Speaker/s or Judge/s or Chief Guest/s if any: NA

Title of the Activity: Digital Poster Making on topics Internet Security, Internet Uses and Internet Jargon

Number of Participants: 35

Name of the Teacher In-charge / Convener: Mrs. Ruma Kapre

OUTCOME of the Activity with respect to mission vision of the institute and or academics:

For making digital poster students uses many online software available for making poster. Through this activity student learned how to use online software and also presents their ideas and thoughts on the current topic given for Poster Making.

Activity with newspaper coverage if any: NA

Activity data save in PC of: Mrs. Ruma Kapre



Prof. Pitambar Humane

IQAC Coordinator

CO ORDINATOR

INTERNAL QUALITY ASSURANCE CELL
DHARAMPETH, M. P. DEO MEMORIAL &
SCIENCE COLLEGE, NAGPUR

Dr. Anillesh Peshwe

Principal

PRINCIPAL
DHARAMPETH M.P. DEO
MEMORIAL SCIENCE COLLEGE
NAGPUR



DHARAMPETH M. P. DEO MEMORIAL SCIENCE COLLEGE, NAGPUR
INTERNAL QUALITY ASSURANCE CELL (IQAC)

Activity Report

Date: 31/03/2023

Name of Department: Computer Science

Name of Activity: Digital Poster Making on “Internet Security, Internet Uses and Internet Jargon”

Date of Activity: 12/03/2023 Submission Date 15/03/2023

Number of Students Participated: 35

Responses Link:

<https://docs.google.com/spreadsheets/d/1AsG9HHhEv7Ps3VvKLRkSCmfNDh8Egk-A90EKSstGA/edit?usp=sharing>



Prof. Pitambar Humane
IQAC Coordinator

CO ORDINATOR
INTERNAL QUALITY ASSURANCE CELL
DHARAMPETH, M. P. DEO MEMORIAL &
SCIENCE COLLEGE, NAGPUR

Dr. Achyut Peshwe
Principal

PRINCIPAL
DHARAMPETH M.P. DEO
MEMORIAL SCIENCE COLLEGE
NAGPUR



DHARAMPETH M. P. DEO MEMORIAL SCIENCE COLLEGE, NAGPUR

INTERNAL QUALITY ASSURANCE CELL (IQAC)

Activity Report

Date: 13th March 2023

Name of Organizing Department or Committee : Electronics Department

Name of the Activity : Study of IC 565 using datasheet

Suggested CRITERION point if any : Suggested criteria II

Date of Activity : 13th March 2023

Place of Activity : Electronics Lab

Name of Guest Speaker/s or Judge/s or Chief Guest/s if any : Not applicable

Title of the Activity: Study of IC 565 using datasheet

Based on Unit : 3(Paper II)

Class : Semester IV

Number of Participants : 18

Name of the Teacher In-charge / Convener: Mrs. Leena P. Thakare

OUTCOME of the Activity with respect to mission vision of the institute and or academics:

Students studied pin diagram and pin functions of IC 565. They also studied different applications of IC 565 using datasheet.

Prof. P. S. Humane
CO ORDINATOR
INTERNAL QUALITY ASSURANCE CELL
IQAC Coordinator
DHARAMPETH, M. P. DEO MEMORIAL &
SCIENCE COLLEGE, NAGPUR

Dr. V. Rangari
Prof. V. Rangari
Professor & Head
Head of the Department
Department of Electronics
Dharampeth M.P. Deo Memorial
Science College, Nagpur

Dr. Akhilesh Peshwe
Principal
Principal
Dharampeth M.P. Deo Memorial
Science College, Nagpur.



DHARAMPETH M. P. DEO MEMORIAL SCIENCE COLLEGE, NAGPUR

Department of Electronics

Semester IV- (2022-23)

Activity (Paper II- Unit- 3)

Sr. No.	FullName	Student Mobile No	StudentEmailId
1	Sakshi Vinod Kanade	8806934839	Sakshikanade326@gmail.com
2	Urvashi Sunilrao Umathe	9527708361	pragatichaure01@gmail.com
3	Bhagyarathi Ramvinay Pandey	9175302601	pandeybhagyarathi@gmail.com
4	Janvi Ashok Kosarkar	8975756916	Janvikosarkar@gmail.com
5	Pratham Ankush Sitkare	9022553288	prathamsitkare@gmail.com
6	Jay Anilbhai Patil	7385436956	jay.patil0326@gmail.com
7	Renuka Vishal Lande	7719951401	renukalande220@gmail.com
8	Rahul Ramesh Kawade	9359525716	kawaderahul042@gmail.com
9	Ankush Samma Gawade	7588194156	agawde5603@gmail.com
10	Yash Ravindra Khedekar	7020829422	yashkhedekar5@gmail.com
11	Prakhar Rajesh Buradkar	8329760853	prakhar.buradkar560@gmail.com
12	Unnatitai Chatrapal Chopde	9022627617	unnatichopde2002@gmail.com
13	Mansi Dilip Nandanwar	7709322027	mansinandanwar19@gmail.com
14	Aasmin Abdulkhalik Sheikh	8788490684	abdulkhalik563698@gmail.com
15	Tushar Wadhve		
16	Prajwai Mulchand Bhade	9834016826	matesamu17@gmail.com
17	Chetan Umashankar Bopche	9172484628	chetanbopche27@gmail.com
18	Durgesh Krishna Singh	7385310432	ds608531@gmail.com

Name & Signature of Teacher In-Charge

Prof. Pitambar Humane
IQAC Coordinator

CO ORDINATOR

INTERNAL QUALITY ASSURANCE CELL
DHARAMPETH, M. P. DEO MEMORIAL &
SCIENCE COLLEGE, NAGPUR

Name & Signature of Head of the Department

Dr. Varsha V. Rangari
Professor & Head
Department of Electronics
Dharampeth M.P. Deo Memorial
Science College, Nagpur

Dr. Ajhilesh Peshwe
Principal

Principal
Dharampeth M.P. Deo Memorial
Science College, Nagpur.



**DHARAMPETH M. P. DEO MEMORIAL SCIENCE COLLEGE, NAGPUR
INTERNAL QUALITY ASSURANCE CELL (IQAC)**

Date: 14/03/2023

Name of Organizing Department/ Committee: Home Science Department

Name of the activity: Demonstration on Artificial Flower making & Arrangement

Suggested CRITERION point if any: Criterion II

Date of Activity: 14/03/2023

Place of Activity: Home Science Department

Name of Guest Speaker/s or Judge/s or Chief Guest/s if any: Meenalshi Khargar

Title of the Activity: Artificial Flower making & Arrangement

Number of Participants: 10

Name of the Teacher In-charge/Convener: Ms. Ankita Wankhede,

Names of other Committee Members/Staff: Mrs. Manju Deshpande

OUTCOME of the Activity with respect to mission vision of the institute and or academics:

1. Artificial flower making is a form of art and craft, allowing students to explore their creativity and express themselves through hands-on activities.
2. Learning how to make artificial flower can open up entrepreneurial possibilities for college students. They can use their skills to create and sell handmade artificial flower arrangement, bouquets, or decorations. This can be a source of income or a potential business venture in the future.

Activity with newspaper coverage if any:

Activity data save in PC of:

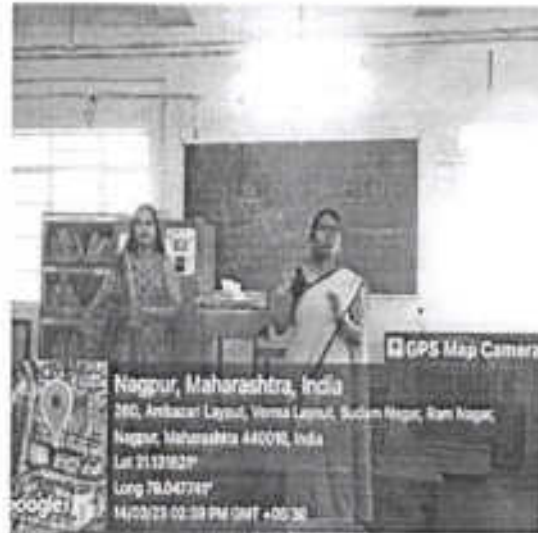
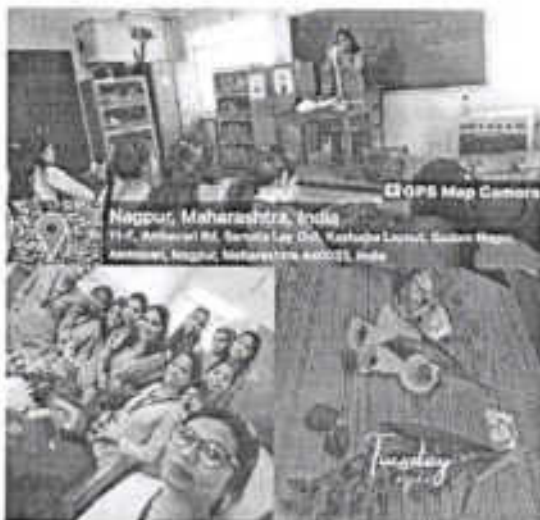

Prof. Pitambar Humane
CO-ORDINATOR
INTERNAL QUALITY ASSURANCE CELL
DHARAMPETH, M. P. DEO MEMORIAL &
SCIENCE COLLEGE, NAGPUR

uphite

Name & Signature of Teacher In-charge

Dr. Akhilesh Peshwe
PRINCIPAL
Dharampeth M. P. Deo Memorial
Science College, Nagpur.



DHARAMPETH M. P. DEO MEMORIAL SCIENCE COLLEGE,
North Ambazari Road, Near Ambazari Lake, Nagpur- 440033

DATA VALIDATION & VERIFICATION (DVV)

Name of the Programme : Artificial Flower Making & Arrangement
Date of the Programme : 14/08/23
Name of Chief Guest if any : Meenakshi Khargur
Name of Guest Speaker if any : _____

Sr. No.	Name of the Participant	Mobile Number	E-mail Id	Signature
1.	Anchal D. Kakande	9309560449	anchalkakande28@gmail.com	<u>Anchal</u>
2.	Aditi R. Vaidya	9075714591	aditivaidya619@gmail.com	<u>Aditi</u>
3.	Prerna J. Chaudhari	7620384149	chaudhariprerna2946@gmail.com	<u>Prerna</u>
4.	SAKSHI R. CHAKUNDE	7843018801	sakshichakunde@gmail.com	<u>Sakshi</u>
5.	Anshikha U. Jaiswal/teer	9021391207	anshikhajaiswalteer@gmail.com	<u>Anshikha</u>
6.	Bhavana Gurudasani	8888437303	bhavanagurudasani@gmail.com	<u>Bhavana</u>
7.	Shalu Paudhi	8329115380	shalupaudhi@gmail.com	<u>Shalu</u>
8.	Ninal patte	9158070732	patteminail@gmail.com	<u>Ninal</u>
9.	Hemlata P. Verma	7517028379	hemlata957@gmail.com	<u>Hemlata</u>
10.	Neha R. Vishwakarma	9975846776	nehavishwakar@gmail.com	<u>Neha</u>

Signature of:

Programme In-charge

Ankita Wankhede

IQAC COORDINATOR
INTERNAL QUALITY ASSURANCE CELL
DHARAMPETH, M. P. DEO MEMORIAL &
SCIENCE COLLEGE, NAGPUR

PRINCIPAL
Dharampeth M. P. Deo Memorial
Science College, Nagpur



DHARAMPETH M. P. DEO MEMORIAL SCIENCE COLLEGE, NAGPUR

INTERNAL QUALITY ASSURANCE CELL (IQAC)

Activity Report

Date: 14-03-2023

Name of Organizing Department or Committee: Department of Statistics.

Name of the activity: Construction of box plot and q-q plot and their use in describing data

Suggested CRITERION point if any:

Date of Activity: 14 March 2023

Place of Activity: Statistics lab

Name of Guest Speaker/s or Judge/s or Chief Guest/s if any:

Title of the Activity: Construction of box plot and q-q plot and their use in describing data

Number of Participants: 22

Name of the Teacher: Durga hingwe

Names of other Committee Members / Staff: N.A.

OUTCOME of the Activity with respect to mission vision of the institute and or academics:

Using box plots we can better understand our data by understanding its distribution, outliers, mean, median, and variance. Box plot packs all of this information about our data in a single concise diagram.

Activity with newspaper coverage if any: No

Activity data save in PC of: Department of Statistics.

Prof. Pitambar Humane
IQAC Coordinator

COORDINATOR
INTERNAL QUALITY ASSURANCE CELL
DHARAMPETH, M. P. DEO MEMORIAL &
SCIENCE COLLEGE, NAGPUR

Name & Signature of Teacher In-charge

Dr. Akhilesh Peshwe
Principal
Dharampeth M.P. Deo Memorial
Science College, Nagpur.



DHARAMPETH M. P. DEO MEMORIAL SCIENCE COLLEGE NAGPUR

Department of Statistics

Class: B.Sc. Sem. - II

NEP ACTIVITY

Paper: II

Unit: III

Name of the Teacher: Durga C. HingweDate: 14-03-23Title of Activity: construction of box plot and q-q plot and their use in describing data.

Sr. No.	Name of Student	Batch	Mobile No.	Email ID	Signature
1.	Dhruvani V. Zagade	S.COM	9022866318	dhruvani.zagade@gmail.com	<u>D Zagade</u>
2.	Janvi Khode	S.COM	7385066634	Janvi.khode892@gmail.com	<u>J Khode</u>
3.	Branali V. Gupta	SCOM	7020069377	kg991539@gmail.com	<u>B Gupta</u>
4.	Megha S. Ballav	PSM	9421728800	meghaballav@gmail.com	<u>M Ballav</u>
5.	Veena Borikar	SCOM	9322016921	veenaborikar14@gmail.com	<u>V Borikar</u>
6.	Varsha Tukkar	F2	8373650950	varshatukkar45@gmail.com	<u>V Tukkar</u>
7.	Mohit Khurdkar	SCOM	8055329357	mohitkhurdkar@gmail.com	<u>M Khurdkar</u>
8.	Pradnya Tapude	SCOM	8010362232	pradnyatapudegust@gmail.com	<u>P Tapude</u>
9.	Janvi Kinnapure	SCOM	7058235243	janvikinnapure@gmail.com	<u>J Kinnapure</u>
10.	Mohit Khurdkar	SCOM	8055329357	Mohit	<u>M Khurdkar</u>
11.	Janvi Khode	S.COM	7385066634	Janvi.khode892@gmail.com	<u>J Khode</u>
12.	Ishita Deshpande	SCOM	9130091540	ishitadeshpande21@gmail.com	<u>I Deshpande</u>
13.	Jagruati Fulkawar	SCOM	8767911307	jagruatifulkawar@gmail.com	<u>J Jagruati</u>
14.	Utkarsha Ingale	SCOM	7499159178	utkarshaingale9@gmail.com	<u>U Ingale</u>
15.	Devashi Karkade	SCOM	9021344265	karkadedevashi@gmail.com	<u>D Karkade</u>
16.	Sonia Niwal	SCOM	7058425024	soniანიwal@gmail.com	<u>S Niwal</u>
17.	Nisha Kosarkar	SCOM	9890996645	nishakosarkar333@gmail.com	<u>N Nisha</u>
18.	Sakshi Mishra	SCOM	9529889315	sinishra039683@gmail.com	<u>S Mishra</u>
19.	Janvi Laibheri	SCOM	8446510539	janvilalibheri@gmail.com	<u>J Laibheri</u>
20.	Janhui Joge	F2	7305060871	janhujoge08@gmail.com	<u>J Joge</u>
21.	Pranali Dahanekar	F2	8767581278	pdahna@gmail.com	<u>P Dahanekar</u>
22.	Nayana N. Walthare	F1	7841870747	snayanawalthare@gmail.com	<u>N Walthare</u>
23.	Vidya Lohi	F2	7020903219	vidyalohi8@gmail.com	<u>V Lohi</u>

D Hingwe
Signature of Teacher

D Hingwe
Teacher in Charge



DHARAMPETH M. P. DEO MEMORIAL SCIENCE COLLEGE, NAGPUR

INTERNAL QUALITY ASSURANCE CELL (IQAC)

Activity Report

Date: 15th March 2023

Name of Organizing Department or Committee : Electronics Department

Name of the Activity : Identification and study of transmission lines.

Suggested CRITERION point if any : Suggested criteria II

Date of Activity : 15th March 2023

Place of Activity : Electronics Lab

Name of Guest Speaker/s or Judge/s or Chief Guest/s if any : Not applicable

Title of the Activity: Identification and study of transmission lines.

Based on Unit : 4(Paper I)

Class : Semester IV

Number of Participants : 16

Name of the Teacher In-charge / Convener: Prof. V. V. Rangari

OUTCOME of the Activity with respect to mission vision of the institute and or academics:

Students studied different types of cables and their use in transmission lines.

Prof. Pitambar Humane

CO ORDINATOR

INTERNAL QUALITY ASSURANCE CELL
DHARAMPETH M. P. DEO MEMORIAL SCIENCE COLLEGE, NAGPUR

Dr. Varsha V. Rangari
Professor & Head
Head of the Department
Department of Electronics
Dharampeth M.P. Deo Memorial
Science College, Nagpur

Dr. Akhilesh Peshwe

Principal

Dharampeth M.P. Deo Memorial
Science College, Nagpur.



DHARAMPETH M. P. DEO MEMORIAL SCIENCE COLLEGE, NAGPUR

Department of Electronics

Semester IV- (2022-23)

Activity (Paper I- Unit- 4)

Sr. No.	Full Name	Student Mobile No	Student Email Id
1	Janvi Ashok Kosarkar	8975756916	Janvikosarkar@gmail.com
2	Pratham Ankush Sitkare	9022553288	prathamsitkare@gmail.com
3	Jay Anilbhai Patil	7385436956	jay.patil0326@gmail.com
4	Urvashi Sunilrao Umathe	9527708361	pragatichaure01@gmail.com
5	Renuka Vishal Lande	7719951401	renukalande220@gmail.com
6	Rahul Ramesh Kawade	9359525716	kawaderahul042@gmail.com
7	Ankush Samma Gawade	7588194156	agawde5603@gmail.com
8	Yash Ravindra Khedekar	7020829422	yashkhedekar5@gmail.com
9	Prakhar Rajesh Buradkar	8329760853	prakhar.buradkar560@gmail.com
10	Bhagyarathi Ramvinay Pandey	9175302601	pandeybhagyarathi@gmail.com
11	Unnatitai Chatrapal Chopde	9022627617	unnatichopde2002@gmail.com
12	Mansi Dilip Nandanwar	7709322027	mansinandanwar19@gmail.com
13	Aasmin Abdulkhalik Sheikh	8788490684	abdulkhalik563698@gmail.com
14	Tushar Wadhve		
15	Prajwal Mulchand Bhade	9834016826	matesamu17@gmail.com
16	Chetan Umashankar Bopche	9172484628	chetanbopche27@gmail.com

Name & Signature of Teacher In-Charge

Prof. Pitambar Humane
IQAC Coordinator

CO ORDINATOR
INTERNAL QUALITY ASSURANCE CELL
DHARAMPETH, M. P. DEO MEMORIAL &
SCIENCE COLLEGE, NAGPUR

Name & Signature of Head of the Department

Dr. Varsha V. Rangari
Professor & Head
Department of Electronics
Dharampeth M.P. Deo Memorial
Science College, Nagpur

Dr. Akhilesh Peshwe

Principal

Principal
Dharampeth M.P. Deo Memorial
Science College, Nagpur.



DHARAMPETH M. P. DEO MEMORIAL SCIENCE COLLEGE, NAGPUR
INTERNAL QUALITY ASSURANCE CELL (IQAC)

NEP Activity Report

Date: 15/03/2023

Name of Organizing Department or Committee: Chemistry Department

Name of the activity: NEP Activity Report (Sem- II, Unit-III)

Suggested CRITERION point if any: Criteria II

Date of Activity: 15/03/2023

Place of Activity: Corridor of Chemistry Department

Name of Guest Speaker/s or Judge/s or Chief Guest/s if any: Nil

Title of the Activity: Data and Composition L.P. G.

Number of Participants: 46

Name of the Teacher In-charge / Convener: Dr. Pranita Gawande

Names of other Committee Members / Staff: Dr. Vaishali Meshram

OUTCOME of the Activity with respect to mission vision of the institute and or academics:

Liquefied petroleum gas called as LPG is important constituent of every house. It is related to our day to day life. So students should be aware about the chemistry of LPG. This activity gives students the insight about the LPG.

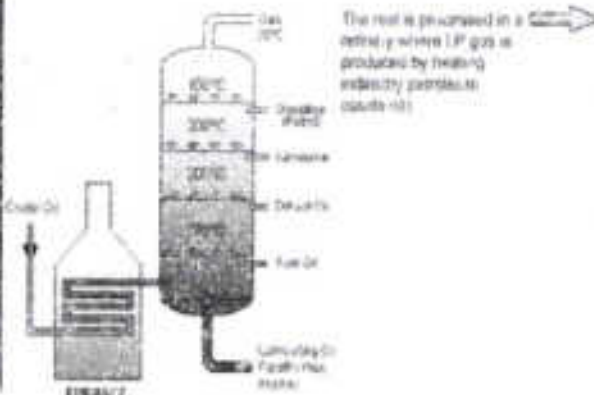

Activity with newspaper coverage if any: Nil

Activity data save in PC of: Chemistry Department

Note: Kindly share geotag photographs separately along with report on iqacdscc2022@gmail.com

Prof. Pitambar Humane
IQAC Coordinator

CO ORDINATOR
INTERNAL QUALITY ASSURANCE CELL
DHARAMPETH, M. P. DEO MEMORIAL &
SCIENCE COLLEGE, NAGPUR

Name & Signature of Teacher In-charge

Dr. Akhilesh Peshwe
Principal

PRINCIPAL
Dharampeth M.P. Deo Memorial
Science College, Nagpur-440037



DHARAMPETH M. P. DEO MEMORIAL SCIENCE COLLEGE,
North Ambazari Road, Near Ambazari Lake, Nagpur- 440033

DATA VALIDATION & VERIFICATION (DVV)

Name of the Programme : NEP Activity - Data and composition L.P.G. (Sem II, Paper I, unit III)
Date of the Programme : 15-03-23
Name of Chief Guest if any : _____
Name of Guest Speaker if any : _____

Sr. No.	Name of the Participant	Mobile Number	E-mail Id	Signature
1-	Ritika R. Bhojar	9834581087	ritikabhojar28@gmail.com	
2-	Durgesh K. Ghodmare	9075318618	durgeshghodmare001@gmail.com	
3-	Ruchi P. Rivedi	8080776893	Ruchiwivedivel23@gmail.com	
4-	Shivam U. Patel	7088889083	sp040263@gmail.com	
5-	Pratibha B. Bhusari	7821048413	pbhusari718@gmail.com	
6-	Ankit R. Patel	9970905638	ankitpatel79275@gmail.com	
7-	Saurabh S. Chaudhary	9359883501	schaudhary559@gmail.com	
8-	Shrutika G. Pise	9322316336	shrutikapise67@gmail.com	
9-	Vaishali M. Sahare	9972925403	Vaishalisahare251@gmail.com	
10-	Ashwini R. Chaudhary	9699702732	chaudharyashwini28@gmail.com	

Signature of:

Programme In-charge

IQAC Coordinator

CO ORDINATOR
INTERNAL QUALITY ASSURANCE CELL
DHARAMPETH, M. P. DEO MEMORIAL &
SCIENCE COLLEGE, NAGPUR

Principal

PRINCIPAL
Dharampeth M.P. Deo Memorial
Science College, Nagpur-440033



DHARAMPETH M. P. DEO MEMORIAL SCIENCE COLLEGE,
North Ambazari Road, Near Ambazari Lake, Nagpur- 440033

DATA VALIDATION & VERIFICATION (DVV)

11.	Khineshwari R. Pushptode	8624976072	khineshwaripushptode@gmail.com	Rh
12.	Sonal G. Chaudhari	8856055003	sonalichaudhari19@gmail.com	Dee
13.	Vaidehi P. Thote	7558499191	vaidehitote27@gmail.com	Patela
14.	Uman G. Wasathi	9322428500	umangwasathi@gmail.com	Wasathi
15.	Kartika M. Deshmukh	9699720960	KartikaDeshmukh@gmail.com	Kartika
16.	Ritika P. Sandwija	912558155	ritikasandwija@gmail.com	Ritika
17.	Shital O. Patte	9764596337	SP123@gmail.com	Patte
18.	Monika I. Patel	9499225468	monikaipatel7032@gmail.com	mpatel
19.	Yogita K. Thakre	784102443	yogitathakre2684@gmail.com	Ythakre
20.	Shreya G. Bhimte	9637762811	Shreyabhimte21@gmail.com	Shreya
21.	Karishma N. Prasad	9309318667	narendraprasad72@gmail.com	Karishma
22.	Komalika S. Chaudhari	9322033866	KomalikaChaudhari073@gmail.com	GC
23.	Apeksha Kotangale	7559455794	Apekshakotangale26@gmail.com	Kotangale
24.	Neha Wanjari	9373832266	Nehawanjari733@gmail.com	Neha
25.	Aparna Mahare	7020649887	oparnamahare23@gmail.com	Aparna
26.	Priyanshu Raut	9322725233	priyanshuraute56@gmail.com	Priyanshu
27.	Vaishnavi Tonge	8421657143	Vaishnavitonge2001@gmail.com	Vaishnavi
28.	Anjali Thakre	7066552831	thakreanjali931@gmail.com	Anjali
29.	Yogita Denge	7068437100	yogitadenge@gmail.com	YDenge

Signature of:

Programme In-charge

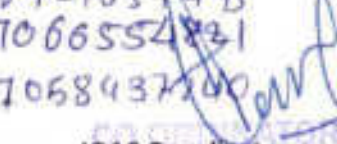
IQAC Coordinator
INTERNAL QUALITY ASSURANCE CELL
DHARAMPETH, M. P. DEO MEMORIAL &
SCIENCE COLLEGE, NAGPUR

Principal
PRINCIPAL
Dharampeth M.P. Deo Memorial
Science College, Nagpur-440033



DHARAMPETH M. P. DEO MEMORIAL SCIENCE COLLEGE,
North Ambazari Road, Near Ambazari Lake, Nagpur- 440033

DATA VALIDATION & VERIFICATION (DVV)

30)	Abhay P. Tembhore	8975363145	abhay230102@gmail.com	Abhy
31)	Chanchal K. Waghware	7796016894	waghwaremitara@gmail.com	chanchal
32)	Bhanashree U. Dhokane	9774900320	bhanashreeu@gmail.com	Bhanashree
33)	Priya Sharma	8010764549	priya12012009sharma@gmail.com	Priya
34)	Atkansha Maisral	5010923662	atkanshamaisral@gmail.com	Atkansha
35)	Sunaina Chichonde	8530970132	sunainaichichonde@gmail.com	Sunaina
36)	Dhanashree Neware	9359909913	dhanashreeneware78@gmail.com	Dhanashree
37)	Ashlesha Kholgi	7820929579	ashleshakholgi@gmail.com	Ashlesha
38)	Nisha Purdey	8605231390	nishap8023139@gmail.com	Nisha
39)	Krutika S. Pokale	9021533341	pokalekrutika6@gmail.com	Krutika
40)	Vaishnavi Tonge	8421657943	Vaishnavitonge2004@gmail.com	Vaishnavi
41)	Komalika Chaudhari	9322033866	komalikachaudhari079@gmail.com	Komalika
42)	Yashvini Pawdey	9156035297	pawdeykn54@gmail.com	Yashvini
43)	Tanya Phulewale	8454543857	tanyaphulewale7@gmail.com	Tanya
44)	Apiksha D. Ketangale	7559455794	apikshaketangale26@gmail.com	Apiksha
45)	Anjali R. Thakur	7066554822	anjalthakur@gmail.com	Anjali
46)	Lucky A Vishwakarma	957960186	lvishwakarma24@gmail.com	Lucky

Signature of:

P. M. J.
Programme In-charge

IQAC Coordinator
CO ORDINATOR
INTERNAL QUALITY ASSURANCE CELL
DHARAMPETH M. P. DEO MEMORIAL &
SCIENCE COLLEGE, NAGPUR

Dr. N. S. Patil
Principal
PRINCIPAL
Dharampeth M. P. Deo Memorial
College, Nagpur - 440033



DHARAMPETH M. P. DEO MEMORIAL SCIENCE COLLEGE, NAGPUR
INTERNAL QUALITY ASSURANCE CELL (IQAC)

Activity Report

Date: 16.03.2023

Name of Organizing Department or Committee: Dept. of Home Science

Name of the activity: Demonstration of the rainbow diet (NEP 2022 Activity)

Suggested CRITERION point if any:

Date of Activity: 16.03.2023

Place of Activity: Classroom, Dept. of Home Science

Name of Guest Speaker/s or Judge/s or Chief Guest/s if any:

Title of the Activity: Demonstration of the rainbow diet

Number of Participants: 10

Name of the Teacher In-charge / Convener: Mrs. Meghna Pandit

Names of other Committee Members / Staff:

OUTCOME of the Activity with respect to mission vision of the institute and or academics:

To develop understanding about the nutritional benefits of intake of different coloured fruits and vegetables.

Activity with newspaper coverage if any:

Activity data save in PC of: _____

Note: Kindly share geotag photographs separately along with report on iqacdsc2022@gmail.com

Prof. Pitambar Humane

IQAC Coordinator

COORDINATOR
INTERNAL QUALITY ASSURANCE CELL
DHARAMPETH M. P. DEO MEMORIAL &
SCIENCE COLLEGE, NAGPUR

Name & Signature of Teacher In-charge

Dr. Akhilesh Peshwe

Principal

PRINCIPAL

Dharampeth M.P. Deo Memorial
Science College, Nagpur-440033





DHARAMPETH M. P. DEO MEMORIAL SCIENCE COLLEGE,
North Ambazari Road, Near Ambazari Lake, Nagpur- 440033

DATA VALIDATION & VERIFICATION (DVV)

Name of the Programme : Demonstration of Rainbow diet
Date of the Programme : 16/03/2023
Name of Chief Guest if any : _____
Name of Guest Speaker if any : _____

Sr. No.	Name of the Participant	Mobile Number	E-mail Id	Signature
1	Anshikha U. Jaiswarakar	9021391207	anshikhajaiswarakar@gmail.com	Anshikha
2	SAKSHI -R. CHAKUNDE	7842018801	sakshichakunde@gmail.com	Chakunde
3	Neha R. Vishwakarma	8983530173	Dehavisvishwakarma092003@gmail.com	Neha
4	Shelly L. Pandli	8329115980	shellypandli@gmail.com	Shelly
5	Prerna chodhary	9620384149	chauthanprerna2904@gmail.com	Prerna
6	Minal L. patte	9158070732	patteminal83@gmail.com	Minal
7	Aditi R. Vaidya	9075714591	aditivaidya619@gmail.com	Aditi
8	Shavani A. Sawdasani	9888437305	shavanayusudasani@gmail.com	Shavani
9	Ashwini N. Pandey	8308621072	ashwinipandey929@gmail.com	Ashwini
10	Gayatri V. Varma	9263287531	gayatrivarma0609@gmail.com	Gayatri

Signature of:

Programme In-Charge

IQAC COORDINATOR
INTERNAL QUALITY ASSURANCE CELL
DHARAMPETH M. P. DEO MEMORIAL
SCIENCE COLLEGE, NAGPUR

Principal
DHARAMPETH M. P. DEO MEMORIAL
SCIENCE COLLEGE, NAGPUR-440033



DHARAMPETH M. P. DEO MEMORIAL SCIENCE COLLEGE, NAGPUR
INTERNAL QUALITY ASSURANCE CELL (IQAC)

Activity Report

Date: 16/03/2023

Name of Organizing Department or Committee: Department of Microbiology

Name of the activity: Word puzzle on genetic engineering.

Suggested CRITERION point if any: II and V

Date of Activity: 16/03/2023

Place of Activity: Department of Microbiology Dharampeth MP Deo Memorial Science College, Nagpur

Name of Guest Speaker/s or Judge/s or Chief Guest/s if any: Nil

Title of the Activity: Word puzzle on genetic engineering on Paper II- unit I for semester VI students.

Number of Participants: 33

Name of the Teacher In-charge / Convener: Dr. Pratiksha V. Pohekar

Names of other Committee Members / Staff:

OUTCOME of the Activity with respect to mission vision of the institute and or academics:

- This syllabus based word puzzle are designed to promote, a fun way to study and in the process help improve students' knowledge.
- This puzzle competitions enables students to think from different angles or simply 'to think out of the box'.
- Students can do critical thinking, and get into a habit of innovative learning.
- This competition help students identify what they know and what they don't know

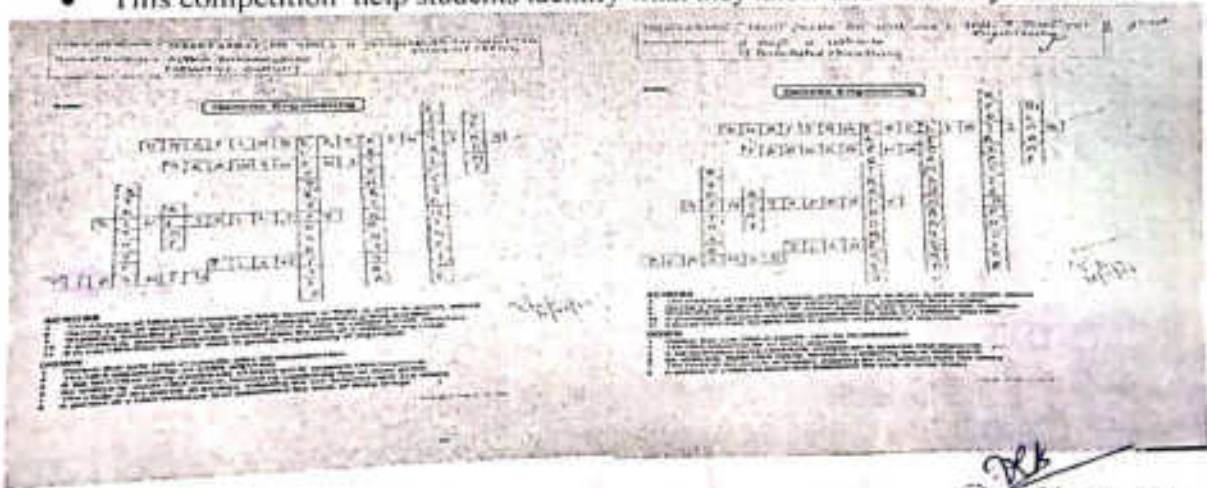

Name & Signature of Teacher In-charge
 Dr. Pratiksha V. Pohekar

Prof. Pitambar Humane

COORDINATOR
INTERNAL QUALITY ASSURANCE CELL
DHARAMPETH M. P. DEO MEMORIAL &
SCIENCE COLLEGE, NAGPUR

Dr. V. R. Nuthalkar
 HOD
 Deptt. of Microbiology
 Dharampeth M. P. Deo Memorial Science College, Nagpur

Dr. Akhilesh Peshwe

Principal
 Dharampeth M. P. Deo Memorial Science College, Nagpur



DATA VALIDATION & VERIFICATION (DVV)

Name of the Programme : Word Puzzle on genetic engineering
 Date of the Programme : 16/03/23 (Sem VI Students)
 Name of Chief Guest if any : _____
 Name of Guest Speaker if any : _____

Sr. No.	Name of the Participant	Mobile Number	E-mail Id	Signature
	Ayushi Shukla	9373668043	ayushishukla28112002@gmail.com	
	Madhura Bhondure	8767484914	madhurabhondure@gmail.com	
	Rinam C Wankhede	8010966529	wankhede.rinam@gmail.com	
	Sauviksha Choudhary	7517090406	csauvikshasauviksha@gmail.com	
	Sauviksha Kulkarni	9145253758	sauvikshakulkarni@gmail.com	
	Sayali Lokhande	9356413804	Sayalilokhande2910@gmail.com	
	Shreyansh S. Nairwar	7447844189	shreyanshnairwar1@gmail.com	
	Shiwani Dwivedi	8855900546	shiwaniidwivedi41@gmail.com	
	Krushnali Kodu	8625854995	krushnali.kodu@gmail.com	
	Juraf S. Jadhav	8767435158	Jurafshyambhadra82@gmail.com	
	Sanket K. Lode	7972085380	Sanketlode123@gmail.com	

Signature of:

Programme In-charge

IQAC Coordinator

Principal
Dharampeth M. P. Deo Memorial Science College, Nagpur



DATA VALIDATION & VERIFICATION (DVV)

Ishika S. Thakre	8010907069	ishithakre27@gmail	Ishika
Laxmi M. Gaud	778055514	laxmiguale2905@gmail	Laxmi
Nandini S. Hodge	9370301673	nandinihodge179@gmail.com	Nandini
Bhargavi A. Sambare	7709403806	bhargavisambare51@gmail.com	Bhargavi
Roshni M. Barmal	9325853408	rushni2018bb@gmail.com	Roshni
Anjali R. Pali	7498102109	palijali446@gmail.com	Anjali
Shruti Pawar	9527988707	shrutipawar@gmail.com	Shruti
Anushui Wele	8530778433	anushuiwele2001@gmail.com	Anushui
Bhumika D. Chedje	8830391103	bhumikachedje@gmail.com	Bhumika
Vivek R. Mahurwagh	8956482591	vivekramahurwagh@gmail.com	Vivek
Suman Singh	7249465307	missumansingh3@gmail.com	Suman
Manish Gade	9370329857	Manishgade79@gmail.com	Manish
Shardha Bhagat	7558367348	shardhabhagat45@gmail.com	Shardha
Athra Sakharade	9405197642	athrasakharade@gmail.com	Athra
Pranjali Dande	9325478218	pranjalidande@gmail.com	Pranjali
Avanti Chaphekar	7875173847	avanti1011@gmail.com	Avanti

Signature of:

Programme In-charge

IQAC Coordinator
CO ORDINATOR
INTERNAL QUALITY ASSURANCE CELL
DHARAMPETH M. P. DEO MEMORIAL &
SCIENCE COLLEGE, NAGPUR

Principal
Principal
Dharampeth M. P. Deo Memorial
Science College, Nagpur



DATA VALIDATION & VERIFICATION (DVV)

Tammy Y. Chaudhari	86000231	tchudhari1600@gmail.com	Tu
Aishwarya Joshi	7498328662	Aishwaryajoshi@gmail.com	Ash
Babaji Wadgaonkar	9420346682	babajiwadgaonkar@gmail.com	Babaji
Nandini P. Pournikar	9764359642	nandnipournikar@gmail.com	Nandini
Suhani P. Indurkar	9370419064	suhaniindurkar@gmail.com	Suhani
Pranjali N. Gaikwad	9130893362	gaikwadpranjali30@gmail.com	Pranjali

Signature of:

Shukar
Programme In-charge

[Handwritten Signature]

CO-ORDINATOR
INTERNAL QUALITY ASSURANCE CELL
DHARAMPETH M. P. DEO MEMORIAL &
SCIENCE COLLEGE, NAGPUR

Principal
Principal
Dharampeth M. P. Deo Memorial
Science College, Nagpur

Title of the Activity - Word Puzzle on Tools & Technique of Genetic Engineering

Name of Students - 1) Bhumika D. Chedge
 2) Vivek R. Wuhurwogh

Name:

Genetic Engineering

The crossword puzzle grid contains the following words:

- Across:**
 - 3. DNA FINGERPRINTING
 - 6. TRANSGENIC
 - 9. GENE THERAPY
 - 10. CLONE
 - 11. PLASMID
- Down:**
 - 1. RESTRICTION ENZYME
 - 2. BIOLOGY
 - 4. GEL
 - 5. ETHICS
 - 7. HUMAN
 - 8. ISSUES

Vivek
 16/3/23

ACROSS

- 3 The analysis of DNA from samples of body tissues or fluids in order to identify people
- 6 Having a mix of genes from two different species, combining their qualities
- 9 Replacing defective genes with normal genes in order to correct genetic disorders
- 10 A genetically identical organism created from the cells of a different organism
- 11 Circular DNA from bacteria used in genetic engineering of organisms

DOWN

- 1 Protein that cuts DNA at specific sites for recombination
- 2 The DNA sequence for an entire organism
- 4 A lab technique using electrically charged gel to separate DNA fragments
- 5 An artificially made DNA strand, formed by combining two or more genes
- 7 The study of the morals of biology, debating the line between right and wrong
- 8 A portion of a DNA molecule that determines the traits of living things



DHARAMPETH M. P. DEO MEMORIAL SCIENCE COLLEGE, NAGPUR

INTERNAL QUALITY ASSURANCE CELL (IQAC)

Activity Report

Date: 18th March 2023

Name of Organizing Department or Committee : Electronics Department

Name of the Activity : To study synchronous and asynchronous counter using datasheet.

Suggested CRITERION point if any : Suggested criteria II

Date of Activity : 18th March 2023

Place of Activity : Electronics Lab

Name of Guest Speaker/s or Judge/s or Chief Guest/s if any : Not applicable

Title of the Activity: To study synchronous and asynchronous counter using datasheet.

Based on Unit : 2(Paper II)

Class : Semester II

Number of Participants : 17

Name of the Teacher In-charge / Convener: Mrs. Leena P. Thakare

OUTCOME of the Activity with respect to mission vision of the institute and or academics:

Students studied pin diagram, features and applications of 74LS76 IC and 74197 IC.

Prof. Pitambar Humane
CO ORDINATOR
INTERNAL QUALITY ASSURANCE CELL
DHARAMPETH, M. P. DEO MEMORIAL &
SCIENCE COLLEGE, NAGPUR

Prof. Varsha V. Rangari
Dr. Varsha V. Rangari
Professor & Head
Department of Electronics
Dharampeth M.P. Deo Memorial
Science College, Nagpur

Dr. Akhlesh Peshwe
Principal
Dharampeth M.P. Deo Memorial
Science College, Nagpur.



DHARAMPETH M. P. DEO MEMORIAL SCIENCE COLLEGE, NAGPUR

Department of Electronics

Semester II- (2022-23)

Activity (Paper II- Unit- 2)

Sr. No.	Student Name	Mobile Number	Email ID
1	Tanu Ajay Singh	8806355808	tanusingh63492@gmail.com
2	Sandeep Rakesh Kumar Kumar	8081144948	sandeepk27900@gmail.com
3	Abhishek Ravindra Singh	8208948107	abhi0882005@gmail.com
4	Vedant Onkar Umretkar	9049932753	umretkarvedant@gmail.com
5	Tannu Arun Varthi	9322044903	tannuvarthi@gmail.com
6	Kashish Kamalkumar Bisen	7887886117	kashishbisen05@gmail.com
7	Aayushi Vikram Singh	9595119942	senxerox04@gmail.com
8	Valdhavi Baburao Gongal	7507907278	gayatrigongal787@gmail.com
9	Monali Narendraji Shende	7796516257	shendemonali92@gmail.com
10	Isha Ishwar Waghmare	8855919474	ishawaghmare9474@gmail.com
11	Simran Narendra Dhimole	8390347026	mishralaxmi210@gmail.com
12	Tejas Rajesh Chelmevar	9604662119	tejaschelmevar@gmail.com
13	Harshata Gunderao Warkhede	9860432428	bandukeshao20@gmail.com
14	Bhagyashali Dadarao Neware	7796434177	sakshineware2017@gmail.com
15	Khushbu Rajiv Pali	8459565214	palikhushbu59@gmail.com
16	Khushi Rajiv Pali	8767607224	palikhushi4@gmail.com

Name & Signature of Teacher In-Charge

Prof. Pitambar Humane
IQAC Coordinator

CO ORDINATOR
INTERNAL QUALITY ASSURANCE CELL
DHARAMPETH, M. P. DEO MEMORIAL &
SCIENCE COLLEGE, NAGPUR

Name & Signature of Head of the Department

Dr. Varsha V. Rangari
Professor & Head
Department of Electronics
Dharampeth M.P. Deo Memorial
Science College, Nagpur

Dr. Akhilesh Peshwe
Principal

Dharampeth M.P. Deo Memorial
Science College, Nagpur.

SN74LS76A

Dual JK Flip-Flop with Set and Clear

The SN74LS76A offers individual J, K, Clock Pulse, Direct Set and Direct Clear inputs. These dual flip-flops are designed so that when the clock goes HIGH, the inputs are enabled and data will be accepted. The Logic Level of the J and K inputs will perform according to the Truth Table as long as minimum set-up times are observed. Input data is transferred to the outputs on the HIGH-to-LOW clock transitions.

MODE SELECT - TRUTH TABLE

OPERATING MODE	INPUTS				OUTPUTS	
	S_D	C_D	J	K	Q	\bar{Q}
Set	L	H	X	X	H	L
Reset (Clear)	H	L	X	X	L	H
*Undetermined	L	L	X	X	H	H
Toggle	H	H	h	h	q	\bar{q}
Load "0" (Reset)	H	H	l	h	L	H
Load "1" (Set)	H	H	h	l	H	L
Hold	H	H	l	l	q	\bar{q}

* Both outputs will be HIGH while both S_D and C_D are LOW, but the output states are unpredictable if S_D and C_D go HIGH simultaneously.

H, h = HIGH Voltage Level

L, l = LOW Voltage Level

X = Don't Care

h, l (i) - Lower case letters indicate the state of the referenced input (or output) one setup time prior to the HIGH-to-LOW clock transition



ON Semiconductor

A Division of Motorola

<http://onsemi.com>

**LOW
POWER
SCHOTTKY**



PLASTIC
N SUFFIX
CASE 648



SOIC
D SUFFIX
CASE 751B

GUARANTEED OPERATING RANGES

Symbol	Parameter	Min	Typ	Max	Unit
V_{CC}	Supply Voltage	4.75	5.0	5.25	V
T_A	Operating Ambient Temperature Range	0	25	70	$^{\circ}$ C
I_{OH}	Output Current - High			-0.4	mA
I_{OL}	Output Current - Low			8.0	mA

ORDERING INFORMATION

Device	Package	Shipping
SN74LS76AN	16 Pin DIP	2000 Units/Box
SN74LS76AD	16 Pin	2500/Tape & Reel

SN74LS76A

PACKAGE DIMENSIONS

N SUFFIX
PLASTIC PACKAGE
CASE 648-08
ISSUE R

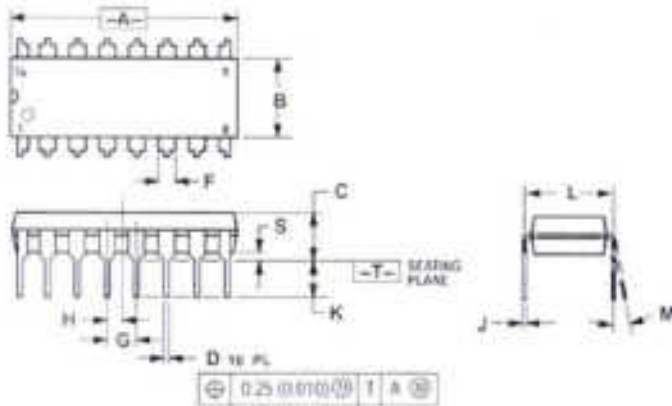

NOTES

1. DIMENSIONS AND TOLERANCES PER MILS UNLESS NOTED
2. CONTROLLING DIMENSION IS INCH
3. DIMENSIONS TO CENTER OF LEADS UNLESS NOTED OTHERWISE
4. DIMENSIONS IN PARENT PARENTHESIS INCLUDE MOLD FLASH
5. REFLOW CURVED LEADS ONLY

DIM	MILS		MILLIMETERS	
	MIN	MAX	MIN	MAX
A	0.132	0.130	3.35	3.30
B	0.262	0.270	6.75	6.87
C	0.145	0.175	3.67	4.44
D	0.075	0.081	1.91	2.05
F	0.065	0.100	1.65	2.54
H	0.100	0.100	2.54	2.54
J	0.060	0.060	1.52	1.52
K	0.110	0.110	2.79	2.79
L	0.170	0.200	4.30	5.08
M	0.1	0.1	2.54	2.54
S	0.050	0.050	1.27	1.27

D SUFFIX
PLASTIC SOIC PACKAGE
CASE 751B-05
ISSUE J

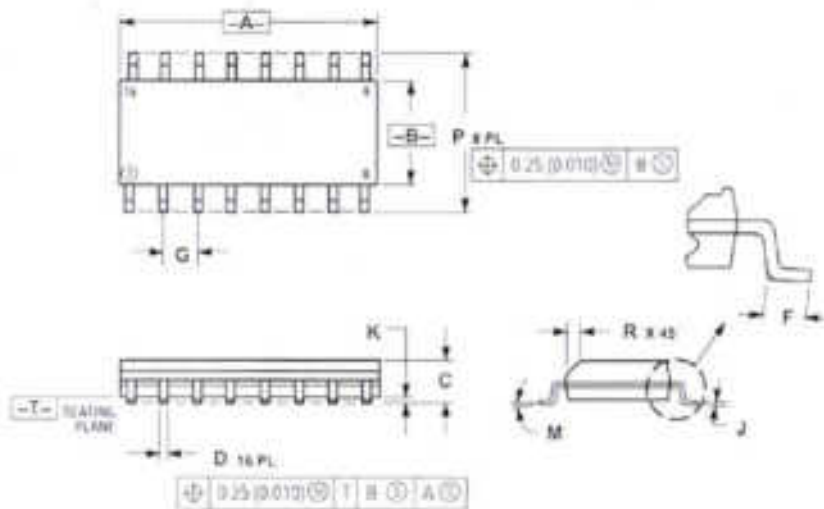

NOTES

1. DIMENSIONS AND TOLERANCES PER MILS UNLESS NOTED
2. CONTROLLING DIMENSION IS INCH
3. DIMENSIONS A AND B DO NOT INCLUDE MOLD PROTRUSIONS
4. MAXIMUM MOLD PROTRUSION IS 0.005 INCH PER SIDE
5. DIMENSIONS DO NOT INCLUDE COATED PROTRUSION. ALLOWABLE COATED PROTRUSION SHALL BE 0.005 INCH TOTAL AT ALL OF THE DIMENSIONS AT MANUFACTURING TOLERANCE

DIM	MILLIMETERS		MILS	
	MIN	MAX	MIN	MAX
A	6.35	6.60	250	260
B	2.00	4.00	78.7	157.5
C	0.75	1.75	29.5	68.8
D	0.75	1.40	29.5	55.5
F	0.50	1.25	19.7	49.8
G	1.27	2.00	50.0	78.7
J	0.75	0.75	29.5	29.5
K	0.75	0.75	29.5	29.5
M	0.75	0.75	29.5	29.5
R	1.40	4.00	55.5	157.5
T	0.75	0.75	29.5	29.5

SDL5077

**SN54196, SN54197, SN54LS196, SN54LS197, SN54S196, SN54S197,
SN74196, SN74197, SN74LS196, SN74LS197, SN74S196, SN74S197
50/30/100-MHz PRESETTABLE DECADE OR BINARY COUNTERS/LATCHES**

OCTOBER 1976—REVISED MARCH 1988

- Performs BCD, Bi-Quinary, or Binary Counting
- Fully Programmable
- Fully Independent Clear Input
- Input Clamping Diodes Simplify System Design
- Output Q_A Maintains Full Fan-out Capability In Addition to Driving Clock-2 Input

SN54196, SN54LS196, SN54S196,
SN54197, SN54LS197, SN54S197 . . . J OR W PACKAGE
SN74196, SN74197 . . . N PACKAGE
SN74LS196, SN74S196,
SN74LS197, SN74S197 . . . D OR N PACKAGE

(TOP VIEW)

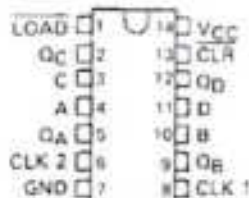

SN54LS196, SN54S196,
SN54LS197, SN54S197 . . . FK PACKAGE
(TOP VIEW)

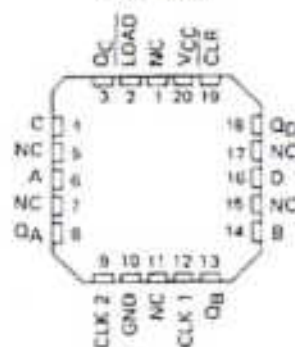

NC - No internal connection

TYPE	GUARANTEED COUNT FREQUENCY		TYPICAL POWER DISSIPATION
	CLOCK 1	CLOCK 2	
'196, '197	0-50 MHz	0-25 MHz	240 mW
'LS196, 'LS197	0-30 MHz	0-15 MHz	80 mW
'S196, 'S197	0-100 MHz	0-50 MHz	375 mW

description

These high-speed monolithic counters consist of four d-c-coupled, master-slave flip-flops, which are internally interconnected to provide either a divide-by-two and a divide-by-five counter ('196, 'LS196, 'S196) or a divide-by-two and a divide-by-eight counter ('197, 'LS197, 'S197). These four counters are fully programmable; that is, the outputs may be preset to any state by placing a low on the count/load input and entering the desired data at the data inputs. The outputs will change to agree with the data inputs independent of the state of the clocks.

During the count operation, transfer of information to the outputs occurs on the negative-going edge of the clock pulse. These counters feature a direct clear which when taken low sets all outputs low regardless of the states of the clocks.

These counters may also be used as 4-bit latches by using the count/load input as the strobe and entering data at the data inputs. The outputs will directly follow the data inputs when the count/load is low, but will remain unchanged when the count/load is high and the clock inputs are inactive.

All inputs are diode-clamped to minimize transmission-line effects and simplify system design. These circuits are compatible with most TTL logic families. Series 54, 54LS, and 54S circuits are characterized for operation over the full military temperature range of -55°C to 125°C. Series 74, 74LS, and 74S circuits are characterized for operation from 0°C to 70°C.

logic symbols†

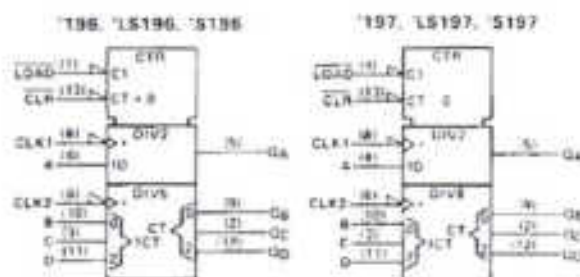

† These symbols are in accordance with ANSI/IEEE Std 91-1984 and IEC Publication 617-12.

Pin numbers shown are for D, J, N, and W packages.

PRODUCTION DATA documents contain information current as of publication date. Products conform to specifications per the terms of Texas Instruments standard warranty. Production processing does not necessarily include testing of all parameters.



POST OFFICE BOX 655312 • DALLAS, TEXAS 75265

SN54196, SN54197, SN74196, SN74197
50-MHz PRESETTABLE DECADE OR BINARY COUNTERS/LATCHES

absolute maximum ratings over operating free-air temperature range (unless otherwise noted)

Supply voltage, V_{CC} (see Note 1)	7 V
Input voltage	5.5 V
Intermitter voltage (see Note 2)	5.5 V
Operating free-air temperature range: SN54196, SN54197 Circuits	-55°C to 125°C
SN74196, SN74197 Circuits	0°C to 70°C
Storage temperature range	-65°C to 150°C

- NOTES: 1. Voltage values are with respect to network ground terminal.
 2. This is the voltage between two emitters of a multiple-emitter transistor. For this circuit, the rating applies between the Clear and Load inputs.

recommended operating conditions

		SN54196, SN54197			SN74196, SN74197			UNIT
		MIN	NOM	MAX	MIN	NOM	MAX	
Supply voltage, V_{CC}		4.5	5	5.5	4.75	5	5.25	V
High-level output current, I_{OH}					-800			μ A
Low-level output current, I_{OL}					16			mA
Count frequency	Clock-1 input	0	30		0	30		MHz
	Clock-2 input	0	25		0	25		
Pulse width, t_w	Clock-1 input	10			10			ns
	Clock-2 input	20			20			
	Clear	15			15			
Input hold time, t_h (see Note 3)	Load	20			20			ns
	High-level data	t_{wload}			t_{wload}			
Input setup time, t_{su} (see Note 3)	Low-level data	t_{wload}			t_{wload}			ns
	High-level data	10			10			
Count enable time, t_{en} (see Note 4)	Low-level data	15			15			ns
	High-level data	20			20			
Operating free-air temperature, T_A		-55			125			°C

- NOTES: 3. Setup and hold times are with respect to the falling edge of the load input.
 4. Minimum count enable time is the interval immediately preceding the negative-going edge of the clock pulse during which interval the countload and clear inputs must both be high to assure counting.

SN54LS196, SN54LS197, SN74LS196, SN74LS197 30-MHz PRESETTABLE DECADE OR BINARY COUNTERS/LATCHES

schematics of inputs and outputs

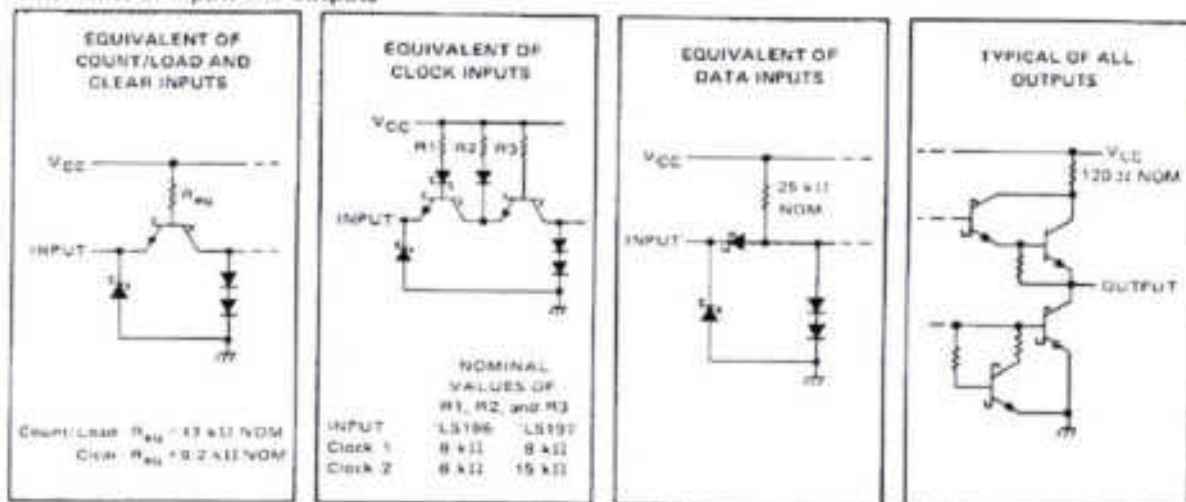

absolute maximum ratings over operating free-air temperature range (unless otherwise noted)

Supply voltage, V_{CC} (see Note 1)	7 V
Input voltage	5.5 V
Operating free-air temperature range: SN54LS196, SN54LS197 Circuits	-55°C to 125°C
SN74LS196, SN74LS197 Circuits	0°C to 70°C
Storage temperature range	-65°C to 150°C

NOTE 1: Voltage values are with respect to network ground terminal.

recommended operating conditions

		SN54LS196, SN54LS197			SN74LS196, SN74LS197			UNIT
		MIN	NOM	MAX	MIN	NOM	MAX	
V_{CC}	Supply voltage	4.5	5	5.5	4.75	5	5.25	V
I_{OH}	High-level output current			-400			-400	μ A
I_{OL}	Low-level output current			4			8	mA
Count frequency	Clock-1 input	0		30	0		20	MHz
	Clock-2 input	0		15	0		15	
t_{dr}	Clock-1 input	20			20			ns
	Clock-2 input	30			30			
	Clear	15			15			
	Load	20			20			
t_h	Input hold time (see Note 3)	$t_{w(\text{load})}$			$t_{w(\text{load})}$			ns
		$t_{w(\text{load})}$			$t_{w(\text{load})}$			
t_{su}	Input setup time (see Note 3)	High-level data			High-level data			ns
		Low-level data			Low-level data			
t_{en}	Count enable time (see Note 4)	Clock 1			Clock 1			ns
		Clock 2			Clock 2			
T_A	Operating free-air temperature	-55		125	0		70	°C

NOTES: 3. Setup and hold times are with respect to the falling edge of the load input.

4. Minimum count enable time is the interval immediately preceding the negative-going edge of the clock pulse during which interval the count/load and clear inputs must both be high to ensure counting.

**TEXAS
INSTRUMENTS**

FIRST OFFICE Bldg. 545911 • DALLAS, TEXAS 75220

SN54S196, SN54S197, SN74S196, SN74S197 100-MHz PRESETTABLE DECADE OR BINARY COUNTERS/LATCHES

schematics of inputs and outputs

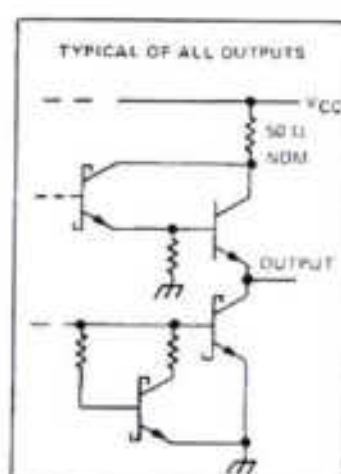
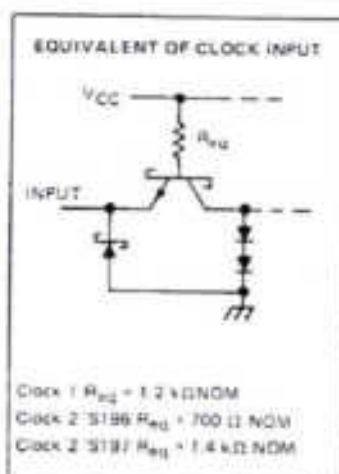
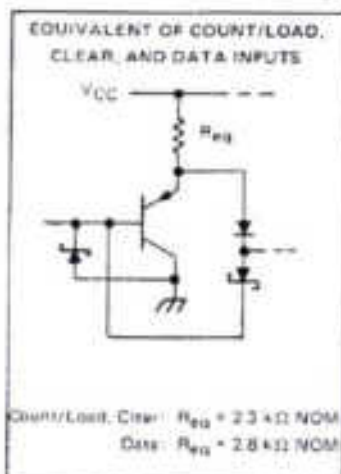

absolute maximum ratings over operating free-air temperature range (unless otherwise noted)

Supply voltage, V_{CC} (see Note 1)	7 V
Input voltage	5.5 V
Operating free-air temperature range: SN54S196, SN54S197 Circuits	-55°C to 125°C
SN74S196, SN74S197 Circuits	0°C to 70°C
Storage temperature range	-65°C to 150°C

NOTE 1: Voltage values are with respect to network ground terminal.

recommended operating conditions

	SN54S196, SN54S197			SN74S196, SN74S197			UNIT
	MIN	NOM	MAX	MIN	NOM	MAX	
Supply voltage, V_{CC}	4.5	5	5.5	4.75	5	5.25	V
High-level output current, I_{OH}			-1			-1	mA
Low-level output current, I_{OL}			20			20	mA
Clock frequency	Clock-1 input	0	100	0		100	MHz
	Clock-2 input	0	50	0		50	
Pulse width, t_p	Clock-1 input	5		5			ns
	Clock-2 input	10		10			
	Clear	20		20			
	Load	5		5			
Input hold time, t_H (see Note 3)	High-level data	31		31			ns
	Low-level data	31		31			
Input setup time, t_{SU} (see Note 3)	High-level data	61		61			ns
	Low-level data	61		61			
Count enable time, t_{EN} (see Note 4)		12		12			ns
Operating free-air temperature, T_A	-55		125	0		70	°C

NOTES: 3. Setup and hold times are with respect to the falling edge of the load input.

4. Minimum count enable time is the interval immediately preceding the negative-going edge of the clock pulse during which interval the count/load and clear inputs must both be high to ensure counting.

SN54S196, SN54S197, SN74S196, SN74S197
100-MHz PRESETTABLE DECADE OR BINARY COUNTERS/LATCHES

Electrical characteristics over recommended operating free-air temperature range (unless otherwise noted)

PARAMETER	TEST CONDITIONS †	SN54S196, SN74S196		SN54S197, SN74S197		UNIT	
		MIN	TYP ‡	MAX	MIN		TYP ‡
V_{OH}		2		2		V	
V_{OL}		0.8		0.8		V	
V_{IK}	$V_{CC} = \text{MIN.}$ $I_I = -18 \text{ mA}$	-1.2		-1.2		V	
V_{OH}	$V_{CC} = \text{MIN.}$ $V_{IH} = 2 \text{ V.}$ $V_{IL} = 0.8 \text{ V.}$ $I_{OH} = -1 \text{ mA}$	54S	2.5	3.4	2.5	3.4	V
		74S	2.7	3.4	2.7	3.4	
V_{OL}	$V_{CC} = \text{MIN.}$ $V_{IH} = 2 \text{ V.}$ $V_{IL} = 0.8 \text{ V.}$ $I_{OL} = 20 \text{ mA} †$	0.5		0.5		V	
I_I	$V_{CC} = \text{MAX.}$ $V_I = 0.5 \text{ V}$	1		1		mA	
I_{IH}	Clock 1, clock 2	150		150		μA	
	All other inputs	50		50			
I_{IL}	Data, Load, Clear	-0.75		-0.75		mA	
	Clock 1	-8		-8			
	Clock 2	-10		-6			
$I_{OS} ‡$	$V_{CC} = \text{MAX.}$	-70	-110	-20	-110	mA	
I_{CC}	$V_{CC} = \text{MAX.}$ See Note 5	54S	75	110	75	110	mA
		74S	75	120	75	120	

† For conditions shown as MIN or MAX, use the appropriate value specified under recommended operating conditions.

‡ All typical values are at $V_{CC} = 5 \text{ V.}$ $T_A = 25^\circ\text{C.}$

§ I_{OH} outputs are tested at $I_{OL} = 20 \text{ mA}$ plus the limit value of I_{IL} for the clock-2 input. This permits driving the clock-2 input while turning out to 10 Series 54S/74S loads.

¶ Not more than one output should be shorted at a time, and duration of the short circuit should not exceed one second.

NOTE 5: I_{CC} is measured with all input grounded and all outputs open.

switching characteristics, $V_{CC} = 5 \text{ V.}$ $T_A = 25^\circ\text{C}$

PARAMETER*	FROM (INPUT)	TO (OUTPUT)	TEST CONDITIONS	SN54S196, SN74S196		SN54S197, SN74S197		UNIT
				MIN	TYP	MAX	MIN	
f_{max}	Clock 1	Q_A	$R_L = 280 \Omega.$ $C_L = 15 \text{ pF.}$ See Note 7	100	140	100	140	MHz
t_{PLH}	Clock 1	Q_A		5	10	5	10	ns
t_{PHL}				5	10	5	10	
t_{PLH}	Clock 2	Q_B		5	10	5	10	ns
t_{PHL}				8	12	8	12	
t_{PLH}	Clock 2	Q_C		12	18	12	18	ns
t_{PHL}				16	24	15	22	
t_{PLH}	Clock 2	Q_D		5	10	18	27	ns
t_{PHL}				8	12	22	33	
t_{PLH}	A, B, C, D	Q_A, Q_B, Q_C, Q_D		7	12	7	12	ns
t_{PHL}				12	18	12	18	
t_{PLH}	Load	Any		10	18	10	18	ns
t_{PHL}				12	18	12	18	
t_{PHL}	Clear	Any		26	37	26	37	ns

* f_{max} = maximum count frequency.

t_{PLH} = propagation delay time, low-to-high-level output.

t_{PHL} = propagation delay time, high-to-low-level output.

NOTE 7: Load circuit, input conditions, and voltage waveforms are the same as those shown in Section 1.

SN54LS196, SN54LS197, SN74LS196, SN74LS197
30-MHz PRESETTABLE DECADE OR BINARY COUNTERS/LATCHES

electrical characteristics over recommended operating free-air temperature range (unless otherwise noted)

PARAMETER		TEST CONDITIONS ¹	SN54LS196		SN74LS196		UNIT		
			SN54LS197	MIN	TYP ²	MAX		MIN	TYP ²
V _{IH} High-level input voltage			2			2		V	
V _{IL} Low-level input voltage				0.7			0.9	V	
V _{IK} Input clamp voltage		V _{CC} = MIN, I _I = -18 mA		-1.5			-1.5	V	
V _{OH} High-level output voltage		V _{CC} = MIN, V _{IH} = 2 V, V _{IL} = V _{IL max} , I _{OH} = -400 μ A	2.6	3.4		2.7	3.4	V	
V _{OL} Low-level output voltage		V _{CC} = MIN, V _{IH} = 2 V, V _{IL} = V _{IL max}	0.25	0.4		0.25	0.4	V	
I _I Input current at maximum input voltage	Data, Load	V _{CC} = MAX, V _I = 5.5 V		0.1			0.1	mA	
	Clear, clock 1			0.2		0.2			
	Clock 2 of 'LS196			0.4		0.4			
	Clock 2 of 'LS197			0.3		0.2			
I _{IH} High-level input current	Data, Load	V _{CC} = MAX, V _I = 2.7 V		20			20	μ A	
	Clear, clock 1			40		40			
	Clock 2 of 'LS196			80		80			
	Clock 2 of 'LS197			40		40			
I _{IL} Low-level input current	Data, Load	V _{CC} = MAX, V _I = 0.4 V		-0.4			-0.4	mA	
	Clear			-0.8		-0.8			
	Clock 1			-2.4		-2.4			
	Clock 2 of 'LS196			-2.8		-2.8			
	Clock 2 of 'LS197			-1.3		-1.3			
I _{OS} Short-circuit output current ³		V _{CC} = MAX	-20	-100		-20	-100	mA	
I _{CC} Supply current		V _{CC} = MAX, See Note 5		16	27		16	27	mA

¹ For conditions shown as MIN or MAX, use the appropriate value specified under recommended operating conditions.

² All typical values are at V_{CC} = 5 V, T_A = 25°C.

³ Not more than one output should be shorted at a time, and duration of the short-circuit should not exceed one second.

⁴ Q_A outputs are tested at specified I_{OL} plus the limit value of I_{IL} for the clock 2 input. This permits driving the clock 2 input while maintaining full fan-out capability.

NOTE 5: I_{CC} is measured with all inputs grounded and all outputs open.

switching characteristics, V_{CC} = 5 V, T_A = 25°C

PARAMETER #	FROM (INPUT)	TO (OUTPUT)	TEST CONDITIONS	SN54LS196		SN54LS197		UNIT	
				SN74LS196	MIN	TYP	MAX		MIN
f _{max}	Clock 1	Q _A	C _L = 15 pF, R _L = 2 k Ω , See Note 6	30	40		30	40	MHz
t _{PLH}	Clock 1	Q _A		8	15		8	15	ns
t _{PHL}				13	20		14	21	
t _{PLH}	Clock 2	Q _B		16	24		12	19	ns
t _{PHL}				22	33		23	35	
t _{PLH}	Clock 2	Q _C		28	57		24	51	ns
t _{PHL}				41	62		42	63	
t _{PLH}	Clock 2	Q _D		12	18		55	78	ns
t _{PHL}				30	45		63	95	
t _{PLH}	A, B, C, D	Q _A , Q _B , Q _C , Q _D		20	30		18	27	ns
t _{PHL}				29	44		29	44	
t _{PLH}	Low	Any		27	41		26	39	ns
t _{PHL}				30	45		30	45	
t _{PHL}	Clear	Any		34	51		34	51	ns

f_{max} = maximum count frequency

t_{PLH} = propagation delay time, low-to-high-level output, t_{PHL} = propagation delay time, high-to-low-level output

NOTE 6: Load circuit, input conditions, and voltage waveforms are the same as those shown for the '176, '177 except that t_I = 15 ns, t_H = 6 ns, and V_{Iref} = 1.3 V (as opposed to 1.5 V).

TEXAS
INSTRUMENTS

POST OFFICE BOX 655012 • DALLAS, TEXAS 75265

SN54196, SN54197, SN74196, SN74197
50-MHz PRESETTABLE DECADE OR BINARY COUNTERS/LATCHES

electrical characteristics over recommended operating free-air temperature range (unless otherwise noted)

PARAMETER	TEST CONDITIONS ¹	SN54196, SN74196			SN54197, SN74197			UNIT
		MIN	TYP ²	MAX	MIN	TYP ²	MAX	
V _{IH} High-level input voltage		2			2			V
V _{IL} Low-level input voltage				0.8			0.8	V
V _{IC} Input clamp voltage	V _{CC} = MIN, I _I = -12 mA			-1.5			-1.5	V
V _{OH} High-level output voltage	V _{CC} = MIN, V _{IH} = 2 V, V _{IL} = 0.8 V, I _{OH} = -800 μ A	2.4	2.4		2.4	2.4		V
V _{OL} Low-level output voltage	V _{CC} = MIN, V _{IH} = 2 V, V _{IL} = 0.8 V, I _{OL} = 16 mA ³		0.2	0.4		0.2	0.4	V
I _I Input current at maximum input voltage	V _{CC} = MAX, V _I = 5.5 V			1			1	mA
I _{IH} High-level input current	Data, Load			45			40	μ A
	Clear, clock 1	V _{CC} = MAX, V _I = 2.4 V						
	Clock 2			80			80	
I _{IL} Low-level input current	Data, Load			-1.5			-1.5	mA
	Clear	V _{CC} = MAX, V _I = 0.4 V						
	Clock 1			-3.2			-3.2	
	Clock 2			-4.8			-4.8	
I _{OS} Short-circuit output current ⁴	V _{CC} = MAX	SN54 ¹	-20	-57	-20	-57		mA
		SN74 ¹	-18	-57	-18	-57		
I _{CC} Supply current	V _{CC} = MAX, See Note 5		48	55		48	50	mA

NOTE 5: I_{CC} is measured with all inputs grounded and all outputs open.

¹For conditions shown as MIN or MAX, use the appropriate value specified under recommended operating conditions.

²All typical values are at V_{CC} = 5 V, T_A = 25°C.

³Not more than one output should be shorted at a time.

⁴QA outputs are tested at I_{OL} = 16 mA plus the limit value of I_I for the clock-2 input. This permits driving the clock-2 input while fanning out to 10 Series 54/74 loads.

switching characteristics, V_{CC} = 5 V, T_A = 25°C

PARAMETER #	FROM (INPUT)	TO (OUTPUT)	TEST CONDITIONS	SN54196 SN74196			SN54197 SN74197			UNIT
				MIN	TYP	MAX	MIN	TYP	MAX	
f _{max}	Clock 1	QA	C _L = 15 pF, R _L = 400 Ω , See Note 6	50	70		50	70		MHz
t _{PLH}	Clock 1	QA		7	12		7	12		ns
t _{PHL}				10	15		10	15		
t _{PLH}	Clock 2	Qg		12	18		12	18		ns
t _{PHL}				14	21		14	21		
t _{PLH}	Clock 2	QC		24	36		24	36		ns
t _{PHL}				28	42		28	42		
t _{PLH}	Clock 2	QD		14	21		26	54		ns
t _{PHL}				12	18		42	63		
t _{PLH}	A, B, C, D	QA, Qg, QC, QD		10	24		10	24		ns
t _{PHL}				25	38		25	38		
t _{PLH}	Load	Any		22	32		22	32		ns
t _{PHL}				24	36		24	36		
t _{PHL}	Clear	Any		25	37		25	37		ns

[#]f_{max} = maximum count frequency.

t_{PLH} = propagation delay time, low-to-high-level output.

t_{PHL} = propagation delay time, high-to-low-level output.

NOTE 6: Load circuit, input conditions, and voltage waveforms are the same as those shown for the '176, '177 except that testing f_{max}, V_{IL} = 0.3 V.

TEXAS
INSTRUMENTS

POST OFFICE BOX 655312 • DALLAS, TEXAS 75265

**SN54196, SN54197, SN54LS196, SN54LS197, SN54S196, SN54S197,
SN74196, SN74197, SN74LS196, SN74LS197, SN74S196, SN74S197
50/30/100-MHz PRESETTABLE DECADE OR BINARY COUNTERS/LATCHES**

typical count configurations

'196, 'LS196, and 'S196 typical count configurations and function tables are the same as those for '176.
'197, 'LS197, and 'S197 typical count configurations and function tables are the same as those for '177.

logic diagrams

'196, 'LS196, and 'S196 logic diagrams are the same as those for '176.
'197, 'LS197, and 'S197 logic diagrams are the same as those for '177.

schematics of inputs and outputs

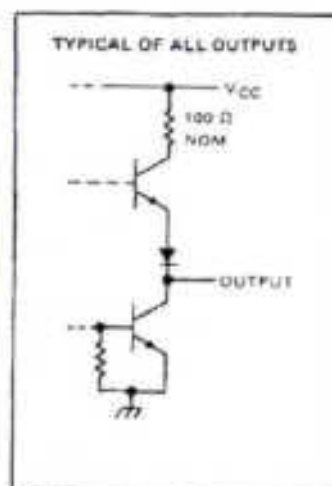
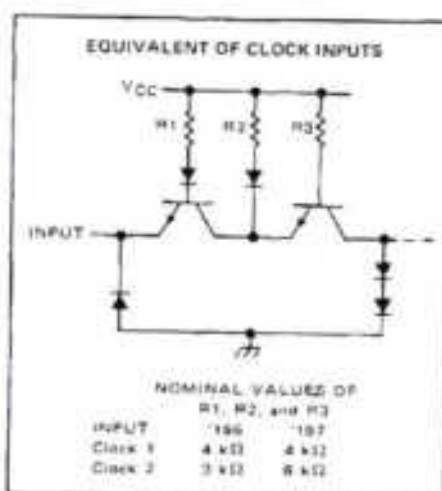
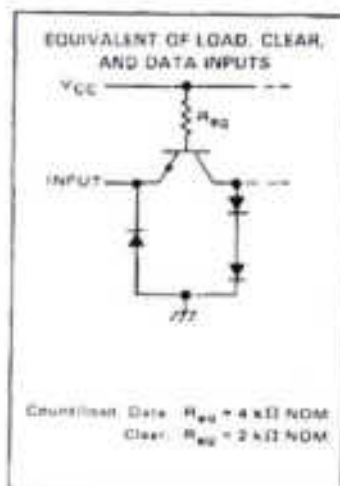



SN74LS76A

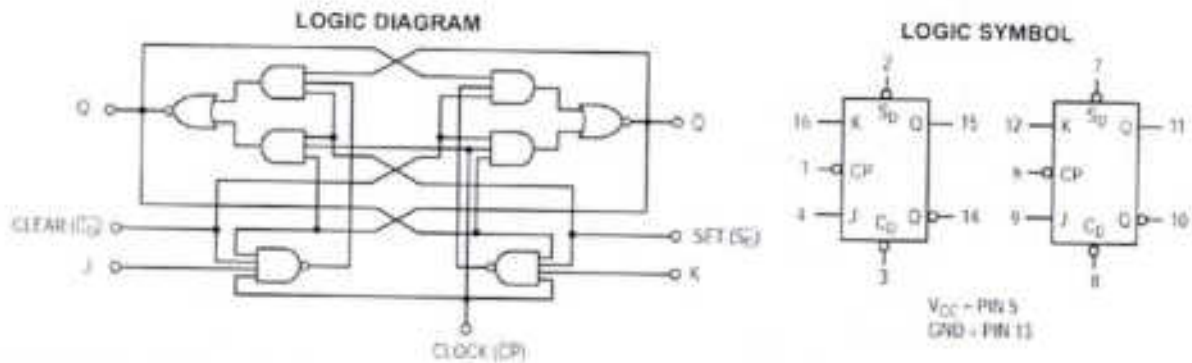

DC CHARACTERISTICS OVER OPERATING TEMPERATURE RANGE (unless otherwise specified)

Symbol	Parameter	Limits			Unit	Test Conditions
		Min	Typ	Max		
V_{IH}	Input HIGH Voltage	2.0			V	Guaranteed input HIGH Voltage for All inputs
V_{IL}	Input LOW Voltage			0.8	V	Guaranteed Input LOW Voltage for All inputs
V_{IK}	Input Clamp Diode Voltage		-0.65	-1.5	V	$V_{CC} = \text{MIN}$, $I_{IK} = -18 \text{ mA}$
V_{OH}	Output HIGH Voltage	2.7	3.5		V	$V_{CC} = \text{MIN}$, $I_{OH} = \text{MAX}$, $V_{IK} = V_{IH}$ or V_{IL} per Truth Table
V_{OL}	Output LOW Voltage		0.25	0.4	V	$I_{OL} = 4.0 \text{ mA}$
			0.35	0.5	V	$I_{OL} = 8.0 \text{ mA}$
I_{IH}	Input HIGH Current	J, K Clear Clock		20 60 80	μA	$V_{CC} = \text{MAX}$, $V_{IK} = 2.7 \text{ V}$
		J, K Clear Clock		0.1 0.3 0.4	mA	$V_{CC} = \text{MAX}$, $V_{IK} = 7.0 \text{ V}$
		J, K Clear, Clock		-0.4 -0.8	mA	$V_{CC} = \text{MAX}$, $V_{IK} = 0.4 \text{ V}$
I_{IL}	Input LOW Current				mA	$V_{CC} = \text{MAX}$, $V_{IK} = 0.4 \text{ V}$
I_{OC}	Short Circuit Current (Note 1)	-20		-100	mA	$V_{CC} = \text{MAX}$
I_{CC}	Power Supply Current			5.0	mA	$V_{CC} = \text{MAX}$

Note 1: Not more than one output should be shorted at a time, nor for more than 1 second.

AC CHARACTERISTICS ($T_A = 25^\circ\text{C}$, $V_{CC} = 5.0 \text{ V}$)

Symbol	Parameter	Limits			Unit	Test Conditions
		Min	Typ	Max		
f_{MAX}	Maximum Clock Frequency	30	45		MHz	$V_{CC} = 5.0 \text{ V}$ $C_L = 15 \text{ pF}$
t_{PLH} t_{PHL}	Clock, Clear, Set to Output		15	20	ns	
			15	20	ns	

AC SETUP REQUIREMENTS ($T_A = 25^\circ\text{C}$)

Symbol	Parameter	Limits			Unit	Test Conditions
		Min	Typ	Max		
t_{WH}	Clock Pulse Width High	20			ns	$V_{CC} = 5.0 \text{ V}$
t_{WL}	Clear/Set Pulse Width	25			ns	
t_s	Setup Time	20			ns	
t_h	Hold Time	0			ns	



DHARAMPETH M. P. DEO MEMORIAL SCIENCE COLLEGE, NAGPUR

INTERNAL QUALITY ASSURANCE CELL (IQAC)

Activity Report

Date: 18th March 2023

Name of Organizing Department or Committee : Electronics Department

Name of the Activity : Error finding in C Program

Suggested CRITERION point if any : Suggested criteria II

Date of Activity : 18th March 2023

Place of Activity : Electronics Lab

Name of Guest Speaker/s or Judge/s or Chief Guest/s if any : Not applicable

Title of the Activity: Error finding in C Program

Based on Unit : 2(Paper 1)

Class : Semester VI

Number of Participants : 17

Name of the Teacher In-charge / Convener: Mrs. Leena P. Thakare

OUTCOME of the Activity with respect to mission vision of the institute and or academics:

To familiarize the students with the syntax of control statements in C programming. They also learn how to point out errors in the programming code.

Prof. Pitambar Humane

COORDINATOR

INTERNAL QUALITY ASSURANCE CELL
DHARAMPETH, M. P. DEO MEMORIAL &
SCIENCE COLLEGE, NAGPUR

Dr. Varsha V. Rangari
Professor & Head
Head of the Department
Department of Electronics
Dharampeth M.P. Deo Memorial
Science College, Nagpur

Dr. Akhilesh Peshwe

Principal
Dharampeth M.P. Deo Memorial
Science College, Nagpur.



DHARAMPETH M. P. DEO MEMORIAL SCIENCE COLLEGE, NAGPUR

Department of Electronics

Semester VI- (2022-23)

Activity (Paper II- Unit- I)

Sr. No.	Student Name	Mobile Number	Email Id
1	Aarti Brijkishor Singh	7709208740	aartibsingh222@gmail.com
2	Sakshi Sanjay Huddar	9405142450	huddarmahi@gmail.com
3	Tanmay Sunil Gadam	7262034396	tanmaygadaml@gmail.com
4	Samiksha Vasant Tabhane	9307133863	samikshavtabhane@gmail.com
5	Riddhi Abhay Rajkarne	8669809201	riddhirajkarne@gmail.com
6	Rani Devidas Kokate	7998945148	ranikokate1009@gmail.com
7	Bhavesh Rameshwar Maske	7489951631	bhaveshmaske2002@gmail.com
8	Megha Tribhuwan Bisen	9637770341	bisenmegha320@gmail.com
9	Kiran Ramesh Waghade	9860218676	rameshwaghade20@gmail.com
10	Sagar Omprakash Sonwane	9356591564	sagarsonwane706@gmail.com
11	Ankita Laxman Sonwane	9284801790	ankitasonwane10@gmail.com
12	Ankit Dilip Singh	9307189124	as4212892@gmail.com
13	Adesh Kamalkishor Dubey	9527898267	Adesh222@gmail.com
14	Ankur Singh	7507990175	akashdsingh059@gmail.com
15	Prathmesh Sanju Badhiye	9765262138	nikita24badhiye@gmail.com

Name & Signature of Teacher In-Charge

Name & Signature of Head of the Department

Prof. Pitambar Humane
IQAC Coordinator

CO ORDINATOR

INTERNAL QUALITY ASSURANCE CELL
DHARAMPETH M. P. DEO MEMORIAL &
SCIENCE COLLEGE, NAGPUR

Dr. Varsha V. Rangari
Professor & Head
Department of Electronics
Dharampeth M.P. Deo Memorial
Science College, Nagpur

Dr. Anandesh Peshwe
Principal

Principal
Dharampeth M.P. Deo Memorial
Science College, Nagpur.

WORKSHEET : Error finding in C Program

Point out the errors, if any, in the following C statements:

- (a) `int = 314.562 * 150 ;`
- (b) `name = 'Ajay' ;`
- (c) `varchar = '3' ;`
- (d) `3.14 * r * r * h = vol_of_cyl ;`
- (e) `k = (a * b) (c + (2.5a + b) (d + e) ;`
- (f) `m_inst = rate of interest * amount in rs ;`
- (g) `si = principal * rateofinterest * numberofyears / 100 ;`
- (h) `area = 3.14 * r ** 2 ;`
- (i) `volume = 3.14 * r ^ 2 * h ;`
- (j) `k = ((a * b) + c) (2.5 * a + b) ;`
- (k) `a = b = 3 = 4 ;`
- (l) `count = count + 1 ;`
- (m) `date = '2 Mar 04' ;`

Point out the errors, if any, in the following programs:

```
(a) main( )
{
float a = 12.25, b = 12.52 ;
if ( a = b )
printf ( "\na and b are equal" );
}
```

```
(b) main( )
{
int j = 10, k = 12 ;
if ( k >= j )
{
{
k = j ; j = k ;
}
}
}
```

```
(c) main( )
{
if ( 'X' < 'x' )
printf ( "\nascii value of X is smaller than that of x" );
}
```

```
(d) main( )
{
int x = 10 ;
if ( x >= 2 )
then printf ( "\n%d", x );
}
```

```
e) main( )
{
int x = 30 , y = 40 ;
if ( x == y )
printf( "x is equal to y" );
elseif ( x > y )
printf( "x is greater than y" );
}
```

Point out the errors, if any, in the following programs:

```
a) /* This program */ is an example of /* using Logical operators */
main()
{
int i = 2, j = 5;
if ( i == 2 && j == 5 )
printf ( "\nSatisfied at last" );
}
```

```
b) main()
{
int code, flag;
if ( code == 1 & flag == 0 )
printf ( "\nThe eagle has landed" );
}
```

```
c) main()
{
char spy = 'a', password = 'z';
if ( spy == 'a' or password == 'z' )
printf ( "\nAll the birds are safe in the nest" );
}
```

```
(d) main()
{
int x = 10, y = 20;
if ( x >= 2 and y <= 50 )
printf ( "\n%d", x );
}
```

```
(e) main()
{
int a, b;
if ( a == 1 & b == 0 )
printf ( "\nGod is Great" );
}
```

```
(f) main()
{
int x = 2;
if ( x == 2 && x != 0 );
{
printf ( "\nHi" ); printf( "\nHello" );
}
else printf( "Bye" );
}
```



DHARAMPETH M. P. DEO MEMORIAL SCIENCE COLLEGE, NAGPUR
INTERNAL QUALITY ASSURANCE CELL (IQAC)

NEP Activity Report

Date : 28/3/23

Name of Organizing Department or Committee: Department of Chemistry

Name of the activity: NEP Activity Home Science Sem II unit IV

Suggested CRITERION point if any: Criteria II

Date of Activity: 18/3/23

Place of Activity: Home Science Department 2nd floor

Name of Guest Speaker/s or Judge/s or Chief Guest/s if any: Nil

Title of the Activity: How painting protect corrosion

Number of Participants: 8

Name of the Teacher In-charge / Convener: Dr. Sandip Madhukar Bhiwagade

Names of other Committee Members / Staff: Dr. Vaishali P. Meshram

OUTCOME of the Activity with respect to mission vision of the institute and or academics:

In this activity students learn about corrosion. How metals get corroded due to oxidation process when they are present in environmental condition. But when metal gets painted how this layer of paint on metal surface inhibit the oxidation process by cutting the contact of metal surface and water molecule present in environment

Activity with newspaper coverage if any : Nil

Activity data save in PC of: Department of Chemistry



Dr. Sandip Bhiwagade
SB

Prof. Pitambar Humane

Prof. Pitambar Humane
IQAC Coordinator

CO ORDINATOR
INTERNAL QUALITY ASSURANCE CELL
DHARAMPETH, M. P. DEO MEMORIAL &
SCIENCE COLLEGE, NAGPUR

Name & Signature of Teacher In-charge

Dr. Akhilesh Peshwe
Dr. Akhilesh Peshwe
Principal
PRINCIPAL

Dharampeth M.P. Deo Memorial
Science College, Nagpur-440033



DHARAMPETH M. P. DEO MEMORIAL SCIENCE COLLEGE,
North Ambazari Road, Near Ambazari Lake, Nagpur-440033

DATA VALIDATION & VERIFICATION (DVV)

Name of the Programme : How painting protect corrosion
Date of the Programme : 18/3/2023
Name of Chief Guest if any : _____
Name of Guest Speaker if any : _____

Sr. No.	Name of the Participant	Mobile Number	E-mail Id	Signature
1.	Ashwini N. Pandey	8508621072	ashwinipandey89@gmail.com	
2.	Aditi R. Vaidya	9075714591	aditivaidya619@gmail.com	
3.	Bhavona Gurusdasari	5888437303	bhavonagurusdasari@gmail.com	
4.	Minal L. Patle	9158070732	patleminal83@gmail.com	
5.	Shalu Pardihi	8329115380	shalupardihi@gmail.com	
6.	Neha L. Subant	9057167848	nehasubant@gmail.com	
7.	Neha R. Vishwakarma	8985534173	nehavishwakarma5225@gmail.com	
8.	SAKSHI R. CHAKUNDE	7843018801	sakshichakunde@gmail.com	

Signature of:
Programme In-charge

ICAC COORDINATOR
INTERNAL QUALITY ASSURANCE CELL
DHARAMPETH M. P. DEO MEMORIAL &
SCIENCE COLLEGE, NAGPUR

Principal
PRINCIPAL
Dharampeth M. P. Deo Memorial
Science College, Nagpur-440033



DHARAMPETH M. P. DEO MEMORIAL SCIENCE COLLEGE, NAGPUR
INTERNAL QUALITY ASSURANCE CELL (IQAC)

Activity Report

Date : 28/3/23

Name of Organizing Department or Committee: Department of Chemistry

Name of the activity: NEP Activity Home science Sem IV Unit III

Suggested CRITERION point if any: Criteria II

Date of Activity: 18/3/2023

Place of Activity: Room No 9

Name of Guest Speaker/s or Judge/s or Chief Guest/s if any: Nil

Title of the Activity: Preparation of Aspirin

Number of Participants: 10

Name of the Teacher In-charge / Convener: Dr. Sandip Madhukar Bhiwagade

Names of other Committee Members / Staff: Dr. Vaishali P. Meshram

OUTCOME of the Activity with respect to mission vision of the institute and or academics:

This activity helps to understand students how to prepared simple drugs like aspirin by using simple chemicals like salicylic acid. Students also learned the uses of aspirin and side effect of aspirin.

Activity with newspaper coverage if any : Nil

Activity data save in PC of: Department of Chemistry



Dr. Sandip Bhiwagade

Name & Signature of Teacher In-charge

Prof. Pitambar Humane
IQAC Coordinator

CO ORDINATOR
INTERNAL QUALITY ASSURANCE CELL
DHARAMPETH, M. P. DEO MEMORIAL &
SCIENCE COLLEGE, NAGPUR

Dr. Akhilesh Peshwe
Principal

PRINCIPAL
Dharampeth M.P. Deo Memorial
Science College, Nagpur-440033



DHARAMPETH M. P. DEO MEMORIAL SCIENCE COLLEGE,
North Ambazari Road, Near Ambazari Lake, Nagpur- 440033

DATA VALIDATION & VERIFICATION (DVV)

Name of the Programme : Preparation of Aspirin
Date of the Programme : 18/3/2023
Name of Chief Guest if any : _____
Name of Guest Speaker if any : _____

Sr. No.	Name of the Participant	Mobile Number	E-mail Id	Signature
1)	Pranali Ghongarkar	9309079427	Pranali02@gmail.com	Pranali
2)	Bhagyashree S. Ambule	9957139068	ambuleb667@gmail.com	Ambule
3)	Tannu S. Korde	7841984450	kordetannu13x@gmail.com	Korde
4)	Kimaya. N. Kale	9366073792	kimayakale@gmail.com	Kimaya
5)	Poochi. N. Lakkar	9906246419	Pachilakkar159@gmail.com	Poochi
6)	Pallavi Katre	8459277408	PKatre573@gmail.com	Pallavi
7)	Priyanka S. Tiwari	6394098386	Priyankatiwari14052002@gmail.com	Priyanka
8)	Ajani Wankhede	8767699751	wankhedeajani@gmail.com	Ajani
9)	Aruni Shenuai	9096507459	Arunishenuai5@gmail.com	Aruni
10)	Sujata Kawase	917545202	sujatakawase10@gmail.com	Skawase

Signature of:

Programme In-charge

IQAC Coordinator

DHARAMPETH M. P. DEO MEMORIAL &
SCIENCE COLLEGE, NAGPUR

PRINCIPAL

Dharampeth M.P. Deo Memorial
Science College, Nagpur-440033



DHARAMPETH M. P. DEO MEMORIAL SCIENCE COLLEGE, NAGPUR

INTERNAL QUALITY ASSURANCE CELL (IQAC)

Activity Report

Date: 20-03-2023

Name of Organizing Department or Committee: Department of Statistics.

Name of the activity: Determination of σ Scores and standard scores.

Suggested CRITERION point if any:

Date of Activity: 20th March 2023

Place of Activity: Statistics lab

Name of Guest Speaker/s or Judge/s or Chief Guest/s if any: N.A.

Title of the Activity: Determination of σ Scores and standard scores.

Number of Participants: 08

Name of the Teacher: Gauri Sinekar

Names of other Committee Members / Staff: N.A.

OUTCOME of the Activity with respect to mission vision of the institute and or academics:

The data of 400 pupils and mean, standard deviation were given to the students. Students read and understood the question, revised the topic of σ Scores and standard scores and found out the result. Students gain the knowledge about how to analysed the data by detemining σ Scores and standard scores of the data.

Activity with newspaper coverage if any: No

Activity data save in PC of: Department of Statistics

Prof. Pitambar Humane
IQAC Coordinator

CO ORDINATOR
INTERNAL QUALITY ASSURANCE CELL
DHARAMPETH, M. P. DEO MEMORIAL &
SCIENCE COLLEGE, NAGPUR

Name & Signature of Teacher In-charge

Dr. Akhilesh Peshwe
Principal

PRINCIPAL
Dharampeth M. P. Deo Memorial
Science College, Nagpur.



DHARAMPETH M. P. DEO MEMORIAL SCIENCE COLLEGE, NAGPUR
DEPARTMENT OF COMPUTER SCIENCE
ACADEMIC SESSION: 2022-2023

NOTICE

17th March 2023

All the students of **B.Sc. SEM [IV]** are hereby informed that the Department of Computer Science, Dharampeth M.P.Deo Memorial Science College, Nagpur is going to organize Poster Group Discussion Activity on Communication Utilities Commands and Graphical User Interfaces in Linux Unit IV [Paper II] **20th March 2023**. All the students must remain present and participate in this activity.

Venue : Computer Science Laboratory

Dr. Mrs. Snehal Narale
Head, Department of Computer Science
Head,
Department of Computer Science
Dharampeth M. P. Deo Memorial
Science College, Nagpur

Dr. Akhilesh Peshwe
Principal
Principal
Dharampeth M. P. Deo Memorial
Science College, Nagpur



DHARAMPETH M. P. DEO MEMORIAL SCIENCE COLLEGE, NAGPUR
INTERNAL QUALITY ASSURANCE CELL (IQAC)

NEP Activity Report

Date: 24th March 2023

Name of Organizing Department or Committee: Computer Science Department

Name of the activity: Group Discussion

Suggested CRITERION point if any: Criteria I, II, V

Date of Activity: 20th March 2023

Place of Activity: Computer Science Laboratory

Name of Guest Speaker/s or Judge/s or Chief Guest/s if any: Nil

Title of the Activity: Communication Utilities Commands and Graphical User Interfaces in Linux for the students of B.Sc. Sem IV [Paper II] Linux Operating System [Unit IV]

Number of Participants:

Name of the Teacher In-charge / Convener: Dr. Mrs. Snehal Narale

Names of other Committee Members / Staff: Nil

OUTCOME of the Activity with respect to mission vision of the institute and or academics:

The Objectives of Group discussion was

- Data collection
- Breeding fresh ideas and taking inputs from a particular group.
- Perception of student participants on a particular topic.
- Identify a solution to a specific problem or issue.

Group Discussion (GD) is a method of learning where students discuss issues and ideas together. In GD, students will be able to:

- Work in groups to solve problems on the topic and learn from each other.
- It helps students develop their critical thinking skills, listening and speaking skills, problem-solving abilities, and communication skills.
- Promote a deeper understanding of a topic and increase long-term retention.
- GD's can also help increase participants' attention and help maintain their focus by involving them in the learning process.
- Participants get a chance to share their experiences and defend their opinions.
- It also promotes the students to enhance their confidence level.
- It is an effective tool in problem solving, decision making and personality assessment.

Activity with newspaper coverage if any: Nil

Activity data save in PC of: Dr. Mrs. Snehal Narale's Laptop



[Handwritten signature]

[Handwritten signature]
Dr. Mrs. Snehal Narale

Name & Signature of Teacher In-charge

[Handwritten signature]
Dr. Akhilesh Peshwe
Principal

**Dharampeth M. P. Deo Memorial
Science College, Nagpur**

COORDINATOR
INTERNAL QUALITY ASSURANCE CELL
**DHARAMPETH, M. P. DEO MEMORIAL &
SCIENCE COLLEGE, NAGPUR**



DHARAMPETH M. P. DEO MEMORIAL SCIENCE COLLEGE,
North Ambazari Road, Near Ambazari Lake, Nagpur- 440033

DATA VALIDATION & VERIFICATION (DVV)

Name of the Programme : GD (Group Discussion Activity) [SEM IV]
Date of the Programme : 20/3/2023
Name of Chief Guest if any :
Name of Guest Speaker if any :

Sr. No.	Name of the Participant	Mobile Number	E-mail Id	Signature
1.	Khushbu Ganesh Nalme	8983700782	khushbuwalme14@gmail.com	[Signature]
2.	Shweta Belwat	9092460184	shweta.belwat265@gmail.com	[Signature]
3.	Ritul Bisen	9028810840	ritulbisen02@gmail.com	[Signature]
4.	Harshad N. Ajankar	9527732348	harshadajankar9@gmail.com	[Signature]
5.	Saathak Jadhav	9605710878	saathakjadhav@gmail.com	[Signature]
6.	Rahul Kawade	9359525716	kawaderahul042@gmail.com	[Signature]
7.	Ketan Bhavsar	9657957276	ketanbhavsar@gmail.com	[Signature]
8.	Jamini Mishra	8623040668	jamini.mishra@gmail.com	[Signature]
9.	Jay Anilbhau Patil	7385436956	jay.patil0326@gmail.com	[Signature]
10.	Nitin Ajay Kuskuwaha	9699423005	nitinkuskuwaha906@gmail.com	[Signature]

Signature of:
[Signature]
Programme in-charge
Head,
Department of Computer Science
Dharampeth M. P. Deo Memorial
Science College, Nagpur

[Signature]
IQAC Coordinator
CO ORDINATOR
INTERNAL QUALITY ASSURANCE CELL
DHARAMPETH, M. P. DEO MEMORIAL &
SCIENCE COLLEGE, NAGPUR

[Signature]
Principal
Dharampeth M.P. Deo Memorial
Science College, Nagpur.



DHARAMPETH M. P. DEO MEMORIAL SCIENCE COLLEGE,
North Ambazari Road, Near Ambazari Lake, Nagpur- 440033

DATA VALIDATION & VERIFICATION (DVV)

17	Adityakumar S. Shukla	9518994638	adityashukla0025@gmail.com	Shukla
12)	Anujit Mishra	8103656208	anujmishra@gmail.com	Mishra
13)	Bhagyashree Pandey	98175302601	BhagyashreePandey@gmail.com	Bhagyashree
14)	Hitesh C. Kamate	9067445755	Hitesh Kamate	Hitesh
15)	Hitesh C. Kamate	7058029112	hiteshkamate20@gmail.com	Hitesh
16)	Aditya Kumar Singh	7350543901	adityakumarSingh28890@gmail.com	A.K.S
17)	Vicky Singh	9834787931	VickySingh11052001@gmail.com	Vicky
18)	Anurag Deshpande	9763624388	anuragdeshpande@gmail.com	Anurag
19)	Penuka Lante	7919951401	penukalante28@gmail.com	Penuka
20)	Shubh Bedwal	8080440184	shubhbedwal@gmail.com	Shubh
21)	Kunal Digrao	8010294303	kunaldigrao@gmail.com	Kunal
22)	Ketan Bhat	915795276	ketanbhat53@gmail.com	Ketan
23)	Harshad N. Pawar	9527732349	Harshad Pawar	Harshad
24)	Tanishk S. Nemade	7021994767	Tanishk Nemade	Tanishk
25)	Smit V. Sankar	952240388	SmitVankar@gmail.com	Smit
26)	Santosh S. Dhanu	860510878	santoshdhanu@gmail.com	Santosh

Signature of

Proprietary In-charge
Head,

Department of Computer Science
Dharampeth M. P. Deo Memorial
Science College, Nagpur

IQAC Coordinator

COORDINATOR
INTERNAL QUALITY ASSURANCE CELL
DHARAMPETH M. P. DEO MEMORIAL &
SCIENCE COLLEGE, NAGPUR

Principal

Principal
Dharampeth M. P. Deo Memorial
Science College, Nagpur.



DHARAMPETH M. P. DEO MEMORIAL SCIENCE COLLEGE,
North Ambazari Road, Near Ambazari Lake, Nagpur-440033

DATA VALIDATION & VERIFICATION (DVV)

27]	Rahul Kawade	9359525716	Kawaderahul04@gmail.com	R Kawade
28]	Sanchita Patil	7218079074	Sanchitapatil@gmail.com	Sanchita
29]	Damini Kapse	9459277408	Damini.kapse@gmail.com	Damini
30]	Sauvraa Mikhay	9356088971	Sauvraamikhay@gmail.com	Sauvraa
31]	Devang Kohid	7888238500	devangkohid12@gmail.com	Devang
32]	Manvi Nandanwar	7709322027	manvinandanwar@gmail.com	Manvi
33]	Urnati Chopde	9021627617	urnatichopde2001@gmail.com	Urnati
34]	Avishkar Bansode	7890841788	avishkarbansode02@gmail.com	Avishkar
35]	Poojita Pawar	8356905759	poojitapawar11@gmail.com	Poojita
36]	Sahil Singh	7258868502	Sahilsingh@gmail.com	Sahil
37]	Priyankatam Patil	7090643071	priyankatam@gmail.com	Priyanka
38]	Rital Bisen	7028810860	ritalbisen06@gmail.com	Rital
39]	Yash Khedekar	7020829422	Yashkhekar5@gmail.com	Yash
40]	Ankush Chavade	7588194156	Ankushchavade56@gmail.com	Ankush
41]	Sachin m purdi	7276017322	Sachinmurdhi8@gmail.com	Sachin
42]	Ankur Khosrpati	7749884620	Khosrpati.ankur@gmail.com	Ankur

Signature of:

Programme In-charge
Head,

Department of Computer Science
Dharampeth M. P. Deo Memorial
Science College, Nagpur

IQAC Coordinator

CO ORDINATOR
INTERNAL QUALITY ASSURANCE CELL
DHARAMPETH, M. P. DEO MEMORIAL &
SCIENCE COLLEGE, NAGPUR

Principal
Principal

Dharampeth M.P. Deo Memorial
Science College, Nagpur.



DHARAMPETH M. P. DEO MEMORIAL SCIENCE COLLEGE, NAGPUR
INTERNAL QUALITY ASSURANCE CELL (IQAC)
NEP Activity Report

Date: 27/03/2023

Name of Organizing Department or Committee: Chemistry
Name of the activity: NEP Activity Report (Sem IV, paper II, Unit IV)
Suggested CRITERION point if any: Criteria II
Date of Activity: 20/03/2023
Place of Activity: Department of Chemistry
Name of Guest Speaker/s or Judge/s or Chief Guest/s if any: Nil
Title of the Activity: Magnetic properties of substances
Number of Participants: 69
Name of the Teacher In-charge / Convener: Dr. Mrs. Mrudul R. Keskar
Names of other Committee Members / Staff: Dr. Mrs. V. P. Meshram

OUTCOME of the Activity with respect to mission vision of the institute and or academics:

This is a student's centric activity. Three main types of materials are diamagnetic, paramagnetic and ferromagnetic. It helps students to know the atomic or subatomic response of a material to an applied magnetic field. In which electron spin and charge create a dipole moment and a magnetic field.



Activity with newspaper coverage if any: Nil

Activity data saved in PC of: Chemistry Department

M. Keskar
Name & Signature of Teacher In-charge
(Dr. Mrs. Mrudul R. Keskar)

Prof. Pitambar Humane
IQAC Coordinator

CO ORDINATOR
INTERNAL QUALITY ASSURANCE CELL
DHARAMPETH M. P. DEO MEMORIAL &
SCIENCE COLLEGE, NAGPUR

Dr. Akhilesh Peshwe
Principal

PRINCIPAL
Dharampeth M.P. Deo Memorial
Science College, Nagpur-440033



DHARAMPETH M. P. DEO MEMORIAL SCIENCE COLLEGE,

North Ambazari Road, Near Ambazari Lake, Nagpur-440033

DATA VALIDATION & VERIFICATION (DVV)

Name of the Programme : NEP Activity - Magnetic properties of substances (sem IV, paper-II, unit + IV)

Date of the Programme : 20-03-2023

Name of Chief Guest if any : -

Name of Guest Speaker if any : -

Sr. No.	Name of the Participant	Mobile Number	E-mail Id	Signature
1.	Shital Ketzarkar	9373389723	shitalketzarkar@gmail.com	@ketzarkar
2.	Bhumnika Thakre	7218247917	BhumnikaThakre@gmail.com	Bhumnika
3.	Apurva Venulkar	9623613917	apurva.venulkar@gmail.com	#Purva
4.	Ananya Matgare	72192189515	ananyaematgare@gmail.com	Ananya
5.	Vishakha Basulante	8329639834	VishakhaBasulante@gmail.com	Vishakha
6.	Mansi. I. Mak	8468891807	mansi19192@gmail.com	Mansi
7.	Juhi S. Chaudhari	8669248944	chaudharijuhi120@gmail.com	Juhi
8.	Samir P. Ghumde	9359236723	samerghumde002@gmail.com	Ghumde
9.	Aniket V. Kukade	7741945323	Akukade69@gmail.com	Kukade
10.	Tina. G. Rahangdale	9921776769	tinarahangdale@gmail.com	Rahangdale
11.	Vaishnavi R. Lakhe	8669894564	chhakuli.lakhe530@gmail.com	Lakhe
12.	Shyamal D. Nasre	9765943998	shyamalnare@gmail.com	Nasre
13.	Sakshi. S. Meshram	9145355783	Sakshimeshram210@gmail.com	Meshri
14.	Jagruti. D. Wankar	77447366023	Jagrutiwankar09@gmail.com	Wankar

Signature of: 
Programme In-charge

IQAC Coordinator

CO ORDINATOR

INTERNAL QUALITY ASSURANCE CELL
DHARAMPETH, M. P. DEO MEMORIAL &
SCIENCE COLLEGE, NAGPUR

Principal

PRINCIPAL

Dharampeth M.P. Deo Memorial
Science College, Nagpur-440033



DHARAMPETH M. P. DEO MEMORIAL SCIENCE COLLEGE,
North Ambazari Road, Near Ambazari Lake, Nagpur- 440033

DATA VALIDATION & VERIFICATION (DVV)

15	gauri Raut	9767873447	ankuraut2003@gmail.com	<u>Gauri</u>
16	Smruti Vaidya	8856908764	Smrutivaidya3@gmail.com	<u>Smruti</u>
17	Anushree chandel	9145631751	anuchandel2001@gmail.com	<u>Anushree</u>
18	Ayina Sheikh	8080083981	ayinashikh973@gmail.com	<u>Ayina</u>
19	Chhakuli Wadikar	9325047907	chhakuliwadikar@gmail.com	<u>Chhakuli</u>
20	Ketaki Kirpal	9912759066	KetakiKirpal12@gmail.com	<u>Ketaki</u>
21	Prachal M. Meshram	7028735508	Prachalmeshram47@gmail.com	<u>Prachal</u>
22	Yashviree P. Chavde	9769008924	yashvireechavde@gmail.com	<u>Yashviree</u>
23	Khushabu H. Chaudhase	9262074960	khushabuchaudhase@gmail.com	<u>Khushabu</u>
24	Devashri D. Bisen	7773980643	DrBisen74@gmail.com	<u>Devashri</u>
25	Sagar S. Bawane	9975460979	Sagarbawane63@gmail.com	<u>Sagar</u>
26	Chirayu B. Dolas	8010135012	chirayudolas22@gmail.com	<u>Chirayu</u>
27	Sejal R. Lakhampal	9028851568	sejallakhampal@gmail.com	<u>Sejal</u>
28	Kajal P. Nijhat	9343250629	Kajalnijhat2000@gmail.com	<u>Kajal</u>
29	Sania Midhat A. Kaya	8975706700	midhatania@gmail.com	<u>Sania</u>

Signature of:

Programme In-charge

CO ORDINATOR
INTER IQAC COORDINATOR
DHARAMPETH M. P. DEO MEMORIAL &
SCIENCE COLLEGE, NAGPUR



Principal
PRINCIPAL

Dharampeth M. P. Deo Memorial
Science College, Nagpur-440033



DHARAMPETH M. P. DEO MEMORIAL SCIENCE COLLEGE,
North Ambazari Road, Near Ambazari Lake, Nagpur-440033

DATA VALIDATION & VERIFICATION (DVV)

30	Jyoti Sharma	8669736380	jyotice8390@gmail.com	J.Sharma
31	Parshva Madavi	8830146516	parshvamadavi@gmail.com	Parshva
32	Vaishnavi Bedade	8657188093	vaishnavibedade100@gmail.com	V.Bedade
33	Aman Dongre	7709217312	amandongre2003@gmail.com	Dongre
34	Urmila V. Bondre	937673867	bondreurmila.2000@gmail.com	Bondre
35	Shravya Dhawale	8888264004	shravyadhawale124@gmail.com	Dhawale
36	Vaishavi Shende	8080640782	vaishavishende97@gmail.com	Shende
37	Siddhant Hirkan	9579092931	hirkan.siddhant@gmail.com	Hirkan
38	Kalpna Subhagpure	9579236712	kalpanasubhagpure78@gmail.com	Kalpna
39	Rupesh Bhokre	8805887370	Rupeshbhokre.123@gmail.com	Bhokre
40	Niket Thakore	7378899087	Nikethakore.123@gmail.com	Thakore
41	Ritik M. Vannar	9386740734	ritik11929@gmail.com	R.Vannar
42	Rutik V. Gajbhaye	7670826960	rutikgajbhaye05@gmail.com	Gajbhaye
43	Shashank Pandey	9998644684	pandeyshashank92@gmail.com	Pandey
44	Issaq Patil	9370720325	issaqpatil93@gmail.com	Patil
50	Praveen S. Bhojari	8010434634	Praveenb738@gmail.com	Bhojari
51	Aditya Dalkar	9028015776	dalkaraditya07@gmail.com	Dalkar
52	Harsh Kadam	9604677672	harshkadam09@gmail.com	Kadam
53	Vaishnavi Gadgil	9022976449	gadgilvaishnavi@gmail.com	Gadgil
54	Ankita Mishra	8421293176	ankitamishra445@gmail.com	Mishra
55	Smriti Chauran	738105732	asmritichauran25@gmail.com	Chauran

Signature of: [Signature]
Programme In-charge

COORDINATOR
DATA VALIDATION & VERIFICATION CELL
DHARAMPETH M. P. DEO MEMORIAL &
SCIENCE COLLEGE, NAGPUR

Principal
DHARAMPETH M. P. DEO MEMORIAL
SCIENCE COLLEGE, NAGPUR



DHARAMPETH M. P. DEO MEMORIAL SCIENCE COLLEGE, NAGPUR
INTERNAL QUALITY ASSURANCE CELL (IQAC)
NEP Activity Report

Date: 28/3/23

Name of Organizing Department or Committee: Department of Chemistry

Name of the activity: NEP Activity B.Sc. Home Science Sem IV Unit I

Suggested CRITERION point if any: Criteria II

Date of Activity: 20/3/2022

Place of Activity: Chemistry lab, 3rd floor

Name of Guest Speaker/s or Judge/s or Chief Guest/s if any: Nil

Title of the Activity: preparation of Urea-Formaldehyde Resin

Number of Participants: 10

Name of the Teacher In-charge / Convener: Dr. Sandip Madhukar Bhiwagade

Names of other Committee Members / Staff: Dr. Vaishali P. Meshram

OUTCOME of the Activity with respect to mission vision of the institute and or academics:

This is student centric activity. This activity helps to understand students what is mean by polymer, what is the difference between addition and condensation polymer. How the condensation polymer (Urea- formaldehyde resin) is prepared in the laboratory. What are the uses and environmental hazards of polymer.

Activity with newspaper coverage if any : Nil

Activity data save in PC of: Department of Chemistry



Dr. Sandip Bhiwagade
SB

Name & Signature of Teacher In-charge

[Handwritten Signature]

Prof. Pitambar Humane
IQAC Coordinator

CO ORDINATOR
INTERNAL QUALITY ASSURANCE CELL
DHARAMPETH, M. P. DEO MEMORIAL &
SCIENCE COLLEGE, NAGPUR

[Handwritten Signature]
Dr. Akhilesh Peshwe
Principal

PRINCIPAL
Dharampeth M.P. Deo Memorial
Science College, Nagpur-440044



DHARAMPETH M. P. DEO MEMORIAL SCIENCE COLLEGE,
North Ambazari Road, Near Ambazari Lake, Nagpur-440033

DATA VALIDATION & VERIFICATION (DVV)

Name of the Programme : Preparation of Urea formaldehyde resin
Date of the Programme : 20/3/2023
Name of Chief Guest if any : _____
Name of Guest Speaker if any : _____

Sr. No.	Name of the Participant	Mobile Number	E-mail Id	Signature
1.	Tarunee S. Korde	7841984450	korde.tarunee1330@gmail.com	
2.	Nimaya N. Kale	9866073792	nimayakale@gmail.com	
3.	Prachi N. Kararkar	8806244419	Prachilaxkar159@gmail.com	
4.	Ranali Ghangadkar	9309079627	Ranali02@gmail.com	
5.	Bhagyashree S. Ambule	9359139668	ambuleeb66@gmail.com	
6.	Sujata V. Kawre	9175451202	Sujatakawre1@gmail.com	
7.	Pragya S. Tiwari	6394098386	Pragyatiwari10052004@gmail.com	
8.	Ojasvi Wankhede	8767699751	wankhede.ojasvi@gmail.com	
9.	Aarushi Shanwai	9096507459	Aarushishanwai15@gmail.com	
10.	Pallavi B. Patil	8459277408	Patil.p573@gmail.com	

Signature of:

Programme In-charge

IQAC Coordinator

QUALITY ASSURANCE
DHARAMPETH, M. P. DEO MEMORIAL
SCIENCE COLLEGE, NAGPUR

Principal
PRINCIPAL

Dharampeth M. P. Deo Memorial
Science College, Nagpur-440033



DHARAMPETH M. P. DEO MEMORIAL SCIENCE COLLEGE, NAGPUR
INTERNAL QUALITY ASSURANCE CELL (IQAC)

NEP Activity Report

Date: 28/3/23

Name of Organizing Department or Committee: Department of Chemistry

Name of the activity: NEP Activity B.Sc. Sem VI Unit IV

Suggested CRITERION point if any: Criteria II

Date of Activity: 20/3/2022

Place of Activity: Chemistry lab. 3rd floor

Name of Guest Speaker/s or Judge/s or Chief Guest/s if any: Nil

Title of the Activity: preparation of condensation polymer

Number of Participants: 26

Name of the Teacher In-charge / Convener: Dr. Sandip Madhukar Bhiwagade

Names of other Committee Members / Staff: Dr. Vaishali P. Meshram

OUTCOME of the Activity with respect to mission vision of the institute and or academics:

This is student centric activity. This activity helps to understand students what is mean by polymer, what is the difference between addition and condensation polymer. How the condensation polymer (Phenol – formaldehyde resin) is prepared in the laboratory. What are the uses and environmental hazards of polymer.

Activity with newspaper coverage if any : Nil

Activity data save in PC of: Department of Chemistry



Dr. Sandip Bhiwagade

Name & Signature of Teacher In-charge

[Signature]

Prof. Pitambar Humane
IQAC Coordinator

CO ORDINATOR
INTERNAL QUALITY ASSURANCE CELL
DHARAMPETH, M. P. DEO MEMORIAL &
SCIENCE COLLEGE, NAGPUR

[Signature]

Dr. Akhilesh Peshwe
Principal

PRINCIPAL
Dharampeth M.P. Deo Memorial
Science College, Nagpur-440033



DHARAMPETH M. P. DEO MEMORIAL SCIENCE COLLEGE,
North Ambazari Road, Near Ambazari Lake, Nagpur- 440033

DATA VALIDATION & VERIFICATION (DVV)

Name of the Programme : Preparation of Condensation polymer
Date of the Programme : 20/3/2023
Name of Chief Guest if any : _____
Name of Guest Speaker if any : _____

Sr. No.	Name of the Participant	Mobile Number	E-mail Id	Signature
1	PRAIYA R JHA	9665852975	praiyaja687@gmail.com	
2	ANUSHKA S DAS	7058933157	ad04032001@gmail.com	
3	Akanksha R. Yeluzee	8767935524	akankshayeluzee@gmail.com	
4	Chaitali M. Buebarde	9359540394	Chaitali2020b@gmail.com	
5	Raksha D. Dhote	7498511875	raakshadhote3@gmail.com	
6	Shruti A. Kukde	9075232517	Shrutikukde13@gmail.com	
7	Pallavi Y. Bhagat	9022654940	Pallavim2208@gmail.com	
8	Priyanshi Singh	7219259020	priyanshisingh1804@gmail.com	
9	Siman. A. Singh.	7249465307	missumansingh3@gmail.com	
10	Bhumika D. chedde	8830391103	bhumikachedde@gmail.com	

Signature of:

Programme In-charge

ICAR COORDINATOR
INTERNAL QUALITY ASSURANCE CELL
DHARAMPETH M. P. DEO MEMORIAL &
SCIENCE COLLEGE, NAGPUR

Principal
PRINCIPAL
Dharampeth M. P. Deo Memorial
Science College, Nagpur- 440033



DHARAMPETH M. P. DEO MEMORIAL SCIENCE COLLEGE,
North Ambazari Road, Near Ambazari Lake, Nagpur- 440033

DATA VALIDATION & VERIFICATION (DVV)

11.	Samiksha R. Choudhary	7517090406	choudharysamiksha26@gmail.com	Sfny.
12.	Samiksha N. Kundekar	9145253758	samikshakundekar@gmail.com	Kundekar
13.	Jayali J. Lokhande	9356418804	jayalilokhande2910@gmail.com	Lokhande.
14.	Shivani S.R. Dcoivedi	8855900546	shivaniidwai.vd14@gmail.com	Shivani
15.	Rinam C Wankhede	8010866529	wankhedeirinam07@gmail.com	Wankhede
16.	Madhura H. Bhondave	8767484914	madhura.h.bhondave@gmail.com	Bhondave
17.	Ayushi O. Shukla	9373668043	ayushishukla78112002@gmail.com	Shukla
18.	Adesh K. Hatwar	7517431162	adeshhatawar2002@gmail.com	A.K. Hatwar
19.	shreyansh S. Naikwar	7447844189	shreyanshnaikwar7@gmail.com	Shreyansh
20.	Rupesh W. Wadde	8322676611	Rupeshwadde780@gmail.com	Rupesh
21.	Balraj Mangru Welda	9420396682	balrajweld4@gmail.com	Welda
22.	Tanmay Y. Choudhary	8600102341	tanmaychoudhary8600@gmail.com	Choudhary
23.	Manish Grade	9970329857	manishgrade99@gmail.com	Grade
24.	Shivam C. Suryawanshi	8087317297	shivamsurys128@gmail.com	Shivam
25.	Shivam S. Mewada	9607879702	shivamsaurya2011@gmail.com	Shivam
26.	Vishal Kumar Singh	9610187923	singhvishal9602@gmail.com	Vishal

Signature of:

Programme In-charge

ICAC Coordinator

COORDINATOR
INTERNAL QUALITY ASSURANCE CELL
DHARAMPETH M. P. DEO MEMORIAL &
SCIENCE COLLEGE, NAGPUR

Principal

PRINCIPAL

Dharampeth M.P. Deo Memorial
Science College, Nagpur-440033



DHARAMPETH M. P. DEO MEMORIAL SCIENCE COLLEGE, NAGPUR

INTERNAL QUALITY ASSURANCE CELL (IQAC)

Activity Report

Date: 21-03-2023

Name of Organizing Department or Committee: Department of Statistics.

Name of the activity: Determination of Difficulty Value of given data.

Suggested CRITERION point if any:

Date of Activity: 21st March 2023

Place of Activity: Statistics lab

Name of Guest Speaker/s or Judge/s or Chief Guest/s if any: N.A.

Title of the Activity: Determination of Difficulty Value of given data.

Number of Participants: 08

Name of the Teacher: Gauri Sinekar

Names of other Committee Members / Staff: N.A.

OUTCOME of the Activity with respect to mission vision of the institute and or academics:

The data of solving test question of different groups was given to the groups. Students read and understood the question, revised the topic of difficulty values in vital statistics and found out the result. Students gain the knowledge about how to analysed the data by determining of difficulty Value of given data.

Activity with newspaper coverage if any: No

Activity data save in PC of: Department of Statistics

Prof. Pitambar Humane
IQAC Coordinator

CO ORDINATOR
INTERNAL QUALITY ASSURANCE CELL
DHARAMPETH M. P. DEO MEMORIAL &
SCIENCE COLLEGE, NAGPUR

Name & Signature of Teacher In-charge

Dr. Akhilesh Peshwe
Principal

PRINCIPAL
Dharampeth M. P. Deo Memorial
Science College, Nagpur.



Dharampeth M.P. Deo Memorial Science College, Nagpur

Department Of Computer Science

Academic Session: 2022-2023

NOTICE

All the Students of B.Sc.Sem IV are hereby informed that the Department of Computer Science is organizing a Guest Lecture on "Process, Working of Process and its Types in Linux Operating System " on 21st March 2023 at 2.30pm. All the students attend this program positively.

Venue: Computer Science Laboratory

Date: 17/3/2023

Place: Nagpur

Dr. Mrs. Snehal Narale
Head,

Department of Computer Science
Dharampeth M. P. Deo Memorial
Science College, Nagpur

Dr. Akhilesh Peshwe

(Principal)

Principal

Dharampeth M.P. Deo Memorial
Science College, Nagpur.



**DHARAMPETH M. P. DEO MEMORIAL SCIENCE COLLEGE, NAGPUR
INTERNAL QUALITY ASSURANCE CELL (IQAC)**

NEP Activity Report

Date: 25th March 2023

Name of Organizing Department or Committee: Computer Science Department

Name of the activity: Guest Lecture

Suggested CRITERION point if any: Criteria II, V

Date of Activity: 21 /03/ 2023

Place of Activity: Computer Science Laboratory

Name of Guest Speaker/s or Judge/s or Chief Guest/s if any: Dr.Shweta Barhate,
Department of Electronics and Computer Science ,RTMNU Campus

Title of the Activity: Process, Working of Process and its Types for the students of B.Sc.
Sem IV [Paper II] Linux Operating System [Unit IV]

Number of Participants: 33

Name of the Teacher In-charge / Convener: Dr.Mrs.Snehal Narale

Names of other Committee Members / Staff: Nil

OUTCOME of the Activity with respect to mission vision of the institute and or academics:

The objective of this activity was to provide platform to the students through which they can understand the detail concept of Linux operating system process. In this lecture, guest speaker explain the concept of Processes its use and types in detail. A process in Linux is nothing but a program in execution. It's a running instance of a program. Any command that user can execute starts a process. At the end of this lecture students understood the difference between foreground and background process along with the methods.

Guest lecturers provide a vital educational experience for the students based on their real-world life experiences. Students get to see the insight and perspective of the guest lecturers' specific field. One of the benefit of the lecture was to get the students and understand the difference between what they learn in their textbooks and the experiences shared by the guest speaker. Students thereby build important connections between what they have learned and the real world.

Activity with newspaper coverage if any: Nil

Activity data save in PC of: Dr. Mrs. Snehal Narale's Laptop



Prof.Pitambar Humane
IQAC Coordinator
CO ORDINATOR

**INTERNAL QUALITY ASSURANCE CELL
DHARAMPETH, M. P. DEO MEMORIAL &**

Dr.Mrs.Snehal Narale

Name &Signature of Teacher In-charge

Dr.AkhileshPeshwe
Principal
Principal

**Dharampeth M. P. Deo Memorial
Science College, Nagpur**



DHARAMPETH M. P. DEO MEMORIAL SCIENCE COLLEGE,
North Ambazari Road, Near Ambazari Lake, Nagpur- 440033

DATA VALIDATION & VERIFICATION (DVV)

Name of the Programme : Guest Lecture on process, working of process and its types.
Date of the Programme : 21/03/2023
Name of Chief Guest if any : _____
Name of Guest Speaker if any : Dr. Shweta Borhate, Dept of Electronics & CS, RTMNU, campus

Sr. No.	Name of the Participant	Mobile Number	E-mail Id	Signature
1.	Puneeshottam Pawashare	7020693071	pawasharepuneeshottam@gmail.com	
2.	Khushbu G. Wafarik	8983700782	khushbuwafarik14@gmail.com	
3.	Yamini A. Mishra	8623090668	yaminimishra92259@gmail.com	
4.	Sakshi V. Kanade	8806934839	sakshikanade32@gmail.com	
5.	Isha S. Nemade	7028494761	ishanemade39@gmail.com	
6.	Arijal V. Rangankar	8880031259	arijalrangankar@gmail.com	
7.	Harik C. Mishra	9067445755	Harikc@gmail.com	
8.	Unkumar D. Devnayan	9963624388	unmaj12@gmail.com	
9.	Abhay P. Khandare	7350956307	abhaykhandare33@gmail.com	
10.	Kunal S. Digrate	8010276303	kunal.digrate@gmail.com	

Signature of:

Programme In-charge

IQAC Coordinator
CO ORDINATOR
INTERNAL QUALITY ASSURANCE CELL
DHARAMPETH M. P. DEO MEMORIAL &
SCIENCE COLLEGE, NAGPUR

Principal
Principal
Dharampeth M. P. Deo Memorial
Science College, Nagpur



DHARAMPETH M. P. DEO MEMORIAL SCIENCE COLLEGE,
North Ambazari Road, Near Ambazari Lake, Nagpur- 440033

DATA VALIDATION & VERIFICATION (DVV)

11) SAHIL SINGH	7258868502	sahilsingh08@gmail.com	<i>[Signature]</i>
12) Sumit Sable	9322410388	sumitsable0510@gmail.com	<i>[Signature]</i>
13) VAISHALI TADHAV	9156916355	v70806393@gmail.com	<i>[Signature]</i>
14) BHAGYARATHI PANDEY	8175302601	pandeybhagya@gmail.com	<i>[Signature]</i>
15) Hitesh V. Kumbhar	7058427112	hiteshkumbhar@gmail.com	<i>[Signature]</i>
16) Sumen. R. Singh	9922018536	sumensingh4245@gmail.com	<i>[Signature]</i>
17) Vikky. A. Singh	9834782931	vicky.singh1303@gmail.com	<i>[Signature]</i>
18) Yash. R. Khedekar	7020929422	yash.khedekar@gmail.com	<i>[Signature]</i>
19) Ankush Gawade	8090004076	agawade560@gmail.com	<i>[Signature]</i>
20) Saurav Wiley	9256088871	sauravwiley@gmail.com	<i>[Signature]</i>
21) Aditya Kulkarni Singh	7350543301	adityasingh28180@gmail.com	<i>[Signature]</i>
22) Jay Anilbhai Patil	7385436956	jay.patil0326@gmail.com	<i>[Signature]</i>
23) Anuj H. Mishra	8103656208	anujmishra2512@gmail.com	<i>[Signature]</i>
24) Urvashi S. Umrathe	8177937293	umratheumrathe@gmail.com	<i>[Signature]</i>
25) Ritul K. Bisen	7028810810	ritulbisen_06@gmail.com	<i>[Signature]</i>
26) Mani. Nandanwar	7709972027	maninandanwar@gmail.com	<i>[Signature]</i>

Signature of:

[Signature]

Programme in-charge

IQAC Coordinator

CO ORDINATOR

INTERNAL QUALITY ASSURANCE CELL
DHARAMPETH M. P. DEO MEMORIAL & SCIENCE COLLEGE, NAGPUR

Principal

Dharampeth M. P. Deo Memorial
Science College, Nagpur



DHARAMPETH M. P. DEO MEMORIAL SCIENCE COLLEGE, NAGPUR
INTERNAL QUALITY ASSURANCE CELL (IQAC)

Activity Report (NEP)

Date: 22.3.23

Name of Organizing Department or Committee: Home Science Department

Name of the activity: Enlisting the issues of all the stages of Development.

Suggested CRITERION point if any:

Date of Activity: 22.3.23

Place of Activity: Classroom

Name of Guest Speaker/s or Judge/s or Chief Guest/s if any:

Title of the Activity: Preparing charts

Number of Participants: Semester 6. (13 participants)

Name of the Teacher In-charge / Convener: Mrs M M Deshpande

Names of other Committee Members / Staff:

OUTCOME of the Activity with respect to mission vision of the institute and or academics:

To understand age related concerns & issues to help to identify & seek intervention if needed. To not let the concerns & issues be an obstacle in the course of changes.

Activity with newspaper coverage if any:

Activity data save in PC of: Mrs M M Deshpande

Note: Kindly share geotag photographs separately along with report on igacdsc2022@gmail.com

Prof. Pitambar Humane
COORDINATOR
INTERNAL QUALITY ASSURANCE CELL
DHARAMPETH, M. P. DEO MEMORIAL &
SCIENCE COLLEGE, NAGPUR

Name & Signature of Teacher In-charge

Dr. Akhilesh Peshwe
PRINCIPAL
Dharampeth M. P. Deo Memorial
Science College, Nagpur-440033



DHARAMPETH M. P. DEO MEMORIAL SCIENCE COLLEGE,
North Ambazari Road, Near Ambazari Lake, Nagpur- 440033

DATA VALIDATION & VERIFICATION (DVV)

Name of the Programme

Evolutionary Concerns Issues (NGP)

Date of the Programme

22-3-23

Name of Chief Guest if any

Name of Guest Speaker if any

Sr. No.	Name of the Participant	Mobile Number	E-mail Id	Signature
1.	Sushmita Mallick	9887916560	sushmita200@gmail.com	Sushmita
2.	Mayuri - G. Mali	7498065023	Mayurimali2002@gmail.com	Mayuri
3.	Mahima Wankhede	1821883251	mahimawankhede@gmail.com	Mahima
4.	Ananya A Meghree	9284834439	ananyameghree@gmail.com	Ananya
5.	Renuka Raut	8855972285	rautrenuka3@gmail.com	Renuka
6.	Riya Sherekar	7249070278	sherekar04riya@gmail.com	Riya
7.	Vanshika Talase	7447275658	vanshika.talase@gmail.com	Vanshika
8.	Vaishnavi Bahadure	9284679244	vaishnavibahadure@gmail.com	VBahadure
9.	Vaishnavi Upasak	9975287431	upasakvaishnavi@gmail.com	VUpasak
10.	Pooja Chute	9552381386	laxmichute123@gmail.com	Pooja

Signature of:

Programme In-charge

COORDINATOR
INTERNAL QUALITY ASSURANCE CELL
DHARAMPETH, M. P. DEO MEMORIAL &
SCIENCE COLLEGE, NAGPUR

PRINCIPAL
Dharampeth M. P. Deo Memorial
Science College, Nagpur-440033



DHARAMPETH M. P. DEO MEMORIAL SCIENCE COLLEGE, NAGPUR
INTERNAL QUALITY ASSURANCE CELL (IQAC)
Activity Report (Nep)

Date: 22.3.23

Name of Organizing Department or Committee: Home Science Department.

Name of the activity: Adult Nutritional Plate

Suggested CRITERION point if any: II.

Date of Activity: 22.3.23

Place of Activity: Department Home Science

Name of Guest Speaker/s or Judge/s or Chief Guest/s if any:

Title of the Activity: Pictorial Presentation of Adult Nutrition (Plate)

Number of Participants: 13

Name of the Teacher In-charge / Convener: Mrs M M Deshpande

Names of other Committee Members / Staff:

OUTCOME of the Activity with respect to mission vision of the institute and or academics:

Conceptualize the importance of Nutritional care in Elderly.

Activity with newspaper coverage if any: NA

Activity data save in PC of: Home Science Department Desktop

Prof. Pitambar Humane
IQAC Coordinator

CO-ORDINATOR
INTERNAL QUALITY ASSURANCE CELL
DHARAMPETH M. P. DEO MEMORIAL SCIENCE COLLEGE

Name & Signature of Teacher In-charge
Head, Department of Home Science
Dharampeth M.P. Deo Memorial
Science College, Nagpur

Dr. Akhlesh Peshwe
PRINCIPAL
DHARAMPETH M.P. DEO
MEMORIAL SCIENCE COLLEGE
NAGPUR



DHARAMPETH M. P. DEO MEMORIAL SCIENCE COLLEGE,
North Ambazari Road, Near Ambazari Lake, Nagpur-440033

DATA VALIDATION & VERIFICATION (DVV)

Name of the Programme : Pictorial Presentation of Adult Nutrition (Plate)
Date of the Programme : 22.3.23
Name of Chief Guest if any : _____
Name of Guest Speaker if any : _____

Sr. No.	Name of the Participant	Mobile Number	E-mail Id	Signature
1.	Sushmita Mallick	9337916560	sushmitt1760@gmail.com	
2.	Mayuri Mali	7498065023	Mayurimali1810@gmail.com	
3.	Mahinsa Wankhede	7821883251	mahinsawankhede7@gmail.com	
4.	Ananya A Meghre	9284834639	anangameghre2@gmail.com	
5.	Renuka Raut	8855972285	xautrenuka85@gmail.com	
6.	Riya Sherekar	7249070278	sherekarriya@gmail.com	
7.	Vanshika Todase	7447275658	vanshikatodase@gmail.com	
8.	Vaishnavi Bahadure	9284679244	vaishnavibahadure@gmail.com	
9.	Vaishnavi Upasak	9975287481	vaishnaviupasakvaishnavi@gmail.com	
10.	Pooja Chute	9552381386	laxmichute123@gmail.com	

Signature of:

Head, Department of Home Science
Dharampeth M. P. Deo Memorial
Science College, Nagpur

COORDINATOR
ICAC Coordinator
INTERNAL QUALITY ASSURANCE CELL
DHARAMPETH, M. P. DEO MEMORIAL &
SCIENCE COLLEGE, NAGPUR

PRINCIPAL
Dharampeth M.P. Deo Memorial
Science College, Nagpur-440033



Activity Report

Date: 23/03/2023

Name of Organizing Department or Committee: Microbiology Department

Name of the activity: NEP Activity

Suggested CRITERION point if any: Criterion IV & II

Date of Activity: 24/03/2023

Place of Activity: Microbiology Laboratory

Name of Guest Speaker/s or Judge/s or Chief Guest/s if any: Guest Speaker- Nil

Title of the Activity : Charts on Life Cycle on *E. histolytica* Report making on Spirulina production

Number of Participants: 22

Name of the Teacher In-charge / Convener: Dr. Vaishali Pimple

Names of other Committee Members / Staff:

OUTCOME of the Activity with respect to mission vision of the institute and or academics: 1. Students worked in groups to make charts which enabled teamwork.

2. Students understood the lifecycle of *E. histolytica* and Spirulina Production.



Pimple
Dr. Vaishali Pimple

Name & Signature of Teacher In-charge

Prof. Pitambar Humane
IQAC Coordinator

Dr. Akhilesh Peshwe
Principal

Principal
Dharampeth M. P. Deo Memorial
Science College, Nagpur



DATA VALIDATION & VERIFICATION (DVV)

Name of the Programme : Chart on Life Cycle of E-Histolytica / Report on Spirulina Production
 Date of the Programme : 23/03/2023
 Name of Chief Guest if any : -
 Name of Guest Speaker if any : -

Sr. No.	Name of the Participant	Mobile Number	E-mail Id	Signature
1	Riya A. Singh	9595649931	riyaas2007@gmail.com	
2	Shreya A. Jha	8983236002	Sangeetajha0303@gmail.com	
3	Anjali Meshram	7767905772	anjali.meshram2003@gmail.com	
4	Sonali G. Choudhary	9856055003	sonalichoudhary19@gmail.com	
5	Gravsi R. Bhojare	9668335876	gravisrbhojare34@gmail.com	
6	Aakansha Y. Maital	8010923662	aakanshamaital@gmail.com	
7	Bally K. Wanjari	9326013213	kaiskhanwanjari12345@gmail.com	
8	Shruti Channekar	9699823892	shrutichannekar2706@gmail.com	

Signature of:

Programme In-charge

IQAC Coordinator

CO-ORDINATOR
INTERNAL QUALITY ASSURANCE CELL
DHARAMPETH, M. P. DEO MEMORIAL S.C.

Principal



DATA VALIDATION & VERIFICATION (DVV)

9	Chanchal K. Waghware	7796016894	waghwarechanchal@gmail.com	chanchal
10	Meenal A. Chaudhary	9529014604	meenaldchaudhary2004@gmail.com	meenal
11	Krutika S. Pokale	9021533041	pokalekrutika2004@gmail.com	krutika
12	Komalika S. Chaudhari	9322033866	komalikachaudhari073@gmail.com	kspokale
13	Vaishnavi N. Tonge	8421657945	Vaishnavitonge2004@gmail.com	Vaish
14	Anjali Thakre	7066554821	thakreanjali521@gmail.com	Anjali
15	Apiksha S. Ketangale	7559455794	apiksha.ketangale26@gmail.com	Apiksha
16	Ravindra M. Khadse	8007198273	khadseravindra892@gmail.com	Ravindra
17	Aparna Mohare	7020649887	aparnamohare23@gmail.com	Aparna
18	Arya Phoke	8080851619	aryanamisuta1331@gmail.com	Arya
19	Peyanghu Raut	9322725233	peyanghuraute56@gmail.com	Peyanghu
20	Aishwarya Pardey	8605291390	aishwarya8605291390@gmail.com	Aishwarya
21	Yogita R. Denge	7058437240	yogitadenge@gmail.com	Yogita
22	Nishi B. Rai	7058638984	nrishi1419@gmail.com	Nishi

Signature of:

[Signature]

Programme in-charge

[Signature]

CO-ORDINATOR
IQAC Coordinator

Principal

Principal

Dharampeth M. P. Deo Memorial
Science College, Nagpur



DHARAMPETH M. P. DEO MEMORIAL SCIENCE COLLEGE,
NAGPUR
INTERNAL QUALITY ASSURANCE CELL (IQAC)
Activity Report

Date: 24/03/2023

Name of Organizing Department or Committee: Microbiology Department

Name of the activity: NEP Activity

Suggested CRITERION point if any: Criterion II & V

Date of Activity: 23/03/2023

Place of Activity: Microbiology Laboratory

Name of Guest Speaker/s or Judge/s or Chief Guest/s if any: Guest Speaker- Nil

Title of the Activity: Making of Charts on Mechanism of Nitrogen Fixation based on BSc

Semester IV syllabus

Number of Participants: 47

Name of the Teacher In-charge / Convener: Dr. Vaishali Pimple

Names of other Committee Members / Staff: Nil

OUTCOME of the Activity with respect to mission vision of the institute and or academics:

1. Students understood the Mechanism of Symbiotic Nitrogen Fixation diagrammatically they worked in groups to make the charts which promoted spirit of team work amongst students.
2. Students explained the charts, which built there confidence and subject understanding.
3. Students understood the nature of symbiotic nitrogen fixing bacteria along with the process of root nodule formation in leguminous plants along with the role of *nif* gene.



BSc Semester IV (Microbiology) students demonstrating their charts on "Mechanism of Nitrogen fixation" along with teacher in-charge Dr. Vaishali Pimple

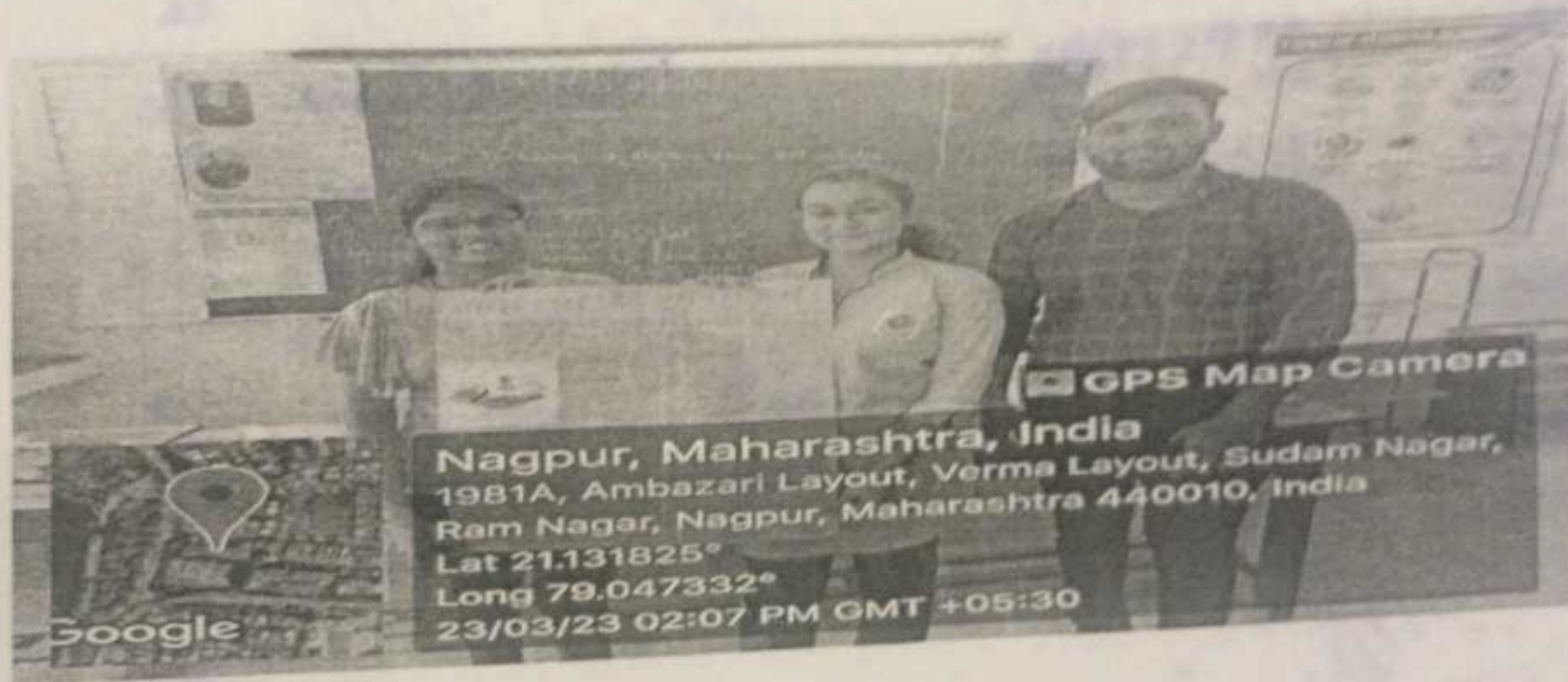

Name & Signature of Teacher In-charge: Dr. Vaishali Pimple
Assistant Professor (CHB)

(Pimple)

Signature of HOD: *Kathoke*
Dr. V. R. Kathoke
Head
Deptt. of Microbiology
Charampath M. P. Des Memorial
Science College, Nagpur

Prof. Pitambar Humane
IQAC Coordinator

INTERNAL QUALITY ASSURANCE CELL
DHARAMPATH, M. P. DES MEMORIAL &
SCIENCE COLLEGE, NAGPUR

(Peshwe)
Dr. Akhilesh Peshwe
Principal

Principal
DHARAMPATH M. P. DES MEMORIAL
SCIENCE COLLEGE, NAGPUR



DHARAMPETH M. P. DEO MEMORIAL SCIENCE COLLEGE,
North Ambazari Road, Near Ambazari Lake, Nagpur- 440033

DATA VALIDATION & VERIFICATION (DVV)

Name of the Programme : Chart on Mechanism of N₂ - Fixation (SSC SEM IV)
Date of the Programme : 23/9/2023
Name of Chief Guest if any : _____
Name of Guest Speaker if any : _____

Sr. No.	Name of the Participant	Mobile Number	E-mail Id	Signature
1.	Sakshi .S. Meshuam	9145355733	Sakshimshuam210@gmail.com	
2.	Jagouti D. Workar	7447366023	jagoutiwarkar93@gmail.com	
3.	Juhi S. Chaudhari	8669248944	chaudharijuhi120@gmail.com	
4.	Mansi .I. Male	8668891807	mansi19192@gmail.com	
5.	Urmila Bhandar	9890693867	bhandarurmila2000@gmail.com	
6.	Shravya S. Dhawale	8888264004	Shravyadhawale.124@gmail.com	
7.	Vaibhavi Shende	8080640782	Vaibhavishende.97@gmail.com	
8.	Sagar S. Bawane	9975460979	Sagarbawane637@gmail.com	
9.	Nikita .S. Bhave	7820812749	nikitabhawe.98@gmail.com	
10.	Chirayu B. Dolat	8010135012	chirayudolat22@gmail.com	

Signature of:

Programme In-charge

IQAC Coordinator

COORDINATOR
INTERNAL QUALITY ASSURANCE CELL
DHARAMPETH, M. P. DEO MEMORIAL &
SCIENCE COLLEGE, NAGPUR

Principal



DHARAMPETH M. P. DEO MEMORIAL SCIENCE COLLEGE,
North Ambazari Road, Near Ambazari Lake, Nagpur- 440033

DATA VALIDATION & VERIFICATION (DVV)

Name of the Programme : Chart on N₂ fixation / Report on Bioaccumulation & Biomagnification
Date of the Programme : _____
Name of Chief Guest If any : _____
Name of Guest Speaker If any : _____

Sr. No.	Name of the Participant	Mobile Number	E-mail Id	Signature
1.	Anushree chandel	9145631751	anuchand1200@gmail.com	Achandel
2.	Smriti Vaidya	9145751345	smritivaidya@gmail.com	Smriti
3.	Ketaki Kishor	9110759066	ketakikishor13@gmail.com	Ketaki
4.	Vaishnavi Gadge	9022976449	gadgavaishnavi00@gmail.com	Vgadga
5.	Gangai Hodge	7972076671	gangaihodge@gmail.com	Gangai
6.	Poojwal S. Bhojane	8010434634	Poojwal6738@gmail.com	Poojwal
7.	Harsh. S. Kodape	9604677672	harshkodape005@gmail.com	Harsh
8.	Vedant V. Bask	8530455796	vedantbask2005@gmail.com	Vedant
9.	Ayush Bhojane	8805887370	bhojaneayush@gmail.com	Ayush
10.	Niket Bhojane	7378898057	Niketbhojane@gmail.com	Niket

Signature of:

Programme In-charge

IQAC Coordinator

Principal

Dharampeth M. P. Deo
Memorial Science College
Nagpur



DHARAMPETH M. P. DEO MEMORIAL SCIENCE COLLEGE,
North Ambazari Road, Near Ambazari Lake, Nagpur- 440033

NEP Activity
Sem II

DATA VALIDATION & VERIFICATION (DVV)

11	Tejas Rewad	9796027056	Tejasrewad@gmail.com	Tejas
12)	Tina Bahangdale	9921776769	tinabahangdale@gmail.com	Tina Bahangdale
13)	Vaishnavi Lakhe	8669694864	chhakudi.lakhe63@gmail.com	Chhakudi Lakhe
14)	Chhakuli Wadikar	9325447907	chhakuliwadikar@gmail.com	Chhakuli Wadikar
15)	Pooja Itankar	9156973252	poojaitanekar@gmail.com	Pooja Itankar
16)	Shymal Nawase	9765943998	shymalnawase@gmail.com	Shymal Nawase
17)	Kalyani Shahare	9307046378	Shahare.Kalyani5@gmail.com	Kalyani Shahare
18)	Pratiksha Navghare	8623033760	Pratikshinavghare@gmail.com	Pratiksha Navghare
19)	Shital G. Bankar	7758055139	Shitalbankar122@gmail.com	Shital Bankar
20)	Vaibhav Malewar	8767838219	vaibhavmalewar22@gmail.com	Vaibhav Malewar
21)	Sureth Langadge	9390516517	surethlangadge11@gmail.com	Sureth Langadge
22)	Vaishnavi Kapse	8983151089	vaishnavikapse05@gmail.com	Vaishnavi Kapse
23)	Mansi Raut	7395114931	Mansiraut431@gmail.com	Mansi Raut
24)	Twinkal Lokhande	8149176609	twinkallokhande14@gmail.com	Twinkal Lokhande
25)	Rohit Ashok Pawate	9573897285	pawatewhit8@gmail.com	Rohit Pawate
26)	Siddhant Hirkane	9923141982	siddhant_hirkane@gmail.com	Siddhant Hirkane
27)	Kalpna Sahagpure			Kalpna Sahagpure

Signature of:

Programme In-charge

IQAC Coordinator

INTERNAL QUALITY ASSURANCE CELL
DHARAMPETH M. P. DEO MEMORIAL SCIENCE COLLEGE, NAGPUR

Principal

Dharampeth M. P. Deo Memorial Science College, Nagpur



DHARAMPETH M. P. DEO MEMORIAL SCIENCE COLLEGE, NAGPUR
INTERNAL QUALITY ASSURANCE CELL (IQAC)

Activity Report

Date : 28/3/23

Name of Organizing Department or Committee: Department of Chemistry

Name of the activity: NEP Activity Home Science Sem. III Unit 3

Suggested CRITERION point if any: Criteria II

Date of Activity: 23/3/23

Place of Activity: Home Science Department 2nd floor

Name of Guest Speaker/s or Judge/s or Chief Guest/s if any: Nil

Title of the Activity: Group discussion on saturated and unsaturated hydrocarbon

Number of Participants: 8

Name of the Teacher In-charge / Convener: Dr. Sandip Madhukar Bhiwagade

Names of other Committee Members / Staff: Dr. V. Meshram

OUTCOME of the Activity with respect to mission vision of the institute and or academics:

This is student centric activity. This activity helps to understand students very clearly to understand between the difference the saturated and unsaturated hydrocarbon.

Activity with newspaper coverage if any : Nil

Activity data save in PC of: Department of Chemistry



Prof. Pitambar Humane
IQAC Coordinator

CO ORDINATOR
INTERNAL QUALITY ASSURANCE CELL
DHARAMPETH, M. P. DEO MEMORIAL &
SCIENCE COLLEGE, NAGPUR

Name & Signature of Teacher In-charge

Dr. Akhilesh Peshwe
Principal

PRINCIPAL
Dharampeth M.P. Deo Memorial
Science College, Nagpur-440032



DHARAMPETH M. P. DEO MEMORIAL SCIENCE COLLEGE,
North Ambazari Road, Near Ambazari Lake, Nagpur- 440033

DATA VALIDATION & VERIFICATION (DVV)

Name of the Programme : Group discussion on saturated & unsaturated hydrocarbons
Date of the Programme : 23/03/23
Name of Chief Guest if any : _____
Name of Guest Speaker if any : _____

Sr. No.	Name of the Participant	Mobile Number	E-mail Id	Signature
1	Bhavana Gusudosani	8888437303	bhavanagusudosani@gmail.com	
2	Minad. L. patle	9158070732	patleminad83@gmail.com	
3	Shalu T. Pawdhi	8329115380	shalypawdhi3@gmail.com	
4	Neha R. Vishwakarma	8983534173	nehavishwakarma28@gmail.com	
5	Neha L. Suresant	9067167848	nehasuresant@gmail.com	
6	SAKSHI R. CHAKUNDE	7843018801	sakshichakunde@gmail.com	
7	Ashwini N. Pandey	8308621072	ashwinipandey229@gmail.com	
8	Aditi R. Vaidya	9075714591	aditivaidya619@gmail.com	

Signature of:

Programme In-charge

IQAC Coordinator

INTERNAL QUALITY ASSURANCE CELL,
DHARAMPETH, M. P. DEO MEMORIAL &
SCIENCE COLLEGE, NAGPUR

Principal

PRINCIPAL

Dharampeth M.P. Deo Memorial
Science College, Nagpur



DHARAMPETH M. P. DEO MEMORIAL SCIENCE COLLEGE, NAGPUR
INTERNAL QUALITY ASSURANCE CELL (IQAC)

Activity Report

Date: 23.3.23

Name of Organizing Department or Committee: Home Science Department

Name of the activity: Discussion

Suggested CRITERION point if any: I & II

Date of Activity: 23.3.23

Place of Activity: Classroom

Name of Guest Speaker/s or Judge/s or Chief Guest/s if any:

Title of the Activity: Factor affecting Life Style in adulthood

Number of Participants: Semester 4 (13 Participants)

Name of the Teacher In-charge / Convener: Mrs M M Deshpande

Names of other Committee Members / Staff:

OUTCOME of the Activity with respect to mission vision of the institute and or academics:

To develop the concept. Understand the transition to adulthood is important & that adults, decisions, preferences & efforts can be detrimental .

Activity with newspaper coverage if any:

Activity data save in PC of: Mrs M M Deshpande.

Note: Kindly share geotag photographs separately along with report on igacdsc2022@gmail.com

Prof. Pitambar Humane
IQAC Coordinator
CO ORDINATOR
INTERNAL QUALITY ASSURANCE CELL
DHARAMPETH, M. P. DEO MEMORIAL &
SCIENCE COLLEGE, NAGPUR

Name & Signature of Teacher In-charge

Dr. Akhilesh Peshwe
PRINCIPAL
Dharampeth M.P. Deo Memorial
Science College, Nagpur-440033



DHARAMPETH M. P. DEO MEMORIAL SCIENCE COLLEGE,
North Ambazari Road, Near Ambazari Lake, Nagpur-440033

DATA VALIDATION & VERIFICATION (DVV)

Name of the Programme : Concept of Life Style in adulthood
Date of the Programme : 23.3.23
Name of Chief Guest if any : _____
Name of Guest Speaker if any : _____

Sr. No.	Name of the Participant	Mobile Number	E-mail Id	Signature
1.	Puagya S. Thurani	6394098386	Puagyaticari1206@gmail.com	
2.	Ojaswi M. Wankhede	8767699751	Ojaswiwankhede@gmail.com	
3.	Avani Shumai	9096507659	Avanishumai15@gmail.com	
4.	Tannu Konde	7841984450	KondeTannu139@gmail.com	
5.	Kimaya Kale	8866073792	Kimayakale003@gmail.com	
6.	Shrushti Palekar	7387067403	Shrushtipalekar@gmail.com	
7.	Vaishnavi Pradhan	9763169560	Pradhanvaishnavi15@gmail.com	
8.	Prachi N. Laxkar	9806244419	prachilaxkar159@gmail.com	
9.	Archita Mashe	9975034151	madhooarchita@gmail.com	
10.	Kerina T. Dixit	9280237708	clivokcrin20@gmail.com	

Signature of:

Programme In-charge

IQAC COORDINATOR
INTERNAL QUALITY ASSURANCE CELL
DHARAMPETH M. P. DEO MEMORIAL SCIENCE COLLEGE
NAGPUR

PRINCIPAL
Dharampeth M. P. Deo Memorial
Science College, Nagpur-440033



DHARAMPETH M. P. DEO MEMORIAL SCIENCE COLLEGE, NAGPUR

INTERNAL QUALITY ASSURANCE CELL (IQAC)

Activity Report

Date: 23/03/2023

Name of Organizing Department or Committee: Department of Microbiology

Name of the activity: Word puzzle on DNA replication.

Suggested CRITERION point if any: II and V

Date of Activity: 23/03/2023

Place of Activity: Department of Microbiology Dharampeth MP Deo Memorial Science College, Nagpur

Name of Guest Speaker/s or Judge/s or Chief Guest/s if any: Nil

Title of the Activity: Word puzzle on DNA replication on Paper I- unit II for semester IV students.

Number of Participants: 49

Name of the Teacher In-charge / Convener: Dr. Pratiksha V. Pohekar

Names of other Committee Members / Staff:

OUTCOME of the Activity with respect to mission vision of the institute and or academics:

- This syllabus based word puzzle are designed to promote, a fun way to study and in the process help improve students' knowledge.
- This puzzle competitions enables students to think from different angles or simply 'to think out of the box'.
- Students can do critical thinking, and get into a habit of innovative learning.
- This competition help students identify what they know and what they don't know



Name & Signature of Teacher In-charge

Dr. Pratiksha V. Pohekar

Prof. Pitambar Humane

CO ORDINATOR
IQAC Coordinator
INTERNAL QUALITY ASSURANCE CELL
DHARAMPETH, M. P. DEO MEMORIAL &
SCIENCE COLLEGE, NAGPUR

HOD

Dr. V. R. Kathoke
Head
Deptt. of Microbiology
Dharampeth MP Deo Memorial
Science College, Nagpur

Dr. Akhilesh Peshwe

Principal
Principal
Dharampeth M. P. Deo Memorial
Science College Nagpur



DHARAMPETH M. P. DEO MEMORIAL SCIENCE COLLEGE,
North Ambazari Road, Near Ambazari Lake, Nagpur- 440033

DATA VALIDATION & VERIFICATION (DVV)

Name of the Programme : Word Puzzle on DNA replication
Date of the Programme : 23/03/23 6pm IV
Name of Chief Guest if any : _____
Name of Guest Speaker if any : _____

Sr. No.	Name of the Participant	Mobile Number	E-mail Id	Signature
	Gargi Hadge	7972076671	gargihadge@gmail.com	
	Vaishnavi Gadge	9022976449	gadgevaishnavi00@gmail.com	
	Vedant Baxy	8530455796	vedantbaxy2003@gmail.com	
	Prajwal Bhoyar	8010434634	prajwalb738@gmail.com	
	Harsh Kodape	9604677672	harshkodape008@gmail.com	
	Jyoti Sharma	8669736380	jyotis8390@gmail.com	
	Sania Raza	8975726700	widdhatsania@gmail.com	
	Siddharth Hirkane	9574092931	hirkanesiddharth@gmail.com	
	Sagar S. Bawane	9975460979	sagarbawane637@gmail.com	
	Shubham C. Bisen	7448289544	Shubhamc1bisen@gmail.com	

Signature of:

Programme In-charge

IQAC Coordinator
INTERNAL QUALITY ASSURANCE CELL
DHARAMPETH M. P. DEO MEMORIAL
SCIENCE COLLEGE, NAGPUR

Principal
Dharampeth M. P. Deo Memorial
Science College, Nagpur



DHARAMPETH M. P. DEO MEMORIAL SCIENCE COLLEGE,
North Ambazari Road, Near Ambazari Lake, Nagpur- 440033

DATA VALIDATION & VERIFICATION (DVV)

Uamila V. Bondre	9340673867	bondreamila.2000@gmail.com	Uamila
Shravya Dhasale	8888264004	shravyadhasale.12@gmail.com	Shravya
Vibhavi Shende	8086640782	Vibhavishende.97@gmail.com	VShende
Vaishnavi Lakhe	8669594864	chakuli.lakhe.36@gmail.com	Ualakhe
Kalpana D. Suhagpuro	9579936712	kalpana.suhagpuro@gmail.com	Ksuhagpuro
Vaishnavi T. Kapse	8983151089	Vaishnavikapse05@gmail.com	Vaishnavi
Shital G. Bankar	7758055139	shitalbankar122@gmail.com	S.G.Bankar
Pooja S. Itankar	9156973252	poojitankar987@gmail.com	P
Twinkal G. Lokhande	8149176609	twinkal.lokhande@gmail.com	Twinkal
Kalyani C. Shahare	9307046378	Shaharekalyani.5@gmail.com	Kal
Suruti S. Lonergadge	8390516517	surutilonergadge@gmail.com	Suruti
Pratiksha S. Naughare	8623033760	NaugharePratiksha44@gmail.com	P.S.Naughare
Vishakha Badwanale	83296139834	VishakhaBadwanale@gmail.com	VBadwanale

Signature of:

Programme In-charge

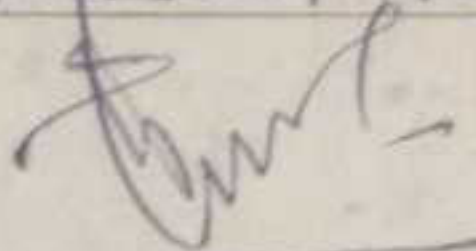
IQAC Coordinator

CO ORDINATOR
INTERNAL QUALITY ASSURANCE CELL
DHARAMPETH M. P. DEO MEMORIAL S.
SCIENCE COLLEGE, NAGPUR

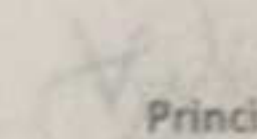
Principal

Principal
Dharampeth M. P. Deo Memorial Science College, Nagpur



DHARAMPETH M. P. DEO MEMORIAL SCIENCE COLLEGE,
North Ambazari Road, Near Ambazari Lake, Nagpur- 440033

DATA VALIDATION & VERIFICATION (DVV)

Rohit A. Pawate	9373097285	pawate.rohit8@gmail.com	Rohate
Jagruti D. Warkar	7447366023	jagrutiwarkar09@gmail.com	Juk
Sakshi S. Meshram	9145355733	sakshimeshram240@gmail.com	Sakshi
Samir P. Ghumde	9359236713	samirghumde2002@gmail.com	Ghumde
Juhi S. Chaudhari	8659248944	chaudharijuhi12@gmail.com	Juhi
Mansi I. Mate	8468891807	mansi19182@gmail.com	Mate
AMAN. A. DONARE	7709217312	amandongre2003@gmail.com	Donare
Vaishnavi Bedade	8830107397	vaishnavibedade100@gmail.com	Bedade
Darshana S. Madavi	8830146516	darshnamadavi@gmail.com	Madavi
Chirayu B. Dolas	8010135012	chirayudolas22@gmail.com	Dolas
Vaibhav A. Malwan	8767838219	vaibhavamalwan99@gmail.com	Malwan
Nikita S. Bhave	7820812749	nikitabhav98@gmail.com	Bhave
Aanchal S. Singh	7875537925	Sankesh Singh 23923@gmail.com	Aanchal Singh
Niket Thakre	7378895087	niketthakre82-11	Thakre
Anjali Mishra	9325604513	anjalinimishra-11	Mishra
Vaishnavi Nandpure	9834184621	Vaishnavinand36a	Nandpure

Signature of:

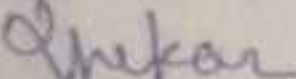
Programme In-charge

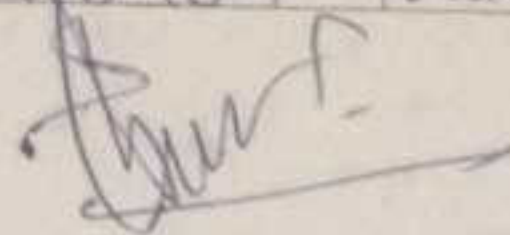
IQAC Coordinator

Principal

Principal
Dharampeth M. P. Deo Memorial
Science College, Nagpur



DHARAMPETH M. P. DEO MEMORIAL SCIENCE COLLEGE, NAGPUR
INTERNAL QUALITY ASSURANCE CELL (IQAC)

Activity Report

Date: 31/03/2023

Name of Organizing Department or Committee: Computer Science

Name of the activity: NEP Activity

Suggested CRITERION point if any: V

Date of Activity: 24/03/2023

Place of Activity: College Premises (Class Rooms)

Name of Guest Speaker/s or Judge/s or Chief Guest/s if any: NA

Title of the Activity: Writing Syntax of all components of Class in C++

Number of Participants: 45

Name of the Teacher In-charge / Convener: Mrs. Ruma Kapre

Names of other Committee Members / Staff: NA

OUTCOME of the Activity with respect to mission vision of the institute and or academics:

The activity was based on syllabus topics. Students first practiced the syntax of how to create the class in C++, all the components of class like data members, data function etc. through the activity they learned to write syntax of the class which is base of the C++ languages.

Activity with newspaper coverage if any: NA

Activity data save in PC of: Mrs. Ruma Kapre



Mrs. Ruma R. Kapre
Name & Signature of Teacher In-charge

Prof. Pitambar Humane
IQAC Coordinator

CO ORDINATOR
INTERNAL QUALITY ASSURANCE CELL
DHARAMPETH, M. P. DEO MEMORIAL &
SCIENCE COLLEGE, NAGPUR

Dr. Abhilesh Peshwe
Principal

PRINCIPAL
Dharampeth M.P. Deo Memorial
Science College, Nagpur-440034



DHARAMPETH M. P. DEO MEMORIAL SCIENCE COLLEGE,
North Ambazari Road, Near Ambazari Lake, Nagpur- 440033

DATA VALIDATION & VERIFICATION (DVV)

Name of the Programme : Writing Syntax of class in C++ [SEM-II, Unit I, NEP Activity]
Date of the Programme : 24/03/2023
Name of Chief Guest if any : NA
Name of Guest Speaker if any : NA

Sr. No.	Name of the Participant	Mobile Number	E-mail Id	Signature
1	Mohit Khudekar	8055328357	mohitkhudekar@gmail.com	Mohit Khudekar
2	Dhyanani V. Zagade	9022866318	dhyananizagade@gmail.com	Dhyanani
3	Pranali V. Gupta	7020069377	29991537@gmail.com	Pranali
4	Muskan C. Veichya	9309779287	muskanveichya9@gmail.com	Muskan
5	Janvi V. Khode	4585066634	JanviKhode592@gmail.com	Janvi
6	Aman S. Kaur	9028837552	kaur787@gmail.com	Aman
7	Tushar Achare	9075935617	achare.tushar5@gmail.com	Tushar
8	Vedant B. Umethkar	9049932753	umethkarvedant@gmail.com	Vedant
9	Genella B. Machade	9112142728	nikhilmachade2005@gmail.com	Genella
10	Nikhil S. Kale	952943941	nikhilkale09@gmail.com	Nikhil

Signature of

Programme In-charge

[Mrs. RUMA KAPRE]

CO-ORDINATOR
INTERNAL QUALITY ASSURANCE CELL
DHARAMPETH, M. P. DEO MEMORIAL &
SCIENCE COLLEGE, NAGPUR

Principal
PRINCIPAL
Dharampeth M. P. Deo Memorial
Science College, Nagpur-440033



DHARAMPETH M. P. DEO MEMORIAL SCIENCE COLLEGE,
North Ambazari Road, Near Ambazari Lake, Nagpur- 440033

DATA VALIDATION & VERIFICATION (DVV)

11	Pratik Misra	8324788243	Pratik Misra @gmail.com Pratik
12	Pratish Gularia	9579343851	Pratishgularia79@gmail.com Pr
13	Rutika Yadav	8446085943	yadavrutika434@gmail.com Rutika
14	Sakshi Mishra	9529889315	Sakshimishra39683@gmail.com Sakshi
15	Simran Arimale	7666330683	simrandhimala80@gmail.com Arimale
16	Varsha Turkar	9373650950	varshaturkar488@gmail.com Turkar
17	Priyanshu Singh	9527710380	Priyanshusinghji0012@gmail.com P Singh
18	Vibhanshu Tane	9561232204	Vibhanshutane7@gmail.com Vibhanshu
19	Janhvi Jage	7385060171	JanhviJage08@gmail.com Janhvi
20	Janhvi Lalber	8466510539	Janvilalber@gmail.com Janhvi
21	Tejas Dongre	9322578918	Tj98744@gmail.com Tejas
22	Kaushik K. Bisen	7837880117	Kaushik@gmail.com Kaushik
23	Bhagyashali D. Neware	7796434177	Sakshineware2011@gmail.com B D Neware
24	Aagushi V. Singh	9595119942	aa8hussingh6591@gmail.com Singh
25	Ishita N. Deshpande	9130091540	ishitandeshpande21004@gmail.com Ishita
26	Veena Borikar	9302016921	veenaborikar14@gmail.com Veena

Signature of

Programme In charge

Mrs. Ruma Kapre

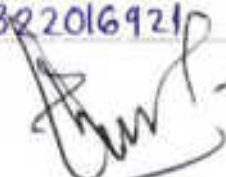
CO ORDINATOR
INTERNAL QUALITY ASSURANCE CELL
DHARAMPETH, M. P. DEO MEMORIAL &
SCIENCE COLLEGE, NAGPUR

PRINCIPAL
Dharampeth M. P. Deo Memorial
Science College, Nagpur-440033



DHARAMPETH M. P. DEO MEMORIAL SCIENCE COLLEGE,
North Ambazari Road, Near Ambazari Lake, Nagpur- 440033

DATA VALIDATION & VERIFICATION (DVV)

27	Jagruhi Fullawar	8767911307	ajagruhi@rediffmail.com	JH
28	Sonia Nivaf	7055425021	nivafsonia1970@gmail.com	SNivaf
29	Nisha Kosarekar	9830996845	nishakosarekar93@gmail.com	NKosarekar
30	Samiksha Panchbudhe	9763075890	Samikshapanbudhe36@gmail.com	S.Panchbudhe
31	Beditiksha Boreve	9579836818	Beditikshaboreve49@gmail.com	Boreve
32	Dewashri Karkole	9021344205	KarkoleDewashri@gmail.com	D.P.Karkole
33	Samiksha Shenkar	7420881158	Samikshashenkar08@gmail.com	S.Shenkar
34	Divyani Zade	7972403069	divyanizade2005@gmail.com	Zade
35	Vaidehi Nagolkar	9325963446	vaidehinagolkar07@gmail.com	Vaidehi
36	Badal G. Somkuwar	7448247750	badalsomkuwar1@gmail.com	Badal
37	Rahul B. Pandey	8767788703	RP9356521@gmail.com	R.Pandey
38	Monu. P. Pat.	7350950579	monupat@gmail.com	Pat.
39	Vidya Lohi	7020963219	Vidyalohi8@gmail.com	V.Lohi
40	Ritik H. Hiranwar	7438066424	RitikHiranwar37@gmail.com	Hiranwar
41	Pratik D. Chalkh	9021640532	PratikChalkh07@gmail.com	P.D.Chalkh
42	Ved. S. Choudhary	7498572766	vedchoudhary.05.749@gmail.com	Ved

Signature of

Programme in-charge

Mrs. Ruma Kapre

IQAC Coordinator
CO ORDINATOR
INTERNAL QUALITY ASSURANCE CELL
DHARAMPETH, M. P. DEO MEMORIAL &
SCIENCE COLLEGE, NAGPUR

Principal
PRINCIPAL

Dharampeth M.P. Deo Memorial
Science College, Nagpur-440033



DHARAMPETH M. P. DEO MEMORIAL SCIENCE COLLEGE, NAGPUR
INTERNAL QUALITY ASSURANCE CELL (IQAC)

Activity Report

Date: 31/03/2023

Name of Organizing Department or Committee: Computer Science

Name of the activity: NEP Activity

Suggested CRITERION point if any: V

Date of Activity: 24/03/2023

Place of Activity: Computer Science Laboratory

Name of Guest Speaker/s or Judge/s or Chief Guest/s if any: NA

Title of the Activity: Learn and Draw Block Diagram of Compiler

Number of Participants: 31

Name of the Teacher In-charge / Convener: Mrs. Ruma Kapre

Names of other Committee Members / Staff: NA

OUTCOME of the Activity with respect to mission vision of the institute and or academics:

To participate in the activity students, need to first practice to draw block diagram of compiler. They first learn, read practiced the block diagram of compiler which was helpful as per exam point of view. The activity make compulsory for the student to study the architecture of compiler and also drawing of block diagram of compiler.

Activity with newspaper coverage if any: NA

Activity data save in PC of: Mrs. Ruma Kapre



Prof. Pitambar Humane
IQAC Coordinator

Mrs. Ruma Kapre
Name & Signature of Teacher In-charge

Dr. Akhilesh Peshwe
Principal

CO ORDINATOR
INTERNAL QUALITY ASSURANCE CELL
DHARAMPETH, M. P. DEO MEMORIAL &
SCIENCE COLLEGE, NAGPUR

PRINCIPAL
Dharampeth M.P. Deo Memorial
Science College, Nagpur-440033



DHARAMPETH M. P. DEO MEMORIAL SCIENCE COLLEGE,
North Ambazari Road, Near Ambazari Lake, Nagpur- 440033

DATA VALIDATION & VERIFICATION (DVV)

Name of the Programme : Drawing block diagram of compiler
Date of the Programme : 24/03/2023 SEM-VI [UNIT: I NEP ACTIVITY]
Name of Chief Guest if any : _____
Name of Guest Speaker if any : _____

Sr. No.	Name of the Participant	Mobile Number	E-mail Id	Signature
1	Soni A Raj	9855999509	sonia.ramail7@gmail.com	
2	Komal M Kumbhakar	7620314869	kombhakar.komal94@gmail.com	
3	Neha J. Bankar	8055477553	neha2002bankar@gmail.com	
4	Samiksha Kulkarni	9307133863	samikshakulkarni@gmail.com	
5	Midha Rajkumar	8668974021	midherajkumar@gmail.com	
6	Tanu S. Mohule	7057844982	tanumohule41@gmail.com	
7	Ritu. L. Choudhary	8180962189	ritulalit.choudhary@gmail.com	
8	Tarun P. Patil	9422488044	tarunpatil2001@gmail.com	
9	Sanchit Joshi	8975706788	sanchit.joshi.02@gmail.com	
10	Seema Lakda	7058728070	seemalakda073@gmail.com	

Signature of:

Programme In-charge

[Mrs. Ruma Kapre]

IQAC Coordinator

CO ORDINATOR
INTERNAL QUALITY ASSURANCE CELL
DHARAMPETH, M. P. DEO MEMORIAL &
SCIENCE COLLEGE, NAGPUR

Principal

PRINCIPAL
Dharampeth M. P. Deo Memorial
Science College, Nagpur-440033



DHARAMPETH M. P. DEO MEMORIAL SCIENCE COLLEGE,
North Ambazari Road, Near Ambazari Lake, Nagpur- 440033

DATA VALIDATION & VERIFICATION (DVV)

11.	Miss. Pranjal D. Sawalkar,	7385458510	pranjal.sawalkar1234@gmail.com	@sawalkar
12.	Diya R. Patil	7757052463	diyapatil553@gmail.com	@patil
13.	Samiksha R. Khasare	9604473539	sakshasgre@gmail.com	@khasare
14.	Pratisha Chaudhari	7507317699	pratishachaudhari2002@gmail.com	pratikha
15.	Khusli J. Gupta	9922997235	kg098920@gmail.com	@gupta
16.	Dikshita Sehane	9028830801	dikshitasahane	Dikshita
17.	Sahil P. Jivtada	9573414643	sahiljivtada23@gmail.com	Sahil
18.	Pranav S. Dore	8055292863	pranav9@gmail.com	Pranav
19.	Nikhil Jankar	8530960607	Nikhiljankar9-leon	Nikhil
20.	Pranav Mahajan	7385551492	Pranavmahajan@22	Pranav
21.	Mukund Flood	9604485872	MUKUNDHAWAR2002@gmail.com	Mukund
22.	Rajat Rahad	9175635273	RajatRahad13@gmail.com	Rajat
23.	Mahesh P. Maske	2021951177	maheshmaske48@gmail.com	Maske
24.	Aashi Singh	770908740	aashi434@gmail.com	Aashi
25.	Prakhar M. Sonar	7558464862	Sonarprakhar13@gmail.com	Prakhar
26.	Tanmay S. Gadam	7262099396	tanmaygadams1@gmail.com	T.S.Gadam

Signature of

Programme In-charge

[Mrs. Ruma Kapre]

IQAC Coordinator

CO ORDINATOR
INTERNAL QUALITY ASSURANCE CELL
DHARAMPETH, M. P. DEO MEMORIAL &
SCIENCE COLLEGE, NAGPUR

Principal
PRINCIPAL

Dharampeth M.P. Deo Memorial
Science College, Nagpur-440033



DHARAMPETH M. P. DEO MEMORIAL SCIENCE COLLEGE, NAGPUR
INTERNAL QUALITY ASSURANCE CELL (IQAC)

Activity Report

Date: 24.3.23

Name of Organizing Department or Committee: Home Science Department.

Name of the activity: Enlist Community Resources for well being seen in your community

Suggested CRITERION point if any: I & II.

Date of Activity: 24.3.23

Place of Activity: Discussion in the Classroom

Name of Guest Speaker/s or Judge/s or Chief Guest/s if any:

Title of the Activity: Preparing list of community resources of well being.

Number of Participants: 13

Name of the Teacher In-charge / Convener: Mrs M M Deshpande

Names of other Committee Members / Staff:

OUTCOME of the Activity with respect to mission vision of the institute and or academics:

To conceptualize the importance of understanding the policy maker role in generating & making available the resources for human well being.

To make student realize that they too can contribute towards well being.

Activity with newspaper coverage if any:

Activity data save in PC of:

Note: Kindly share geotag photographs separately along with report on igacdsc2022@gmail.com

Prof. Pitambar Humane
COORDINATOR
INTERNAL QUALITY ASSURANCE CELL
DHARAMPETH, M. P. DEO MEMORIAL &
SCIENCE COLLEGE, NAGPUR

Name & Signature of Teacher In-charge

Dr. Akhilesh Peshwe
PRINCIPAL
Dharampeth M.P. Deo Memorial
Science College, Nagpur-440033



DHARAMPETH M. P. DEO MEMORIAL SCIENCE COLLEGE,
North Ambazari Road, Near Ambazari Lake, Nagpur-440033

DATA VALIDATION & VERIFICATION (DVV)

Name of the Programme : Discussion on Community Resources
'Enlist Community Resources of well-being'
Date of the Programme : 29.3.23
Name of Chief Guest if any : _____
Name of Guest Speaker if any : _____

Sr. No.	Name of the Participant	Mobile Number	E-mail Id	Signature
1.	Sushmita Mallick	9337916560	sushmmmt760@gmail.com	
2.	Mayurvi Mali	7498065023	Mayurvimali182005@gmail.com	
3.	Mahima Wankhede	7821883251	Mahimawankhede7@gmail.com	
4.	Ananya A. Meshre	9284834439	ananyaameshre@gmail.com	
5.	Renuka Raut	8855972285	rautrrenuka85@gmail.com	
6.	Riya Sherkar	7249070278	sherkaroriya@gmail.com	
7.	Vanshika Todare	7449275658	vanshikatodare@gmail.com	
8.	Vaishnavi Bahadure	9284679244	vaishnavibahadure94@gmail.com	
9.	Vaishnavi Upasak	9975287431	upasakvaishnavi@gmail.com	
10.	Pooja Chulte	9552881886	loxmicchulte1226@gmail.com	

Signature of:

Programme In-charge

COORDINATOR
INTERNAL QUALITY ASSURANCE CELL
DHARAMPETH, M. P. DEO MEMORIAL &
SCIENCE COLLEGE, NAGPUR

Principal
PRINCIPAL
Dharampeth M.P. Deo Memorial
Science College, Nagpur-440033



DHARAMPETH M. P. DEO MEMORIAL SCIENCE COLLEGE, NAGPUR
INTERNAL QUALITY ASSURANCE CELL (IQAC)

Activity Report (NEP)

Date: 24.3.23

Name of Organizing Department or Committee: Home Science Department

Name of the activity: Pictorial Representation/chart after discussion in the class

Suggested CRITERION point if any: I & II

Date of Activity: 24.3.23

Place of Activity: In the class

Name of Guest Speaker/s or Judge/s or Chief Guest/s if any: NA

Title of the Activity: Roles in Adult Life

Number of Participants: 15

Name of the Teacher In-charge / Convener: Mrs Manju Deshpande

Names of other Committee Members / Staff:

OUTCOME of the Activity with respect to mission vision of the institute and or academics:

As the study is adulthood psychology it is easy to remember & understand the varied Roles
in adult life covering the entire adulthood years

Activity with newspaper coverage if any:

Activity data save in PC of:

Note: Kindly share geotag photographs separately along with report on igacdsc2022@gmail.com

Prof. Pitambar Humane
IQAC Coordinator

CO ORDINATOR
INTERNAL QUALITY ASSURANCE CELL
DHARAMPETH, M. P. DEO MEMORIAL &
SCIENCE COLLEGE, NAGPUR

Name & Signature of Teacher In-charge

Dr. Akhilesh Peshwe
PRINCIPAL

Dharampeth M. P. Deo Memorial
Science College, Nagpur-440033



DHARAMPETH M. P. DEO MEMORIAL SCIENCE COLLEGE,
North Ambazari Road, Near Ambazari Lake, Nagpur-440033

DATA VALIDATION & VERIFICATION (DVV)

Name of the Programme : Pictorial representation on Adult Roles. (NEP)
Date of the Programme : 24-3-23
Name of Chief Guest if any : _____
Name of Guest Speaker if any : _____

Sr. No.	Name of the Participant	Mobile Number	E-mail id	Signature
1	Pragya Tiwari	6394098286	Pragyatiwari@gmail.com	
2	Ojasvi Wankhede	8767699751	Ojasviwankhede@gmail.com	
3	Avani Shekhar	2096507459	Avanishkharani15@gmail.com	
4	Tanav Konde	7841984450	kondetanav13@gmail.com	
5	Kinaya Kale	8866073992	Kinayakale03@gmail.com	
6	Shrushti Patkar	7387067403	ShrushtiPatkar@gmail.com	
7	Vaishnavi Pradhan	9763169560	Pradhanvaishnavi15@gmail.com	
8	Pooja Laxkar	890626449	poojalaxkar15@gmail.com	
9	Archita Maske	9975034151	maskearchita@gmail.com	
10	Korina T. Dixer	9286237798	korinatdixer2009@gmail.com	

Signature of:

Programme In-charge

QAC Coordinator
INTERNAL QUALITY ASSURANCE CELL
DHARAMPETH, M. P. DEO MEMORIAL &
SCIENCE COLLEGE, NAGPUR

PRINCIPAL
Dharampeth M. P. Deo Memorial
Science College, Nagpur-440033



DHARAMPETH M. P. DEO MEMORIAL SCIENCE COLLEGE, NAGPUR

INTERNAL QUALITY ASSURANCE CELL (IQAC)

Activity Report

Date: 25th March 2023

Name of Organizing Department or Committee : Electronics Department

Name of the Activity : To study 7493 IC using datasheet.

Suggested CRITERION point if any : Suggested criteria II

Date of Activity : 25th March 2023

Place of Activity : Electronics Lab

Name of Guest Speaker/s or Judge/s or Chief Guest/s if any : Not applicable

Title of the Activity: To study 7493 IC using datasheet.

Based on Unit : 3(Paper II)

Class : Semester II

Number of Participants : 16

Name of the Teacher In-charge / Convener: Mrs. Leena P. Thakare

OUTCOME of the Activity with respect to mission vision of the institute and or academics:

Students studied pin diagram, features and applications of 7493 IC.

Prof. Pimleshwar Humane
COORDINATOR
INTERNAL QUALITY ASSURANCE CELL
IQAC Coordinator
DHARAMPETH, M. P. DEO MEMORIAL &
SCIENCE COLLEGE, NAGPUR

Prof. Varsha V. Rangari
Dr. Varsha V. Rangari
Professor & Head
Head of the Department
Department of Electronics
Dharampeth M. P. Deo Memorial
Science College, Nagpur

Dr. Akhilesh Peshwe
Principal
Dharampeth M. P. Deo Memorial
Science College, Nagpur.



DHARAMPETH M. P. DEO MEMORIAL SCIENCE COLLEGE, NAGPUR
Department of Electronics
Semester II- (2022-23)
Activity (Paper II- Unit- 3)

Sr. No.	Student Name	Mobile Number	Email ID
1	Tanu Ajay Singh	8806355808	tanusingh63492@gmail.com
2	Monali Narendraji Shende	7796516257	shendemonali92@gmail.com
3	Vaidhavi Baburao Gongal	7507907278	gayatrigongal787@gmail.com
4	Aayushi Vikram Singh	9595119942	senxerox04@gmail.com
5	Kashish Kamalkumar Bisen	7887886117	kashishbisen05@gmail.com
6	Tannu Arun Varthi	9322044903	tannuvarthi@gmail.com
7	Abhishek Ravindra Singh	8208948107	abhi0882005@gmail.com
8	Vedant Onkar Umretkar	9049932753	umretkarvedant@gmail.com
9	Sandeep Rakesh Kumar Kumar	8081144948	sandeepk27900@gmail.com
10	Khushi Rajiv Pali	8767607224	palikhushi4@gmail.com
11	Tejas Rajesh Chelmeelwar	9604662119	tejaschelmeelwar@gmail.com
12	Isha Ishwar Waghmare	8855919474	ishawaghmare9474@gmail.com
13	Simran Narendra Dhimole	8390347026	mishralaxmi210@gmail.com
14	Harshata Gunderao Warkhede	9860432428	bandukeshao20@gmail.com
15	Bhagyashali Dadarao Neware	7796434177	sakshineware2017@gmail.com
16	Khushbu Rajiv Pali	8459565214	palikhushbu59@gmail.com

Name & Signature of Teacher In-Charge

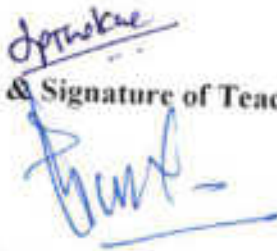

Prof. Pitambar Humane
IQAC Coordinator

CO ORDINATOR
INTERNAL QUALITY ASSURANCE CELL
DHARAMPETH, M. P. DEO MEMORIAL &
SCIENCE COLLEGE, NAGPUR

Name & Signature of Head of the Department

Dr. Varsha V. Rangari
Professor & Head
Department of Electronics
Dharampeth M.P. Deo Memorial
Science College, Nagpur

Dr. Akhilesh Peshwe
Principal

Principal
Dharampeth M.P. Deo Memorial
Science College, Nagpur.

DM5490/DM7490A, DM7493A Decade and Binary Counters

General Description

Each of these monolithic counters contains four master-slave flip-flops and additional gating to provide a divide-by-two counter and a three-stage binary counter for which the count cycle length is divide-by-five for the 90A and divide-by-eight for the 93A.

All of these counters have a gated zero reset and the 90A also has gated set-to-nine inputs for use in BCD nine's complement applications.

To set their maximum count length (decade or four-bit binary), the \bar{B} input is connected to the Q_A output. The input count pulses are applied to input A and the outputs are as

described in the appropriate truth table. A symmetrical divide-by-ten count can be obtained from the 90A counters by connecting the Q_D output to the A input and applying the input count to the B input which gives a divide-by-ten square wave at output Q_A .

Features

- Typical power dissipation
 - 90A 145 mW
 - 93A 130 mW
- Count frequency 42 MHz

Connection Diagrams

Dual-In-Line Package

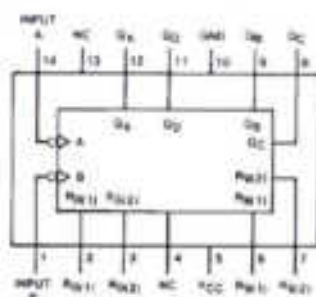

TL7490J-1

Order Number DM5490J, DM5490W or DM7490AN
See NS Package Number J14A, N14A or W14B

Dual-In-Line Package

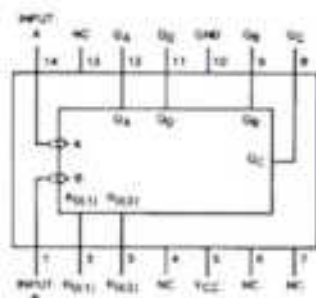

TL7493A-2

Order Number DM7493AN
See NS Package Number N14A

'90A Switching Characteristics

at $V_{CC} = 5V$ and $T_A = 25^\circ C$ (See Section 1 for Test Waveforms and Output Load)

Symbol	Parameter	From (Input) To (Output)	$R_L = 400\Omega$ $C_L = 15\text{ pF}$		Units
			Min	Max	
f_{MAX}	Maximum Clock Frequency	A to Q_A B to Q_B	32 15		MHz
t_{PLH}	Propagation Delay Time Low to High Level Output	A to Q_A		16	ns
t_{PHL}	Propagation Delay Time High to Low Level Output	A to Q_A		18	ns
t_{PLH}	Propagation Delay Time Low to High Level Output	A to Q_C		48	ns
t_{PHL}	Propagation Delay Time High to Low Level Output	A to Q_C		50	ns
t_{PLH}	Propagation Delay Time Low to High Level Output	B to Q_B		15	ns
t_{PHL}	Propagation Delay Time High to Low Level Output	B to Q_B		21	ns
t_{PLH}	Propagation Delay Time Low to High Level Output	B to Q_C		32	ns
t_{PHL}	Propagation Delay Time High to Low Level Output	B to Q_C		35	ns
t_{PLH}	Propagation Delay Time Low to High Level Output	B to Q_D		32	ns
t_{PHL}	Propagation Delay Time High to Low Level Output	B to Q_D		35	ns
t_{PLH}	Propagation Delay Time Low to High Level Output	SET-9 to Q_A, Q_C		30	ns
t_{PHL}	Propagation Delay Time High to Low Level Output	SET-9 to Q_B, Q_C		40	ns
t_{PHL}	Propagation Delay Time High to Low Level Output	SET-0 Any Q		40	ns

'93A Switching Characteristics

at $V_{CC} = 5V$ and $T_A = 25^\circ C$ (See Section 1 for Test Waveforms and Output Load)

Symbol	Parameter	From (Input) To (Output)	$R_L = 400\Omega$ $C_L = 15 pF$		Units
			Min	Max	
f_{MAX}	Maximum Clock Frequency	A to Q_A	32		MHz
		B to Q_B	15		
t_{PLH}	Propagation Delay Time Low to High Level Output	A to Q_A		16	ns
t_{PLL}	Propagation Delay Time High to Low Level Output	A to Q_A		16	ns
t_{PLH}	Propagation Delay Time Low to High Level Output	A to Q_D		20	ns
t_{PLL}	Propagation Delay Time High to Low Level Output	A to Q_D		20	ns
t_{PLH}	Propagation Delay Time Low to High Level Output	B to Q_B		16	ns
t_{PLL}	Propagation Delay Time High to Low Level Output	B to Q_B		21	ns
t_{PLH}	Propagation Delay Time Low to High Level Output	B to Q_C		32	ns
t_{PLL}	Propagation Delay Time High to Low Level Output	B to Q_C		35	ns
t_{PLH}	Propagation Delay Time Low to High Level Output	B to Q_D		51	ns
t_{PLL}	Propagation Delay Time High to Low Level Output	B to Q_D		51	ns
t_{PLQ}	Propagation Delay Time High to Low Level Output	SET-Q to Any Q		40	ns

Logic Diagrams

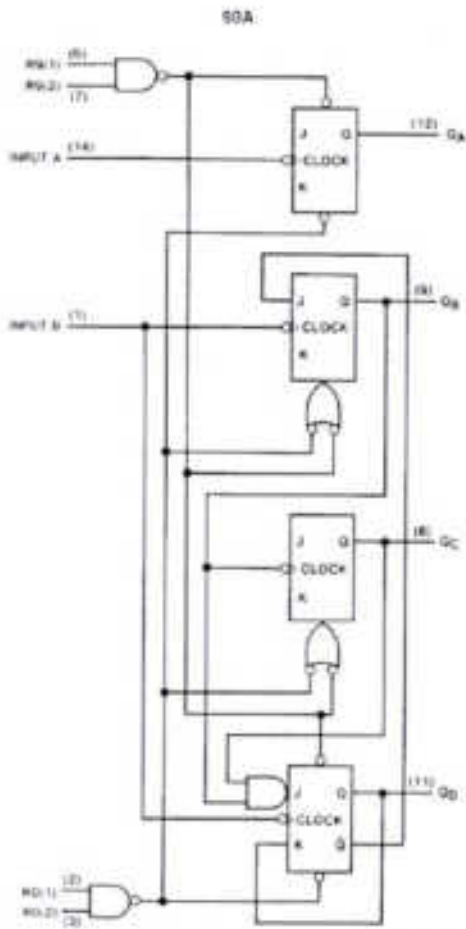

TLH-8523-2

The J and K inputs shown without connectors are for reference only and are functionally at a high level.

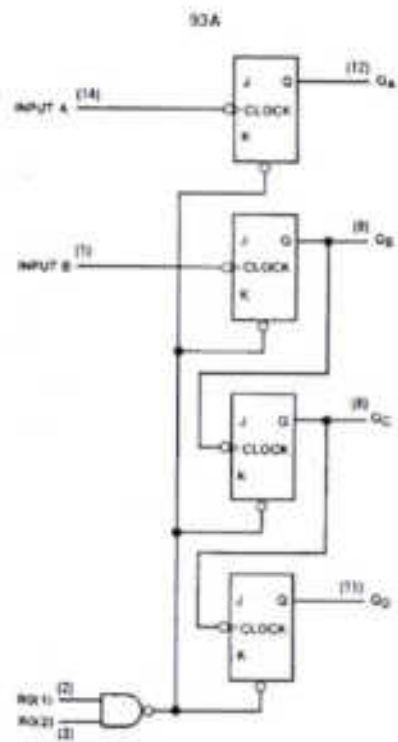

TLH-8523-4

Physical Dimensions inches (millimeters)

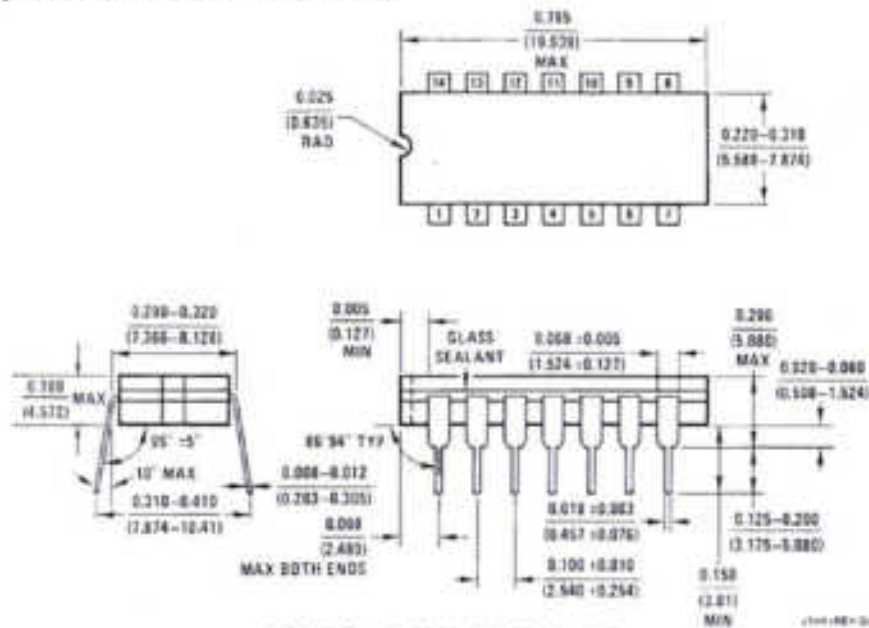

14-Lead Ceramic Dual-In-Line Package (J)
Order Number DM5490J
NS Package Number J14A

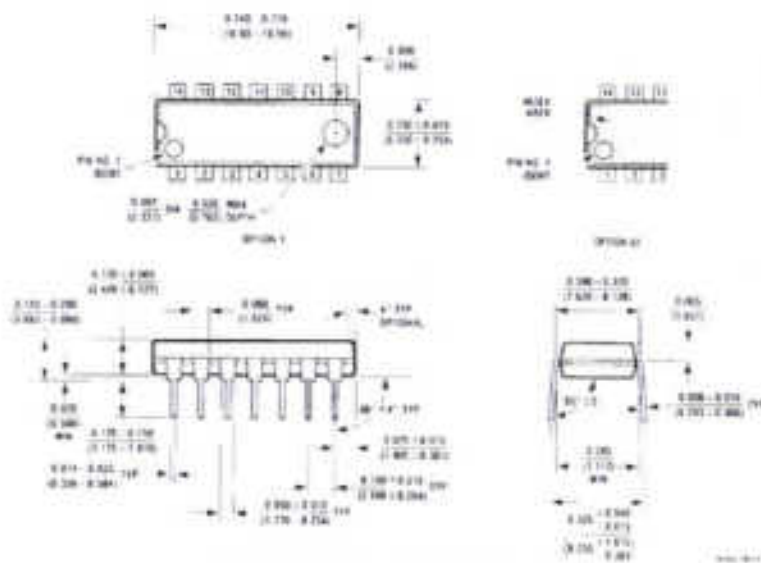

14-Lead Molded Dual-In-Line Package (N)
Order Number DM7490AN or DM7493AN
NS Package Number N14A

Function Tables (Note D)

93A
BCD Count Sequence
(See Note A)

Count	Outputs			
	Q _D	Q _C	Q _B	Q _A
0	L	L	L	L
1	L	L	L	H
2	L	L	H	L
3	L	L	H	H
4	L	H	L	L
5	L	H	L	H
6	L	H	H	L
7	L	H	H	H
8	H	L	L	L
9	H	L	L	H

93A
BCD Bi-Quinary (5-2)
(See Note B)

Count	Outputs			
	Q _A	Q _D	Q _C	Q _B
0	L	L	L	L
1	L	L	L	H
2	L	L	H	L
3	L	L	H	H
4	L	H	L	L
5	H	L	L	L
6	H	L	L	H
7	H	L	H	L
8	H	L	H	H
9	H	H	L	L

93A
Count Sequence
(See Note C)

Count	Outputs			
	Q _D	Q _C	Q _B	Q _A
0	L	L	L	L
1	L	L	L	H
2	L	L	H	L
3	L	L	H	H
4	L	H	L	L
5	L	H	L	H
6	L	H	H	L
7	L	H	H	H
8	H	L	L	L
9	H	L	L	H
10	H	L	H	L
11	H	L	H	H
12	H	H	L	L
13	H	H	L	H
14	H	H	H	L
15	H	H	H	H

93A
Reset/Count Function Table

Reset Inputs				Outputs			
R0(1)	R0(2)	R9(1)	R9(2)	Q _D	Q _C	Q _B	Q _A
H	H	L	X	L	L	L	L
H	H	X	L	L	L	L	L
X	X	H	H	H	L	L	H
X	L	X	L				COUNT
L	X	L	X				COUNT
L	X	X	L				COUNT
X	L	L	X				COUNT

93A
Reset/Count Function Table

Reset Inputs		Outputs			
R0(1)	R0(2)	Q _D	Q _C	Q _B	Q _A
H	H	L	L	L	L
L	X				COUNT
X	L				COUNT

Note A: Output Q_B is connected to input B for BCD count.

Note B: Output Q_C is connected to input A for bi-Quinary count.

Note C: Output Q_A is connected to input D.

Note D: H = High Level, L = Low Level, X = Don't Care.

Recommended Operating Conditions

Symbol	Parameter		DM7493A			Units
			Min	Nom	Max	
V_{CC}	Supply Voltage		4.75	5	5.25	V
V_{IH}	High Level Input Voltage		2			V
V_{IL}	Low Level Input Voltage				0.8	V
I_{OH}	High Level Output Current				-0.8	mA
I_{OL}	Low Level Output Current				16	mA
f_{CLK}	Clock Frequency (Note 5)	A	0		32	MHz
		B	0		16	
t_w	Pulse Width (Note 5)	A	15			ns
		B	30			
		Reset	15			
t_{RR}	Reset Release Time (Note 5)		25			ns
T_A	Free Air Operating Temperature		0		70	°C

'93A Electrical Characteristics

over recommended operating free air temperature range (unless otherwise noted)

Symbol	Parameter	Conditions	Min	Typ (Note 1)	Max	Units
V_I	Input Clamp Voltage	$V_{CC} = \text{Min}$, $I_I = -12 \text{ mA}$			-1.5	V
V_{OH}	High Level Output Voltage	$V_{CC} = \text{Min}$, $I_{OH} = \text{Max}$ $V_I = \text{Max}$, $V_{OL} = \text{Min}$	2.4	3.4		V
V_{OL}	Low Level Output Voltage	$V_{CC} = \text{Min}$, $I_{OL} = \text{Max}$ $V_{IH} = \text{Min}$, $V_{IL} = \text{Max}$ (Note 4)		0.2	0.4	V
I_I	Input Current @ Max Input Voltage	$V_{CC} = \text{Max}$, $V_I = 5.5 \text{ V}$			1	mA
I_{IH}	High Level Input Current	$V_{CC} = \text{Max}$ $V_I = 2.4 \text{ V}$	Reset		40	μA
			A		80	
			B		80	
I_{IL}	Low Level Input Current	$V_{CC} = \text{Max}$ $V_I = 0.4 \text{ V}$	Reset		-1.6	mA
			A		-3.2	
			B		-3.2	
I_{OS}	Short Circuit Output Current	$V_{CC} = \text{Max}$ (Note 2)	-18		-57	mA
I_{CC}	Supply Current	$V_{CC} = \text{Max}$ (Note 3)		26	38	mA

Note 1: All typicals are at $V_{CC} = 5 \text{ V}$, $T_A = 25^\circ\text{C}$.

Note 2: Not more than one output should be shorted at a time.

Note 3: I_{CC} is measured with all outputs open, both HD inputs grounded following momentary connection to 5.5V and all other inputs grounded.

Note 4: I_{IL} inputs are tested at $I_{OL} = \text{Max}$ plus the test value of I_{OL} for the B input. This permits driving the B input while maintaining full test capability.

Note 5: $T_A = 25^\circ\text{C}$ and $V_{CC} = 5 \text{ V}$.

Absolute Maximum Ratings (Note)

If Military/Aerospace specified devices are required, please contact the National Semiconductor Sales Office/Distributors for availability and specifications.

Supply Voltage	7V
Input Voltage	5.5V
Operating Free Air Temperature Range	
DM54	-55°C to +125°C
DM74	0°C to +70°C
Storage Temperature Range	-65°C to +150°C

Note: The "Absolute Maximum Ratings" are those values beyond which the safety of the device cannot be guaranteed. The device should not be operated at these limits. The parametric values defined in the "Electrical Characteristics" table are not guaranteed at the absolute maximum ratings. The "Recommended Operating Conditions" table will define the conditions for actual device operation.

Recommended Operating Conditions

Symbol	Parameter		DM5490			DM7490A			Units
			Min	Typ	Max	Min	Typ	Max	
V _{CC}	Supply Voltage		4.5	5	5.5	4.75	5	5.25	V
V _{HI}	High Level Input Voltage		2			2			V
V _L	Low Level Input Voltage				0.8			0.8	V
I _{OH}	High Level Output Current				-0.8			-0.8	mA
I _{OL}	Low Level Output Current				16			16	mA
f _{CLK}	Clock Frequency (Note 5)	A	0		32	0		32	MHz
		B	0		16	0		16	
t _{PI}	Pulse Width (Note 5)	A	15			15			ns
		B	30			30			
		Reset	15			15			
t _{RETR}	Reset Release Time (Note 5)		25			25			ns
T _A	Free Air Operating Temperature		-55		125	0		70	°C

'90A Electrical Characteristics

(over recommended operating free air temperature range unless otherwise noted)

Symbol	Parameter	Conditions	Min	Typ (Note 1)	Max	Units
V _I	Input Clamp Voltage	V _{CC} - Min, I _I = -12 mA			-1.5	V
V _{OH}	High Level Output Voltage	V _{CC} - Min, I _{OH} = Max V _L = Max, V _{HI} = Min	2.4	3.4		V
V _{OL}	Low Level Output Voltage	V _{CC} = Min, I _{OL} = Max V _{HI} = Min, V _L = Max (Note 4)		0.2	0.4	V
I _I	Input Current @ Max Input Voltage	V _{CC} = Max, V _I = 5.5V			1	mA
I _{HI}	High Level Input Current	V _{CC} = Max V _I = 2.7V	A		80	μA
			Reset		40	
			B		120	
I _L	Low Level Input Current	V _{CC} = Max V _I = 0.4V	A		-3.2	mA
			Reset		-1.0	
			B		-4.0	
I _{OS}	Short Circuit Output Current	V _{CC} = Max (Note 2)	DM54	-20	-57	mA
			DM74	-18	-57	
I _{CC}	Supply Current	V _{CC} = Max (Note 3)		29	42	mA

Note 1: All outputs are at V_{OL} = 0V, T_A = 25°C.

Note 2: Not more than one output should be shorted at a time.

Note 3: I_{CC} is measured with all outputs open, but RD inputs grounded following momentary connection to 5V, and all other inputs grounded.

Note 4: I_L values are listed at I_{OL} = Max plus the test value of I_I for the B input. This permits driving the B input when maintaining full fan-out capability.

Note 5: T_A = 25°C and f_{CLK} = 5V.



DHARAMPETH M. P. DEO MEMORIAL SCIENCE COLLEGE, NAGPUR

INTERNAL QUALITY ASSURANCE CELL (IQAC)

Activity Report

Date: 25th March 2023

Name of Organizing Department or Committee : Electronics Department

Name of the Activity : Guess the output of the given statements.

Suggested CRITERION point if any : Suggested criteria II

Date of Activity : 25th March 2023

Place of Activity : Electronics Lab

Name of Guest Speaker/s or Judge/s or Chief Guest/s if any : Not applicable

Title of the Activity: Guess the output of the given statements.

Based on Unit : 3(Paper I)

Class : Semester VI

Number of Participants : 18

Name of the Teacher In-charge / Convener: Mrs. Leena P. Thakare

OUTCOME of the Activity with respect to mission vision of the institute and or academics:

Students learn about different types of errors while executing the given statements of C program.

Prof. Pitambar Humane

CO ORDINATOR

INTERNAL QUALITY ASSURANCE CELL
DHARAMPETH, M. P. DEO MEMORIAL &
SCIENCE COLLEGE, NAGPUR

Dr. Vanisha K. Rangari
Professor & Head
Head of the Department
Department of Electronics
Dharampeth M. P. Deo Memorial
Science College, Nagpur

Dr. Akhlesh Peshwe
Principal
Dharampeth M. P. Deo Memorial
Science College, Nagpur.



DHARAMPETH M. P. DEO MEMORIAL SCIENCE COLLEGE, NAGPUR
Department of Electronics
Semester VI- (2022-23)
Activity (Paper I- Unit- 3)

Sr. No.	Student Name	Mobile Number	Email Id
1	Bhavesh Rameshwar Maske	7489951631	bhaveshmaske2002@gmail.com
2	Tanmay Sunil Gadam	7262034396	tanmaygadaml@gmail.com
3	Saurabh Pratap Sharma	9130964601	saurabh44002@gmail.com
4	Nikhil Kiran Ijankar	8530960407	nikhilijankar@gmail.com
5	Mahesh Prabhakar Rao Maske	9021951173	maheshmaske48@gmail.com
6	Pranay Santosh Mahajan	9158377419	pranaymahajan413@gmail.com
7	Rajat Laxman Rohad	9175635273	
8	Mukund Sanjay Hood	9604785822	mukundahood2003@gmail.com
9	Pratham Manbahadur Sonar	7558464862	manbhaisonar@gmail.com
10	Megha Tribhuwan Bisen	9637770341	bisenmegha320@gmail.com
11	Ankita Laxman Sonwane	9284801790	ankitasonwane10@gmail.com
12	Kiran Ramesh Waghade	9860218676	rameshwaghade20@gmail.com
13	Kartik Kamal Parasad Tiwari	9156498206	tiwarikartik292@gmail.com
14	Soniya Bhishamber Chaniya	7028563411	rvchaniya@gmail.com
15	Samiksha Vasant Tabhane	9307133863	samikshavtabhane@gmail.com
16	Rani Devidas Kokate	7998945148	ranikokate1009@gmail.com
17	Sagar Omprakash Sonwane	9356591564	sagarsonwane706@gmail.com
18	Prathmesh Sanju Badhiye	9765262138	nikita24badhiye@gmail.com



Name & Signature of Teacher In-Charge

Prof. Pitambar Humane
IQAC Coordinator

CO ORDINATOR
INTERNAL QUALITY ASSURANCE CELL
DHARAMPETH, M. P. DEO MEMORIAL &
SCIENCE COLLEGE, NAGPUR

Name & Signature of Head of the
Department

Dr. Vafaha V. Rangari
Professor & Head
Department of Electronics
Dharampeth M.P. Deo Memorial
Science College, Nagpur

Dr. Akhilesh Peshwe
Principal
Principal
Dharampeth M.P. Deo Memorial
Science College, Nagpur.



DHARAMPETH M. P. DEO MEMORIAL SCIENCE COLLEGE, NAGPUR
DEPARTMENT OF COMPUTER SCIENCE
ACADEMIC SESSION: 2022-23

NOTICE

10/3/2023

All the students of B.Sc. [SEM VI] are hereby informed that the Department of Computer Science, Dharampeth M.P.Deo Memorial Science College, Nagpur is going to organize Poster Making Activity base Unit II of Paper II[SQL and PL/SQL] on 25/03/2023 . All the students must remain present and participate in this activity.

Venue : Room No.04

Principal
Dharampeth M. P. Deo Memorial
Science College, Nagpur

Head, Department of Computer Science



DHARAMPETH M. P. DEO MEMORIAL SCIENCE COLLEGE, NAGPUR
INTERNAL QUALITY ASSURANCE CELL (IQAC)
NEP Activity Report

Date: 26th March 2023

Name of Organizing Department or Committee: Computer Science Department
Name of the activity: Poster Making Activity
Suggested CRITERION point if any: Criteria II, V
Date of Activity: 25 / 03/2023
Place of Activity: Computer Science Laboratory
Name of Guest Speaker/s or Judge/s or Chief Guest/s if any: Nil
Title of the Activity: PL/SQL Programming for the students of SEM VI on UNIT II [Paper II]
Number of Participants: 40
Name of the Teacher In-charge / Convener: Dr.Mrs.Snehal Narale
Names of other Committee Members / Staff: Nil

OUTCOME of the Activity with respect to mission vision of the institute and or academics:

The objective of this activity was to bring out the creative expression of students and to gauge their knowledge and awareness of PL/SQL programming with respect to the subject. The aim of the Poster Making activity was not just to judge the students based on their creative aspects but also to trigger thought process among the students towards topic of the paper from their point of view. After completion of this activity students understood the concept in more details.

Activity with newspaper coverage if any: Nil

Activity data save in PC of: Dr. Mrs. Snehal Narale's Laptop



Snehal Narale
Dr.Mrs.Snehal Narale

Name & Signature of Teacher In-charge

Pitambar Humane

Prof.Pitambar Humane
IQAC Coordinator
CO ORDINATOR
INTERNAL QUALITY ASSURANCE CELL
DHARAMPETH, M. P. DEO MEMORIAL &
SCIENCE COLLEGE, NAGPUR

Dr. Arkhilesh Peshwe

Dr.Arkhilesh Peshwe
Principal
Principal
Dharampeth M. P. Deo Memorial
Science College, Nagpur



DHARAMPETH M. P. DEO MEMORIAL SCIENCE COLLEGE,
North Ambazari Road, Near Ambazari Lake, Nagour-440033

DATA VALIDATION & VERIFICATION (DVV)

Name of the Programme : Poster making Activity [Sem VI]
Date of the Programme : 25/03/2023
Name of Chief Guest if any : _____
Name of Guest Speaker if any : _____

Sr. No.	Name of the Participant	Mobile Number	E-mail Id	Signature
1	Tanu Sanjay Mahule	7057944932	tanumahule101@gmail.com	Tanumahule
2	Samiksha Dubhane	9301133863	samikhadubhane101@gmail.com	Samiksha
3	Ridhi Rajare	866874021	ridhirajare101@gmail.com	Ridhi
4	Dikshita Sekare	9028830801	dikshitasekare101@gmail.com	Dikshita
5	Khuski A. Gupta	9932997235	kg098030@gmail.com	Khuski
6	Kamal M Kumbhakar	7620314869	Kamalmkumbhakar101@gmail.com	Kamal
7	Neha J. Bankar	8055477553	nehajbankar101@gmail.com	Neha
8	Samiksha Khasare	9604473539	rekha.khasare@gmail.com	Samiksha
9	Pranay Mahajan	7385551492	Pranaymahajan613@gmail.com	Pranay
10	Pratham Sonar	7558461862	Sonapratam101@gmail.com	Pratham

Signature of: [Signature]
Programme In-charge

[Signature]
IQAC Coordinator
CO-ORDINATOR
INTERNAL QUALITY ASSURANCE CELL
DHARAMPETH M. P. DEO MEMORIAL &
SCIENCE COLLEGE, NAGOUR

[Signature]
Principal
Principal
Dharampeth M. P. Deo Memorial
Science College, Nagour



DHARAMPETH M. P. DEO MEMORIAL SCIENCE COLLEGE,
North Ambazari Road, Near Ambazari Lake, Nagpur - 440033

DATA VALIDATION & VERIFICATION (DVV)

11	Rajat Rohad	9135635273	RajitRohad13@gmail.com	Rajad
12	Mukund S. Hood	9600785822	mukundhoods005@gmail.com	M Hood
13	Akash Das	7972942799	akash@gmail.com	Kund
16	Mahesh. P. Maske	9021951173	maheshmaske1@gmail.com	Maske
14	Nikhil K. Jankar	8530960407	nikhiljankar2@gmail.com	Jankar
18	Prakash Khanal	9011509643	prakash220khanal@gmail.com	Prakash
19	Abhishek A. Falke	7823835535	abhishekfalke1990@gmail.com	Falke
20	Tanmay S. Gadam	7262034396	tanmaygadani@gmail.com	T.S. gadam
21	Pransy S. Dore	8055292863	pransydore17@gmail.com	Dore
22	Abdul Raheem Aman	7666938578	rahman201@gmail.com	Rahman
23	Bhavesh B. Maske	7583951631	bhaveshmaske2002@gmail.com	Bhavesh M.
24	Ruchita Bhojani	9527832688	ruchitabhojan@gmail.com	Bhojani
25	Khushi Dave	9890009937	kd2521411@gmail	Khushi
26	Bronjal Sanudkar	7385456510	bronjal011294@gmail.com	Bronjal
27	Diya Patil	7757052463	diyapatil552@gmail.com	Patil

Signature of:

Program in-charge

IQAC Coordinator
CO ORDINATOR
INTERNAL QUALITY ASSURANCE CELL
DHARAMPETH M. P. DEO MEMORIAL &
SCIENCE COLLEGE, NAGPUR

Principal
Dharampeth M. P. Deo Memorial
Science College, Nagpur



DHARAMPETH M. P. DEO MEMORIAL SCIENCE COLLEGE,
North Ambazari Road, Near Ambazari Lake, Nagpur- 440033

DATA VALIDATION & VERIFICATION (DVV)

28	Sahil R. Jintode	93734114643	sahiljintode21@gmail.com	Jintode
29	Sanchit M. Joshi	8975706788	sanchit.joshi01@gmail.com	Joshi
30	Jatang P. Panke	9422488044	Jatangpanke2001@gmail.com	Panke
31	Rishikesh R. Datta	8788199360	rishikeshdatta2002@gmail.com	Datta
32	Sakshi S. Huddar	9406142450	huddarsakshi@gmail.com	Huddar
33	Saurabh V. Raut	9529283213	SaurabhRaut123@gmail.com	Raut
34	Kaustik Tiwari	9156498206	KaustikTiwari29@gmail.com	Tiwari
35	Vishal Girhale	9673681472	vishalgirhale@gmail.com	Girhale
36	Abhishek A. Patil	7824633225	abhishekpattal@gmail.com	Patil
36	Ashray V. GIRHE	9404418055	ashraygirhe@gmail.com	Girhe
37	Sumeet Bhalekar	9021627757	SumeetBhalekar2630@gmail.com	Bhalekar
38	Bhawesh D. Mathur	9021317066	bhaweshmathur@gmail.com	Mathur
39	Aarti B. Singh	7709208140	AartiSingh22@gmail.com	Singh
40	Sujata Pramraj Sawane	9021135110	sujatasawane2001@gmail.com	Sawane

Signature of:

Programme In-charge

IQAC Coordinator
CO ORDINATOR
INTERNAL QUALITY ASSURANCE CELL
DHARAMPETH M. P. DEO MEMORIAL &
SCIENCE COLLEGE, NAGPUR

Principal
Dharampeth M. P. Deo Memorial
Science College, Nagpur



DHARAMPETH M. P. DEO MEMORIAL SCIENCE COLLEGE
INTERNAL QUALITY ASSURANCE CELL (IQAC)
Activity Report

Date : 29th March 2023

Name of The Organizing Department or Committee : Electronics Department

Name of the Activity : Seminar

Suggested CRITERION point if any : Suggested criterion II

Date of Activity : 29th March 2023

Place of Activity : Electronics Lab

Name of Guest Speaker/s or Judge/s or Chief Guest/s if any : Not applicable

Title of the Activity : Seminar

Based on Unit : 2(Paper I)

Class : Semester IV

Number of Participants : 11

Name of the Teacher In -charge/Convener : Prof. V. V. Rangari

OUTCOME of the Activity with respect to mission vision of the institute and or academic :

Students studied the given topic and presented using the power point presentation. Students learned how to improve their communication skills.

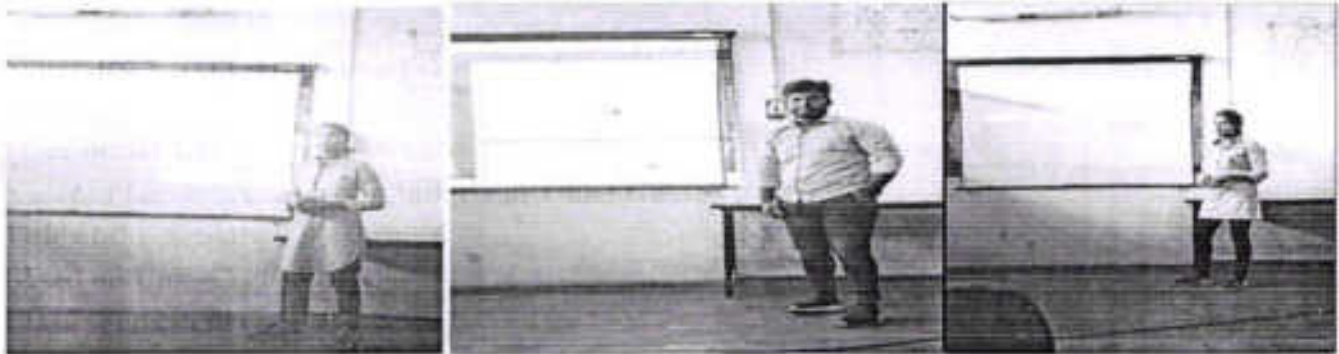

Prof. V. V. Rangari

Head of the Department



Prof. Pitambar Humne

IQAC Cordinator
CO ORDINATOR

INTERNAL QUALITY ASSURANCE CELL
DHARAMPETH, M. P. DEO MEMORIAL &
SCIENCE COLLEGE, NAGPUR

Dr. Akhilesh Peshwe

Principal
Principal

Dharampeth M.P. Deo Memorial
Science College, Nagpur.



DHARAMPETH M. P. DEO MEMORIAL SCIENCE COLLEGE, NAGPUR
Department of Electronics
Semester IV- (2022-23)
Activity (Paper I- Unit- 2)

Sr. No.	FullName	Student Mobile No	StudentEmailId
1	Rahul Ramesh Kawade	9359525716	kawaderahul042@gmail.com
2	Pratham Ankush Sitkare	9022553288	prathamsitkare@gmail.com
3	Tushar Wadhve		
4	Renuka Vishal Lande	7719951401	renukalande220@gmail.com
5	Janvi Ashok Kosarkar	8975756916	Janvikosarkar@gmail.com
6	Bhagyarathi Ramvinay Pandey	9175302601	pandeybhagyarathi@gmail.com
7	Mansi Dilip Nandanwar	7709322027	mansinandanwar19@gmail.com
8	Urvashi Sunilrao Umathe	9527708361	pragatichaure01@gmail.com
9	Aasmin Abdulkhalik Sheikh	8788490684	abdulkhalik563698@gmail.com
10	Jay Anilbhai Patil	7385436956	jay.patil0326@gmail.com
11	Unnatitai Chatrapal Chopde	9022627617	unnatichopde2002@gmail.com

Name & Signature of Teacher In-Charge



Prof. Pitambar Humane
IQAC Coordinator
CO ORDINATOR

INTERNAL QUALITY ASSURANCE CELL
DHARAMPETH, M. P. DEO MEMORIAL &
SCIENCE COLLEGE, NAGPUR

Name & Signature of Head of the Department

J. Varsita V. Rangari
Professor & Head
Department of Electronics
Dharampeth M.P. Deo Memorial
Science College, Nagpur

Dr. Akhilesh Peshwe
Principal

Principal
Dharampeth M.P. Deo Memorial
Science College, Nagpur.



Activity Report

Date: 31st March., 2023

Name of Organizing Department or committee: BOTANY DEPARTMENT

Name of the activity: POSTER COMPETITION

Suggested CRITERION point if any: Criterion-1

Date of Activity: 29th March, 2023

Place of Activity: DEPARTMENT OF BOTANY

Name of Guest Speaker/s or Judge/s of Chief Guest/s if any: Prof. Pitambar Humane

Title of the activity: Poster competition on interaction of genes

Number of Participants: 41

Name of the Teacher In-charge/ Convener: Mrs. Dipali Nikure

Name of the other committee members / Staff: Dr. Mrs. Reshma Hiwase, Dr. Mrs. Sweta Rai

OUTCOME of the Activity with respect to mission vision of the institute and or academics:
Poster helps to develop the skills throughout the student's life. Competition really gives students a sense of achievement and pride within themselves. Poster competition provides a boost to their self confidence and self esteem with knowledge of that subject.

Activity with newspaper converge if any: N A

Activity data save in PC of: DEPT OF BOTANY



Prof. Pitambar Humane

IQAC Coordinator

CO ORDINATOR

INTERNAL QUALITY ASSURANCE CELL
DHARAMPETH M. P. DEO MEMORIAL &
SCIENCE COLLEGE, NAGPUR

Name & Signature of Teacher In-charge

Dr. Akbilesh Peshwe

Principal

Dharampeth M.P. Deo Memorial
Science College, Nagpur.



DHARAMPETH M. P. DEO MEMORIAL SCIENCE COLLEGE,
North Ambazari Road, Near Ambazari Lake, Nagpur- 440033

DATA VALIDATION & VERIFICATION (DVV)

Name of the Programme : Poster Competition on Interaction of gene
 Date of the Programme : 29/03/2023
 Name of Chief Guest if any : _____
 Name of Guest Speaker if any : _____

Sr. No.	Name of the Participant	Mobile Number	E-mail Id	Signature
1.	Mkrita Mishra	8421299176	mishraamkrita4685@gmail.com	<u>Mishra</u>
2.	Asmita Charjan	87387005732	asmitacharjan25@gmail.com	<u>Charjan</u>
3.	Muskan R. Yadav	9579492617	muskan.yadav1228@gmail.com	<u>Yadav</u>
4.	Devashri D. Bisen	7773980643	Dk.Bisen29@gmail.com	<u>Bisen</u>
5.	Devanshish Bisen	7769861231	DKBisen74@gmail.com	<u>Bisen</u>
6.	Khushbu Chaudhary	77786643	khushbu@gmail.com	<u>Chaudhary</u>
7.	Muhammadini Ramteke	9146003783	muhammadiniRamteke@gmail.com	<u>Ramteke</u>
8.	Abhishek Dabhbhatore	8208302902	abhishek.dabhbhatore@gmail.com	<u>Abhishek</u>
9.	Nikhil R. Pant	9022680159	pantnr0541@gmail.com	<u>Pant</u>
10.	Ashlesha Sangade	9503998469	Ashlesha.sangade.94	<u>Sangade</u>
11.	Nilesh Kulkarni	8624091652	kulkarninilesh@gmail.com	<u>Kulkarni</u>
12.	Aditya Dalkar	9022415716	dalkaraditya27@gmail.com	<u>Dalkar</u>
13.	Ketaki Kespal	9112759066	KetakiKespal13@gmail.com	<u>Kespal</u>
14.	Abina Sheikh	8080083981	abinasheikh973@gmail.com	<u>Sheikh</u>

Signature of:

Programme In-charge

[Signature]

IQAC Coordinator

INTERNAL QUALITY ASSURANCE CELL
DHARAMPETH M. P. DEO MEMORIAL SCIENCE COLLEGE

Principal

Dharampeth Memorial Science College, Nagpur.



DHARAMPETH M. P. DEO MEMORIAL SCIENCE COLLEGE,
North Ambazari Road, Near Ambazari Lake, Nagpur- 440033

DATA VALIDATION & VERIFICATION (DVV)

Sr. No.	Name of the Participant	Mobile Number	E-mail Id	Signature
15	Smruti Vaidya	8856908764	Smruti.Vaidya.SG@gmail.com	Smruti Vaidya
16	Anushree Chandel	914563444	anuchandel2001@gmail.com	Anushree Chandel
17	Shital G. Bankar	7758055139	Shitalbankar122@gmail.com	S.G. Bankar
18	Chirayu B. Dalal	8010135012	Chirayudalal22@gmail.com	Chirayu Dalal
19	Kalyani C. Shahare	9307046378	Shahare Kalyani S@gmail.com	Kalyani Shahare
20	Sugaa S. Bawane	9975460979	sugaasbawane437@gmail.com	S.Bawane
21	Vaibhav A. Malekar	8767838219	vaibhavamalekar794@gmail.com	Vaibhav Malekar
22	Nikita S. Bhawe	7820812749	nikitabhawe98@gmail.com	Nikita Bhawe
23	Harchal S. Singh	7875537925	Sandeshsingh9392@gmail.com	Harchal Singh
24	Somir P. Ghumde	9350236713	Somirghumde0026@gmail.com	S.P. Ghumde
25	Aniket .V. Kulkade	7709623106	akulkade61@gmail.com	Aniket Kulkade
26	Darsh .S. Longadje	9326246453	darshlongadje@gmail.com	Darsh Longadje
27	Vaishnavi T. Kapse	8988751089	vaishnavikapase05@gmail.com	Vaishnavi Kapse
28	Pratiksha S. Naughaze	8623033760	Naughazepratiksha44@gmail.com	P.S. Naughaze
29	Suruti .S. Longadje	8390576517	surutiLongadje1@gmail.com	Suruti Longadje
30	Arushi Raut	9767873447	arushiraut2003@gmail.com	Arushi Raut
31	Janavi .J. Rathore	7263819173	JanaviRathore21@gmail.com	Janavi Rathore
32	Pallavi Boskar	9373187246	PallaviBoskar@gmail.com	Pallavi Boskar

Signature of:

Programme In-charge

IQAC Coordinator

CO-ORDINATOR
INTER-UNIVERSITY ASSISTANCE CELL
DHARAMPETH, M. P. DEO MEMORIAL SCIENCE COLLEGE, NAGPUR

Principal
Dharampeth M. P. Deo Memorial
Science College, Nagpur.



DHARAMPETH M. P. DEO MEMORIAL SCIENCE COLLEGE,
North Ambazari Road, Near Ambazari Lake, Nagpur- 440033

DATA VALIDATION & VERIFICATION (DVV)

Sr. No.	Name of the Participant	Mobile Number	E-mail Id	Signature
33	Rushabh Chaudhari	7218862335	chaudharirushabha	R. Chaudhari.
34	Yashraj P. Chavde	9769001966	yashrajchavde@gmail	Y.P.C
35	Vaishali S. Patle	9822600447	vaishalipatle176@gmail	V. Patle..
36	Varsha R. Tiwari	8408092938	varshatiwari722@gmail	Varsha
37	Subbu R. Mishra	9860436418	subbumishra234@gmail	Subbu
38	Sushma G. Gurnur	9156238747	sushmagurnur@gmail	Sushma
39	Shikha Yadav	7263881320	shikhayadav@gmail	S. Yadav
40	Nikita S. Bavapatule	7058625053	nikitabavapatule@gmail	N. Bavapatule
41	Nilesh D. Hulle	8624091652	hulkenilesh@gmail	Hulle
42				
43				
44				
45				
46				
47				
48				
49				
50				

Signature of:

Programme In-charge

CO ORDINATOR

IQAC Coordinator

INTERNAL QUALITY ASSURANCE CELL
DHARAMPETH M. P. DEO MEMORIAL &
SCIENCE COLLEGE, NAGPUR

Principal

Dharampeth M. P. Deo Memorial
Science College, Nagpur.



DHARAMPETH M. P. DEO MEMORIAL SCIENCE COLLEGE, NAGPUR
INTERNAL QUALITY ASSURANCE CELL (IQAC)

Activity Report

Date: 31st March., 2023

Name of Organizing Department or committee: BOTANY DEPARTMENT

Name of the activity: WORD PUZZLE

Suggested CRITERION point if any: Criterion-I

Date of Activity: 29th March, 2023

Place of Activity: DEPARTMENT OF BOTANY

Name of Guest Speaker/s or Judge/s of Chief Guest/s if any: Prof. Pitambar Humane

Title of the activity: To prepare word puzzle on Genetics

Number of Participants: 40

Name of the Teacher In-charge/Convener: Mrs. Dipali Nikure

Name of the other committee members / Staff: Dr. Mrs. Reshma Hiwase, Dr. Mrs. Sweta Rai

OUTCOME of the Activity with respect to mission vision of the institute and or academics:
Word puzzles help to develop the skills in students. Word puzzle can be very useful for students to master the vocabulary of a particular discipline and it can be used to memorize or review important terms.

Activity with newspaper converge if any: N A

Activity data save in PC of: BOTANY DEPARTMENT



Prof. Pitambar Humane
IQAC Coordinator

INTERNAL QUALITY ASSURANCE CELL
DHARAMPETH M. P. DEO MEMORIAL &
SCIENCE COLLEGE, NAGPUR

Name & Signature of Teacher In-charge

Dr. Akhilesh Peshwe
Principal

Dharampeth M.P. Deo Memorial
Science College, Nagpur.



DHARAMPETH M. P. DEO MEMORIAL SCIENCE COLLEGE,
North Ambazari Road, Near Ambazari Lake, Nagpur- 440033

DATA VALIDATION & VERIFICATION (DVV)

Name of the Programme : To prepare word puzzle on Genetics
Date of the Programme : 29/03/2023
Name of Chief Guest if any : _____
Name of Guest Speaker if any : _____

Sr. No.	Name of the Participant	Mobile Number	E-mail Id	Signature
1.	Asmita D. Chhajjan	7387005732	asmitachhajjan25@gmail.com	Asmita
2.	Ankita M. Mishra	9421893176	mishraankita@gmail.com	Amishra
3.	Khushabu H. Choudhary	7262074960	khushabuchoudhary38@gmail.com	KHUSHABU
4.	Abhishek Ashbhatkar	9208302902	abhishekashbhatkar@gmail.com	Abhis
5.	Nikhil R. Raut	9022680159	rautn6541@gmail.com	N Raut
6.	Muskan R. Yadav	9579492617	muskanyadav1228@gmail.com	Muskan
7.	Aditya A. Deulkar	9028915776	deulkaraditya27@gmail.com	Aditya
8.	Musunalmi S. Ramteke	9146003783	musunalmiramteke0828@gmail.com	M Ramteke
9.	Devashri Bisen	7173386643	DrBisen76@gmail.com	Dr Bisen
10.	Devashri Bisen	7767861231	DrBisen76@gmail.com	Dr Bisen
11.	Ashlesha Sangole	9503998469	Ashleshasangole94@gmail.com	A Sangole
12.	Nilesh Hulke	8624091652	hulkenilesh@gmail.com	Nilesh
13.	Sameer P. Ghumde	9359236713	Sameerghumde2002@gmail.com	S Ghumde
14.	Aniket V. Kurade	7741945323	Akurade61@gmail.com	Aniket

Signature of:

Programme In-charge

IQAC Coordinator

Principal

Dharampeth M. P. Deo Memorial
Science College, Nagpur



DHARAMPETH M. P. DEO MEMORIAL SCIENCE COLLEGE,
North Ambazari Road, Near Ambazari Lake, Nagpur- 440033

DATA VALIDATION & VERIFICATION (DVV)

Sr. No.	Name of the Participant	Mobile Number	E-mail Id	Signature
15	Devesh Longadge	9326246453	deveshlongadge@gmail.com	
16	Pratiksha S. Naughare	8623033760	NaugharePratiksha@gmail.com	P.S. Naughare
17	Seethi S. Longadge	8390516517	Seethilongadge@gmail.com	
18)	Vaishnavi T. Kapse	8983751089	Vaishnavikapse05@gmail.com	Vaishnavi
19	Ketaki R. Kikfal	9112759066	ketaki.kikfal12@gmail.com	
20	Apina Sheikh	80800833981	abinashsheikh973@gmail.com	
21	Smruti Vaidya	8856908764	SmrutiVaidya36@gmail.com	Smruti Vaidya
22	Anushree Chandel	9191631751	anuchandel2001@gmail.com	Anushree
23	Shital G. Bankar	7758055139	Shitalbankar122@gmail.com	S.G. Bankar
24	Kalyani C. Shahare	9307046378	Shaharekalyani5@gmail.com	
25	Sagar S. Bawane	9975460979	Sagarbawane637@gmail.com	S. Bawane
26	Chirayu B. Dolat	8010133012	chirayudolat22@gmail.com	B. Dolat
27	Vaibhav A. Malekar	87678388219	vaibhavmalekar194@gmail.com	V. Malekar
28	Nikita S. Bhave	7820812749	nikita.bhave.98@gmail.com	N. Bhave
29	Hanchal S. Singh	7875537925	SantoshSingh23923@gmail.com	Hanchal Singh
30	Janani V. Rathod	8263819143	JananiRathod@gmail.com	J. Rathod
31	Arushi Raut	9767873447	arushiraut2003@gmail.com	A. Raut
32	Pallavi Borkar	9373187246	Pallaviborkar@gmail.com	Pallavi

Signature of:
Programme In-charge

IQAC Coordinator

INTERNAL QUALITY ASSURANCE CELL
DHARAMPETH, M. P. DEO MEMORIAL &
SCIENCE COLLEGE, NAGPUR

Dharampeth Memorial
Science College, Nagpur



Activity Report

Date: 31st March., 2023

Name of Organizing Department or committee: BOTANY DEPARTMENT

Name of the activity: WORD PUZZLE

Suggested CRITERION point if any: Criterion-1

Date of Activity: 29th March, 2023

Place of Activity: DEPARTMENT OF BOTANY

Name of Guest Speaker/s or Judge/s of Chief Guest/s if any: Prof. Pitambar Humane

Title of the activity: To prepare word puzzle on Molecular Biology

Number of Participants:-40

Name of the Teacher In-charge/Convener: Mrs. Dipali Nikure

Name of the other committee members / Staff: Dr. Mrs. Reshma Hiwase

OUTCOME of the Activity with respect to mission vision of the institute and or academics:
Word puzzles help to develop the skills in students. Word puzzle can be very useful for students to master the vocabulary of a particular discipline and it can be used to memorize or review important terms.

Activity with newspaper converge if any: N A

Activity data save in PC of: BOTANY DEPARTMENT

Prof. Pitambar Humane
IQAC Coordinator

CO ORDINATOR
INTERNAL QUALITY ASSURANCE CELL
DHARAMPETH M. P. DEO MEMORIAL &
SCIENCE COLLEGE, NAGPUR

Name & Signature of Teacher In-charge

Dr. Akhilesh Peshwe
Principal
Principal

Dharampeth M.P. Deo Memorial
Science College, Nagpur.



DHARAMPETH M. P. DEO MEMORIAL SCIENCE COLLEGE,
North Ambazari Road, Near Ambazari Lake, Nagpur- 440033

DATA VALIDATION & VERIFICATION (DVV)

Name of the Programme : To prepare word puzzles on Molecular Biology
Date of the Programme : 29/03/2023
Name of Chief Guest if any : _____
Name of Guest Speaker if any : _____

Sr. No.	Name of the Participant	Mobile Number	E-mail Id	Signature
1.	Khushabu H. Choudhary	7262094860	khushabuchoudhary28@gmail.com	
2.	Aankita Mishra	8421299176	mishraaankita4028@gmail.com	
3.	Abhishek Deshbhaskar	9205302902	abhishekdeshbhaskar@gmail.com	
4.	Asmita D. Charjan	7887005732	asmitacharjan95@gmail.com	
5.	Nikhil R. Raut	9022690159	cautn6541@gmail.com	
6.	Muskan R. Yadav	9579492617	maskanyadav128@gmail.com	
7.	Devanshi D. Bisem	7773980649	DKBisem74@gmail.com	
8.	Devanshik Bisem	7767867831	devbisem74@gmail.com	
9.	Aditya Dalkar	9028915776	dalkaraditya12@gmail.com	
10.	Mounalini S. Ramteke	9146003783	mounalinaranteke1028@gmail.com	
11.	Ashwika Sangeet	9503998469	Ashwikhasangeet99@gmail.com	
12.	Nilesh Hulke	90284158409	hulkenilesh@gmail.com	
13.	Vaishnavi Kapse	8983751089	Vaishnavikapse05@gmail.com	
14.	Samir P. Ghumde	9359286723	Samirghumde202@gmail.com	

Signature of:

Programme In-charge

IQAC Coordinator

MEMORIAL & SCIENCE COLLEGE, NAGPUR

Principal
Memorial Science College, Nagpur.



DHARAMPETH M. P. DEO MEMORIAL SCIENCE COLLEGE,
North Ambazari Road, Near Ambazari Lake, Nagpur- 440033

DATA VALIDATION & VERIFICATION (DVV)

Sr. No.	Name of the Participant	Mobile Number	E-mail Id	Signature
15	Pratiksha S. Naughare	8623033760	PratikshaNaughare54@gmail.com	P.S. Naughare
16	Swati S. Longadye	8350516517	Swatilenpedgedi@gmail.com	Swati
17	Dवेश S. Longadye	9826266453	DवेशLongadye@gmail.com	Dवेश
18	Aniket V. Kukade	7741345323	AKukade61@gmail.com	Aniket
19	Alvina Sheikh	8080083981	alvinaSheikh93@gmail.com	Alvina
20	Arushree Chandel	9145681711	arushreechandel10@gmail.com	Arushree
21	Smriti Vaidya	8856908764	SmritiVaidya36@gmail.com	Smriti
22	Ketaki Khatke	9112759066	KetakiKhatke12@gmail.com	Ketaki
23	Kalyani C. Shahare	9307046378	ShahareKalyani9@gmail.com	Kalyani
24	Shital G. Bankar	7750055139	Shitalbankar122@gmail.com	S.G. Bankar
25	Sugae S. Bawane	9975460479	SugaeBawane637@gmail.com	S.S. Bawane
26	Chirayu B. Dolat	8010135012	chirayudolat122@gmail.com	Chirayu
27	Vaibhavi A. Malewar	8767835219	vaibhavamalewar194@gmail.com	Vaibhavi
28	Nikita S. Bhave	7820812749	nikitabhav98@gmail.com	Nikita
29	Aranchal S. Singh	7875537925	SantoshSingh23923@gmail.com	Aranchal Singh
30	Janavi V. Rathore	7263819173	Janavirathore@gmail.com	Janavi
31	Ankur Pawar	916127344	ankurpawar2003@gmail.com	Ankur
32	Pallavi Borkar	9393189246	Pallaviborkar@gmail.com	Pallavi

Signature of:

Programme In-charge

CO-ORDINATOR
IQAC Coordinator

INTER-UNIVERSITY ASSISTANCE CELL
DHARAMPETH, M. P. DEO MEMORIAL &
SCIENCE COLLEGE, NAGPUR

Principal

Dharampeth M. P. Deo Memorial
Science College, Nagpur



DHARAMPETH M. P. DEO MEMORIAL SCIENCE COLLEGE, NAGPUR
INTERNAL QUALITY ASSURANCE CELL (IQAC)
Activity Report

Date: 29/03/2023

Name of Organizing Department or Committee: Department of Microbiology

Name of the activity: Model making competition.

Suggested CRITERION point if any: π and γ

Date of Activity: 29/03/2023

Place of Activity: Department of Microbiology Dharampeth MP Deo Memorial Science College, Nagpur

Name of Guest Speaker/s or Judge/s or Chief Guest/s if any: Nil

Title of the Activity: Model making competition on paper II unit II for Sem IV students.

Number of Participants: 51

Name of the Teacher In-charge / Convener: Dr. Pratiksha V. Pohekar

Names of other Committee Members / Staff:

OUTCOME of the Activity with respect to mission vision of the institute and or academics:

- The best advantage of model making is that it facilitates team work and understanding along with facilitating creative thinking and reading.
- It provides students with an opportunity to learn by doing, in turn strengthening the learning.
- Students are able to visually represent the key points and while presenting elaborate on the same which facilitates their retention and recall of events and facts.



Name & Signature of Teacher In-charge
 Dr. Pratiksha V. Pohekar

Dr. U. R. Kathoke
 HOD Head
 Deptt. of Microbiology
 Dharampeth MP Deo Memorial
 Science College, Nagpur

COORDINATOR
INTERNAL QUALITY ASSURANCE CELL
DHARAMPETH, M. P. DEO MEMORIAL &
SCIENCE COLLEGE, NAGPUR

Dr. Akhilesh Peshwe

Principal
 Dharampeth M. P. Deo Memorial
 Science College, Nagpur



DATA VALIDATION & VERIFICATION (DVV)

Name of the Programme : Model making competition
 Date of the Programme : 29/03/23 (Sun IV)
 Name of Chief Guest if any : _____
 Name of Guest Speaker if any : _____

Sr. No.	Name of the Participant	Mobile Number	E-mail Id	Signature
	Nikita. S. Bhave	7820812749	nikitabhav9@gmail.com	
	Hanchal. S. Singh	7875537925	Sudesh.singh2392@gmail.com	Hanchal Singh
	Chirayu B. Dolas	8010135012	chirayudolas22@gmail.com	
	Vaibhav A. Malekar	8767838219	vaibhavamalekar194@gmail.com	
	AMAN. A. DONGRE	7709217312	amandongre2003@gmail.com	
	vaishnavi. J. Bedade	8830107397	vaishnavibedade100@gmail.com	
	Darshana S. Madavi	8830146516	Darshanamadavi@gmail.com	
	Juhi S. Chaudhari	8669248946	chaudharijuhi120@gmail.com	
	Mansi I. Mate	8468891807	mansi19182@gmail.com	
	Samir P. Ghumde	9359236713	sameerghum2002@gmail.com	

Signature of:

Programme In-charge

I.Q.A. COORDINATOR
INTERNAL QUALITY ASSURANCE CELL
DHARAMPETH, M. P. DEO MEMORIAL &
SCIENCE COLLEGE, NAGPUR

Principal

Dharampeth M. P. Deo Memorial



DHARAMPETH M. P. DEO MEMORIAL SCIENCE COLLEGE,
North Ambazari Road, Near Ambazari Lake, Nagpur- 440033

DATA VALIDATION & VERIFICATION (DVV)

Sakshi S. Meshuam	9145355733	sakshimeshuam20@gmail.com	Sakshi
Jagruti D. Warkar	7447366023	jjagrutiwarkar09@gmail.com	Jagruti
Pratiksha S. Naughare	8623033760	NaugharePratiksha@gmail.com	Pratiksha
Kalyani C. Shahare	9307046378	ShahareKalyani5@gmail.com	Kalyani
Suruti S. Longadge	8390516517	surutibngadg@gmail.com	Suruti
Vishakha Basule	8329639834	Vishakhabasule1@gmail.com	Vishakha
Chhakuli Wadikar	9325047907	chhakuliwadikar@gmail.com	Chhakuli
Mansi Raut	7385114931	mansiraut@gmail.com	Mansi Raut
Pooja Tankar	9150973252	poojaitankar907@gmail.com	Pooja
Tina Rahangdale			
Twinkal Lokhande		twinkalokhande@gmail.com	Twinkal
Domila Bandre	9870673867	bandrevarnila.2008@gmail.com	Domila
Shreyas Dhawale	8889264004	Shreyasdhawale124@gmail.com	Shreyas
Vaibhavi Shende	8080760482	Vaibhavishende.97@gmail.com	Vaibhavi
Vaishnavi Lakhe	8669594864	chhakuli lakhe 836@gmail.com	Vaishnavi
Kalpana Suhagpure	9579236712	Kalpanasuhagpure7@gmail.com	Kalpana

Signature of:

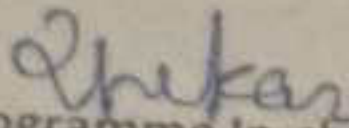
Programme In-charge

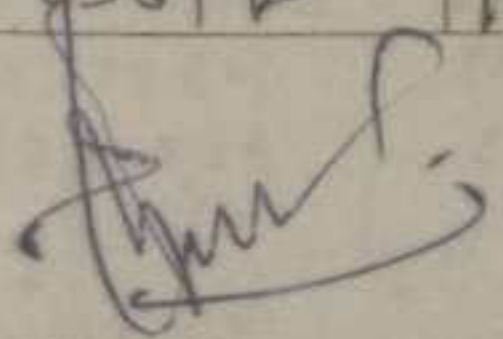
IQAC Coordinator

CO-ORDINATOR
INTERNAL QUALITY ASSURANCE CELL
DHARAMPETH, M. P. DEO MEMORIAL &
SCIENCE COLLEGE, NAGPUR

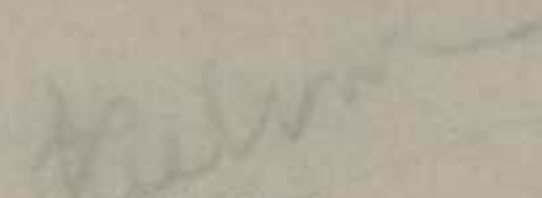
Principal

Principal
Dharampeth M. P. Deo Memorial
Science College Nagpur



DATA VALIDATION & VERIFICATION (DVV)

Vaishnavi T. Kapse	8983751089	vaishnavikapse00@gmail.com	Vaishnavi
Shital G. Bankar	7758055139	shitalbankar2723@gmail.com	Shital Bankar
Gangji Hadge	7972076671	gangjhadge@gmail.com	Gangji
Vaishnavi Gadge	9022976449	gadgavaishnavi00@gmail.com	Vaishnavi
Prajwal Bhoyar	8010434634	prajwalb738@gmail.com	Prajwal
Harsh Kodape	96064677672	harshkodape008@gmail.com	Harsh
Kedant Bary	8530455796	Barykedant2003@gmail.com	Kedant
Jyoti Sharma	8669736380	jyoti58390@gmail.com	Jyoti Sharma
Sania Raza	8975726700	niddhakarania@gmail.com	Sania
Siddharth Hirkan	9579092931	hirkanesiddharth@gmail.com	Siddharth
Sagar S. Bawane	9975460979	sagarbawane637@gmail.com	Sagar
Anjali A. Mishra	9825604513	anjulbmishra2016@gmail.com	Anjali
Vaishnavi Nandapure	4322439316	vaishnavi.nandapure@gmail.com	Vaishnavi
Niket Phakre	9928899087	niketphakre01@gmail.com	Niket
Shrawani Lalakhole	9058338937	shrawani.lalakhole@gmail.com	Shrawani
Rupesh Bhokre	8456493400	Rupeshbhokre@gmail.com	Rupesh
Rohit A. Parate	9573097285	Parate.rohit8@gmail.com	Rohit Parate
Shubham C. Bisen	7448289544	shubham01bisen@gmail.com	Shubham

Signature of:

Shubham C. Bisen
Programme In-charge

[Signature]
IQAC Coordinator

Principal



Activity Report

Date: 29/03/2023

Name of Organizing Department or Committee: Department of Microbiology

Name of the activity: Charts making competition on biosensors and biochips.

Suggested CRITERION point if any: II and V

Date of Activity: 29/03/2023

Place of Activity: Department of Microbiology Dharampeth MP Deo Memorial Science College, Nagpur

Name of Guest Speaker/s or Judge/s or Chief Guest/s if any: Nil

Title of the Activity: Chartsmaking competition on paper II unit IV for Sem VI students.

Number of Participants: 33

Name of the Teacher In-charge / Convener: Dr. Pratiksha V. Pohekar

Names of other Committee Members / Staff:

OUTCOME of the Activity with respect to mission vision of the institute and or academics:

- Charts making competition are used to motivate students to learn specific topics.
- The best advantage of poster making is that it facilitates team work and understanding along with facilitating creative thinking and reading.
- It provides students with an opportunity to learn by doing, in turn strengthening the learning.



Name & Signature of Teacher In-charge
Dr. Pratiksha V. Pohekar

HOD

Dr. V. R. Kulkarni
Head
Deptt. of Microbiology
Dharampeth MP Deo Memorial
Science College, Nagpur

Prof. Pitambar Humane

IQAC Coordinator

Dr. Akhilesh Peshwe

Principal

Dharampeth M. P. Deo Memorial
Science College, Nagpur

CO-ORDINATOR
INTERNAL QUALITY ASSURANCE CELL
DHARAMPETH, M. P. DEO MEMORIAL &
SCIENCE COLLEGE, NAGPUR



DHARAMPETH M. P. DEO MEMORIAL SCIENCE COLLEGE,
North Ambazari Road, Near Ambazari Lake, Nagpur- 440033

DATA VALIDATION & VERIFICATION (DVV)

Name of the Programme : charts on biosensors and biochips
 Date of the Programme : 29/03/23 (BEM VI Students)
 Name of Chief Guest if any :
 Name of Guest Speaker if any :

Sr. No.	Name of the Participant	Mobile Number	E-mail Id	Signature
	Ayushi Shukla	9373668043	ayushishukla28112002@gmail.com	
	Rinam C Wankhede	8010966529	wankhederinam@gmail.com	
	Madhura Bhondure	8767484914	madhurasbhondure@gmail.com	
	Samiksha N. Jandekar	9145253758	Samikshajandekar@gmail.com	
	Samiksha R. Chaudhari	7517090406	Shreyasham@gmail.com	
	Sayali Lokhande	9356413804	SayaliLokhande291@gmail.com	
	Charabi Bhagat	7558367348	charabibhagat456@gmail.com	
	Ashta Sakharwade	9405197842	asthasakharwade@gmail.com	
	Priyanshi Dande	9325473318	priyanshi@gmail.com	
	Avanti Chaphekar	7875178847	avanti1011@gmail.com	

Signature of:

Programme In-charge

IQAC COORDINATOR
INTERNAL QUALITY ASSURANCE CELL
DHARAMPETH, M. P. DEO MEMORIAL &
SCIENCE COLLEGE, NAGPUR

Principal
Dharampeth M. P. Deo Memorial
Science College Nagpur



DHARAMPETH M. P. DEO MEMORIAL SCIENCE COLLEGE,
North Ambazari Road, Near Ambazari Lake, Nagpur- 440033

DATA VALIDATION & VERIFICATION (DVV)

Roshani M. Bamsal	9325853408	roshani2018bh@gmail.com	Bamsal
Laxmi M. Joshi	77505251	laxmijoshi2302@gmail.com	Joshi
Nandini S. Hadge	9379301619	nandinihadge17@gmail.com	Hadge
Ishika S. Thakre	800907069	ishithakre22@gmail.com	Thakre
Bhargavi A. Sambare	7709403806	bhargavisambare05@gmail.com	Sambare
Anushka S. Wele	8530778433	anushkawele@gmail.com	Wele
Bhumnika D. Chedge	8830391103	bhumnikachedge@gmail.com	Chedge
Vivek R. Waghmare	8956482591	vivekwaghmare18@gmail.com	Waghmare
Anjali R. Pali	7498102109	palianjali446@gmail.com	Pali
Suman A. Singh	7249465307	sumansingh2@gmail.com	Singh
Manish Gade	9370329857	manishgade79@gmail.com	Gade
Shreyansh S. Neikwar	7447844189	shreyanshneikwar7@gmail.com	Neikwar
Shivani Dewvedi	8855900546	shivandewvedi41@gmail.com	Dewvedi
Krushnati S. Kadu	8625854995	krushnatikadu@gmail.com	Kadu
Shweta Pawar	9527988707	shwetipawar8@gmail.com	Pawar
Babraj Wetale	9420396682	babrajwetale@gmail.com	Wetale

Signature of:

Shikha
Programme in-charge

[Signature]

IQAC Coordinator

CO ORDINATOR
INTERNAL QUALITY ASSURANCE CELL
DHARAMPETH M. P. DEO MEMORIAL
SCIENCE COLLEGE, NAGPUR

Principal

Principal
Dharampeth M. P. Deo Memorial
Science College, Nagpur



DHARAMPETH M. P. DEO MEMORIAL SCIENCE COLLEGE,
North Ambazari Road, Near Ambazari Lake, Nagpur- 440033

DATA VALIDATION & VERIFICATION (DVV)

Tanmay. Y. Chaudhari	8600102341	fruchur@rediffmail.com	Yes
Aishwarya Joshi	9498328602	aishwarya.joshi@gmail.com	Yes
Suraj Shyam Yadav	8767435158	surajshyam.yadav@gmail.com	Yes
Sanket Kailash Lode	7972085380	sanketlode123@gmail.com	Yes
Nandini P. Pournikar	9764359642	nandini.pournikar@gmail.com	Yes
Pranjali N. Gadikwad	9130893362	gadikwadpranjali39@gmail.com	Gadikwad
Suhani P. Indurkar	9370419064	suhaniindurkar990@gmail.com	Indurkar

[Handwritten Signature]

Signature of:

[Handwritten Signature]
Programme In-charge

IQAC Coordinator
CO ORDINATOR
INTERNAL QUALITY ASSURANCE CELL
DHARAMPETH, M. P. DEO MEMORIAL &
SCIENCE COLLEGE, NAGPUR

Principal
Principal
Dharampeth M. P. Deo Memorial
Science College Nagpur



DHARAMPETH M. P. DEO MEMORIAL SCIENCE COLLEGE, NAGPUR
INTERNAL QUALITY ASSURANCE CELL (IQAC)

Activity Report

Date: 31/03/2023

Name of Organizing Department or Committee: Computer Science

Name of the activity: NEP Activity

Suggested CRITERION point if any: V

Date of Activity: V

Place of Activity: College Premises (Class Rooms)

Name of Guest Speaker/s or Judge/s or Chief Guest/s if any: NA

Title of the Activity: Poster Making on Virtual Function and Rules of Virtual Function

Number of Participants: 46

Name of the Teacher In-charge / Convener: Mrs. Ruma Kapre

Names of other Committee Members / Staff: NA

OUTCOME of the Activity with respect to mission vision of the institute and or academics:

Through the activity students made beautiful poster on the given topics. Students made group of 4 to 5 and discussed on the topic in group, shares idea of how to make poster on topic and then they made poster in the classrooms. The activity enhances learning, thinking, working in group ability of the students.

Activity with newspaper coverage if any: NA

Activity data save in PC of: Mrs. Ruma Kapre



Prof. Pitambar Humane
IQAC Coordinator

CO ORDINATOR
INTERNAL QUALITY ASSURANCE CELL
DHARAMPETH, M. P. DEO MEMORIAL &
SCIENCE COLLEGE, NAGPUR

Mrs. Ruma Kapre
Name & Signature of Teacher In-charge

Dr. Akhilesh Peshwe
Principal

PRINCIPAL
Dharampeth M.P. Deo Memorial
Science College, Nagpur-440033



DHARAMPETH M. P. DEO MEMORIAL SCIENCE COLLEGE,
North Ambazari Road, Near Ambazari Lake, Nagpur- 440033

DATA VALIDATION & VERIFICATION (DVV)

Name of the Programme : Poster Making on Virtual Functions and Rules of
Date of the Programme : 31/03/2023 Virtual Functions [sem II, Unit
Name of Chief Guest if any : NA IV NEP Activity
Name of Guest Speaker if any : NA

Sr. No.	Name of the Participant	Mobile Number	E-mail Id	Signature
1]	Rutika Yadav	8446085943	yadavrutika434@gmail.com	Rutika
2]	Vausha Tukkar	9873650950	vaushatukkar42@gmail.com	Tukkar
3]	Tanvi Laibey	8446510539	Tanvilaibey@gmail.com	Laibey
4]	Sakshi Mishra	9529889315	Smishra93683@gmail.com	Smishra
5]	Tanvi Jage	7385060871	Tanvijage08@gmail.com	Tanvi
6]	Veena Borikar	9322016921	veenaborikar19@gmail.com	veena
7]	Vaidhvee B. Gangol	7507907278	gangolvaidhvee@gmail.com	Gangol
8]	Sonia Niwal	7058425021	niwalsonia70@gmail.com	Sonia
9]	Devashi Kalkde	9021344265	kalkdedevashi@gmail.com	D.P. Kalkde
10]	Monali N. Shende	7796516257	shendemonali92@gmail.com	Monali

Signature of:

Programme In-charge
Ruma Kapre

IQAC Coordinator

CO ORDINATOR
INTERNAL QUALITY ASSURANCE CELL
DHARAMPETH, M. P. DEO MEMORIAL &
SCIENCE COLLEGE, NAGPUR

Principal
PRINCIPAL

Dharampeth M. P. Deo Memorial
Science College, Nagpur-440033



DHARAMPETH M. P. DEO MEMORIAL SCIENCE COLLEGE,
North Ambazari Road, Near Ambazari Lake, Nagpur- 440033

DATA VALIDATION & VERIFICATION (DVV)

11)	Sandeep Kumar	8001144940	sandeepk.2790@gmail.com
12)	Abhishek R. Singh	8208948103	abhi0882005@gmail.com
13)	Rahul. S. Pandey	8767788703	RP9356521@gmail.com
14)	Manoj. P. Patil	7350450579	manojpatil7350450@gmail.com
15)	Divyani G. Zade	7972403069	divyanizade2005@gmail.com
16)	Samiksha Shendre	7420881158	Samikshashendre08@gmail.com
17)	Vaidehi Nagolkar	9325963446	vaidehinagolkar07@gmail.com
18)	Badal G. Somkuwar	7448247750	badalsomkuwar1@gmail.com
19)	Muskan c. Vaideya	9309773287	muskanvaideya9@gmail.com
20)	Tushar Achare	9075995617	achare_tushar15@gmail.com
21)	Simran Dhimale	7666330683	simrandhimale80@gmail.com
22)	Janu Singh	8806855808	Janusingh6349@gmail.com
23)	Elman. S. Kavn	9028837552	Kavn7817@gmail.com
24)	Bhagyashali D. Newase	7796434177	sakshinewase2017@gmail.com
25)	Chetana Chetna S. Buike	8010342968	buikechetna@gmail.com
26)	Pratibha D. Boreve	9579836818	Pratibhaboreve@gmail.com

Signature of

Programme In-charge

Ruma Kapre

Signature of

CO ORDINATOR

INTERNAL QUALITY ASSURANCE CELL
DHARAMPETH, M. P. DEO MEMORIAL &
SCIENCE COLLEGE, NAGPUR

Signature of

Principal
PRINCIPAL

Dharampeth M. P. Deo Memorial
Science College, Nagpur-440033



DHARAMPETH M. P. DEO MEMORIAL SCIENCE COLLEGE,
North Ambazari Road, Near Ambazari Lake, Nagpur- 440033

DATA VALIDATION & VERIFICATION (DVV)

27)	Aayushi Singh	7498985604	aayushisingsh191@gmail.com	Singh
28)	Kashish K. Bisen	7887886117	kashishbisen05@gmail.com	K. Bisen
29)	Pradnya B. Tarpude	8010362232	pradnyatarpude9145@gmail.com	Tarpude
30)	Janhavi Kiancupure	7058285243	janhvikiancupure@gmail.com	Kiancupure
31)	Utkarsha Ingule	7499159178	utkarshaingule9@gmail.com	Ingule
32)	Samiksha A. Panchbudhe	9763075890	samikshapanchbudhe3630@gmail.com	A. Panchbudhe
33)	Divyani V. Zagade	9022866318	divyanti.zagade@gmail.com	Zagade
34)	Janvi V. Khode	7355066634	Janvikhode092@gmail.com	Khode
35)	Branali V. Gupta	7020069377	799915371@gmail.com	Gupta
36)	Halit Khindkar	8055328357	halitkhindkar2@gmail.com	Khindkar
37)	Vedant A. Unsetkar	9049932753	Unsetkarvedant@gmail.com	Unsetkar
38)	Mahesh D. Parode	9112875119	parodemahesh97@gmail.com	Parode
39)	Tejas Dongal	9322578918	tejas874@gmail.com	Dongal
40)	Priyanshu Singh	9527710380	Priyanshusinghji0012@gmail.com	Singh
41)	Ritik H. Hiraniwar	7498066429	RitikHiraniwar37@gmail.com	Hiraniwar
42)	Ved S. Choudhary	7498572766	vedchoudhary.cs.749@gmail.com	Choudhary

Signature of:

Programme In-charge

Ruma Kapre

IQAC Coordinator
CO ORDINATOR
INTERNAL QUALITY ASSURANCE CELL
DHARAMPETH, M. P. DEO MEMORIAL &
SCIENCE COLLEGE, NAGPUR

Principal
PRINCIPAL
Dharampeth M.P. Deo Memorial
Science College, Nagpur-440033



DHARAMPETH M. P. DEO MEMORIAL SCIENCE COLLEGE, NAGPUR
INTERNAL QUALITY ASSURANCE CELL (IQAC)

Activity Report

Date: 31/03/2023

Name of Organizing Department or Committee: Computer Science

Name of the activity: NEP Activity

Suggested CRITERION point if any: V

Date of Activity: 31/03/2023

Place of Activity: Computer Science Laboratory

Name of Guest Speaker/s or Judge/s or Chief Guest/s if any: NA

Title of the Activity: Problem Solving on Context Free Grammar, CFG

Number of Participants: 17

Name of the Teacher In-charge / Convener: Mrs. Ruma Kapre

Names of other Committee Members / Staff: NA

OUTCOME of the Activity with respect to mission vision of the institute and or academics:

Problem solving activity helps students to develop their flexible knowledge, effective problem-solving skills. Students need to learn the concepts, practice problems and then they are able to solve the problems. Through the activity students first learned concept of CFG, then they go through the problems on CFG, practiced in groups, discussed and then solve the problems individually.

Activity with newspaper coverage if any: NA

Activity data save in PC of: Mrs. Ruma Kapre



Mrs. Ruma Kapre

Name & Signature of Teacher In-charge

Prof. Pitambar Humane
IQAC Coordinator

Dr. Akhilesh Peshwe
Principal

CO ORDINATOR
INTERNAL QUALITY ASSURANCE CELL
DHARAMPETH, M. P. DEO MEMORIAL &
SCIENCE COLLEGE, NAGPUR

PRINCIPAL
Dharampeth M.P. Deo Memorial
Science College, Nagpur-440033



DHARAMPETH M. P. DEO MEMORIAL SCIENCE COLLEGE,
North Ambazari Road, Near Ambazari Lake, Nagpur- 440033

DATA VALIDATION & VERIFICATION (DVV)

Name of the Programme : Problem Solving on Context Free Grammar, CFG
Date of the Programme : 31/03/2023 [Unit III, NEP Activity]
Name of Chief Guest if any : NA
Name of Guest Speaker if any : NA

Sr. No.	Name of the Participant	Mobile Number	E-mail Id	Signature
1)	Tanu S. Mohule	7057844882	tanumohule47@fmail.com	Tanumohule
2)	Sankhya Tukhane	9307133863	SankhyaTukhane@gmail.com	Dam.
3)	Komal M Kumbhare	7620314869	KumbhareKomal94@gmail.com	Komal
4)	Neha J. Bunker	8055477553	nehu002bunker@gmail.com	Neha
5)	Pranay S. Dore	8055292863	pranaydore97@gmail.com	Pranay
6)	Tanmay S. Gadam	7262034396	tanmaygadaml@gmail.com	T.S Gadam
7)	Sahil R. Jivtode	9373414643	sahiljivtode73@gmail.com	Sahil
8)	Pratham M. Sonar	7558464862	Prathamsonar134@gmail.com	Pratham
9)	Abhishek A. Falke	7823835535	abhishekfalke358@gmail.com	Abhishek
10)	Bhavesh R. Maske	798995163	bhaveshmaske2002@gmail.com	Bhavesh M.

Signature of:

Programme In-charge

[Mrs. Ruma Kapre]

IQAC Coordinator

CO ORDINATOR
INTERNAL QUALITY ASSURANCE CELL
DHARAMPETH, M. P. DEO MEMORIAL &
SCIENCE COLLEGE, NAGPUR

Principal
PRINCIPAL

Dharampeth M.P. Deo Memorial
Science College, Nagpur-440033



DHARAMPETH M. P. DEO MEMORIAL SCIENCE COLLEGE, NAGPUR
INTERNAL QUALITY ASSURANCE CELL (IQAC)
Activity Report

Date: 31/03/2023

Name of Organizing Department or Committee: English Department

Name of the activity: Scrap Book Making

Suggested CRITERION point if any: Criteria V

Date of Activity: 31 March 2023

Place of Activity: College

Name of Guest Speaker/s or Judge/s or Chief Guest/s if any: Nil

Title of the Activity: Scrap Book Making (Five Stars of India)

Number of Participants: 67

Name of the Teacher In-charge / Convener: Dr. Mrs. Shraddha Deshpande

Names of other Committee Members / Staff: Dr. Akhilesh Peshwe (Principal)

OUTCOME of the Activity with respect to mission vision of the institute and or academics:

Science students are inspired from innovators who produce new products those are helpful in solving social issues. To motivate the students towards incubation and innovation, this activity helped them to know about more such innovators and take inspiration from them. Five categories which they were supposed to search were: Youth, Women, Rural, University projects and Veterans.

Activity with newspaper coverage if any: Nil

Activity data save in PC of: English Department

Prof. Pitambar Humane
IQAC Coordinator

CO ORDINATOR
INTERNAL QUALITY ASSURANCE CELL
DHARAMPETH, M. P. DEO MEMORIAL &
SCIENCE COLLEGE, NAGPUR

Dr. Mrs. Shraddha Deshpande
Teacher Incharge

Dr. Akhilesh Peshwe
Principal
Principal
Dharampeth M.P. Deo Memorial
Science College, Nagpur.



DHARAMPETH M. P. DEO MEMORIAL SCIENCE COLLEGE,
North Ambazari Road, Near Ambazari Lake, Nagpur- 440033

DATA VALIDATION & VERIFICATION (DVV)

(C.E)

Name of the Programme : Scrap Book (Five Stars of India)
Date of the Programme : Fr 31st March 2023
Name of Chief Guest if any : -
Name of Guest Speaker if any : -

Sr. No.	Name of the Participant	Mobile Number	E-mail Id	Signature
	Yeena Borikar	9322016921	yeenaborikar14@gmail.com	<u>Yeena</u>
	Kashish Bisen	7887886119	Kashishbisen25@gmail.com	<u>K. Bisen</u>
	Divyani V. Zagade	9022866318	divyani2zagade@gmail.com	<u>Divyane</u>
	Pranali V. Gupta	7020069377	29991537@gmail.com	<u>Pranali</u>
	Tanvi V. Khode	7395066834	Tanvikhode892@gmail.com	<u>Tanvi</u>
	Bhagyashali D. Neware	7796434177	sairshineware201@gmail.com	<u>B. Neware</u>
	Pranali R. Debnikar	8767581278	pranali@gmail.com	<u>Pranali</u>
	Pratishtha J. Bhatnagar	9579836818	pratishthabhatnagar@gmail.com	<u>Pratishtha</u>
	Samiksha Panchbude	9763075890	Samikshapanchbude36@gmail.com	<u>Samiksha</u>
	Mehil Khizadekar	8055328367	Mehilkhizadekar@gmail.com	<u>Mehil</u>
	Kalyani R. Sindram	82146530522	Sindramkalyani@gmail.com	<u>Kalyani</u>

Signature of:

Pratishtha
Programme In-charge

[Signature]
IQAC Coordinator
CO-ORDINATOR
INTERNAL QUALITY ASSURANCE CELL
DHARAMPETH, M. P. DEO MEMORIAL &
SCIENCE COLLEGE, NAGPUR

[Signature]
Principal
Principal
Dharampeth M.P. Deo Memorial
Science College, Nagpur.



DHARAMPETH M. P. DEO MEMORIAL SCIENCE COLLEGE,
North Ambazari Road, Near Ambazari Lake, Nagpur- 440033

DATA VALIDATION & VERIFICATION (DVV)

Sandeep Kumar	2081144948	sandeepk27900@gmail.com	
Mahesh .D. Pawde	9112275119	pawdemahesh7@gmail.com	M.Pawde
Aman S Koen	9028837552	koen7817@gmail.com	Aman
Vedant S. Ushetkar	9049932253	Ushetkar.vedant@gmail.com	Ushetkar
Sakshi Mishra	9529889315	smishra989683@gmail.com	S. Mishra
Janhvi Joge	7385060871	Janhvijoge08@gmail.com	Janhvi
Urvasha Tukkar	9373650950	urvashatukkar488@gmail.com	Urvasha
Rutika Yadav	8446085943	yadavrutika934@gmail.com	Rutika
Janhvi Laibey	8466510539	Jhanvilaibey@gmail.com	Janhvi
Ved. S. Chaudhary	7098522766	Vedchaudhary0209@gmail.com	Ved
Gendal .B. Machade	9112142728	nithul machade 2008@gmail.com	Gendal
Priyanshu Singh	9527710380	Priyanshusinghji0012@gmail.com	P. Singh
Vibhanshu Jain	9561232200	VibhanshuJain7@gmail.com	Vibhanshu
Pratik Hirarwar	8329789243	Pratik Hirarwar@gmail.com	Pratik
Ritik H. Hirarwar	7498066424	Ritik Hirarwar37@gmail.com	Hirarwar
Tyag Dargre	9322578918	Tyag84k@gmail.com	Tyag
Vogita K. Bhakre	7801020465	Vogitabhakre022584@gmail.com	Bhakre

Signature of:

[Signature]
Programme In-charge

COORDINATOR
INTERNAL QUALITY ASSURANCE CELL
DHARAMPETH M. P. DEO MEMORIAL &
SCIENCE COLLEGE, NAGPUR

Principal
Dharampeth M.P. Deo Memorial
Science College, Nagpur.



DHARAMPETH M. P. DEO MEMORIAL SCIENCE COLLEGE,
North Ambazari Road, Near Ambazari Lake, Nagpur- 440033

DATA VALIDATION & VERIFICATION (DVV)

TUSHAL ACHARE	9075995617	acharetushal@gmail.com	Tushal
Vineet .M. Singh	7558426949	singhvineet@gmail.com	Vineet
Tyushabh .D. saha	9097300294	tyushabh.saha.2004@gmail.com	Tyushabh
Simran .N. Dhimale	7666330683	simrandhimale80@gmail.com	Dhimale
Ankit R. Patel	9970905638	ankitpatel797275@gmail.com	Ankit
Badal G somkumar	7448247790	badal.somkumar1@gmail.com	Badal
Harshata Warkhede	8263977209	harshatawarkhede@gmail.com	Harshata
Tanu . A. Singh	8806355808	tanusingh163499@gmail.com	Tanu
Tannu A. Vasthi	9322044903	tannuvasthi@gmail.com	Vasthi
Nayushi V. Singh	8459056697	tan.nayushisingh@gmail.com	Nayushi Singh
Vaishnavi N. Torje	8421657943	Vaishnavitorje2004@gmail.com	Torje
Apeksha D. Katangale	7559455794	apekshakatangale26@gmail.com	Katangale
Nayun N. walthare	7841876747	nayunwalthare29@gmail.com	walthare
Aihel V. Meshram	8707792900	nihalmeshram74@gmail.com	Meshram
Neha wanjari	9373832260	nehawanjari133@gmail.com	Neha
Isha I. Waghmare	8855919474	ishawaghmare947@gmail.com	Isha

Signature of:
 Shivam - U. Patel
 Durgesh K. Godmare
 Programme In-charge

Pratibha .B. Bhusari 7821048413 P.bhusari718@gmail.com P.B.B
 Shivam 7038884083 Shivam
 Durgesh Godmare 9075318618 durgeshgodmare001@gmail.com Durgesh
 CO ORDINATOR
 IQAC Coordinator
 Principal

INTERNAL QUALITY ASSURANCE CELL
 DHARAMPETH, M. P. DEO MEMORIAL &
 SCIENCE COLLEGE, NAGPUR

Principal
 Dharampeth M.P. Deo Memorial
 Science College, Nagpur.



DHARAMPETH M. P. DEO MEMORIAL SCIENCE COLLEGE,
North Ambazari Road, Near Ambazari Lake, Nagpur- 440033

DATA VALIDATION & VERIFICATION (DVV)

Tejas R. Chelmevar	9604662119	tejaschelmevar@gmail.com	<i>[Signature]</i>
Aniket J Bawankar	9707219301	BawankarAniket@gmail.com	<i>[Signature]</i>
Pritham S Rature	8010793204	prithamrature655@gmail.com	<i>[Signature]</i>
Surej M Mishra	9730632023	surej.mishra973063@gmail.com	<i>[Signature]</i>
Pranjali L. Meshram	7888080054	pranjali.l.meshram85@gmail.com	<i>[Signature]</i>
Adya Dhoke	9011681628	adyadhamale1701@gmail.com	<i>[Signature]</i>
Ravindra Khadse	8007198273	khadse.ravindra80071982@gmail.com	<i>[Signature]</i>
Aparna Mohare	7020649887	aparnamohare56@gmail.com	<i>[Signature]</i>
Yogita Denge	7058437240	yogitadenge@gmail.com	<i>[Signature]</i>
Amay Barkar	9188538614	amaybarkar19@gmail.com	<i>[Signature]</i>
Sejal Kolhe	8483045985	kolhesejal01@gmail.com	<i>[Signature]</i>
Anshul Kirnapure	9284067169	anshulkirnapure650@gmail.com	<i>[Signature]</i>
Sanyak Hadke	7020171304	Sanyakhadke30@gmail.com	<i>[Signature]</i>
Vidya F. Lohi	7020963219	vidyalohi8@gmail.com	<i>[Signature]</i>
Sonig Niwal	7058425021	niwalsonig940@gmail.com	<i>[Signature]</i>
Monali Shende	7796516257	shendemonali92@gmail.com	<i>[Signature]</i>

Signature of:

Komalika Chaudhari
Brijanshu Raut
Anjali Thakre
Tannay Tewari

[Signature]
Programme In-charge

IQAC Coordinator

DHARAMPETH, M. P. DEO MEMORIAL &
SCIENCE COLLEGE, NAGPUR

Komalika Chaudhari
Brijanshu Raut
Anjali Thakre
Tannay Tewari

Principal

Principal
Dharampeth M.P. Deo Memorial
Science College, Nagpur.



DHARAMPETH M. P. DEO MEMORIAL SCIENCE COLLEGE, NAGPUR
INTERNAL QUALITY ASSURANCE CELL (IQAC)
Activity Report

Date: 31/03/2023

Name of Organizing Department or Committee: English Department

Name of the activity: Scrap Book Making (Synthesis of Science and Spirituality)

Suggested CRITERION point if any: Criteria V

Date of Activity: 31 March 2023

Place of Activity: College

Name of Guest Speaker/s or Judge/s or Chief Guest/s if any: Nil

Title of the Activity: Scrap Book Making (Synthesis of Science and Spirituality)

Number of Participants: 87

Name of the Teacher In-charge / Convener: Dr. Mrs. Shraddha Deshpande

Names of other Committee Members / Staff: Dr. Akhilesh Peshwe (Principal)

OUTCOME of the Activity with respect mission vision of the institute and or academics:

Students were given a chance to study Synthesis of Science and Spirituality through various parameters such as Relationship between Science and Spirituality, Science and Spirituality and Pandemics Noble Laureates on science and Spirituality, The Union of Science and Spirituality, Science and Spirituality in Modern India.

Activity with newspaper coverage if any: Nil

Activity data save in PC of: English Department

Prof. Pitambar Humane
IQAC Coordinator

CO ORDINATOR
INTERNAL QUALITY ASSURANCE CELL
DHARAMPETH, M. P. DEO MEMORIAL &
SCIENCE COLLEGE, NAGPUR

Dr. Mrs. Shraddha Deshpande
Teacher Incharge

Dr. Akhilesh Peshwe
Principal
Principal
Dharampeth M.P. Deo Memorial
Science College, Nagpur.



DHARAMPETH M. P. DEO MEMORIAL SCIENCE COLLEGE,
North Ambazari Road, Near Ambazari Lake, Nagpur- 440033

c.E

DATA VALIDATION & VERIFICATION (DVV)

Name of the Programme : Scrap Book (Synthesis of Science & Spirituality)
Date of the Programme : 31st March 2023
Name of Chief Guest if any : -
Name of Guest Speaker if any : -

Sr. No.	Name of the Participant	Mobile Number	E-mail Id	Signature
1.	Divyani V. Zagade	9022866318	divyani.zagade@gmail.com	<u>Zagade</u>
2.	Pranali V. Gupta	7020069377	29991537@gmail.com	<u>Gupta</u>
3.	Janvi V. Khode	735506684	Janvi/khode89@gmail.com	<u>Khode</u>
4.	Pratiksha J. Baware	9579836818	Pratikshabaware49@gmail.com	<u>Baware</u>
5.	Bhagyashali S. Dewate	1196434177	Sakshidewate2017@gmail.com	<u>B. Dewate</u>
6.	Pranali R. Dehmuker	8767581278	Paleha@gmail.com	<u>Pranali</u>
7.	Kashish K. Bisen	7887886117	Kashishbisen@gmail.com	<u>K. Bisen</u>
8.	Samiksha Panchbudhe	9763075890	Samiksha.panchbudhe363@gmail.com	<u>S. Panchbudhe</u>
9.	Sandeep Kumar	8081144948	Sandeepk21900@gmail.com	<u>Sandeep</u>
10.	Vedant S. Unethkar	9049932753	Unethkar.vedant@gmail.com	<u>Unethkar</u>

Signature of:

[Signature]
Programme In-charge

[Signature]
IQAC Coordinator
INTERNAL QUALITY ASSURANCE CELL
DHARAMPETH, M. P. DEO MEMORIAL &
SCIENCE COLLEGE, NAGPUR

[Signature]
Principal
Dharampeth M.P. Deo Memorial
Science College, Nagpur.



DHARAMPETH M. P. DEO MEMORIAL SCIENCE COLLEGE,
North Ambazari Road, Near Ambazari Lake, Nagpur- 440033

DATA VALIDATION & VERIFICATION (DVV)

	Yeena Boykar	9322016921	yeenaboykar4@gmail.com	<u>Yeena</u>
	Sakshi Mishra	9829889315	Smishra39683@gmail.com	<u>Smishra</u>
	Mahit Khedkar	8055328357	mdhilkhedkar@gmail.com	<u>Mahit</u>
	Vrusha Turkar	9373650950	Vrushaturkar28@gmail.com	<u>Vrusha</u>
	Janhvi Jage	7385060871	Janhvijage08@gmail.com	<u>Janhvi</u>
	Mahesh Pawde	9112875119	pawdemahesh97@gmail.com	<u>Mahesh</u>
	Gendal B. Machade	44091242725	nikhilmachade2005@gmail.com	<u>Gendal</u>
	Tegar Dongre	9322578918	Tegardongre@gmail.com	<u>Tegar</u>
	Priyanshu Singh	9527710380	Priyanshusingh10012@gmail.com	<u>Priyanshu</u>
	Vibhanshu Tane	8561232204	vibhanshutane7@gmail.com	<u>Vibhanshu</u>
	Rudika Yadav	8446085943	yadavrudika434@gmail.com	<u>Rudika</u>
	Janhvi Laitay	8446510539	Jhanvilitay@gmail.com	<u>Janhvi</u>
	Aman S. Kark	9028837552	kark7817@gmail.com	<u>Aman</u>
	Ved. S. Chaudhary	7498522266	vedchaudhary.rs.203@gmail.com	<u>Ved</u>
	Rutik M. Hiranwar	7458066424	RutikHiranwar37@gmail.com	<u>Hiranwar</u>

Signature of:

Suresh Pawde
Programme In-charge

[Signature]
CQAC Coordinator
INTERNAL QUALITY ASSURANCE CELL
DHARAMPETH, M. P. DEO MEMORIAL &
SCIENCE COLLEGE, NAGPUR

[Signature]
Principal
Dharampeth M.P. Deo Memorial
Science College, Nagpur.



DHARAMPETH M. P. DEO MEMORIAL SCIENCE COLLEGE,
North Ambazari Road, Near Ambazari Lake, Nagpur- 440033

DATA VALIDATION & VERIFICATION (DVV)

Tushar Achare	9079995617	achare.tushar@gmail.com	Tushar
Vineet M. Singh	755 8426949	vinet@gmail.com	Vineet
Ankit Patel	7972359646	ankitpatel797235@gmail.com	Ankit
Simran N. Dhimale	7666330683	simrandhimale80@gmail.com	Dhimale
Trushabh D. Saha	8087300294	trushabh.saha.2004@gmail.com	Saha
Tanu A. Singh	8806355808	Tanusingh63492@gmail.com	Tanu
Tannu A. Vaidhi	9322044903	tannuvaidhi@gmail.com	Ruakhis
Aayushi V. Singh	8459056697	Aayushisingh@gmail.com	Aayushisingh
Harshata Warkhede	8263977208	harshata.warkhede@gmail.com	Warkhede
Badal G. Somkumar	7448247750	badal.somkumar2@gmail.com	Badal
Nayana N. Walthare	7541870947	nayanawalthare29@gmail.com	Walthare
Apeksha D. Ketangale	7559455794	apekshaketangale.26@gmail.com	Ketangale
Vaishnavi N. Torne	8421657943	Vaishnavitorne2004@gmail.com	Torne
Bhram S. Rature	8010793204	bhramrature655@gmail.com	Rature
Suraj M. Mishra	9730639023	munna.mishra97306@gmail.com	Mishra

Signature of:

Programme In-charge

IQAC Coordinator
CO-ORDINATOR
INTERNAL QUALITY ASSURANCE CELL
DHARAMPETH, M. P. DEO MEMORIAL &
SCIENCE COLLEGE, NAGPUR

Principal
Principal
Dharampeth M.P. Deo Memorial
Science College, Nagpur.



DHARAMPETH M. P. DEO MEMORIAL SCIENCE COLLEGE,
North Ambazari Road, Near Ambazari Lake, Nagpur- 440033

DATA VALIDATION & VERIFICATION (DVV)

Tejas R Chetmelwale	9600662119	tejaschetmelwale@gmail.com	Tejas
Ushal V. Meshram	8767792960	ushalmeshram74@gmail.com	Ushal
Ishavaghmare	8855919474	ishavaghmare9474@gmail.com	Ishal
Pranjali L. Meshram	7888080054	Pranjalmeshram85@gmail.com	P.L. Meshram
Aniket J Bawankar	9767219301	BawankarAniket56@gmail.com	Aniket
Ravindra Khadse	8007198273	khadseRavindra892@gmail.com	Ravindra
Arya Phoke	8080851619	aryanamrata1937@gmail.com	Arya
Samyak Hadke	7020711304	Samyakhadke@gmail.com	Samyak
Sejal Kolhe	8483045985	KolheSejal09@gmail.com	Sejal
Amay Barik	9168538615	amaybarik219@gmail.com	Amay
Vidya E. Lohi	7020963219	Vidyalohi8@gmail.com	Vidya
Sonia Niwal	7058425021	niwalsonia70@gmail.com	Sonia
Komalika Chaudhari	9322033866	Komalikachaudhari@gmail.com	Komalika
Priyanshu Raut	9322725233	priyanshura@gmail.com	Priyanshu
Anjali R. Thakre	7066554821	thakreanjur@gmail.com	Anjali
Monali Shende	7790516257	shendemonali72@gmail.com	Monali

Signature of:

Programme In-charge

CO-ORDINATOR
IQAC Coordinator
INTERNAL QUALITY ASSURANCE CELL
DHARAMPETH, M. P. DEO MEMORIAL &
SCIENCE COLLEGE, NAGPUR

Principal
Principal
Dharampeth M.P. Deo Memorial
Science College, Nagpur.



DHARAMPETH M. P. DEO MEMORIAL SCIENCE COLLEGE,
North Ambazari Road, Near Ambazari Lake, Nagpur- 440033

DATA VALIDATION & VERIFICATION (DVV)

Pratibha - B. Bhusari	7821048813	pbbhusari718@gmail.com	P.B.P
Shivam - U. Patel	7038889083	sp040263@gmail.com	Shivam
Yogita K. Thakore	7841024443	yogitathakore2584@gmail.com	Y Thakore
Kalyani R. Sindram.	8446539622	Sindramkalyani@gmail.com	K.R. Sindram
Durgesh - K. Ghodmare	9075318618	durgeshghodmare0011@gmail.com	Durgesh
Rudie P. Ruwedi	8090778873	rudiepuwedi30@gmail.com	Rudie P. Ruwedi
Ritika Bhojar	9858709834587087	Ritikbhojar22@gmail.com	Ritika
Monika I. Patel	7499225468	monikapatil032@gmail.com	M. Patel
Megha S. Ballav	9421723380	meghaballav04@gmail.com	M. Ballav
Shital O. Patle	9764596337	SP.12@gmail.com	S. Patle
Kartika .M. Deshmukh	9699720960	KartikaM20@gmail.com	K. Deshmukh
Siddhi .B. Tiwari	8087143696	sidhdhitiwari0721@gmail.com	Siddhi B. Tiwari
Ankasha .k. Khobragade	7972228707	ankashakhobragade7@gmail.com	A. Khobragade
Gunjan . Bhojar	7666799587	gunjanbhojar01@gmail.com	G. Bhojar
R			

Signature of:

Programme In-charge

IQAC Coordinator
INTERNAL QUALITY ASSURANCE CELL
DHARAMPETH, M. P. DEO MEMORIAL &
SCIENCE COLLEGE, NAGPUR

Principal
Dharampeth M.P. Deo Memorial
Science College, Nagpur.



DHARAMPETH M. P. DEO MEMORIAL SCIENCE COLLEGE,
North Ambazari Road, Near Ambazari Lake, Nagpur- 440033

DATA VALIDATION & VERIFICATION (DVV)

Ritika .K. sanduiya	91755 81655	ritikasanduiya@gmail.com	Ritika
Umang .G. Wauthi	9322428500	umanguwathi@gmail.com	Umang
Vaidchi Thoke	7558999131	vaidchithoke22@gmail.com	Vaidchi
Abhishek R Singh	8208948107	abhio882005@gmail.com	Abhishek
Chanchal .K. Waghmare	7796016899	waghmarechanchal@gmail.com	Chanchal
Ashalesha Khadgi	7820929579	AshaleshaKhadgi@gmail.com	Ashalesha
Sunaina Chichonde	8530970132	Sunainachichonde@gmail.com	Sunaina
Khushi Bharti	9664367894	Khushibharti@gmail.com	Khushi
Krutika Pokale	8021533341	pokalekrutika6@gmail.com	Krutika
Lucky A Vishwakarma	9579660186	lvishwakarma34@gmail.com	Lucky
Aakansha Y mairal	8010923662	aakanshamairal@gmail.com	Aakansha
Rally .K. Wanjari	932603213	Rallykwanjari1234@gmail.com	Rally
Geeta R. Bhojare	8668335876	geetabhojare34@gmail.com	Geeta
Dhanashree Neware	9359909913	dhanashreeneware78@gmail.com	Dhanashree
Khushi .K. Rewade	9588445994	Khushirewade@gmail.com	Khushi

Signature of:

Programme In-charge

CO ORDINATOR
INTERNAL QUALITY ASSURANCE CELL
DHARAMPETH, M. P. DEO MEMORIAL &
SCIENCE COLLEGE, NAGPUR

Principal
Dharampeth M.P. Deo Memorial
Science College, Nagpur.



DHARAMPETH M. P. DEO MEMORIAL SCIENCE COLLEGE, NAGPUR
INTERNAL QUALITY ASSURANCE CELL (IQAC)
Activity Report

Date: 31/03/2023

Name of Organizing Department or Committee: English Department

Name of the activity: Story Writing Activity

Suggested CRITERION point if any: Criteria V

Date of Activity: 31 March 2023

Place of Activity: College

Name of Guest Speaker/s or Judge/s or Chief Guest/s if any: Nil

Title of the Activity: Story Writing Activity

Number of Participants: 25

Name of the Teacher In-charge / Convener: Dr. Mrs. Shraddha Deshpande

Names of other Committee Members / Staff: Dr. Akhilesh Peshwe (Principal)

OUTCOME of the Activity with respect to mission vision of the institute and or academics:

Story-writing is a useful art that delights the younger generation. It is a form of composition that is at once instructive and interesting. The art of writing a good short story comes from practice. To develop a logical thinking approach to story writing this activity was undertaken.

Activity with newspaper coverage if any: Nil

Activity data save in PC of: English Department

Prof. Pitambar Humane
IQAC Coordinator

CO ORDINATOR
INTERNAL QUALITY ASSURANCE CELL
DHARAMPETH, M. P. DEO MEMORIAL &
SCIENCE COLLEGE, NAGPUR

Dr. Mrs. Shraddha Deshpande
Teacher Incharge

Dr. Akhilesh Peshwe
Principal
Principal
Dharampeth M.P. Deo Memorial
Science College, Nagpur.



DHARAMPETH M. P. DEO MEMORIAL SCIENCE COLLEGE,
North Ambazari Road, Near Ambazari Lake, Nagpur- 440033

DATA VALIDATION & VERIFICATION (DVV)

(S.E)

Name of the Programme : Story Writing & Report Writing
Date of the Programme : 31st March 2023
Name of Chief Guest if any : -
Name of Guest Speaker if any : -

Sr. No.	Name of the Participant	Mobile Number	E-mail Id	Signature
	Kashish Bisen	7887886117	kashishbisen05@gmail.com	K. Bisen
	Ved. S. Choudhary	7498572766	vedchoudhary.cs.7@gmail.com	Ved
	Samikshapanchbude	9763075890	samikshapanchbude36@gmail.com	Samikshapanchbude
	Mahesh D. Pawde	9112875119	pawdemahesh978@gmail.com	M. Pawde
	Bramali R. Dehomkar	8767581278	Palehara@gmail.com	Bramali R. D.
	Gendal B. Machade	9112142728	nibhimachade2005@gmail.com	Gendal
	Rutika Yadav	8446085933	yadavarutika934@gmail.com	Rutika
	Jhanvi Laibey	8440510539	Jhanvilaibey@gmail.com	Jhanvi
	Aman S. Koen	9028837552	koen7817@gmail.com	Aman
	Pratik Nizamwale	8924788243	pratiknizamwale@gmail.com	Pratik

Signature of:

Programme In-charge

COORDINATOR
INTERNAL QUALITY ASSURANCE CELL
DHARAMPETH, M. P. DEO MEMORIAL &
SCIENCE COLLEGE, NAGPUR

Principal
Dharampeth M.P. Deo Memorial
Science College, Nagpur.



DHARAMPETH M. P. DEO MEMORIAL SCIENCE COLLEGE,
North Ambazari Road, Near Ambazari Lake, Nagpur- 440033

DATA VALIDATION & VERIFICATION (DVV)

Ritik Hiranwar	7498066424	Ritikhiranwar97@gmail.com	Hiranwar
Simran .N. Bhimale	7666380683	simrandhimale30@gmail.com	Bhimale
Vineet .M. Singh	7553426949	singvineet@gmail.com	Singh
Ankit patel	9970905638	ankitpatel797275@gmail.com	Patel
Apeksha D. Kotangale	7559455794	apekshakotangale.26@gmail.com	Kotangale
Nihal V. Meshram	9707792960	nihal.v.meshram74@gmail.com	Mesheram
Vidya E. Lohi	7620963219	Vidyalohi8@gmail.com	Lohi
Sonia Niwal	9058425021	niwalsonia970@gmail.com	Niwal
Anya Dhoke	901681628	anyanamrate.1331@gmail.com	Dhoke
Anvay Borkar	9168538614	anvayborkar19@gmail.com	Borkar
Shivam U. Patel	7038889083	sp040263@gmail.com	Shivam
Megha S. Ballav	9421728880	megha ballav@gmail.com	Ballav
Kartika .M. Deshmukh	4699720960	kartikamid20@gmail.com	Deshmukh
Piddhi B. Jiwani	8087143696	piddhitiwani0721@gmail.com	Jiwani
Vaidiki Jhote	7554997191	vaidikihote21@gmail.com	Jhote

Signature of:

Programme In-charge

IQAC COORDINATOR
INTERNAL QUALITY ASSURANCE CELL
DHARAMPETH M. P. DEO MEMORIAL
SCIENCE COLLEGE, NAGPUR

Principal
Dharampeth M.P. Deo Memorial
Science College, Nagpur,



DHARAMPETH M. P. DEO MEMORIAL SCIENCE COLLEGE, NAGPUR
INTERNAL QUALITY ASSURANCE CELL (IQAC)
Activity Report

Date: 31/03/2023

Name of Organizing Department or Committee: English Department

Name of the activity: Advertisement and Letter Writing

Suggested CRITERION point if any: Criteria V

Date of Activity: 31 March 2023

Place of Activity: College

Name of Guest Speaker/s or Judge/s or Chief Guest/s if any: Nil

Title of the Activity: Advertisement and Letter Writing

Number of Participants: 21

Name of the Teacher In-charge / Convener: Dr.Mrs.Shraddha Deshpande

Names of other Committee Members / Staff: Dr.Akhilesh Peshwe (Principal)

OUTCOME of the Activity with respect to mission vision of the institute and or academics:

Home Science students have career opportunities in different sectors such as Health care, Entrepreneurship research, management etc. either in job or in business; they are needed to promote themselves through various mediums of advertisements. This activity helped them to design and make publicity handouts and flyers those will be needed for this endeavour.

Activity with newspaper coverage if any: Nil

Activity data save in PC of: English Department

Prof. Pitambar Humane
IQAC Coordinator

COORDINATOR
INTERNAL QUALITY ASSURANCE CELL
DHARAMPETH, M. P. DEO MEMORIAL &
SCIENCE COLLEGE, NAGPUR

Dr.Mrs. Shraddha Deshpande
Teacher Incharge

Dr. Akhilesh Peshwe
Principal
Principal
Dharampeth M.P. Deo Memorial
Science College, Nagpur.



DHARAMPETH M. P. DEO MEMORIAL SCIENCE COLLEGE,
North Ambazari Road, Near Ambazari Lake, Nagpur- 440033

S.E

DATA VALIDATION & VERIFICATION (DVV)

Name of the Programme : Advertisement & Letter Writing
Date of the Programme : 31/03/2023
Name of Chief Guest if any : -
Name of Guest Speaker if any : -

Sr. No.	Name of the Participant	Mobile Number	E-mail Id	Signature
	Samiksha Panchbudhe	9763075890	samiktshapanchbudhe@gmail.com	S.Panchbudhe
	Kashish K. Bisen	7887886117	Kashishbisen05@gmail.com	K. Bisen
	Ved. S Chaudhary	498572766	vedchadkary.15.200@gmail.com	Ved
	Shimran, N. Ahimale	7666330683	shimrandhimale30@gmail.com	Shimale
	Pramodhi R. Dehamkar	8767581278	Polehna@gmail.com	Pramodhi
	Gendal B. Machade	9172142728	nikhil machade 2005@gmail.com	Gendal
	Mahesh D. Pawde	9112875119	pawdemahesh97@gmail.com	Mahesh
	Rutika Yadav	8446085943	yadavrutika934@gmail.com	Rutika
	Jinhvi Laibey	8446510539	Jinhvilaibey@gmail.com	Jinhvi
	Aman S. Karm	9028838552	karm787@gmail.com	Aman

Signature of:
Sandhya Pawde
Programme In-charge

COORDINATOR
INTERNAL QUALITY ASSURANCE CELL
DHARAMPETH, M. P. DEO MEMORIAL &
SCIENCE COLLEGE, NAGPUR

[Signature]
Principal
Dharampeth M.P. Deo Memorial
Science College, Nagpur.



DHARAMPETH M. P. DEO MEMORIAL SCIENCE COLLEGE,
North Ambazari Road, Near Ambazari Lake, Nagpur- 440033

DATA VALIDATION & VERIFICATION (DVV)

Pratik H. Hiranwar	8329789243	Pratik.Hiranwar@gmail.com Pratik
Pratik H. Hiranwar	7998066424	Pratik.Hiranwar37@gmail.com Hiranwar
Vineet Singh	7558426949	Singh Vineet 7558426949@gmail.com
Ankit patel	9970905638	ankit patel 797275@gmail.com
Apeksha D. Kotangale	7559455794	apekshakotangale26@gmail.com A Kotangale
whal V. Meshram	8767792960	whalmeshram70@gmail.com whal
Vidya F. Lohi	7020963219	Vidyalohi8@gmail.com V
Soni Nihal	7058425021	niwalsoni940@gmail.com soniwal
Arya Dhoke	9011681628	aryamamratak1337@gmail.com Arya
Anvay borkar	9168539614	anvayborkar19@gmail.com Anvay
Shivam U. Patel	7038889083	sp040263@gmail.com Shivam
Megha S. Ballav	9421728380	meghaballav01@gmail.com Megha
Kartika M. Deshmukh	9609720960	Kartika.m.d.20@gmail.com Kartika
esidolki B. Tiwari	8081143696	esidolkitiwari0721@gmail.com esidolki
Vaideshi Jhote	7558499191	vaideshijhote27@gmail.com Vaideshi
/		

Signature of:

Programme In-charge

ICAAC COORDINATOR
INTERNAL QUALITY ASSURANCE CELL
DHARAMPETH, M. P. DEO MEMORIAL &
SCIENCE COLLEGE, NAGPUR

Principal
Dharampeth M.P. Deo Memorial
Science College, Nagpur.



**DHARAMPETH M. P. DEO MEMORIAL SCIENCE COLLEGE, NAGPUR
INTERNAL QUALITY ASSURANCE CELL (IQAC)**

Activity Report

Date: 31st March., 2023

Name of Organizing Department or Committee: BOTANY DEPARTMENT

Name of the activity: Ethno-medicinal Plants

Suggested CRITERION point if any: CRITERION-I

Date of Activity: 31st March, 2023

Place of Activity: DHARAMPETH M.P. DEO MEMORIAL SCIENCE COLLEGE

Name of Guest Speaker/s or Judge/s or Chief Guest/s if any: Dr. Mrs. Sweta Rai

Title of the Activity: To Study five Ethnomedicinal Plants used by local people

Number of Participants: 36

Name of the Teacher In-charge / Convener: Dr. Mrs. Reshma Hiwase

Names of other Committee Members / Staff: Dr. Chandrakumar Patle, Mr. Amol Pimpalshende, Dr. Mrs. Sweta Rai & Mrs. Dipali Nikure

OUTCOME of the Activity with respect to mission vision of the institute and or academics:

The outcome of using local people's ethnomedicinal plants can be quite beneficial for promoting traditional medicine practices and improving access to healthcare in local communities. Students documented data on medicinal plants and understood the role of ethnic people in traditional medicine.

Activity with newspaper coverage if any: NA

Activity data save in PC of: Reshma Hiwase's Laptop



**Prof. Pitambar Humane
IQAC Coordinator**

**INTERNAL QUALITY ASSURANCE CELL
DHARAMPETH M. P. DEO MEMORIAL &
SCIENCE COLLEGE, NAGPUR**

Name & Signature of Teacher In-charge

Dr. Reshma Hiwase

Dr. Akhilesh Peshwe

Principal

**Dharampeth M.P. Deo Memorial
Science College, Nagpur.**



DHARAMPETH M. P. DEO MEMORIAL SCIENCE COLLEGE,
North Ambazari Road, Near Ambazari Lake, Nagpur- 440033

DATA VALIDATION & VERIFICATION (DVV)

Name of the Programme : To study ethnomedicinal plants
Date of the Programme : 31.03.2023
Name of Chief Guest if any : _____
Name of Guest Speaker if any : _____

Sr. No.	Name of the Participant	Mobile Number	E-mail Id	Signature
1.	Anushri. Shrikant. Wele	8530778433	anushriwele@gmail.com	
2.	Anjali R. Pali	7498102109	paliyanjali446@gmail.com	
3.	Vaishnavi R Chandekar	7249882964	VaishnaviChandekar@gmail.com	
4.	Sayli S. Lokhande	9356413804	sayli.lokhande2910@gmail.com	
5.	Shraddha Bhagat	7558367348	shardabhagat55@gmail.com	
6.	Bhumika D. chedge	8830391103	bhumikachedge@gmail.com	
7.	Vivek R. Wadhwagh	8956482591	vivekwadhwagh89@gmail.com	
8.	Vanshika. C. Yede	7558244609	vanshikayede1@gmail.com	
9.	Kaustubh. R. Ramteke	7218487714	ramtekekaustubh2002@gmail.com	
10.	Sakshi .V. chamate	7709204893	chamate.sakshi20@gmail.com	
11.	Shubham . P. bhoktrajade	9518788915	Shubhambhoktrajade2001@gmail.com	

Signature of:

Programme In-charge

IQAC Coordinator

Principal

Dharampeth M. P. Deo Memorial
Science College, Nagpur.



DHARAMPETH M. P. DEO MEMORIAL SCIENCE COLLEGE,
North Ambazari Road, Near Ambazari Lake, Nagpur- 440033

DATA VALIDATION & VERIFICATION (DVV)

12	Rinam C Wankhede	8010966529	wankhedeinam07@gmail.com	Wankhede
13	Madhura U. Bhondwe	8767484914	Madhurabhondwe@gmail.com	M Bhondwe
14	Roshani M. Bambal	9325853408	Roshani 2016 bb@gmail.com	Bambal
15	Samiksha R. Choudhary	7517090406	Choudharysamiksha20@gmail.com	Choudhary
16	Ayushi Shukla	9373668043	ayushishukla@gmail.com	Shukla
17	Samiksha N. Kuntekar	9145253758	samikshakuntekar@gmail.com	Kuntekar
18	Prajwal Murgle	9834234902	prajwalmurgle@gmail.com	Murgle
19	Kushali Kade	8625854995	kushalikade407@gmail.com	Kade
20	Shreyansh S. Naitwal	7411844189	shreyanshnaitwal7@gmail.com	Naitwal
21	Sankuuli S. Panichbrau	7447613185	sankuulipanichbrau459@gmail.com	Panichbrau
22	Suman . A. Singh .	7249465307	missumansingh3@gmail.com	Suman
23	Astha A. Sakharwale	9405197842	asthasakharwale@gmail.com	Sakharwale
24	Ajatuwini A. Bhagat	940523642	ajatuwini bhagat@gmail.com	Bhagat
25	Dhanjali L. Dhanu	9325473312	dhanjali dhanu6@gmail.com	Dhanu
26	Avanti chophekar	7875173867	avanti1011@gmail.com	Avanti
27	Saniya . P. Naik	9370570457	saniyanaike51@gmail.com	Naik

Signature of:

Programme In-charge

IQAC Coordinator

Principal
Dharampeth M.P. Deo Memorial
Science College, Nagpur.



DHARAMPETH M. P. DEO MEMORIAL SCIENCE COLLEGE,
North Ambazari Road, Near Ambazari Lake, Nagpur - 440033

DATA VALIDATION & VERIFICATION (DVV)

28	Rani B. Kateale	9011247038	brani8112@gmail.com	Rani
29	Rukhi P. Gedam	7378312504	gedamrukhi2000@gmail.com	Rukhi
30	Neha A. Waghade	7249895144	nehawaghade16082002@gmail.com	NWaghade
31	Meunali R. Somsare	9850163812	Somsaremeunali16@gmail.com	Meunali
32	Sakshi P. Mankar	8180816539	sakshizol8mm@gmail.com	Sankar
33	Jayashree D. Hiwase	7385473157	Juhihiwase1@gmail.com	J.D. Hiwase
34	Aspita T. Dakhale	8010866758	aspitadakhale02@gmail.com	Dakhale
35	Asha S. Landge	932231551	ashalandge0501@gmail.com	Ash. S. Landge
36	Neha R. Khorewase	8766738340	nehar2002.kk@gmail.com	Khorewase

Signature of:

Programme In-charge

IQAC Coordinator

Principal
Dharampeth M. P. Deo Memorial



DHARAMPETH M. P. DEO MEMORIAL SCIENCE COLLEGE, NAGPUR
INTERNAL QUALITY ASSURANCE CELL (IQAC)
Activity Report

Date: 31st March., 2023

Name of Organizing Department or Committee: BOTANY DEPARTMENT

Name of the activity: POSTER COMPETITION

Suggested CRITERION point if any: CRITERION-I

Date of Activity: 31st March, 2023

Place of Activity: DHARAMPETH M.P. DEO MEMORIAL SCIENCE COLLEGE

Name of Guest Speaker/s or Judge/s or Chief Guest/s if any: Dr. Mrs. Sweta Rai

Title of the Activity: To study Poster competition on microscopy and techniques

Number of Participants: 35

Name of the Teacher In-charge / Convener: Dr. Mrs. Reshma Hiwase

Names of other Committee Members / Staff: Dr. Chandrakumar Patle, Mr. Amol Pimpalshende, Dr. Mrs. Sweta Rai & Mrs. Dipali Nikure

OUTCOME of the Activity with respect to mission vision of the institute and or academics:
Students understood the techniques of microscopy by this activity. Students also knew the various types of microscopes as well as their function to observe the various types of organisms as well micro entities.

Activity with newspaper coverage if any: NA

Activity data save in PC of: Reshma Hiwase's Laptop



Prof. Pitambar Humane
IQAC Coordinator

CO COORDINATOR
INTERNAL QUALITY ASSURANCE CELL,
DHARAMPETH M. P. DEO MEMORIAL &
SCIENCE COLLEGE, NAGPUR

Name & Signature of Teacher In-charge

Dr. Reshma Hiwase

Dr. Akhilesh Peshwe
Principal

Dharampeth M.P. Deo Memorial
Science College, Nagpur.



DHARAMPETH M. P. DEO MEMORIAL SCIENCE COLLEGE,
North Ambazari Road, Near Ambazari Lake, Nagpur- 440033

DATA VALIDATION & VERIFICATION (DVV)

Name of the Programme : Poster competition on microscopy and techniques
Date of the Programme : 31.03.2023
Name of Chief Guest if any : _____
Name of Guest Speaker if any : _____

Sr. No.	Name of the Participant	Mobile Number	E-mail Id	Signature
1.	Vaishnavi R. Chandekar	7249882964	vaishuchandekar@gmail.com	<u>Chandekar</u>
2.	Sayli S. Lokhande	9356413804	sayalilokhande2910@gmail.com	<u>Lokhande</u>
3.	Ajali R. Pall	7498102109	palianjali446@gmail.com	<u>Pall</u>
4.	Anushri. Shrikant. Wele	8530778433	anushriwele@gmail.com	<u>Wele</u>
5.	Shardabhaagat	7558367398	shardabhaagat456@gmail.com	<u>Bhaagat</u>
6.	Sakshi .v. Chamate	7709204933	chamate.sakshiv@gmail.com	<u>Sakshi</u>
7.	Shubham .P. Khobragade	9518788915	shubhamkhorbragade2001@gmail.com	<u>Shubham</u>
8.	Vanshika. C. Yede	7558244609	vanshikayede1@gmail.com	<u>Yede</u>
9.	Kaustubh. R. Ramteke	7218487714	ramteke.kaustubh2002@gmail.com	<u>Ramteke</u>
10.	Bhumika D. chedge	8830391103	bhumikachedge@gmail.com	<u>Chedge</u>
11.	Vivek R. Mahurwagh	8956082591	vivek000mahurwagh89@gmail.com	<u>Mahurwagh</u>

Signature of:

Phinast

Programme In-charge

IQAC Coordinator

Principal

Dharampeth M. P. Deo Memorial
Science College, Nagpur.



DHARAMPETH M. P. DEO MEMORIAL SCIENCE COLLEGE,
North Ambazari Road, Near Ambazari Lake, Nagpur- 440033

DATA VALIDATION & VERIFICATION (DVV)

12	Rinam C Wankhede	8010966529	wankhedeirinamof@gmail.com	Rinam C Wankhede
13	Madhura U. Bhondure	8767484914	madhuraubondure@gmail.com	M. Bhondure
14	Kashari M. Bhatnagar	9325853408	30/08/2018 66 @ gmail.com	M. Bhatnagar
15	Prajwal Mungle	9834234902	prajwalmungle23@gmail.com	Prajwal Mungle
16	Krushnali Kadu	8625854995	krushnali kadu67@gmail.com	Krushnali Kadu
17	Sanskriti S. Panichbhai	7447613185	sanskritipaniichbhai@gmail.com	Sanskriti S. Panichbhai
18	Shreyansh S. Naikwale	7447544189	shreyanshnaikwale@gmail.com	Shreyansh S. Naikwale
19	Ayushi Shukla	9373668043	ayushishukla78112002@gmail.com	Ayushi Shukla
20	Samiksha N. Kondekar	9145253758	Samikshakondekar@gmail.com	Samiksha N. Kondekar
21	Suman. A. Singh.	7249465307	missumansingh3@gmail.com	Suman. A. Singh.
22	Poojai U. Dandekar	9325473318	dandekarjayali6@gmail.com	Poojai U. Dandekar
23	Attha A. Sakharwade	9405197842	atthasakharwade@gmail.com	Attha A. Sakharwade
24	Avanti A. Chaphekar	7875173847	avanti1011@gmail.com	Avanti A. Chaphekar
25	Swiksha R. Choudhary	7517090406	choudharyswiksha26@gmail.com	Swiksha R. Choudhary
26	Saniya P. Naik	9370570457	saniyanaiks1@gmail.com	Saniya P. Naik
27	Rakhi P. Gudem	7378312504	gedumrathiz2000@gmail.com	Rakhi P. Gudem

Signature of:

Programme In-charge

IQAC Coordinator

Principal

Dharampeth M. P. Deo Memorial
Science College, Nagpur



DHARAMPETH M. P. DEO MEMORIAL SCIENCE COLLEGE, NAGPUR
INTERNAL QUALITY ASSURANCE CELL (IQAC)

Activity Report

Date: 31st March., 2023

Name of Organizing Department or Committee: BOTANY DEPARTMENT

Name of the activity: Drug yielding wild plants

Suggested CRITERION point if any: CRITERION-I

Date of Activity: 31st March, 2023

Place of Activity: DHARAMPETH M.P. DEO MEMORIAL SCIENCE COLLEGE

Name of Guest Speaker/s or Judge/s or Chief Guest/s if any: Dr. Mrs. Sweta Rai

Title of the Activity: To study drug yielding wild plants

Number of Participants:36

Name of the Teacher In-charge / Convener: Dr. Mrs. Reshma Hiwase

Names of other Committee Members / Staff: Dr.Chandrakumar Patle, Mr. Amol Pimpalshende, Dr. Mrs. Sweta Rai & Mrs. Dipali Nikure

OUTCOME of the Activity with respect to mission vision of the institute and or academics:

All over the world there are several thousand drug yielding wild plants. Most of the drug is obtained from wild plants. The medicinal values are high, which produces specific physiological effect on human body. Students searched various wild plants like *Datura stramonium*, *Vinca rosea*, *Plantago* (Isapgol), *Linum usitatissimum* (Flax seed), and *Zingiber officinale* (ginger).

Activity with newspaper coverage if any:NA

Activity data save in PC of: Reshma Hiwase's Laptop



Prof. Pitambar Humane
IQAC Coordinator

CO ORDINATOR
INTERNAL QUALITY ASSURANCE CELL
DHARAMPETH, M. P. DEO MEMORIAL &
SCIENCE COLLEGE, NAGPUR

Name &Signature of Teacher In-charge

Dr. Akhilesh Peshwe

Principal
Dharampeth M.P. Deo Memorial
Science College, Nagpur.



DHARAMPETH M. P. DEO MEMORIAL SCIENCE COLLEGE,
North Ambazari Road, Near Ambazari Lake, Nagpur- 440033

DATA VALIDATION & VERIFICATION (DVV)

Name of the Programme

: To study drug yielding wild plants

Date of the Programme

: 31.03.2023

Name of Chief Guest if any

: _____

Name of Guest Speaker if any

: _____

Sr. No.	Name of the Participant	Mobile Number	E-mail Id	Signature
1.	Shubham P. Khobragade	9518788915	shubhamkhobragade2001@gmail.com	
2.	Vanshika C. Yede	7558244609	vanshikayede1@gmail.com	
3.	Sakshi V. Chamate	7709 20 69 33	chamate.sakshi2@gmail.com	
4.	Kaustubh R. Ramteke	7218487714	ramteke.kaustubh2002@gmail.com	
5.	Bhumika D. Chedge	8830391103	bhumikachedge@gmail.com	
6.	Vivek R. Waghmare	8956482591	vivek.waghmare89@gmail.com	
7.	Shantabhi Bhagat	7558367348	shantabhi.bhagat45@gmail.com	
8.	Anjali R. Pali	7498102109	pali.anjali246@gmail.com	
9.	Anushri Shrikant. Wele	8530778433	anushri.wele@gmail.com	
10.	Sayli S. Lokhande	9356413804	Sayali.lokhande2910@gmail.com	

Signature of:

Programme In-charge

IQAC Coordinator

Principal

Dharampeth M. P. Deo Memorial
Science College, Nagpur.



DHARAMPETH M. P. DEO MEMORIAL SCIENCE COLLEGE,
North Ambazari Road, Near Ambazari Lake, Nagpur- 440033

DATA VALIDATION & VERIFICATION (DVV)

11.	Vaishnavi R. Chandekar	7249882964	vaishuchandekar@gmail.com	Chandekar
12.	Rinam C Wankhede	8010966529	wankhede.rinam@gmail.com	Wankhede
13.	Roshani M. Bambal	9325853608	Roshani2018bb@gmail.com	Bambal
14.	Madhura Bhondwe	8767484914	MadhuraBhondwe@gmail.com	Bhondwe
15.	Sauvikha R. Choudhary	7517090406	choudharysauvikha26@gmail.com	Sauvikha
16.	Ayushi Shukla	9373668043	ayushichy2018@gmail.com	Shukla
17.	Samiksha N. Khandekar	9145253758	SamikshaKhandekar@gmail.com	Khandekar
18.	Pragwal Mungle	9834284902	pragwalmungler@gmail.com	Mungle
19.	Krushali Kade	8625854995	KrushaliKade167@gmail.com	Kade
20.	Sankhuti S. Panchbhare	7497613185	sankhutipanchbhare459@gmail.com	Panchbhare
21.	Dhanjani C. Dandale	9525473318	dandaledhanjani@gmail.com	Dandale
22.	Ojaswini Bhasat	9011023649	ojaswini9@gmail.com	Bhasat
23.	Altha Sakhaswade	9405197842	althasakhaswade@gmail.com	Sakhaswade
24.	Avanti Chaphekar	7875173847	avanti1011@gmail.com	Chaphekar
25.	Shreyashi S. Naikwal	7447849189	shreyashinaikwal@gmail.com	Naikwal
26.	Suman, A. Singh,	7249465307	missuman.singh3@gmail.com	Suman
27.	Sanjaya P. Naik	9370570457	sanjayanaik5@gmail.com	Naik

Signature of:

[Signature]

Programme In-charge

[Signature]
IQAC Coordinator

[Signature]
Principal



DHARAMPETH M. P. DEO MEMORIAL SCIENCE COLLEGE,
North Ambazari Road, Near Ambazari Lake, Nagpur- 440033

DATA VALIDATION & VERIFICATION (DVV)

28	Meunali R. Songare	9850163812	Songaremeunali16@gmail.com <u>Meunali</u>
29	Neha. A. Waghade	7249895144	nehawaghade16082002@gmail.com <u>Waghade</u>
30	Rani B. Katuale	9011247028	bksani@120@gmail.com <u>Rani</u>
31	Rukhi. P. Gedam	7378312504	yedarnrukhi2000@gmail.com <u>Gedam</u>
32	Sakshi P. Maukar	8180816537	sakshi2018mmr@gmail.com <u>Maukar</u>
33	Jayashree D. Hiwarkar	7385073157	Jehihiwarkar10@gmail.com <u>J. D. Hiwarkar</u>
34	Aspita. T. Dakhale	8010866758	aspitadakhale2@gmail.com <u>Dakhale</u>
35	Asha. S. Landge	9322231581	ashalandge000@gmail.com <u>Asha. S. Landge</u>
36	Neha R. Phawase	8766738340	neha2002kk@gmail.com <u>Phawase</u>

Signature of:

Programme In-charge

IQAC Coordinator

Principal

Dharampeth M. P. Deo Memorial
Science College, Nagpur.



Activity Report

Date: 31st March., 2023

Name of Organizing Department or committee: BOTANY DEPARTMENT

Name of the activity: POSTER COMPETITION

Suggested CRITERION point if any: CRITERION-I

Date of Activity: 31st March, 2023

Place of Activity: DEPARTMENT OF BOTANY

Name of Guest Speaker/s or Judge/s of Chief Guest/s if any: Prof. Pitambar Humane

Title of the activity: Poster Competition on Cell Organelles.

Number of Participants: 33

Name of the Teacher In-charge/Convener: Dr Chandrakumar Patle

Name of the other committee members / Staff: Dr. Mrs. Reshma Hiwase

OUTCOME of the Activity with respect to mission vision of the institute and or academics:
Poster helps to develop the skills throughout the student's life. Competition really gives students a sense of achievement and pride within themselves. Poster competition provides a boost to their self confidence and self esteem with knowledge of that subject.

Activity with newspaper converge if any: N A

Activity data save in PC of: DEPT OF BOTANY



Chandrakumar Patle
(Dr C K Patle)

Prof. Pitambar Humane
IQAC Coordinator

CO ORDINATOR
INTERNAL QUALITY ASSURANCE CELL
DHARAMPETH M. P. DEO MEMORIAL
SCIENCE COLLEGE, NAGPUR

Name & Signature of Teacher In-charge

Akhillesh Peshwe
Dr. Akhilesh Peshwe
Principal

Dharampeth M.P. Deo Memorial
Science College, Nagpur.



DHARAMPETH M. P. DEO MEMORIAL SCIENCE COLLEGE,
North Ambazari Road, Near Ambazari Lake, Nagpur- 440033

DATA VALIDATION & VERIFICATION (DVV)

Name of the Programme : Poster Competition On cell organelles
Date of the Programme : 31/03/2023
Name of Chief Guest if any : _____
Name of Guest Speaker if any : _____

Sr. No.	Name of the Participant	Mobile Number	E-mail Id	Signature
1.	Vaibhav A. Malewar	8767838219	vaibhavamalewar79@gmail.com	
2.	Vaishnavi T. Kapse	8983751089	vaishnavikapse05@gmail.com	
3.	Shital G. Bankar	7758055139	shitalbankar122@gmail.com	
4.	Suzett Longudje	8390516517	suzettlongudje@gmail.com	
5.	Kalyani Shahare	9307046378	shahare.kalpani5@gmail.com	
6.	Muskan Yadav	9579492617	muskanyadav1225@gmail.com	
7.	Rhushabu H. Choudhari	7282074960	rhushabuchoudhari88@gmail.com	
8.	Devashri D. Bisen	7773980643	DKBisen74@gmail.com	
9.	Janavi N. Rathod	7263819173	Janavirathodk@gmail.com	
10.	Avesh S. Longudje	9326246453	Aveshlongudje@gmail.com	
11.	Maunali S. Ramteke	9146003783	maunaliaramteke08@gmail.com	
12.	Aditya Patil	9028915770	adityapatil202@gmail.com	
13.	Ashlesha Sangale	9503998469	Ashleshasangale94@gmail.com	
14.	Nikhil Raut	9022680159	Rautn6544@gmail.com	

Signature of:
Programme In-charge

COORDINATOR
INTER IQAC Coordinator
DHARAMPETH M. P. DEO MEMORIAL
SCIENCE COLLEGE, NAGPUR

Principal
Dharampeth M.P. Deo Memorial
Science College, Nagpur



DHARAMPETH M. P. DEO MEMORIAL SCIENCE COLLEGE,
North Ambazari Road, Near Ambazari Lake, Nagpur- 440033

DATA VALIDATION & VERIFICATION (DVV)

Sr. No.	Name of the Participant	Mobile Number	E-mail Id	Signature
15	ANUSH A. Kadam	9163013263	ak 28 55 036 @ gmail.com	<i>[Signature]</i>
16	Devashish D. Bisen	7767861231	Devashishbisen31@	<i>[Signature]</i>
17	Abhishale Dabhhekar	8208302902	Abhishalekar@dsic.co	<i>[Signature]</i>
18	Afina Sheikh	8080083981	afinasheikh@ gmail.com	<i>[Signature]</i>
19	Anurag- Chandel	9145631751	anuchandel2001@gmail.com	<i>[Signature]</i>
20	Ketaki Kinfal	9112759066	ketakikinfal12@gmail.com	<i>[Signature]</i>
21	Gauri Raut	9767873447	gaurikauri2003@gmail.com	<i>[Signature]</i>
22	Samiy Ghumde	9359236713	samiyghumde2@gmail.com	<i>[Signature]</i>
23	Aniket Kurade	7741345323	AKurade61@gmail.com	<i>[Signature]</i>
24	Sagar S. Bawane	9975466979	sagrabawane631@gmail.com	<i>[Signature]</i>
25	Yashashree Chande	9769008925	yashashreechande@gmail.com	<i>[Signature]</i>
26	Shikha Yadav	9263881320	shikha.yadav54@gmail	<i>[Signature]</i>
27	Varsha Tiwari	8408097938	varshatiwari7296@gmail	<i>[Signature]</i>
28	Vanshali S. Patle	9322600647	vanshalipatle.156@gmail.com	<i>[Signature]</i>
29	Subbu R. Mishra	9860436418	Subbumishra234@gmail.com	<i>[Signature]</i>
30	Sushma G. Gurnur	9156238747	sushmagurnur@gmail.com	<i>[Signature]</i>
31	Nikita Bhawe	7820812749	nikita bhawe 98@gmail.com	<i>[Signature]</i>
32	Pratiksha S. Naughare	8623033760	Naughare pratiksha 44@gmail.com	<i>[Signature]</i>
33	Ranchal S. Singh	7875537985	Ranchal Singh 23923@gmail.com	<i>[Signature]</i>

Signature of:

Programme In-charge

[Signature]
Chandrakumar Patle

IQAC Coordinator

DHARAMPETH M. P. DEO MEMORIAL SCIENCE COLLEGE, NAGPUR

Principal

Dharampeth M. P. Deo Memorial Science College, Nagpur



DHARAMPETH M. P. DEO MEMORIAL SCIENCE COLLEGE, NAGPUR
INTERNAL QUALITY ASSURANCE CELL (IQAC)

Activity Report

Date: 31st March., 2023

Name of Organizing Department or committee: BOTANY DEPARTMENT

Name of the activity: POSTER COMPETITION

Suggested CRITERION point if any: CRITERION-I

Date of Activity: 31st March, 2023

Place of Activity: DEPARTMENT OF BOTANY

Name of Guest Speaker/s or Judge/s of Chief Guest/s if any: Prof. Pitambar Humane

Title of the activity: Poster Competition on Cell Division

Number of Participants: 33

Name of the Teacher In-charge/Convener: Dr Chandrakumar Patle

Name of the other committee members / Staff: Dr. Mrs. Reshma Hiwase

OUTCOME of the Activity with respect to mission vision of the institute and or academics: Poster helps to develop the skills throughout the student's life. Competition really gives students a sense of achievement and pride within themselves. Poster competition provides a boost to their self confidence and self esteem with knowledge of that subject.

Activity with newspaper converge if any: N A

Activity data save in PC of: BOTANY DEPARTMENT

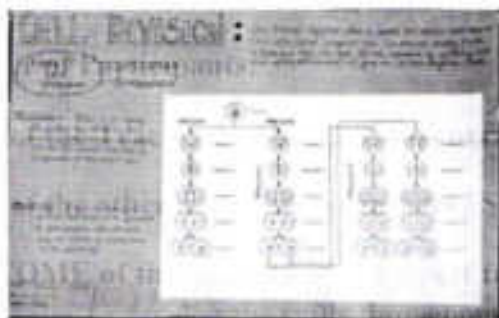

Prof. Pitambar Humane
IQAC Coordinator

CO COORDINATOR
INTERNAL QUALITY ASSURANCE CELL
DHARAMPETH, M. P. DEO MEMORIAL &
SCIENCE COLLEGE, NAGPUR

Name & Signature of Teacher In-charge

Dr. Akhilesh Peshwe
Principal
Dharampeth M.P. Deo Memorial
Science College, Nagpur.



DHARAMPETH M. P. DEO MEMORIAL SCIENCE COLLEGE,
North Ambazari Road, Near Ambazari Lake, Nagpur- 440033

DATA VALIDATION & VERIFICATION (DVV)

Name of the Programme : Postes competition on cell division

Date of the Programme : 31/03/2023

Name of Chief Guest if any : _____

Name of Guest Speaker if any : _____

Sr. No.	Name of the Participant	Mobile Number	E-mail Id	Signature
1.	Shital G. Bankar	9758055139	shitalbankar122@gmail.com	S G Bankar
2.	Vaishnavi T. Kapse	8983751089	vaishnavikapse05@gmail.com	Vaishnavi
3.	Vaibhav A. Malekar	876788219	Vaibhavmalekar19@gmail.com	V. A. Malekar
4.	Suzeti S. Longude	8390516517	suzetilongude10@gmail.com	Suzeti
5.	Rhushabh H. Chaudhari	7262074960	rhushabhchaudhari95@gmail.com	Rhushabh
6.	Muskari Yadav	9579492617	muskariyadav1228@gmail.com	Muskari
7.	Kalyani C. Shahare	9307046378	Shahare Kalyani 5@gmail.com	Kalyani
8.	Janavi N. Raut	7263819173	JanaviRaut2024@gmail.com	Janavi Raut
9.	Deshpriya D. Bisen	7173980643	Deshpriya74@gmail.com	Deshpriya
10.	Deshpriya S. Longude	9326246453	Deshprilongude@gmail.com	Deshpriya
11.	Nikhil R. Raut	9022680159	rautn6541@gmail.com	N Raut
12.	AYUSH A. KADAM	9763013269	ak285505@gmail.com	Ayush
13.	Mounalini S. Ramteke	9146003783	mounalini.s.ramteke28@gmail.com	Mounalini
14.	Devadish D. Bisen	7767861231	Devadishbisen3@gmail.com	Devadish

Signature of:

Programme In-charge

Chandakumar Bhat

IQAC Coordinator

[Signature]
DHARAMPETH M. P. DEO MEMORIAL
SCIENCE COLLEGE, NAGPUR

Principal

[Signature]
DHARAMPETH M. P. DEO MEMORIAL
SCIENCE COLLEGE, NAGPUR



DHARAMPETH M. P. DEO MEMORIAL SCIENCE COLLEGE,
North Ambazari Road, Near Ambazari Lake, Nagpur- 440033

DATA VALIDATION & VERIFICATION (DVV)

Sr. No.	Name of the Participant	Mobile Number	E-mail Id	Signature
15	Aditya Deulka	9028915776	deulkavarditga17@gmail.com	Deulka
16	Ashishkesh Dshbhrade	8208302902	ashishdshbhrade@...	Ashish
17	Abrina Rahim Sheikh	8080083981	abrinashsheikh973@gmail.com	Sheikh
18	Ashlesha Sangale	9503998469	ashleshasangale94@g	Sangale
19	Ketaki Kinkal	9112759066	ketakikinkal12@gmail.com	Kinkal
20	Anushree chandel	9145631751	anuchandel2001@gmail.com	Anandel
21	Chauhan Raut	976188447	ankurhauraut2003@gmail.com	Ch. Raut
22	Somir Ghumde	9359236713	somirghumde2002@gmail.com	Ghumde
23	Aniket Kulkade	9741945323	Aniketkulkade61@gmail.com	Aniket
24	Sagar S. Bawane	9975460979	sagarbawane637@gmail.com	S. Bawane
25	Yashraj P. Chande	916900821	yashrajchande@gmail	Y.P.C
26	Shikha Yadav	7263881320	ShikhaYadav@gmail	S. Yadav
27	Varshali S. Palle	9322600647	varshalipalle56@gmail.com	Palle
28	Sushma Gurnule	9156238747	Sushmagurnule@gmail.com	Gurnule
29	Varsha Tiwari	8408047928	varshatiwari7106@gmail.com	Varsha
30	Subbu Mishra	8860438118	subbumishra234@gmail.com	Subbu
31	Chirayu B. Dolat	8010195012	Chirayudolat22@gmail.com	Dolat
32	Pratiksha S. Naughare	8623033760	NaugharePratiksha@gmail.com	P.S. Naughare
33	Nikita S. Bhawe	7820812719	Nikitabhawe98@gmail.com	Nikita

Signature of:

Programme In-charge

Chandrashekhar

IQAC Coordinator

DHARAMPETH, M. P. DEO MEMORIAL
SCIENCE COLLEGE, NAGPUR

Principal

Dharampeth M. P. Deo Memorial
Science College, Nagpur



DHARAMPETH M. P. DEO MEMORIAL SCIENCE COLLEGE,
North Ambazari Road, Near Ambazari Lake, Nagpur- 440033

DATA VALIDATION & VERIFICATION (DVV)

Sr. No.	Name of the Participant	Mobile Number	E-mail Id	Signature
33	Aanchal S Singh	7875537925	SanchalSingh23923@gmail.com	Aanchal Singh
34				
35				
36				
37				
38				
39				
40				
41				
42				
43				
44				
45				
46				
47				
48				
49				
50				

Signature of:

Programme In-charge

Chandakumar Patil

[Signature]
IQAC Coordinator

DHARAMPETH M. P. DEO MEMORIAL SCIENCE COLLEGE, NAGPUR

[Signature]
Principal

Dharampeth M. P. Deo Memorial Science College, Nagpur.



Activity Report

Date: 31st March., 2023

Name of Organizing Department or committee: BOTANY DEPARTMENT

Name of the activity: SEED DORMANCY

Suggested CRITERION point if any: Criterion-I

Date of Activity: 31st March, 2023

Place of Activity: DEPARTMENT OF BOTANY

Name of Guest Speaker/s or Judge/s of Chief Guest/s if any: Prof. Pitambar Humane, Dr. Mrs. Sweta Rai

Title of the activity: To study dormancy of seeds

Number of Participants:-32

Name of the Teacher In-charge/Convener: Dr Chandrakumar Patle

Name of the other committee members / Staff: Dr. Mrs. Reshma Hiwase, Dr. Mrs. Sweta Rai

OUTCOME of the Activity with respect to mission vision of the institute and or academics: This type of activity encourage and get knowledge about the seed dormancy and how to break seed dormancy. Such as how germination is occur after break down or removal of hard seed coat of seeds. Students knew mechanical scarification, hot water treatment, cold water treatment and acid scarification.

Activity with newspaper converge if any: N A

Activity data save in PC of: BOTANY DEPARTMENT



Prof. Pitambar Humane
IQAC Coordinator

CO ORDINATOR
INTERNAL QUALITY ASSURANCE CELL
DHARAMPETH, M. P. DEO MEMORIAL &
SCIENCE COLLEGE, NAGPUR

Name & Signature of Teacher In-charge

(Dr C K Patle)

Dr. Akhilesh Peshwe
Principal

Dharampeth M.P. Deo Memorial
Science College, Nagpur.



DHARAMPETH M. P. DEO MEMORIAL SCIENCE COLLEGE,
North Ambazari Road, Near Ambazari Lake, Nagpur- 440033

DATA VALIDATION & VERIFICATION (DVV)

Name of the Programme : To study dormancy of seeds
 Date of the Programme : 31/03/2023
 Name of Chief Guest if any : _____
 Name of Guest Speaker if any : _____

Sr. No.	Name of the Participant	Mobile Number	E-mail Id	Signature
1.	Shital G. Bankas	7758055139	shitalbankas122@gmail.com	S G. Bankas
2.	Vaishnavi T. Kapse	8983751089	Vaishnavikapse05@gmail.com	Vaishnavi
3.	Vaibhav A. Malewar	8767838219	Vaibhavmalewar09@gmail.com	Vaibhav
4.	Swati S. Longadje	8390516517	SwatiLongadje11@gmail.com	Swati
5.	Kalyani C. Shahare	9307046378	Shaharekalyani5@gmail.com	Kalyani
6.	Muskan R. Yadav	9579492617	Muskanyadav1225@gmail.com	Muskan
7.	Khushabu H. Choudhary	7262074960	Khushabuchoudhary30@gmail.com	Khushabu
8.	Devashri D. Bisen	7773980643	Devashri74@gmail.com	Devashri
9.	Mummalini S. Ramteke	9146003183	Mummalinaranteke0225@gmail.com	Mummalini
10.	Jaravi N. Rathod	7263819173	Jaravirathod31@gmail.com	Jaravi
11.	Ashlesha Sengole	9503998469	Ashleshasengole94@gmail.com	Ashlesha
12.	Alka Dalke	4028917716	alikalalke17@gmail.com	Alka
13.	Nikhil R. Raut	9022680159	south0541@gmail.com	Nikhil
14.	Ayush A. Kadam	916303263	ak2855036@gmail.com	Ayush

Signature of:

Programme In-charge

Chandrakumar Patil

IQAC Coordinator

DHARAMPETH M. P. DEO MEMORIAL & SCIENCE COLLEGE, NAGPUR

Principal

DHARAMPETH M. P. DEO MEMORIAL Science College, Nagpur.



DHARAMPETH M. P. DEO MEMORIAL SCIENCE COLLEGE,
North Ambazari Road, Near Ambazari Lake, Nagpur- 440033

DATA VALIDATION & VERIFICATION (DVV)

Sr. No.	Name of the Participant	Mobile Number	E-mail Id	Signature
15	Deevanish D. Bisen	7767861231	devanish bisen2016@gmail.com	
16	Abhishale Dashbhatkar	8208302902	abhishaledashbhatkar@gmail.com	
17	Afina sheikh	8080083981	afinasheikh973@gmail.com	
18	Ketaki Kulkarni	911275906	Ketajakulkarni13@gmail.com	
19	Anushree Chandel	9145631751	anuchandel2001@gmail.com	
20	Grauni Raut	9767873447	anuraut2003@gmail.com	
22	Samir Ghumde	9359236713	Sameerghum2002@gmail.com	
22	Aniket Kulkade	7741345323	Akulkade61@gmail.com	
23	Sagar S. Bawane	9975460979	Sagarbawane637@gmail.com	
24	Yashashree P. Charde	9766008929	yashashreecharde@gmail.com	
25	Vaishali S. Patle	9822600647	vaishalipatle176@gmail.com	
26)	Gubbu R. Mishra	9860436478	Gubbumishra230@gmail.com	
27)	Sushma Gangadhar Gurnule	9150238747	Sushmagurnule6@gmail.com	
28)	Shikha Yadav	7263891320	ShikhaYadav@gmail	
29)	Nikita Bhawe	7820812749	nikita bhawe@gmail.com	
30)	Aanchal S. Singh	7875537925	Santoshsingh2392@gmail.com	
31)	Chirayu B. Dolat	8010135012	chirayudolat22@gmail.com	
32)	Pratiksha S. Navghare	8623033760	Navgharepratiksha44@gmail.com	

Signature of:

Programme In-charge

IQAC Coordinator

DHARAMPETH, M. P. DEO MEMORIAL &
SCIENCE COLLEGE, NAGPUR

Principal

Dharampeth M. P. Deo Memorial
Science College, Nagpur



DHARAMPETH M. P. DEO MEMORIAL SCIENCE COLLEGE, NAGPUR
INTERNAL QUALITY ASSURANCE CELL (IQAC)

Activity Report

Date: 31st March., 2023

Name of Organizing Department or committee: BOTANY DEPARTMENT

Name of the activity: HYBRIDIZATION TECHNIQUE

Suggested CRITERION point if any: Criterion-I

Date of Activity: 31st March, 2023

Place of Activity: DEPARTMENT OF BOTANY

Name of Guest Speaker/s or Judge/s of Chief Guest/s if any: Prof. Pitambar Humane

Title of the activity: To study Hybridization in suitable Plants.

Number of Participants:- 32

Name of the Teacher In-charge/Convener: Dr Chandrakumar Patle

Name of the other committee members / Staff: Dr. Mrs. Reshma Hiwase

OUTCOME of the Activity with respect to mission vision of the institute and or academics:

Student knew how to yield hybrid plants by using hybridization techniques. In this activity student understood, emasculation and artificial pollination. They studies hybridization techniques by using two species of Datura (*D. metel* and *D. innoxiana*).

Activity with newspaper converge if any: N A

Activity data save in PC of: BOTANY DEPARTMENT



Prof. Pitambar Humane
IQAC Coordinator
INTERNAL QUALITY ASSURANCE CELL
DHARAMPETH, M. P. DEO MEMORIAL &
SCIENCE COLLEGE, NAGPUR

Name & Signature of Teacher In-charge

Chandrakumar Patle
(Dr. C. K. Patle)

Dr. Akhilesh Peshwe
Principal
Dharampeth M.P. Deo Memorial
Science College, Nagpur.



DHARAMPETH M. P. DEO MEMORIAL SCIENCE COLLEGE,
North Ambazari Road, Near Ambazari Lake, Nagpur- 440033

DATA VALIDATION & VERIFICATION (DVV)

Name of the Programme : To study hybridization in suitable Plants.
 Date of the Programme : 31/03/2023
 Name of Chief Guest if any : _____
 Name of Guest Speaker if any : _____

Sr. No.	Name of the Participant	Mobile Number	E-mail Id	Signature
1.	Valbhava. Malenkar	8767838219	valbhavmalenkar74@gmail.com	
2.	Vaishnavi T. Kapse	8988751089	vaishnavikapse04@gmail.com	
3.	S.G. Bant Shital G. Bankar	7758055139	shital/bankar122@gmail.com	
4.	Saxat. S. Longadje	8390516517	saxatlongadje11@gmail.com	
5.	Kalyani C. Shahase	9307046378	ShahaseKalyani5@gmail.com	
6.	Rhushabu H. Chaudhari	7202074960	Khushabuchaudhari39@gmail.com	
7.	Muskan. R. Yadav.	9579492617	muskan.yadav122@gmail.com	
8.	Janavi. V. Patil	7263519173	JanaviPatil74@gmail.com	
9.	Diksha Bisen	7773980643	DikBisen74@gmail.com	
10.	Mauralini. S. Ramteke	9146003783	mauraliramteke002@gmail.com	
11.	Ashlesha. Deskar	9028415276	deskarashlesha27@gmail.com	
12.	Ashlesha Sangade	9503998469	Ashleshasangade9@gmail.com	
13.	Nikhil. R. Raut	9022080159	rautn05ul@gmail.com	
14.	Ayush A. Kadam	9163013263	ak7855036@gmail.com	

Signature of:

Programme In-charge

IQAC Coordinator

REFERENCE CELL
DHARAMPETH M. P. DEO MEMORIAL &
SCIENCE COLLEGE, NAGPUR

Principal

Dharampeth M.P. Deo Memorial
Science College, Nagpur.



DHARAMPETH M. P. DEO MEMORIAL SCIENCE COLLEGE,
North Ambazari Road, Near Ambazari Lake, Nagpur- 440033

DATA VALIDATION & VERIFICATION (DVV)

Sr. No.	Name of the Participant	Mobile Number	E-mail Id	Signature
15.	Devashish D. Bisen	7767861231	Devashishbisen31@gmail.com	
16	Ashina Sheikh	8080083981	ashinasheikh973@gmail.com	
17	Anushree Chandel	9145631751	anuchandel2001@gmail.com	
18	Chauvi Raut	97673447	ankuraut2003@gmail.com	
19	Ketaki Kizal	9112759066	KetakiKizal13@gmail.com	
20	Samir Ghumde	9359236713	Samirghumde2002@gmail.com	
21	Aniket Kurade	7741995323	AKurade61@gmail.com	
22	Sagar S. Bawane	9975460979	sagarbawane637@gmail.com	
23	Yashraj P. Chardi	9109006921	yashrajchardi@gmail.com	
24	Shikha J. Yadav	7263881320	ShikhaYadav@gmail.com	
25	Subbu R. Mishra	9860436418	Subbumishra23@gmail.com	
26	Sushma G. Gurnule	9156238747	sushmagurnule@gmail.com	
27	Vaishali S. Pathe	9322600647	vaishalipathe1566@gmail.com	
28	Varsha R. Tiwari	8408097938	varshatiwari77@gmail.com	
29	Pratiksha S. Naughare	8623033760	Naugharepratiksha99@gmail.com	
30	Chirayu B. Dolat	8010135012	chirayudolat2@gmail.com	
31	Nikita S. Phave	78782082749	nikitaphave98@gmail.com	
32	Aanchal S. Singh	7875537925	SandeepSingh2323@gmail.com	

Signature of:

Programme In-charge

IQAC Coordinator

DHARAMPETH M. P. DEO MEMORIAL &
SCIENCE COLLEGE, NAGPUR

Principal

Dharampeth M. P. Deo Memorial
Science College, Nagpur.



DHARAMPETH M. P. DEO MEMORIAL SCIENCE COLLEGE, NAGPUR
INTERNAL QUALITY ASSURANCE CELL (IQAC)

Activity Report

Date: 31, March 2023

Name of Organizing Department or Committee: BOTANY DEPARTMENT

Name of the activity: Quiz competition on Biochemistry

Suggested CRITERION point if any: CRITERION-I

Date of Activity: 31st March 2023

Place of Activity: DHARAMPETH M.P. DEO MEMORIAL SCIENCE COLLEGE

Name of Guest Speaker/s or Judge/s or Chief Guest/s if any: Dr. Mrs. Sweta Rai

Title of the Activity: Quiz competition on biochemistry

Number of Participants: 39

Name of the Teacher In-charge / Convener: Prof. Pitambar Humane

Names of other Committee Members / Staff: Dr. Chandrakumar Patle, Mr. Amol Pimpalshende, Dr. Mrs. Reshma Hiwase, Dr. Mrs. Sweta Rai & Mrs. Dipali Nikure

OUTCOME of the Activity with respect to mission vision of the institute and or academics:

This activity creates healthy competition among students and also creates interaction between students and teacher. This competition develops knowledge and make the students to understand biochemistry related topics throughly. This study has developed curiosity and keen interest among students.

Activity with newspaper coverage if any: NA

Activity data save in PC of: Prof. Pitambar Humane's Laptop



CO ORDINATOR
Prof. Pitambar Humane
INTERNAL QUALITY ASSURANCE CELL
DHARAMPETH M.P. DEO MEMORIAL &
SCIENCE COLLEGE, NAGPUR

Name & Signature of Teacher In-charge
Dr. Sweta A. Rai

Dr. Akhilesh Peshwe
Principal

Dharampeth M.P. Deo Memorial
Science College, Nagpur



DHARAMPETH M. P. DEO MEMORIAL SCIENCE COLLEGE,
North Ambazari Road, Near Ambazari Lake, Nagpur- 440033

DATA VALIDATION & VERIFICATION (DVV)

Name of the Programme : Quiz on Biochemistry
Date of the Programme : 31st March 2023
Name of Chief Guest if any : _____
Name of Guest Speaker if any : _____

Sr. No.	Name of the Participant	Mobile Number	E-mail Id	Signature
1.	Vanshika C. Yede	7558244609	vanshikayede2@gmail.com	
2.	Saniya Praveen Naik	9370570457	saniyanair51@gmail.com	
3.	Shubham P. Khobragade	9518785915	shubhamkhobragade2001@gmail.com	
4.	Balraj M. Wadgaonkar	9420396682	balrajwadgaonkar@gmail.com	
5.	Bhumika D. Chedde	8830391103	bhumikachedde@gmail.com	
6.	Vivek R. Wadgaonkar	8956482591	vivekcoohwcoogh89@gmail.com	
7.	Anjali R. Pali	9498102109	palianjali06@gmail.com	
8.	Sakshi V. Chamate	7708204893	chamate.sakshi24@gmail.com	
9.	Sayli S. Lokhande	9356413804	sayalilokhande2910@gmail.com	
10.	Kaustubh R. Ramteke	7218487714	ramtekekaustubh2002@gmail.com	

Signature of

Programme In-charge

CO-ORDINATOR

INTERNAL QUALITY ASSURANCE CELL
IASC COORDINATOR
DHARAMPETH, M. P. DEO MEMORIAL &
SCIENCE COLLEGE, NAGPUR

Principal
Dharampeth M.P. Deo Memorial
Science College, Nagpur.



DHARAMPETH M. P. DEO MEMORIAL SCIENCE COLLEGE,
North Ambazari Road, Near Ambazari Lake, Nagpur- 440033

DATA VALIDATION & VERIFICATION (DVV)

11.	Sakshi .V. chamate	9709104933	chamate.sakshi24@gmail.com	Sakshi
12.	Kaustubh. R. Ramteke	7218487714	ramteke.kaustubh2002@gmail.com	Kaustubh
13.	Shubham .P.khotkhatke	9518788915	shubhamkhotkhatke2001@gmail.com	Shubham
14.	Vanshika. C. Yede	7558244609	vanshikayede1@gmail.com	Yede
15.	Sayli G. Lohande	9356413804	sayalilohande2910@gmail.com	Lohande
16.	Anjali P. Pali	7498102109	palianjali46@gmail.com	Anjali
17.	Bhumika D. chedge	8830891103	bhumikachedge@gmail.com	Chedge
18.	Vivek R. Wadhurwagh	8956482591	vivekwadhurwagh89@gmail.com	Wadhurwagh
19.	Anushri S. Wale	8530778433	anushriwale@gmail.com	Anushri
20.	Samiksha No Kundekar	9145253757	samikshakundekar@gmail.com	Kundekar
21.	Samiksha R. Chaudhari	7517090406	chaudharisamiksha26@gmail.com	Samiksha
22.	Anjali P. Pali	7498102109	palianjali46@gmail.com	Anjali
23.	Roshani M. Bambal	9325853408	roshani2018bb@gmail.com	Bambal
24.	Madhura Bhandare	8767484914	madhurbhandare	Bhandare
25.	Rinam C Wankhede	8010866529	wankhede.rinam2@gmail.com	Wankhede
26.	Prajali L. Dandekar	9325473318	dandekarprajali6@gmail.com	Dandekar

Signature of: 27 Avantika Chaphekar
28 Attha Sakharwale
Programme In-charge

29 9011023645
7875173847
9405192842
o.j.a.bhast7@gmail.com
avantika1011@gmail.com
atthasakharwale

INTERNAL QUALITY ASSURANCE CELL
DHARAMPETH, M. P. DEO MEMORIAL &
SCIENCE COLLEGE, NAGPUR

Principal
Dharampeth M. P. Deo Memorial
Science College, Nagpur.



DHARAMPETH M. P. DEO MEMORIAL SCIENCE COLLEGE,
North Ambazari Road, Near Ambazari Lake, Nagpur- 440033

DATA VALIDATION & VERIFICATION (DVV)

28	Shreyansh S. Naikwal	7447814189	shreyanshnaikwal7@gmail.com	Shreyansh
29	Ayushi Shukla	9373668043	ayushishukla@gmail.com	Ayushi
30	Vaishnavi R. Chandekar	7249882964	vaishnavichandekar@gmail.com	V Chandekar
31	Rizunali R. Sonbaxe	9850163812	Sonbaxenzunali16@gmail.com	Rizunali
32	Neha. A. Waghade	7249895144	nehawaghade16082002@gmail.com	N. Waghade
33	Rani B. Kutuale	9011247030	brani8112@gmail.com	Rani
34	Rakhi. P. Gedam	7378312509	gedumrakhii.2000@gmail.com	Rakhi
35	Jayashree D. Hiwase	7385473157	Jayashree12@gmail.com	J. D. Hiwase
36	Aspita. T. Dakhale	8010866758	Aspitadakhale2@gmail.com	A. Dakhale
37	Neha R. Khawase	8766738340	nehar2002k@gmail.com	N. Khawase
38	Asha. S. Landge	9322231581	ashalandge001@gmail.com	Asha. S. Landge
39	Sakshi P. Mankar	8180816539	sakshiz15mm@gmail.com	S. Mankar

Signature of:

Programme In-charge

COORDINATOR
INTERNAL QUALITY ASSURANCE CELL,
DHARAMPETH, M. P. DEO MEMORIAL &
SCIENCE COLLEGE, NAGPUR

Principal
Dharampeth M. P. Deo Memorial
Science College, Nagpur.



DHARAMPETH M. P. DEO MEMORIAL SCIENCE COLLEGE, NAGPUR
INTERNAL QUALITY ASSURANCE CELL (IQAC)

Activity Report

Date: 31, March 2023

Name of Organizing Department or Committee: BOTANY DEPARTMENT

Name of the activity: Puzzle on plant tissue culture.

Suggested CRITERION point if any: CRITERION-I

Date of Activity: 31, March 2023

Place of Activity: DHARAMPETH M.P. DEO MEMORIAL SCIENCE COLLEGE

Name of Guest Speaker/s or Judge/s or Chief Guest/s if any: Dr. Mrs. Sweta Rai

Title of the Activity: Puzzles on plant tissue culture

Number of Participants: 43

Name of the Teacher In-charge / Convener: Prof. Pitambar Humane

Names of other Committee Members / Staff: Dr. Chandrakumar Patle, Mr. Amol Pimpalshende, Dr. Mrs. Reshma Hiwase, Dr. Mrs. Sweta Rai & Mrs. Dipali Nikure

OUTCOME of the Activity with respect to mission vision of the institute and or academics:

This activity knowledge of different techniques of tissue culture develops creativity, thinking, cognitive skill among students. This study has developed curiosity and keen interest among students. This activity imparts knowledge among students how a single cell can further be developed into new shoot or plants by various techniques.

Activity with newspaper coverage if any: NA

Activity data save in PC of: Dr, Sweta A. Rai's Laptop



Prof. Pitambar Humane
IQAC Coordinator

INTERNAL QUALITY ASSURANCE CELL
DHARAMPETH M. P. DEO MEMORIAL &
SCIENCE COLLEGE, NAGPUR

Name & Signature of Teacher In-charge
Dr. Sweta A. Rai

Dr. Akhilesh Peshwe
Principal

Dharampeth M.P. Deo Memorial
Science College, Nagpur.



DHARAMPETH M. P. DEO MEMORIAL SCIENCE COLLEGE,
North Ambazari Road, Near Ambazari Lake, Nagpur- 440033

DATA VALIDATION & VERIFICATION (DVV)

Name of the Programme

: Puzzle on Plant tissue culture

Date of the Programme

: 31st March 2023

Name of Chief Guest if any

: _____

Name of Guest Speaker if any

: Dr. Chandrakumar Palle, Mr. Amol Pimpalshende, Dr. Peshma Hiwaj

Sr. No.	Name of the Participant	Mobile Number	E-mail Id	Signature
1.	BhumiKa D. chedge	8830391103	bhumiKachedge@gmail.com	
2.	Suman A. Singh	4249465307	smi55sumanSingh3@gmail.com	
3.	Vivek R. Wahurwagh	8956482591	vivekrahurwagh89@gmail.com	
4.	Amushi. S. Wele	8530778433	amushiweli@gmail.com	
5.	Anjali R. Pali	7498102109	anjaliipali@gmail.com	
6.	Ayushi Shukla	9373668043	ayushishukla2812000@gmail.com	
7.	Madhura Bhordwe	8767484914	Madhurabhordwe@gmail.com	
8.	Kaustabh R. Ramteke	7218487714	kaustabh.kaustabh2002@gmail.com	
9.	Pamijsha R. Choudhary	7517090406	choudharypamijsha26@gmail.com	
10.	Krushnali S. Kadu	8625854995	krushnalikadu67@gmail.com	

Signature of:

Programme in-charge

CO ORDINATOR
INTERNAL QUALITY ASSURANCE CELL
DHARAMPETH, M. P. DEO MEMORIAL &
SCIENCE COLLEGE, NAGPUR

Principal
Dharampeth M.P. Deo Memorial
Science College, Nagpur



DHARAMPETH M. P. DEO MEMORIAL SCIENCE COLLEGE,
North Ambazari Road, Near Ambazari Lake, Nagpur- 440033

DATA VALIDATION & VERIFICATION (DVV)

11.	Kaustubh. R. Rautbale	7218487714	kaustubhr2002@gmail.com	Rautbale
12.	Vanshika. C. Yede	7558244609	vanshikayedes@gmail.com	Yede
13.	Shubham. P. Khobragade	9518788915	shubhamkhobragade2001@gmail.com	Shubham
14.	saniya. P. Naik	9370570457	saniyanaik51@gmail.com	Naik
15.	Sakshi. V. Chamate	7709204933	chamate.sakshi24@gmail.com	Sakshi
16.	Prajwal Mungle	9834234902	prajwalmungle123@gmail.com	Mungle
17.	Sanskanti S. Panchbhau	7447613185	sanskantipanchbhau1991@gmail.com	Panchbhau
18.	Samiksha No karalekar	9145253189	Samikshakaralekar	Karalekar
19.	suman. A. Singh.	2249465307	msuman2018@gmail.com	Suman
20.	Roshni M. Bambal	9325853408	Roshni2018bb@gmail.com	Bambal
21.	Bhumika D. chedge	8830391103	bhumikachedge@gmail.com	Chedge
22.	vivek R. Waburwagh	8956482591	vivek.waburwagh99@gmail.com	Waburwagh
23.	Samiksha R. Choudhary	7517090406	choudharysamiksha26@gmail.com	Choudhary
24.	Sayli S. Lokhande	9356413804	sayali.lokhande2910@gmail.com	Lokhande
25.	Anjali R. Pali	7498102109	palianjalir40@gmail.com	Pali
26.	Ayushi Shukla	9373668043	ayushishukla12	Shukla
27.	Rindra Wankhede	8010366529	wankhederindramo29@gmail.com	Wankhede

Signature of:

[Signature]

Programme In-charge

COORDINATOR
IQAC Coordinator
INTERNAL QUALITY ASSURANCE CELL
DHARAMPETH, M. P. DEO MEMORIAL &
SCIENCE COLLEGE, NAGPUR

P. Principal
Dharampeth M.P. Deo Memorial
Science College, Nagpur.



DHARAMPETH M. P. DEO MEMORIAL SCIENCE COLLEGE,
North Ambazari Road, Near Ambazari Lake, Nagpur- 440033

DATA VALIDATION & VERIFICATION (DVV)

28	Ranjali L. Dandale	9325473318	dandaleranjali6@gmail.com	R. Dandale
29	Ajitha Bhat	9421065139	ajithaibhat@gmail.com	Ajitha
30	Aitha Sakharade	9405197842	aithasakharade@gmail.com	Aitha
31	Avanti Chaphekar	7875173847	avanti101@gmail.com	Avanti
32	Saniya P. Naik	9370570457	saniyanalks1@gmail.com	Saniya
33	Shreyash S. Naikwar	9247544199	shreyashnaikwar7@gmail.com	Shreyash
34	Vaishnavi R. Chandekar	7249882964	vaishnavichandekar@gmail.com	Vaishnavi
35	Neha A. Waghade	7249895144	nehawaghade16082002@gmail.com	Neha
36	Rakhi B. Patule	9011247038	bkani8112@gmail.com	Rakhi
37	Rakhi P. Gedam	7378312504	gedamrakhi2000@gmail.com	Rakhi
38	Prerna R. Sonare	9850163812	sonareprerna16@gmail.com	Prerna
39	Aspita T. Dakhale	8010866758	aspitadakhale02@gmail.com	Aspita
40	Jayashree D. Hiwase	7385473157	jayashree10@gmail.com	J. D. Hiwase
41	Asha S. Landge	9322231581	ashalandge@gmail.com	Asha S. Landge
42	Sakshi P. Manekar	8180816539	sakshizal8mm@gmail.com	Sakshi
43	Neha R. Kharade	8766738340	nehaz002k@gmail.com	Neha

Signature of:

Programme In-charge

CO ORDINATOR
INTERNAL QUALITY ASSURANCE CELL
IOAC Coordinator
DHARAMPETH, M. P. DEO MEMORIAL &
SCIENCE COLLEGE, NAGPUR

Principal
Dharampeth M.P. Deo Memorial
Science College, Nagpur.



DHARAMPETH M. P. DEO MEMORIAL SCIENCE COLLEGE, NAGPUR
INTERNAL QUALITY ASSURANCE CELL (IQAC)

Activity Report

Date: 31, March 2023

Name of Organizing Department or Committee: BOTANY DEPARTMENT

Name of the activity: Poster competition on Genetic engineering

Suggested CRITERION point if any: CRITERION-I

Date of Activity: 31, March, 2023

Place of Activity: DHARAMPETH M.P. DEO MEMORIAL SCIENCE COLLEGE

Name of Guest Speaker/s or Judge/s or Chief Guest/s if any: Dr. Mrs. Sweta Rai

Title of the Activity: Poster Competition on Genetic Engineering

Number of Participants: 30

Name of the Teacher In-charge / Convener: Prof. Pitambar Humane

Names of other Committee Members / Staff: Dr. Chandrakumar Patle, Mr. Amol Pimpalshende, Dr. Mrs. Reshma Hiwase, Dr. Mrs. Sweta Rai & Mrs. Dipali Nikure

OUTCOME of the Activity with respect to mission vision of the institute and or academics:

This activity creates art, handwriting skill, calligraphy, creativity, thinking, cognitive skill, healthy competition among students. This study has developed curiosity and keen interest among students.

Activity with newspaper coverage if any: NA

Activity data save in PC of: Dr. Sweta A. Rai's Laptop



CO ORDINATOR
INTERNAL QUALITY ASSURANCE CELL
Prof. Pitambar Humane
DHARAMPETH M. P. DEO MEMORIAL &
IQAC Coordinator NAGPUR

Name & Signature of Teacher In-charge
Dr. Sweta A. Rai

Dr. Akhilesh Peshwe
Principal



DHARAMPETH M. P. DEO MEMORIAL SCIENCE COLLEGE,
North Ambazari Road, Near Ambazari Lake, Nagpur- 440033

DATA VALIDATION & VERIFICATION (DVV)

Name of the Programme : Poster on Genetic Engineering
Date of the Programme : 31.03.23
Name of Chief Guest if any : _____
Name of Guest Speaker if any : _____

Sr. No.	Name of the Participant	Mobile Number	E-mail Id	Signature
1	Ayushi Shukla	9373668043	ayushishukla@gmail.com	
2	Anushri. S. Wele	8530778433	anushriwele@gmail.com	
3	Anjali . R. Pali	7498102109	anjaliarubi@gmail.com	
4	Madhura Bhendue	8767484914	Madhurabhendue@gmail.com	
5	Saniya . P. Naitk	9370570457	saniyanaitk51@gmail.com	
6	Sakshi .V. Chamate	7109204933	chamate.sakshi24@gmail.com	
7	Vaishnavi R. Chandekar	7249882964	vaishnavichandekar@gmail.com	
8	Meunali R. Sonbaxe	9850168812	Sonbaxemeunali16@gmail.com	
9	Neha . A. Waghade	7249895144	nehawaghade16082002@gmail.com	
10	Rani B. Ketuale	9011247038	bkranib112@gmail.com	
11	Rakhi . P. Gjedam	7378312504	gedamrakhis2000@gmail.com	

Signature of:

Program In-charge

COORDINATOR

INTERNATIONAL ASSURANCE CELL
DHARAMPETH, M. P. DEO MEMORIAL &
SCIENCE COLLEGE, NAGPUR

Principal

Dharampeth M. P. Deo Memorial
Science College, Nagpur



DHARAMPETH M. P. DEO MEMORIAL SCIENCE COLLEGE,
North Ambazari Road, Near Ambazari Lake, Nagpur- 440033

DATA VALIDATION & VERIFICATION (DVV)

12	Rinam Wawhedde	8010866529	wawhedorinam07@gmail.com	Rinawhedde
13	Shreyansh S. Naikwar	9447844189	shreyansh.naikwar20@gmail.com	Shreyansh
14	Roshani M. Bambal	9325853405	roshani20866@gmail.com	Rambal
15	Ranjali L. Dand	9325473318	dandranjali01@gmail.com	Redan de
16	Ofarwini R. Bhagat	9421061781	ofarwini.bhagat@gmail.com	Ofarwini R.
17	Attha A. Sakhaswade	9405197842	atthasakhaswade@gmail.com	Akhaswade
18	Avanti A. Chaphekar	7875173847	avanti1011@gmail.com	Avanti
19	Samiksha N. Khandekar	9145253758	samikshakhandekar@gmail.com	Khandekar
20	Buman A. Singh	7249465307	miosumansingh2@gmail.com	Buman
21	Bhumika D. Chedde	8830391103	bhumikachedde@gmail.com	Bhumika
22	Vivek R. Waghmare	8956482591	vivek.waghmare89@gmail.com	Vivek
23	Vanshika C. Yede	7558244609	vanshikayede1@gmail.com	Vanshika
24	Pragwal Mungte	9834234902	pragwalmungte129@gmail.com	Pragwal
25	Shubham Khobragade	9518789915	shubhamkhubragade200@gmail.com	Shubham
26	Samiksha Choudhary	7517090406	choudharysamiksha26@gmail.com	Samiksha
27	Sayali Lokhande	9356413804	sayalilokhande2910@gmail.com	Lokhande
28	Apita Dakhale	8010866758	apitadakhale026@gmail.com	Dakhale

Signature of: 29 Jayashree D. Hiwase
30 Asha S. Landge

Programme In-charge

7385473157 Jithi Hiwase 10@gmail.com J.D. Hiwase
9322235511 Asha Landge 001@gmail.com Asha S. Landge
COORDINATOR
INTERNATIONAL SURVIVANCE GEN.
DHARAMPETH, M. P. DEO MEMORIAL &
SCIENCE COLLEGE, NAGPUR
Principal
Dharampeth M.P. Deo Memorial
Science College, Nagpur.



DHARAMPETH M. P. DEO MEMORIAL SCIENCE COLLEGE, NAGPUR
INTERNAL QUALITY ASSURANCE CELL (IQAC)

Activity Report

Date: 31, March 2023

Name of Organizing Department or Committee: BOTANY DEPARTMENT

Name of the activity: To study different types of dye yielding plants

Suggested CRITERION point if any: CRITERION-I

Date of Activity: 31, March., 2023

Place of Activity: DHARAMPETH M.P. DEO MEMORIAL SCIENCE COLLEGE

Name of Guest Speaker/s or Judge/s or Chief Guest/s if any: Dr. Mrs. Sweta Rai

Title of the Activity: To study different types of dye yielding plants.

Number of Participants:38

Name of the Teacher In-charge / Convener: Prof. Pitambar Humane

Names of other Committee Members / Staff: Dr. Chandrakumar Patle, Mr. Amol Pimpalshende, Dr. Mrs. Reshma Hiwase, Dr. Mrs. Sweta Rai & Mrs. Dipali Nikure

OUTCOME of the Activity with respect to mission vision of the institute and or academics:

This study creates knowledge of different types of dye yielding plants and impart the knowledge about colour, texture, extraction, processing etc. different types of plants varies in their habitat, colour, structure etc, This study has developed curiosity and keen interest among the students.

Activity with newspaper coverage if any: NA

Activity data save in PC of: Dr.Sweta A.Rai's Laptop



Prof. Pitambar Humane
IQAC Coordinator
INTERNAL QUALITY ASSURANCE CELL
DHARAMPETH, M. P. DEO MEMORIAL &
SCIENCE COLLEGE, NAGPUR

Name & Signature of Teacher In-charge

Dr. Sweta A. Rai

Dr. Akhilesh Peshwe
Principal

Dharampeth M.P. Deo Memorial
Science College, Nagpur.



DHARAMPETH M. P. DEO MEMORIAL SCIENCE COLLEGE,
North Ambazari Road, Near Ambazari Lake, Nagpur- 440033

DATA VALIDATION & VERIFICATION (DVV)

Name of the Programme : To study dye yielding plants
Date of the Programme : 31.03.23
Name of Chief Guest if any : _____
Name of Guest Speaker if any : _____

Sr. No.	Name of the Participant	Mobile Number	E-mail Id	Signature
1.	Anushri S. Wele	8530778433	anushriwele@gmail.com	
2.	Anjali R. Pali	9498102109	anjaliipali@gmail.com	
3.	Ayushi Shukla	9373668043	ayushishukla112002@gmail.com	
4.	Madhura U. Bhandare	8767484914	madhuraubhandare@gmail.com	
5.	Rinam C Wankhede	8010966529	wankhederinam03@gmail.com	
6.	Ranjali L. Dandekar	9325473318	dandekaranjali6@gmail.com	
7.	Ojaswini Bhagat	901022618	ojaswinibhagat@gmail.com	
8.	Astha A. Sakharwade	9405197842	asthasakharwade@gmail.com	
9.	Avanti A. Chaphekar	7875173847	avantia1011@gmail.com	
10.	Sanskriti S. Panchbhare	7447613185	Sanskritipanchbhare112002@gmail.com	

Signature of:

Programme In charge

COORDINATOR
INTERNAL QUALITY ASSURANCE CELL
DHARAMPETH, M. P. DEO MEMORIAL &
SCIENCE COLLEGE, NAGPUR

Principal
Dharampeth M. P. Deo Memorial
Science College, Nagpur



DHARAMPETH M. P. DEO MEMORIAL SCIENCE COLLEGE,
North Ambazari Road, Near Ambazari Lake, Nagpur- 440033

DATA VALIDATION & VERIFICATION (DVV)

11.	Kaustubh. R. Ramteke	7218487714	kaustubhramteke2002@gmail.com	Kramteke
12.	Vanshika. C. Yede	7558244609	vanshikayede1@gmail.com	Yede
13.	Sakshi . V. Chamate	7709204933	chamate-sakshi24@gmail.com	Sakshi
14.	Saniya . P. Naik.	9370570457	saniyanais1@gmail.com	Naik
15.	Shubham . P. Khobrajade	9518788915	shubhamkhorrajade2002@gmail.com	Shubham
16.	Prajwal Mungte	9834234902	prajwalmungte23@gmail.com	Mungte
17.	Krushnali Kachle	825864995	krushnalikachle7@gmail.com	Kachle
18.	Suman . A. Singh .	7249465307	missumanslyh2@gmail.com	Singh
19.	Bhumika D. Chedje	8830391103	bhumikachedje@gmail.com	Chedje
20.	Vivek R. Waghmare	8956482591	vivek.waghmare29@gmail.com	Waghmare
21.	Samiksha M. Kunderkar	9145253758	samikshakunderkar@gmail.com	Kunderkar
22.	Samiksha R. Chaudhari	7517090406	shiksha03samiksha@gmail.com	Chaudhari
23.	Roshani M. Bambal	9325853408	roshani2018bb@gmail.com	Bambal
24.	Sayali S. Lokhande	9356413804	sayali.lokhande2910@gmail.com	Lokhande
25.	Ayushi Shukla	9373668043	ayushishukla@gmail.com	Shukla
26.	Saniya . P. Naik	9370570457	saniyanais1@gmail.com	Naik

Signature of:

Programme In-charge

CO ORDINATOR
 IQAC COORDINATOR
 INTERNAL QUALITY ASSURANCE CELL
 DHARAMPETH, M. P. DEO MEMORIAL &
 SCIENCE COLLEGE, NAGPUR

Principal
 Dharampeth M.P. Deo Memorial
 Science College, Nagpur.



DHARAMPETH M. P. DEO MEMORIAL SCIENCE COLLEGE,
North Ambazari Road, Near Ambazari Lake, Nagpur- 440033

DATA VALIDATION & VERIFICATION (DVV)

27	Shreyansh S. Naitwar	7447844189	shreyanshnaitwar7@gmail.com <u>Shaitwar</u>
28	Vaishnavi R. Chandekar	7249882964	vaishnavichandekar@gmail.com <u>Chandekar</u>
29	Meunali R. Sonbaxe	9850163812	sonbaxemeunali16@gmail.com - <u>Sonbaxe</u>
30	Neha. A. Waghade	7249895144	nehawaghade16082002@gmail.com <u>Waghade</u>
31	Rakhi. P. Gedam	7378312504	gedamrakhi2000@gmail.com <u>Rakhi</u>
32	Rani B. Khatule	9011247038	bkxani@112@gmail.com <u>Rani</u>
33	Jayashree D. Hiwase	7385473157	Jshihiwase10@gmail.com <u>J. D. Hiwase</u>
34	Ashita. T. Dakhale	8010866758	ashitadakhale52@gmail.com <u>Dakhale</u>
35	Asha. S. Landge	9322231581	ashalandge001@gmail.com <u>Asha. S. Landge</u>
36	Sakshi. P. Mankar	8180816539	sakshi2018mmm@gmail.com <u>Mankar</u>
37	Neha R. Ichawase	8766738340	neha2002kk@gmail.com <u>Ichawase</u>
38	Anjali. Mishra.	8319948106	am88546@gmail.com <u>Anjali</u>

Signature of:

Programme In-charge

COORDINATOR
INTERNAL QUALITY ASSURANCE CELL
DHARAMPETH, M. P. DEO MEMORIAL &
SCIENCE COLLEGE, NAGPUR

Principal
Dharampeth M.P. Deo Memorial
Science College, Nagpur

460



DHARAMPETH M. P. DEO MEMORIAL SCIENCE COLLEGE, NAGPUR

INTERNAL QUALITY ASSURANCE CELL (IQAC)

Activity Report

Date: 31/03/2023

Name of Organizing Department or Committee: Zoology

Name of the activity: QUIZ on the topic EXCRETORY SYSTEM

Suggested CRITERION point if any: Criteria I

Date of Activity: 31/03/2023

Place of Activity: Department of Home Science, Nagpur

Name of Guest Speaker judge/s or Chief Guest/s if any: NA

Title of the Activity: QUIZ on the topic Excretory system

Number of Participants: 15

Name of the Teacher In-charge / Convener: Dr. B. D. Shrinivas

Names of other Committee Members / Staff: Dr. K. M. Paturkar

OUTCOME of the Activity with respect to mission vision of the institute and or academics:

The Objective behind to organize Quiz competition is to evaluate the knowledge of the participants within academics as well as beyond academics and to make them familiar with the prospects of quiz and the objectivity of the questions. The main purpose of the competition is to develop interest in subject area.

Students get in depth knowledge about STRUCTURE OF KIDNEY , NEPHRON AND their functions.

Students have better idea of how well they are grasping study material.

Students get motivation to study more and helpful in managing study time effectively.

Quiz help Students to boost their confidence and importance of subject.

Activity with newspaper coverage if any: NIL

Activity data save in PC of: Zoology Department/personal laptop



Bharti

Dr. Bharti Shrinivas

Name & Signature of Teacher In-charge

Pitambar Humane

Prof. Pitambar Humane

IQAC Coordinator
CO ORDINATOR
INTERNAL QUALITY ASSURANCE CELL
SHARAMPETH, M. P. DEO MEMORIAL &
SCIENCE COLLEGE, NAGPUR

Akhillesh Peshwe

Dr. Akhillesh Peshwe

Principal
Principal
Sharampeth M. P. Deo Memorial
Science College, NAGPUR.



DHARAMPETH M. P. DEO MEMORIAL SCIENCE COLLEGE,
North Ambazari Road, Near Ambazari Lake, Nagpur- 440033

DATA VALIDATION & VERIFICATION (DVV)

Home Sci
SEM - III
U - I

Name of the Programme : Quiz competition (U - I)
Date of the Programme : 31.03.23
Name of Chief Guest if any : -
Name of Guest Speaker if any : -

Sr. No.	Name of the Participant	Mobile Number	E-mail Id	Signature
1.	Avani S. Shenwai	9096507459	avanishenwai15@gmail.com	
2.	Karuna T. Diwe	9286237778	clivetraining26@gmail.com	
3.	Archita A. Madhe	9975034151	madhearchita@gmail.com	
4.	Kimaya N. Kale	8966073792	kimayakale001@gmail.com	
5.	Ujasvi Wankhede	8767699751	wankhedeujasvi@gmail.com	
6.	Tannu Korde	7841984450	Kordetannu130@gmail.com	
7.	Pranali Ghargadkar	9309079427	Pranali2gh@gmail.com	
8.	Pranjakta Wankhede	8459413596	pranjakta.wankhede148	
9.	Suyata Kawate	9175451202	suyatakawate@gmail.com	
10.				
11.				
12.				
13.				
14.				
15.				

Signature of:
Programme In-charge

IQAC Coordinator
CO ORDINATOR

INTERNAL QUALITY ASSURANCE CELL
DHARAMPETH, M. P. DEO MEMORIAL &
SCIENCE COLLEGE, NAGPUR

Principal
Principal

Dharampeth M. P. Deo Memorial
Science College, NAGPUR

461



DHARAMPETH M. P. DEO MEMORIAL SCIENCE COLLEGE, NAGPUR

INTERNAL QUALITY ASSURANCE CELL (IQAC)

Activity Report

Date: 31/03/2023

Name of Organizing Department or Committee: Zoology

Name of the activity: QUIZ on the topic REPTILIA, AVES, MAMMALS (UNIT – I)

Suggested CRITERION point if any: Criteria I

Date of Activity: 31/03/2023

Place of Activity: Department of ZOOLOGY, Nagpur

Name of Guest Speaker judge/s or Chief Guest/s if any: NA

Title of the Activity: QUIZ on the topic REPTILIA, AVES, MAMMALS

Number of Participants: 26

Name of the Teacher In-charge / Convener: Dr. B. D. Shrinivas

Names of other Committee Members / Staff: Dr. K. M. Paturkar

OUTCOME of the Activity with respect to mission vision of the institute and or academics:

The Objective behind to organize Quiz competition is to evaluate the knowledge of the participants within academics as well as beyond academics and to make them familiar with the Poison apparatus, biting mechanism, Ratitae and Caranitae, Prototheria, Metatheria and Eutheria and the objectivity of the questions. The main purpose of the competition is to develop interest in subject area.

Students get in depth knowledge about importance of snake venom and its functions.

Students have better idea of how well they are grasping study material.

Students get motivation to study more and helpful in managing study time effectively.

Quiz help Students to boost their confidence and importance of subject.

Activity with newspaper coverage if any: NIL

Activity data save in PC of: Zoology Department/personal laptop



Bharti

Dr. Bharti Shrinivas

Name & Signature of Teacher In-charge

Pitambar

Prof. Pitambar Humane

IQAC Coordinator

**CO ORDINATOR
INTERNAL QUALITY ASSURANCE CELL
DHARAMPETH, M. P. DEO MEMORIAL &
SCIENCE COLLEGE, NAGPUR**

Akhilesh

Dr. Akhilesh Peshwe

Principal

Principal

**Dharampeth M. P. Deo Memorial
Science College, NAGPUR.**



DHARAMPETH M. P. DEO MEMORIAL SCIENCE COLLEGE,
North Ambazari Road, Near Ambazari Lake, Nagpur- 440033

DATA VALIDATION & VERIFICATION (DVV)

Name of the Programme : Quiz Competition (Paper I, U-I)
 Date of the Programme : 31.03.23
 Name of Chief Guest if any : —
 Name of Guest Speaker if any : —

Sr. No.	Name of the Participant	Mobile Number	E-mail Id	Signature
1.	Vaishali S. Patle	9322600647	Vaishalipatle156@gmail.com	<u>Vaishali</u>
2.	Shabir R. Shaikh.	8329346137	shabir1107k@gmail.com	<u>Shabir</u>
3.	Subbu Mishra	9860436418	subbumishra234@gmail.com	<u>Subbu</u>
4.	Tanushree Bhagat	9834968808	tanubhagat1227@gmail.com	<u>Tanushree</u>
5.	Shruti Mangesh Pawar	9322066207	SP997494@gmail.com	<u>Shruti</u>
6.	Shruya S. Bagde.	8669883639	bagdeshruya78@gmail.com	<u>Shruya</u>
7.	Riya R. Kulmethe.	7420956528	Riyakulmethe12@gmail.com	<u>Riya</u>
8.	Shruti P. Masram	8308657972	shrutimasram@gmail.com	<u>Shruti</u>
9.	Shikha J. Yadav	7263881320	Shikha.yadav@gmail.com	<u>S.J. Yadav</u>
10.	Yukti S. Choudhary	7020953938	yukti.choudhary102@gmail.com	<u>Yukti</u>
11.	Varsha R. Tiwari	8408097938	Varshatiwari722@gmail.com	<u>Varsha</u>
12.	Yashviree P. Chande	9764008929	yashviree.chande@gmail.com	<u>Yashviree</u>
13.	Tina M. Rahangdale	9921776769	tinarahangdale@gmail.com	<u>Tina</u>
14.	Pooja S. Itankar	9156973252	poojaitankar7@gmail.com	<u>Pooja</u>

Signature of: Chait
 Programme In-charge

COORDINATOR
 INTERNAL QUALITY ASSURANCE CELL
 DHARAMPETH, M. P. DEO MEMORIAL &
 SCIENCE COLLEGE, NAGPUR

Principal
 Dharampeth M. P. Deo Memorial
 Science College, Nagpur



DHARAMPETH M. P. DEO MEMORIAL SCIENCE COLLEGE,
North Ambazari Road, Near Ambazari Lake, Nagpur- 440033

DATA VALIDATION & VERIFICATION (DVV)

Sr. No.	Name of the Participant	Mobile Number	E-mail Id	Signature
	Uamila V. Bhandar	9370673868	bhandarvamila.2000@gmail.com	
	Shreya Dhanale	8988204004	shreyadhanale.124@gmail.com	
	Vaibhavi Shende	8080790482	Vaibhavishende97@gmail.com	
	Chhakuli Wadikar	9325047907	chhakuliwadikar@gmail.com	
	Robit A Patate	9373097285	patate.rohit8@gmail.com	
	Vaishnavi R. Lakhe	8669694866	chhakuli.lakhe33@gmail.com	
	Vaishnavi R. Nandhure	9322439316	VaishnaviNandhure36@gmail.com	
	Kalpna D. Sahagpure	9579236712	kalpanasahagpure7@gmail.com	
	Niket Thakre	7328999092	niketthakre92@gmail.com	
	Siddharth Hikkane	9579092931	hikkane.siddharth@gmail.com	
	Dhanshree Y. Newalkar	9356516280	newalkardhanshree@gmail.com	
	Rupesh Bhokre	8805887580	bhokrerupesh@gmail.com	

Signature of: Dharti
Programme In-charge

COORDINATOR
INTERNAL QUALITY ASSURANCE CELL
DHARAMPETH, M. P. DEO MEMORIAL &
SCIENCE COLLEGE, NAGPUR

Principal
Principal
Dharampeth M. P. Deo Memorial
Science College, NAGPUR



DHARAMPETH M. P. DEO MEMORIAL SCIENCE COLLEGE, NAGPUR
INTERNAL QUALITY ASSURANCE CELL (IQAC)
Activity Report

Date: 31/3/2023

Name of Organizing Department or Committee: Microbiology Department

Name of the activity: NEP Activity

Suggested CRITERION point if any: Criterion II & V

Date of Activity: 31/03/2023

Place of Activity: Department of Microbiology

Name of Guest Speaker/s or Judge/s or Chief Guest/s if any: Guest Speaker - Nil

Title of the Activity: Making of Flowchart On Production Of
BCG/Polio/Edible Vaccines

Number of Participants: 19

Name of the Teacher In-charge / Convener: Dr. Mrs Vaishali Pimple

Names of other Committee Members: Nil

OUTCOME of the Activity with respect to mission vision of the institute and or
academics: Students understood the process of Vaccine production in easier way.

Activity with newspaper coverage any: Nil

Name & Signature of Teacher In-charge

Prof. Pitambar Humane
IQAC Coordinator

Dr. Akhilesh Peshwe
Principal

CO ORDINATOR
INTERNAL QUALITY ASSURANCE CELL
DHARAMPETH M. P. DEO MEMORIAL &
SCIENCE COLLEGE, NAGPUR

Principal
Dharampeth M. P. Deo Memorial
Science College, Nagpur



DHARAMPETH M. P. DEO MEMORIAL SCIENCE COLLEGE,
North Ambazari Road, Near Ambazari Lake, Nagpur- 440033

BSc Sem VI
NEP - 2

DATA VALIDATION & VERIFICATION (DVV)

Name of the Programme : Chart on 'Flow Chart of Production of BCG / edible / Polio Vaccines
Date of the Programme : BSc Sem VI
Name of Chief Guest if any :
Name of Guest Speaker if any :

Sr. No.	Name of the Participant	Mobile Number	E-mail Id	Signature
1.	Shiwani S.R. Dwivedi	8855900546	shiwaniidwivedi41@gmail.com	
2.	Krushnali S. Kadu	8625854995	krushnali kadu67@gmail.com	
3.	Shreyansh S. Naikwar.	7447844189	shreyanshnaikwar7@gmail.com	
	Sayli S. Lohande	9356413864	Sayali lohande2910@gmail.com	
5.	Samiksha Kundekar	9145253758	samikshakundekar18@gmail.com	
6.	Samiksha Chaudhari	7517090406	samikshachaudhari@gmail.com	
7.	Anjali R. Pali	7498102109	palianjali446@gmail.com	
8.	Anushui Wele	8530778433	anushuiwele@gmail.com	
9.	Shreuti Pawar	9527988707	shreutipawar0001@gmail.com	
10.	Ishika Thakur	8010907069	ishithakur22@gmail.com	

Signature of:

Programme In-charge

IOAC Coordinator

INTERNAL QUALITY ASSURANCE CELL
DHARAMPETH, M. P. DEO MEMORIAL &
SCIENCE COLLEGE, NAGPUR

Principal

Principal

Dharampeth M. P. Deo Memorial



DHARAMPETH M. P. DEO MEMORIAL SCIENCE COLLEGE,
North Ambazari Road, Near Ambazari Lake, Nagpur- 440033

DATA VALIDATION & VERIFICATION (DVV)

11.	Laxmi Goude		laxmigoode2908@gmail.com	Laxmi
12.	Nandini Hadge	7758058514	nandinihadge19@gmail.com	Nandini
13.	Bhargavi Sambhare	9370301679	bhargavisambhare08@gmail.com	Bhargavi
14.	Madhura U. Bhondwe	7709403806	madhuraabhondwe@gmail.com	Madhura
15.	Rinam C Wankhede	8767484914	wankhederinam07@gmail.com	Rinam
16.	Ayushi Shukla	8010966529	ayushishukla28112002@gmail.com	Ayushi
17.	Aishwarya Joshi	9373668093	aishwaryajoshi2003@gmail.com	Aishwarya
18.	Manali Shinde	7498328562	manalishinde062@gmail.com	Manali
19.	Tommay Y. Chaudhari	7249637434	tchaudhari8600@gmail.com	Tommay
		8600102341		

Signature of:

Programme In-charge

IQAC Coordinator

Principal



DHARAMPETH M. P. DEO MEMORIAL SCIENCE COLLEGE
INTERNAL QUALITY ASSURANCE CELL (IQAC)
Activity Report

Date : 3rd April 2023

Name of The Organizing Department or Committee : Electronics Department
Name of the Activity : Simple programs on timer and interrupts
Suggested CRITERION point if any : Suggested criterion II
Date of Activity : 3rd April 2023
Place of Activity : Electronics Lab

Name of Guest Speaker/s or Judge/s or Chief Guest/s if any : Not applicable
Title of the Activity : Simple programs on timer and interrupts
Based on Unit : 3(Paper II)
Class : Semester VI
Number of Participants : 18
Name of the Teacher In -charge/Convener : Prof. V. V. Rangari

OUTCOME of the Activity with respect to mission vision of the institute and or academic :
Students learned how to use timers and interrupts in microcontroller 8051. They also learned how to write simple programs on timers and interrupts.



Prof. V. V. Rangari

Head of the Department



Prof. Pitambar Humne

IQAC Cordinator

CO ORDINATOR

INTERNAL QUALITY ASSURANCE CELL
DHARAMPETH, M. P. DEO MEMORIAL &
SCIENCE COLLEGE, NAGPUR



Dr. Akhilesh Peshwe

Principal

Principal

Dharampeth M.P. Deo Memorial
Science College, Nagpur



DHARAMPETH M. P. DEO MEMORIAL SCIENCE COLLEGE, NAGPUR

Department of Electronics

Semester VI- (2022-23)

ACTIVITY (Paper II- Unit- 3)

Sr. No.	Student Name	Mobile Number	Email ID
1	Aarti Brijkishor Singh	7709208740	aartibsingh222@gmail.com
2	Sakshi Sanjay Huddar	9405142450	huddarmahi@gmail.com
3	Riddhi Abhay Rajkarne	8669809201	riddhirajkarne@gmail.com
4	Bhavesh Rameshwar Maske	7489951631	bhaveshmaske2002@gmail.com
5	Tanmay Sunil Gadam	7262034396	tanmaygadaml@gmail.com
6	Samiksha Vasant Tabhane	9307133863	samikshavtabhane@gmail.com
7	Kiran Ramesh Waghade	9860218676	rameshwaghade20@gmail.com
8	Megha Tribhuwan Bisen	9637770341	bisenmegha320@gmail.com
9	Sagar Omprakash Sonwane	9356591564	sagarsonwane706@gmail.com
10	Ankita Laxman Sonwane	9284801790	ankitasonwane10@gmail.com
11	Pratiksha Shamrao Umare	8806402970	pratiksha2019uu@gmail.com
12	Rani Devidas Kokate	7998945148	ranikokate1009@gmail.com
13	Ankit Dilip Singh	9307189124	as4212892@gmail.com
14	Adesh Kamalkishor Dubey	9527898267	Adesh222@gmail.com
15	Ankur Singh	7507990175	akashdsingh059@gmail.com
16	Shaunak Subodh Balkundi	8446629345	
17	Pratik Deepak Ingle	7057937510	inglepratik92@gmail.com
18	Prathmesh Sanju Badhiye	9765262138	nikita24badhiye@gmail.com

Name & Signature of Teacher In-Charge

Prof. Pitambar Humane
IQAC Coordinator

CO ORDINATOR
INTERNAL QUALITY ASSURANCE CELL
DHARAMPETH, M. P. DEO MEMORIAL &
SCIENCE COLLEGE, NAGPUR

Name & Signature of Head of the Department

Dr. Varsha V. Rangari

Professor & Head
Department of Electronics
Dharampeth M.P. Deo Memorial
Science College, Nagpur

Dr. Akhilesh Peshwe
Principal

Principal
Dharampeth M.P. Deo Memorial
Science College, Nagpur.



**DHARAMPETH M. P. DEO MEMORIAL SCIENCE COLLEGE
INTERNAL QUALITY ASSURANCE CELL (IQAC)**

Activity Report

Date : 10th April 2023

Name of The Organizing Department or Committee : Electronics Department

Name of the Activity : Programs on interfacing

Suggested CRITERION point if any : Suggested criterion II

Date of Activity : 10th April 2023

Place of Activity : Electronics Lab

Name of Guest Speaker/s or Judge/s or Chief Guest/s if any : Not applicable

Title of the Activity : Programs on interfacing

Based on Unit : 4(Paper II)

Class : Semester VI

Number of Participants : 18

Name of the Teacher In -charge/Convener : Prof. V. V. Rangari

OUTCOME of the Activity with respect to mission vision of the institute and or academic :

Students learned how to write the program to interface 4*4 keyboard, LED, Seven Segment Display, LCD, ADC, DAC and relay with microcontroller 8051.



Prof. V. V. Rangari

Head of the Department



Prof. Pitambar Humne

IQAC Cordinator

CO ORDINATOR

**INTERNAL QUALITY ASSURANCE CELL
DHARAMPETH, M. P. DEO MEMORIAL &
SCIENCE COLLEGE, NAGPUR**



Dr. Akhilesh Peshwe

Principal

Principal

**Dharampeth M.P. Deo Memorial
Science College, Nagpur.**



DHARAMPETH M. P. DEO MEMORIAL SCIENCE COLLEGE, NAGPUR
Department of Electronics
Semester VI- (2022-23)
ACTIVITY (Paper II- Unit-4)

Sr. No.	Student Name	Mobile Number	Email Id
1	Aarti Brijkishor Singh	7709208740	aartibsingh222@gmail.com
2	Sakshi Sanjay Huddar	9405142450	huddarmahi@gmail.com
3	Riddhi Abhay Rajkarne	8669809201	riddhirajkarne@gmail.com
4	Bhavesh Rameshwar Maske	7489951631	bhaveshmaske2002@gmail.com
5	Tanmay Sunil Gadam	7262034396	tanmaygadaml@gmail.com
6	Atharv Vilasrao Girhe	8080317649	amangirhe24@gmail.com
7	Samiksha Vasant Tabhane	9307133863	samikshavtabhane@gmail.com
8	Kiran Ramesh Waghade	9860218676	rameshwaghade20@gmail.com
9	Megha Tribhuwan Bisen	9637770341	bisenmegha320@gmail.com
10	Sagar Omprakash Sonwane	9356591564	sagarsonwane706@gmail.com
11	Ankita Laxman Sonwane	9284801790	ankitasonwane10@gmail.com
12	Pratiksha Shamrao Umare	8806402970	pratiksha2019uu@gmail.com
13	Rani Devidas Kokate	7998945148	ranikokate1009@gmail.com
14	Ankit Dilip Singh	9307189124	as4212892@gmail.com
15	Adesh Kamalkishor Dubey	9527898267	Adesh222@gmail.com
16	Ankur Singh	7507990175	akashdsingh059@gmail.com
17	Shaunak Subodh Balkundi	8446629345	
18	Pratik Deepak Ingle	7057937510	inglepratik92@gmail.com

Name & Signature of Teacher In-Charge



Prof. Pitambar Humane
IQAC Coordinator

CO ORDINATOR

INTERNAL QUALITY ASSURANCE CELL
DHARAMPETH, M. P. DEO MEMORIAL
SCIENCE COLLEGE, NAGPUR.

Name & Signature of Head of the Department

Dr. Varsha V. Rangari
Professor & Head
Department of Electronics
Dharampeth M.P. Deo Memorial
Science College, Nagpur

Dr. Akhilesh Peshwe
Principal
Principal

Dharampeth M.P. Deo Memorial
Science College, Nagpur.



Dharampeth M.P.Deo Memorial Science College, Nagpur

Department Of Computer Science

Academic Session: 2022-2023

NOTICE

All the Students of B.Sc.Sem VI are hereby informed that the Department of Computer Science is organizing a Guest Lecture on "CURSOR AND EXCEPTION HANDLING" on 11/04/2023 at 11.10am. All the students attend this program positively.

Venue: Computer Science Laboratory

Date: 05/4/2023

Place: Nagpur

Dr. Mrs. Snehal Narale

Dr. Akhilesh Peshwe
(Principal)
Principal
Dharampeth M. P. Deo Memorial
Science College, Nagpur



**DHARAMPETH M. P. DEO MEMORIAL SCIENCE COLLEGE, NAGPUR
INTERNAL QUALITY ASSURANCE CELL (IQAC)**

NEP Activity Report

Date: 15th April 2023

Name of Organizing Department or Committee: Computer Science Department

Name of the activity: Guest Lecture

Suggested CRITERION point if any: Criteria II, V

Date of Activity: 11/04/2023

Place of Activity: Computer Science Laboratory

Name of Guest Speaker/s or Judge/s or Chief Guest/s if any: Mrs. Subhashini Chourasia,
Head Department of Computer Science, S.S Maniar College, Nagpur

Title of the Activity: Cursor and Exception handling for students of SEM VI [Unit III]

Number of Participants: 32

Name of the Teacher In-charge / Convener: Dr. Mrs. Snehal Narale

Names of other Committee Members / Staff: Nil

OUTCOME of the Activity with respect to mission vision of the institute and or academics:

The objective of this activity was to provide platform to the students through which they can understand the detail concept of cursor and exception handling in PL-SQL Programming . In this lecture, guest speaker explain the topics as

- What is PL/SQL ?
- How it is different from other programming languages?
- What are exceptions ?
- How to handle the exceptions in PL/SQL?
- Definition and Working of Cursor in PL/SQL in Brief.

Guest lecturers provide a vital educational experience for the students based on their real-world life experiences. Students get to see the insight and perspective of the guest lecturers' specific field. One of the benefit of the lecture was to get the students and understand the difference between what they learn in their textbooks and the experiences shared by the guest speaker. Students thereby build important connections between what they have learned and the real world.

Activity with newspaper coverage if any: Nil

Activity data save in PC of: Dr. Mrs. Snehal Narale's Laptop



[Handwritten Signature]

[Handwritten Signature]

Name & Signature of Teacher In-charge

Prof. Pitambar Humane
IQAC Coordinator

Dr. Akhil B. Deshwe
Principal



DHARAMPETH M. P. DEO MEMORIAL SCIENCE COLLEGE,
North Ambazari Road, Near Ambazari Lake, Nagpur - 440033

DATA VALIDATION & VERIFICATION (DVV)

Name of the Programme : Guest Lecture [Sem V]
 Date of the Programme : 11/04/2023
 Name of Chief Guest if any : _____
 Name of Guest Speaker if any : Mrs. Subhashini Chourasia

Sr. No.	Name of the Participant	Mobile Number	E-mail Id	Signature
1]	Pratiksha S. Chaudhari	7507317633	cmudharypratiksha2000@gmail.com	
2]	Pooja A. Rai	9255923509	soniswaral19@gmail.com	
3]	Kar. Sujata. Dharmaj. Sonasane	9021135540	sujatajadharmaj2008@gmail.com	
4]	Samiksha R. Khasare	9604473539	seknakhare@gmail.com	
5]	Diya R. Patil	7757052463	diyapatil593@gmail.com	
6]	Pooja D. Soudkar	7385458510	paunjabsonu1234@gmail.com	
7]	Khushi D. Dave	9890009982	k4912141@gmail.com	
8]	Taru S. Mohale	7057944382	tarumohale2002@gmail.com	
3]	Neha J. Bankar	8055477553	nehajeebankar@gmail.com	
10]	Komal M. Kumbhare	7620314869	Kumbhare Komal74@gmail.com	

Signature of:

Programme In-charge

IQAC Coordinator

INTERNAL QUALITY ASSURANCE CELL
DHARAMPETH M. P. DEO MEMORIAL &
SCIENCE COLLEGE, NAGPUR

Principal
Dharampeth M. P. Deo Memorial
Science College, Nagpur



DHARAMPETH M. P. DEO MEMORIAL SCIENCE COLLEGE,
North Ambazari Road, Near Ambazari Lake, Nagpur- 440033

DATA VALIDATION & VERIFICATION (DVV)

12)	Dikshita P. Sahane	9028830801	dikshitasahane@gmail.com	Dikshita
13)	Khushi A. Gupta	9922994235	kg998120@gmail.com	Khushi
14)	Abdul Rahe Aman	7666338578	raheaman2011@gmail.com	Abdul
15)	Pranay S. Dhow	8055292113	pranay9@gmail.com	Pranay
16)	Sahil R. Jitode	4373414043	sahiljitode73@gmail.com	Sahil
17)	Saurabh V. Raut	9524293213	saurabh20614725@gmail.com	Saurabh
18)	Jatong P. Panke	9422488044	jatongpanke2012@gmail.com	Jatong
19)	Tanmay S. Gadam	7262034396	tanmaygadams1@gmail.com	T.S.Gadam
20)	Vinhal V. Girhale	9673681472	vinhalgirhale27@gmail.com	Vinhal
21)	Bhavesh D. Mathur	9021317056	bhaveshmathur31@gmail.com	Bhavesh
22)	Sanchit M. Joshi	8775706780	sanchitjoshi21@gmail.com	Sanchit
23)	Aakash Das	7972942799	akash4@gmail.com	Aakash
24)	Ashirbek A. Falke	7823835335	ashirbekfalke33@gmail.com	Ashirbek
25)	Rishi L. Chavhan	8180362184	rishi1011chavhan@gmail.com	Rishi
26)	Prathom - M - Sonawane	7558464862	SonawanePrathom434@gmail.com	Prathom
27)	Mahesh. Maske	9021951173	maheshmaske48@gmail.com	Mahesh

Signature of:

Programme In-charge

IQAC Coordinator

INTERNAL QUALITY ASSURANCE CELL
DHARAMPETH M. P. DEO MEMORIAL
SCIENCE COLLEGE, NAGPUR

Principal
Dharampeth M. P. Deo Memorial
Science College, Nagpur



**DHARAMPETH M. P. DEO MEMORIAL SCIENCE COLLEGE
INTERNAL QUALITY ASSURANCE CELL (IQAC)**

Activity Report

Date : 12th April 2023

Name of the Organizing Department or Committee : Electronics Department

Name of the Activity : Tracing of Power supply circuit

Suggested CRITERION point if any : Suggested criterion II

Date of Activity : 12th April 2023

Place of Activity : Electronics Lab

Name of Guest Speaker/s or judge/s or Chief Guest/s if any : Not applicable

Title of the Activity : Tracing of Power supply circuit

Based on Unit : 2(Paper II)

Class : Semester IV

Number of Participants : 17

Name of the Teacher In- charge/convener : Mrs. Leena P. Thakare

OUTCOME of the Activity with respect to mission vision of the institute and or academic:
Students are able to trace the power supply circuit.

Prof. V. S. Rangari
Head of the Department



Prof. Pitambar Humne

IQAC Cordinator

CO ORDINATOR

**INTERNAL QUALITY ASSURANCE CELL
DHARAMPETH, M. P. DEO MEMORIAL &
SCIENCE COLLEGE, NAGPUR**



Dr. Akhilesh Peshwe

Principal

Principal

**Dharampeth M.P. Deo Memorial
Science College, Nagpur.**



DHARAMPETH M. P. DEO MEMORIAL SCIENCE COLLEGE, NAGPUR

Department of Electronics

Semester IV- (2022-23)

ACTIVITY (PAPER II – UNIT 1)

Sr. No.	Student Name	Mobile No.	Email ID
1	Sadhana Mitaram Pardhi	9067539417	pradhishubhangi4@gmail.com
2	Yash Ravindra Khedekar	7020829422	yashkhedekar5@gmail.com
3	Ankush Samma Gawade	7588194156	agawde5603@gmail.com
4	Saurav Komalprasad Uikey	9356088871	sauravuikey6@gmail.com
5	Renuka Vishal Lande	7719951401	renukalande220@gmail.com
6	Priyanka Shilanath Shah	7796385608	rs3347310@gmail.com
7	Aasmin Abdulkhaliq Sheikh	8788490684	abdulkhalik563698@gmail.com
8	Rahul Ramesh Kawade	9359525716	kawaderahul042@gmail.com
9	Urvashi Sunilrao Umathe	9527708361	pragatichaure01@gmail.com
10	Chetan Umashankar Bopche	9172484628	chetanbopche27@gmail.com
11	Unnatitai Chatrapal Chopde	9022627617	unnatichopde2002@gmail.com
12	Pratham Ankush Sitkare	9022553288	prathamsitkare@gmail.com
13	Mansi Dilip Nandanwar	7709322027	mansinandanwar19@gmail.com
14	Janvi Ashok Kosarkar	8975756916	Janvikosarkar@gmail.com
15	Bhagyarathi Ramvinay Pandey	9175302601	pandeybhagyarathi@gmail.com
16	Durgesh Krishna Singh	7385310432	ds608531@gmail.com
17	Sakshi Vinod Kanade	8806934839	Sakshikanade326@gmail.com

Name & Signature of Teacher In-Charge

Prof. Pitambar Humane
IQAC Coordinator

CO ORDINATOR
INTERNAL QUALITY ASSURANCE CELL
DHARAMPETH, M. P. DEO MEMORIAL &
SCIENCE COLLEGE, NAGPUR

Name & Signature of Head of the
Department

--- Vansha V. Rangari
Professor & Head
Department of Electronics
Dharampeth M.P. Deo Memorial
Science College, Nagpur

Dr. Akhilesh Peshwe
Principal
Principal
Dharampeth M.P. Deo Memorial
Science College, Nagpur.



DHARAMPETH M. P. DEO MEMORIAL SCIENCE COLLEGE, NAGPUR
INTERNAL QUALITY ASSURANCE CELL (IQAC)

Activity Report

Date: 13.04.2023

Name of Organizing Department or Committee: Dept of Home Science

Name of the activity: Visit to Food Production Facility

Suggested CRITERION point if any:

Date of Activity: 13.04.2023

Place of Activity: Renaissance Superfoods Pvt. Ltd., Ram Nagar, Nagpur.

Name of Guest Speaker/s or Judge/s or Chief Guest/s if any: Mr. Swapnil Muley & Dr. Juhi Muley

Title of the Activity: Visit to Food Production Facility

Number of Participants: 24

Name of the Teacher In-charge / Convener: Mrs. Meghna Pandit

Names of other Committee Members / Staff: Dr. Ashwini Meshram

OUTCOME of the Activity with respect to mission vision of the institute and or academics:

To develop practical understanding of hygiene practices and food production processes in real-life industry setting.

Activity with newspaper coverage if any: NA

Activity data save in PC of: Home Science Department Desktop



Prof. Pitambar Humane
COORDINATOR
INTERNAL QUALITY ASSURANCE CELL
DHARAMPETH, M. P. DEO MEMORIAL &
SCIENCE COLLEGE, NAGPUR

Name & Signature of Teacher In-charge

(Mrs. Meghna Pandit)

Dr. Akhilesh Peshwe

PRINCIPAL
DHARAMPETH M. P. DEO
MEMORIAL SCIENCE COLLEGE
NAGPUR



DHARAMPETH M. P. DEO MEMORIAL SCIENCE COLLEGE,
North Ambazari Road, Near Ambazari Lake, Nagpur-440033

DATA VALIDATION & VERIFICATION (DVV)

Name of the Programme : VISIT TO FOOD PRODUCTION FACILITY
Date of the Programme : 13/04/2023
Name of Chief Guest if any : MR. SWARNIL MULEY
Name of Guest Speaker if any : DR. JUHI MULEY

Sr. No.	Name of the Participant	Mobile Number	E-mail id	Signature
1	Kimaya Kale	8866073992	kimayakale005@gmail.com	Kimaya
2	Anani Shermai	9096307459	Ananishernani5@gmail.com	A Shermai
3	Ojasvi Wankhede	8767699751	Wankhede ojasvi@gmail.com	Ojasvi
4	Pragy Tiwari	6394098386	Pragyatiwari14052007@gmail.com	Pragy
5	Vaishnavi Pradhan	9763169560	pradhanvaishnavi185@gmail.com	Vaishnavi
6	Shrushti Patil	7387067402	shrushtipatil@gmail.com	Shrushti
7	Mansi Chaudhari	7720088783	chaudharmansi921@gmail.com	Mansi
8	Rita Maity	7350980367	maityrita25@gmail.com	Rita
9	Prachi N. Laxkar	8806244419	Prachilaxkar159@gmail.com	Prachi
10	Tannu S. Korde	7841984450	kordetannu133@gmail.com	Tannu

Signature of:

Program In-charge

ICAC Coordinator
CO ORDINATOR
INTERNAL QUALITY ASSURANCE CELL
DHARAMPETH, M. P. DEO MEMORIAL S.
SCIENCE COLLEGE

PRINCIPAL
DHARAMPETH M. P. DEO
MEMORIAL SCIENCE COLLEGE
NAGPUR



DHARAMPETH M. P. DEO MEMORIAL SCIENCE COLLEGE,
North Ambazari Road, Near Ambazari Lake, Nagpur- 440033

DATA VALIDATION & VERIFICATION (DVV)

11	Archita A Maske	9975034151	maskearchita@gmail.com	Archita
12	Shalinam.T. madavi	9022302785	shalinammadavi.5@gmail.com	Shalinam
13	Pranavi Ghogadkar	9309079627	Pronavi02gh@gmail.com	Pranavi
14	Pallavi Katre	8459277408	Pratice573@gmail.com	Pallavi
15	Sujata Kawar	9175451202	Sujatakawar@gmail.com	Sujata
16	Bhagyashree Ambule	9359139068	ambuleb66@gmail.com	Bhagyashree
17	Majwari Mali	7498065023	Majwarimali18203@gmail.com	Majwari
18	Mahima Wankhede	7821883251	wankhede.mahima@gmail.com	Mahima
19	Vaishnavi Bahadure	9284679244	vaishnavibahadure2@gmail.com	Vaishnavi
20	Vaishnavi Upasak	9975287431	Upasakvaishnavi@gmail.com	Vaishnavi
21	Ananya Meghate	9284834439	ananyameghate@gmail.com	Ananya
22	Sushmita Mallick	983791650	sushmitta60@gmail.com	Sushmita
23	Vanshika Todase	9511744575	vanshika@gmail.com	Vanshika
24	Riya Sherkar	9249070278	sherkar.riya@gmail.com	Riya

Signature of:

Programme In-charge

CO-ORDINATOR
INTERNAL QUALITY ASSURANCE CELL
DHARAMPETH, M. P. DEO MEMORIAL &
SCIENCE COLLEGE, NAGPUR

PRINCIPAL
DHARAMPETH, M. P. DEO
MEMORIAL SCIENCE COLLEGE
NAGPUR

To,
The Principal,
Dharampeth M.P. Deo Memorial Science College
Nagpur.

Subject: - Permission for Visit to Production Facility of Renaissance Superfoods Pvt. Ltd.

Respected Sir,

This is to request you to grant permission for Visit to Production Facility of Renaissance Superfoods Pvt. Ltd. on 13.04.2023 for B.Sc. Home Science Semester IV Semester VI students, as a part of Certificate Course in Fundamentals of Food Preservation & Safety. Hope you grant us Permission for the above.

Thanking you

Yours Sincerely,

Meshpande
Head of Department
Department of Home Science
Dharampeth M.P. Deo Memorial
Science College, Nagpur

[Signature]

*University
safety Board.*



Dharampeth Education Society's
**DHARAMPETH M. P. DEO MEMORIAL
SCIENCE COLLEGE**

Near Ambazari Lake, North Ambazari Road, Nagpur - 440 033 (M.S.)
Contact: +91 712 2241372 / 2241490; Fax: +91 712 2241125
www.dharampethscience.edu
NAAC Accredited - A grade (3.01)

DR. AKHILESH V. PESHWE
M.A., M.Ed. (H.S.), U.S. Ph.D.
PRINCIPAL

Contact: +91 94223 13334
Email: principal_dsc@rediffmail.com

Letter No. : DSC/SR/IR/.....
To,

Date :

Mr. Swapnil Muley
Founder & CEO
Renaissance Superfoods Pvt. Ltd.
Ram Nagar,
Nagpur

Subject – Visit to the production facility of Renaissance Superfoods Pvt. Ltd

Sir,

We are conducting 'Certificate Course in Fundamentals of Food Preservation & Safety' for B.Sc. Home Science IInd year & IIIrd year students of our college.

We request you to kindly grant permission for a guided tour of your production facility on 13.04.2023 for the students to learn the practical application of the subject & to understand the process of food production at industrial level in real time.

Thanking you for your co-operation,

Yours sincerely,

12.04.2023
Nagpur

Principal
Dharampeth M. P. Deo Memorial Science College
Dharampeth M. P. Deo
MEMORIAL SCIENCE COLLEGE
NAGPUR

coordinator for this visit Dr. Meghana Pandit.

Renaissance Superfoods Pvt. Ltd.
Swapnil Muley
Director

Received
Swapnil Muley
Director

Director

Renaissance Superfoods Pvt. Ltd.



DHARAMPETH M. P. DEO MEMORIAL SCIENCE COLLEGE, NAGPUR
DEPARTMENT OF COMPUTER SCIENCE
ACADEMIC SESSION: 2022-23

NOTICE

08/04/2023

All the students of B.Sc.[SEM VI] are hereby informed that the Department of Computer Science, Dharampeth M.P.Deo Memorial Science College, Nagpur is going to organize a Quiz Competition of Trigger and Functions used in PL/SQL of Paper II [SQL and PL/SQL] on 15/04/2023. All the students must remain present and participate in this activity.

Venue: Computer Science laboratory

Principal
Dharampeth M. P. Deo Memorial
Science College, Nagpur

Head, Department of Computer Science

Head,
Department of Computer Science
Dharampeth M. P. Deo Memorial
Science College, Nagpur



DHARAMPETH M. P. DEO MEMORIAL SCIENCE COLLEGE, NAGPUR
INTERNAL QUALITY ASSURANCE CELL (IQAC)
NEP Activity Report

Date: 17/4/2023

Name of Organizing Department or Committee: Computer Science Department

Name of the activity: Quiz Competition

Suggested CRITERION point if any: Criteria V

Date of Activity: 15/4/2023

Place of Activity: Computer Science Laboratory

Name of Guest Speaker/s or Judge/s or Chief Guest/s if any: Nil

Title of the Activity: Trigger and Functions used in PL/SQL

Number of Participants: 31

Name of the Teacher In-charge / Convener: Dr. Mrs. Snehal Narale

Names of other Committee Members / Staff: Nil

OUTCOME of the Activity with respect to mission vision of the institute and or academics:

The main aim of this activity was to motivate the students to develop beyond their textual knowledge and make a connection between theory and application of the principles they have learned. With practicing quizzes, students can do critical thinking, and get into a habit of innovative learning. This activity helps the students to understand their weaker area from the specified topics.

After completion of this activity students get a better idea of how well they are grasping the material, hopefully motivating them to study more and helping them allocate their study time effectively by focusing on the specific topic of the competition that still needs more practice.

Activity with newspaper coverage if any: Nil

Activity data save in PC of: Dr. Mrs. Snehal Narale's Laptop

Dr. Mrs. Snehal Narale

Name & Signature of Teacher In-charge

Prof. Pitambar Humane

IQAC Coordinator
CO ORDINATOR

INTERNAL QUALITY ASSURANCE CELL
DHARAMPETH, M. P. DEO MEMORIAL &
SCIENCE COLLEGE, NAGPUR

Dr. Achillesh Peshwe

Principal
Principal

Dharampeth M. P. Deo Memorial
Science College, Nagpur



DHARAMPETH M. P. DEO MEMORIAL SCIENCE COLLEGE,
North Ambazari Road, Near Ambazari Lake, Nagpur-440033

DATA VALIDATION & VERIFICATION (DVV)

Name of the Programme : Quiz competition on Trigonometry [Sem 2]
Date of the Programme : 15th April 2023 Functions use in PL/SQL
Name of Chief Guest if any : _____
Name of Guest Speaker if any : _____

Sr. No.	Name of the Participant	Mobile Number	E-mail Id	Signature
1.	Bhargav D. Samudkar	7895458510	bhargavd1234@gmail.com	
2.	Diya R. Patil	7757052463	diyapatil553@gmail.com	
3.	Rushika S. Bhoyar	9523832686	rushikasbhoyar@gmail.com	
4.	Khushi Dade	9890009957	kd8571477@gmail.com	
5.	Sanj Rai	995889509	sanjrai123@gmail.com	
6.	Beema M. Lakda	7058728070	beemalakda123@gmail.com	
7.	Sujata Purnaf. Sawade	9021135140	sujatapurnaf123@gmail.com	
8.	Samiksha R. Khasare	9604173539	samikshar123@gmail.com	
9.	Dikshita P. Sahare	9028830801	dikshitasahare@gmail.com	
10.	Komal M. Kumbhare	7620314864	kombhar123@gmail.com	

Signature of

Programme In-charge

IGAC Coordinator
CO ORDINATOR
INTERNAL QUALITY ASSURANCE CELL
DHARAMPETH M. P. DEO MEMORIAL &

Principal
Dharampeth M. P. Deo Memorial
Science College, Nagpur



DHARAMPETH M. P. DEO MEMORIAL SCIENCE COLLEGE,
North Ambazari Road, Near Ambazari Lake, Nagpur-440033

DATA VALIDATION & VERIFICATION (DVV)

11.	Neha Bankar	8055477553	nehambankar@gmail.com	Bankar
12.	Tanvi Mahule	7057340888	tanvimahule@gmail.com	B Mahule
13.	Sanchit Joshi	8975706788	Sanchitjoshi@gmail.com	S Joshi
14.	Pranay Dhose	8055292863	pranayd@gnul.ac	P Dhose
15.	Akash Das	7972962799	akashd@gmail.com	Das & Co
16.	Prakash Khanna	801598643	prakash@gmail.com	Prakash
17.	Nikhil Jankar	8530960407	nikhiljankar@gmail.com	Jankar
18.	Tarun S. Godam	7262034206	tarunsgodam@gmail.com	T.S. Godam
19.	Ashish V. Ghosh	9404419055	ashishvghosh@gmail.com	Ashish
20.	Suresh Ghulekar	9021627757	sureshghulekar@gmail.com	S Ghulekar
20.2)	Abhishek A. Falke	7803835525	abhishekfalke@gmail.com	A Falke
21.	Sahil Jivade	9736414663	sahiljivade@gmail.com	Jivade
23.	Aditya Singh	7403208740	adityasingh22@gmail.com	Singh
24.	Vishal V. Gadhale	9673681472	vishalvghadhale@gmail.com	Gadhale
25.	Samiksha Taphane	9307135863	samikshataphane@gmail.com	Taphane
26.	Pooja Rajwade	868974021	poojarajwade@gmail.com	Rajwade

Signature of
[Signature]
Programme In-charge

[Signature]
IQAC Coordinator
CO ORDINATOR
INTERNAL QUALITY ASSURANCE CELL
DHARAMPETH M. P. DEO MEMORIAL SCIENCE COLLEGE

[Signature]
Principal
Dharampeth M. P. Deo Memorial
Science College, Nagpur



DHARAMPETH M. P. DEO MEMORIAL SCIENCE COLLEGE, NAGPUR
DEPARTMENT OF COMPUTER SCIENCE
ACADEMIC SESSION: 2022-23

NOTICE

10/4/2023

All the students of **B.Sc. [SEM VI]** are hereby informed that the Department of Computer Science, Dharampeth M.P.Deo Memorial Science College, Nagpur is going to One Day Workshop on Data Storage and Management in SQL using Sublanguages Commands [Unit I] of **Paper II[SQL and PL/SQL]** on **15/04 /2023** . All the students must remain present and participate in this activity.

Venue : Computer Science Laboratory

Principal
Dharampeth M. P. Deo Memorial
Science College, Nagpur

Head, Department of Computer Science
Head,

Department of Computer Science
Dharampeth M. P. Deo Memorial
Science College, Nagpur



DHARAMPETH M. P. DEO MEMORIAL SCIENCE COLLEGE, NAGPUR
INTERNAL QUALITY ASSURANCE CELL (IQAC)
NEP Activity Report

Date: 17th April 2023

Name of Organizing Department or Committee: Computer Science Department

Name of the activity: Workshop

Suggested CRITERION point if any: Criteria II, V

Date of Activity: 15/04/2023

Place of Activity: Computer Science Laboratory

Name of Guest Speaker/s or Judge/s or Chief Guest/s if any: Nil

Title of the Activity: Data Storage and Management in SQL using Sublanguages Command for students of SEM VI [Unit I : Paper II]

Number of Participants: 43

Name of the Teacher In-charge / Convener: Dr.Mrs.Snehal Narale

Names of other Committee Members / Staff: Nil

OUTCOME of the Activity with respect to mission vision of the institute and or academics:

The objective of this activity was to create awareness amongst the students with respect to the working process of storage of data and its management in SQL. After completion of this workshop students will be able to create their databases and store data in it. Data base plays an vital role while design and development of any software or application. This workshop helps them to clear their ideas regarding storage and management of the data by performing various operations on it. SQL is query-based language and students understood how the data is stored and perform operations on it using various commands used in SQL. This workshop provides a platform through which they can their ideas with other students on the topic.

Activity with newspaper coverage if any: Nil

Activity data save in PC of: Dr. Mrs. Snehal Narale's Laptop



Prof. Pitambar Humane
IQAC Coordinator
CO ORDINATOR
INTERNAL QUALITY ASSURANCE CELL
DHARAMPETH, M. P. DEO MEMORIAL &
SCIENCE COLLEGE, NAGPUR

Dr. Mrs. Snehal Narale
Name & Signature of Teacher In-charge

Dr. Arhilosh Peshwe
Principal
Principal
Dharampeth M. P. Deo Memorial
Science College, Nagpur



DATA VALIDATION & VERIFICATION (DVV)

Name of the Programme : Workshop on Data Storage and management in SQL using
Date of the Programme : 15/4/2023 Sublanguages
Name of Chief Guest if any : _____ Command
Name of Guest Speaker if any : _____

Sr. No.	Name of the Participant	Mobile Number	E-mail Id	Signature
1.	Dikshita P. Sahaie	9025830802	dikshita@ahaie@gmail.com	Dikshita
2.	Samiksha R. Khasare	9604473539	rekha.khasare@gmail.com	Samiksha
3.	BHAVESH R. MASKE	7489961631	bhavesh.maske2002@gmail.com	Bhavesh M.
4.	Sakshi S. Huddast	9405142450	wubainmahal@gmail.com	Sakshi
5.	Riddhi A. Rajkare	7668974021	riddhi.rajkare@gmail.com	Riddhi
6.	Sumit Shetkar	991627357	sumitshetkar123@gmail.com	S. Shetkar
7.	Preraj S. Das	9850129245	prerajdas17@gmail.com	Preraj
8.	Akash D. Das	7972942799	akashddas@gmail.com	Akash D.
9.	Sanhit Joshi	8975406788	sanhit.joshi@gmail.com	Sanhit
10.	Abhishek A. Falke	7823835535	abhishekfalke001@gmail.com	Abhishek

Signature of:
Preraj S. Das
Programme In-charge

Sumit Shetkar
IQAC Coordinator

INTERNAL QUALITY ASSURANCE CELL
DHARAMPETH M. P. DEO MEMORIAL &
SCIENCE COLLEGE, NAGPUR

Preraj S. Das
Principal

Dharampeth M. P. Deo Memorial
Science College, Nagpur



DHARAMPETH M. P. DEO MEMORIAL SCIENCE COLLEGE,
North Ambazari Road, Near Ambazari Lake, Nagpur - 440033

DATA VALIDATION & VERIFICATION (DVV)

11.	Bhawesh D. Mathur	9021317056	bhaweshmathur31912003@gmail.com	
12.	Tanuj R. Guke	9422488044	tanujguker2001@gmail.com	
13.	Sarekh V. Rowd	9527283213	sarekhvullikar3@gmail.com	
14.	Pradmesh S. Badhe	9765262138	Pradmeshbadhe19@gmail.com	
15.	Vijay V. Gishalle	967261478	Vijayvijaygishalle@gmail.com	
16.	Rishikesh R. Datta	8788199260	rishikeshdatta2002@gmail.com	
17.	Diya R. Patil	7759052463	diyapatil553@gmail.com	
18.	Pranjal D. Sawarkar	7385458510	pranjalbawar1234@gmail.com	
19.	Amali B. Singh	7709208740	Amalibinghi222@gmail.com	
20.	Pratham M. Sonar	8275451976	Prathamsonar1234@gmail.com	
21.	Khushti A. Gupta	9922997235	kg0289200@gmail.com	
22.	Mukund Hood	9604485822	mukundhood1234@gmail.com	
23.	Rajat Rahad	9175635243	Rajalrahad413@gmail.com	
24.	Komal Kumbhkar	7620314869	KombhkarKomal24@gmail.com	
25.	Tanu Mahule	7057844882	tanumahule615@gmail.com	
26.	Samiksha Tadhane	9907138863	Samikshatadhane@gmail.com	

Signature of:

Programme In-charge

CIDAC Coordinator

INTERNAL QUALITY ASSURANCE CELL
DHARAMPETH M. P. DEO MEMORIAL &

Principal

Dharampeth M. P. Deo Memorial
Science College, Nagpur



DHARAMPETH M. P. DEO MEMORIAL SCIENCE COLLEGE,
North Ambazari Road, Near Ambazari Lake, Nagpur - 440033

DATA VALIDATION & VERIFICATION (DVV)

21.	Soni A. Rai	9855999109	soniamail3@gmail.com	<u>Soni</u>
28.	Sahil P. Jirkade	9534114543	sahiljirkade@yahoo.com	<u>Sahil</u>
29.	Neha S. Bankar	8055477553	nehazoo2bankar@gmail.com	<u>Bankar</u>
30.	Tarunay S. Gudam	7767034396	tarunay.gudam1@gmail.com	<u>T.S.Gudam</u>
31.	Paatikha S. Chaudhari	7801317699	chaatikha.paatikha@gmail.com	<u>Paatikha</u>
32.	Ruchika S. Bhayav	9527432686	ruchika.s.bhayav@gmail.com	<u>Ruchika</u>
33.	Khushi Dase	9890009937	khushi1411@gmail.com	<u>Khushi</u>
34.	Nikhil Tjankar	8530360407	nikhil.tjankar@gmail.com	<u>Nikhil</u>
35.	Pranay Mahajan	7328551492	Pranaymahajan@gmail.com	<u>Pranay</u>
36.	Mahesh. Maske	9021951173	maheshmaske48@gmail.com	<u>Maske</u>
37.	Rajit Roshad	9175675272	RajitRoshad@gmail.com	<u>Rajit</u>
38.	Atthav Gishre	9404419055	atthavgishre@gmail.com	<u>Atthav</u>
39.	Abdul Raaf Aman Shafigue	7666938579	raafkaman2811@gmail.com	<u>Raaf</u>
40.	Ritu Lalit Chaudhary	8180962189	ritulalit.chaudhary@gmail.com	<u>Ritu</u>
41.	Sejanta Pharnraj Sonawane	9021135140	sejantasonawane2001@gmail.com	<u>Sejanta</u>
42.	Aarti. B. Singh	7703208740	AartiBSingh022@gmail.com	<u>Singh</u>

Signature of:

Prasanna
Programme in-charge

Prasanna
IQC Coordinator

INTERNAL QUALITY ASSURANCE CELL
DHARAMPETH M. P. DEO MEMORIAL &
SCIENCE COLLEGE, NAGPUR

Prasanna
Principal

Dharampeth M. P. Deo Memorial
Science College, Nagpur



DHARAMPETH M. P. DEO MEMORIAL SCIENCE COLLEGE, NAGPUR
DEPARTMENT OF COMPUTER SCIENCE
ACADEMIC SESSION: 2022-2023

NOTICE

8/04/2023

All the students of B.Sc. SEM [IV] are hereby informed that the Department of Computer Science, Dharampeth M.P. Deo Memorial Science College, Nagpur is going to organize **Power Point Activity on VI editor in Linux Unit IV [Paper II] 17/04/2023**. All the students must remain present and participate in this activity.

Venue : Computer Science Laboratory

Dr. Mrs. Shehal Narale
Head, Department of Computer Science

Dr. Akhilesh Peshwe
Principal
Principal
Dharampeth M. P. Deo Memorial
Science College, Nagpur



DHARAMPETH M. P. DEO MEMORIAL SCIENCE COLLEGE, NAGPUR
INTERNAL QUALITY ASSURANCE CELL (IQAC)

NEP Activity Report

Date: 18th April 2023

Name of Organizing Department or Committee: Computer Science Department

Name of the activity: Power Point Presentation Activity/Competition

Suggested CRITERION point if any: Criteria V

Date of Activity: 17/04/2023

Place of Activity: Computer Science laboratory

Name of Guest Speaker/s or Judge/s or Chief Guest/s if any: Nil

Title of the Activity: Power Point Presentation Activity/Competition on Function of Unit II SEM IV Paper II [Linux Operating System]

Number of Participants: 28

Name of the Teacher In-charge / Convener: Dr.Mrs.Snehal Narale

Names of other Committee Members / Staff: Nil

OUTCOME of the Activity with respect to mission vision of the institute and or academics:

The main objective of this activity to create sparks and curiosity in their mind related to the topic of their presentation from their syllabus.

- Conduction of Such activity helps the students to present their information in multiple ways (a multimodal approach) through the projection of color, images, and video for the visual mode.
- Students will be able to explore their ideas about the topic from their curriculum.
- It also helps to enhance their basic subject knowledge.
- Students will be able to enhance their intellect.
- Students learn the new as well as syllabus contents information in quicker as compare to the traditional methods.
- It also helps them to write better answers in their exams
- Students will be able to understand hoe to develop job skills in them for their better future prospects..

Activity with newspaper coverage if any: Nil

Activity data save in PC of: Dr. Mrs. Snehal Narale's Laptop

Prof.Pitambar Humane
IQAC Coordinator

CO ORDINATOR
INTERNAL QUALITY ASSURANCE CELL
DHARAMPETH, M. P. DEO MEMORIAL &
SCIENCE COLLEGE, NAGPUR

Dr.Mrs.Snehal Narale
Name &Signature of Teacher In-charge

Dr.Akhilesh Peshwe
Principal

Principal
Dharampeth M. P. Deo Memorial
Science College, Nagpur



DHARAMPETH M. P. DEO MEMORIAL SCIENCE COLLEGE,
North Ambazari Road, Near Ambazari Lake, Nagpur- 440033

DATA VALIDATION & VERIFICATION (DVV)

Name of the Programme : Activity
Power point presentation [sem IV]
Date of the Programme : 17/4/2023
Name of Chief Guest if any : _____
Name of Guest Speaker if any : _____

Sr. No.	Name of the Participant	Mobile Number	E-mail Id	Signature
1.	Shraddha . S. Patil.	7218039074	shraddhapatil2003@gmail.com	
2.	Aditi Kute.	7620812303	aditilute21@gmail.com	
3.	Krunal G. Palmit	8988700782	Krunalboopalmit14@gmail.com	
4.	Rishi K. Bisen	7028810840	rishubisen06@gmail.com	
5.	Shubh Bedwal	8092492194	shubhbedwal2000@gmail.com	
6.	Mansi Nandanwar	7709322027	mansinandanwar1@gmail.com	
7.	Adityakumar Shukla	9518994638	adityashukla0025@gmail.com	
8.	Hitesh - G. Kawase	7058427112	hiteshkawase7@gmail.com	
9.	Jay Anilbhai Patil	7385436956	jay.patil@0326@gmail.com	
10.	Nitin A' Kulkarni	9688428005	nitinkulkarni706@gmail.com	

Signature of:

Programme In-charge

IQAC Coordinator
CO ORDINATOR
INTERNAL QUALITY ASSURANCE CELL
DHARAMPETH M. P. DEO MEMORIAL &

Principal
Dharampeth M. P. Deo Memorial
Science College, Nagpur



DHARAMPETH M. P. DEO MEMORIAL SCIENCE COLLEGE,
North Ambazari Road, Near Ambazari Lake, Nagpur-440033

DATA VALIDATION & VERIFICATION (DVV)

11.	Anuj H. Mishra	8103656208	anujmishra251202@gmail.com	Anuj M.
12.	Khushbu G. Walmik	8983700782	khushbuwalmik14@gmail.com	Khushbu
13.	Nutan Surjuse	8805570279	nutansurjuse2@gmail.com	Surjuse
14.	Damini Katee	8208255685	daminiKatee91@gmail.com	Damini
15.	Devishruti Jadhav	9156916355	030806399@gmail.com	Devishruti
16.	Vicky Singh	9836782331	vickysingh11032001@gmail.com	Vicky
17.	Suman Singh	9322018536	sumansingh12112001@gmail.com	Suman
18.	Aditya Kumar Singh	7350543301	adityaSingh288190@gmail.com	A.K.S
19.	Hritik C. Mishra	9067645755	Kamranurkhan1010@gmail.com	Hritik
20.	Amkumar D. Desai	9963624988	amkumar122@gmail.com	Amkumar
21.	Poojesh S. Naikar	7438033428	poojeshnaikar@gmail.com	Poojesh
22.	Arishkar A. Bansod	720841788	arishkarbansod02@gmail.com	A. A. Bansod
23.	Kaashal N. Ajankar	9527732348	kaashalajankar@gmail.com	K. N. Ajankar
24.	Isha S. Nemade	7028494761	ishanemade72@gmail.com	Ishane
25.	Semir V. Sabale	9322410288	SemirSabale129@gmail.com	Semir
26.	Ankur Khurpadi	7243991620	Khurpadiankur@gmail.com	Ankur

Signature of:

Ronak

Programme In-charge

[Signature]
IQAC Coordinator
CO ORDINATOR

INTERNAL QUALITY ASSURANCE CELL
DHARAMPETH, M. P. DEO MEMORIAL &
SCIENCE COLLEGE, NAGPUR

[Signature]
Principal

Dharampeth M. P. Deo Memorial
Science College, Nagpur



DHARAMPETH M. P. DEO MEMORIAL SCIENCE COLLEGE, NAGPUR
INTERNAL QUALITY ASSURANCE CELL (IQAC)

NEP Activity Report

Date: 20/04/2023

Name of Organizing Department or Committee: Chemistry Department

Name of the activity: NEP Activity Report (Sem- IV, Unit-IV)

Suggested CRITERION point if any: Criteria II

Date of Activity: 18/04/2023

Place of Activity: Chemistry Department Laboratory

Name of Guest Speaker/s or Judge/s or Chief Guest/s if any: Nil

Title of the Activity: Water Sampling and its analysis

Number of Participants: 35

Name of the Teacher In-charge / Convener: Ms. Niharika A. Sute

Names of other Committee Members / Staff: Dr. Vaishali Meshram

OUTCOME of the Activity with respect to mission vision of the institute and or academics:

This is student centric activity. In this activity Various Water samples are collected from different areas & different sources of Nagpur city. These water samples analysed for various physico-chemical properties.

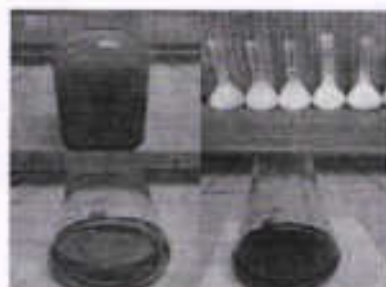

Activity with newspaper coverage if any: Nil

Activity data save in PC of: Chemistry Department

Note: Kindly share geotag photographs separately along with report on iqacdsc2022@gmail.com

Prof. Pitambar Humane
IQAC Coordinator

CO ORDINATOR
INTERNAL QUALITY ASSURANCE CELL
DHARAMPETH, M. P. DEO MEMORIAL &
SCIENCE COLLEGE, NAGPUR

(Niharika A. Sute)
Name & Signature of Teacher In-charge

Dr. Akhilesh Peshwe
Principal

PRINCIPAL
Dharampeth M.P. Deo Memorial
Science College, Nagpur-440033

5



DHARAMPETH M. P. DEO MEMORIAL SCIENCE COLLEGE,
North Ambazari Road, Near Ambazari Lake, Nagpur- 440033

DATA VALIDATION & VERIFICATION (DVV)

NEP Activity on unit-IV, paper-I (Sem-IV)
 Name of the Programme : water sampling and its analysis
 Date of the Programme : 18/04/2023
 Name of Chief Guest if any : -
 Name of Guest Speaker if any : -

Sr. No.	Name of the Participant	Mobile Number	E-mail Id	Signature
1	Shrawani R. Warkhede	7058368834	shrawanirwarkhede@nagpur.ac.in	
2	Anjali Mishra	9325604513	anjalmishra4956@gmail.com	
3	Dhanshree Y. Newalkar	9356516280	newalkerdhanshree@gmail.com	
4	Twinkal Lokhunde	8199176609	twinkallokunde@gmail.com	
5	Rupesh Bhokre	8805887370	Bhokre Rupesh@gmail.com	
6	Pooja Itanker	9156973252	poojitanker087@gmail.com	
7	Vaishnavi Lakhe	8663594864	vaishnavilakhe@gmail.com	
8	Urmila V. Bondar	9990643867	bondarurmila2000@gmail.com	
9	Shraddha Dhawale	8888264004	shradhdhawale124@gmail.com	
10	Vaibhavi Shende	80802640982	vaibhavishende97@gmail.com	

Signature of:

Programme In-charge
(Niharika A. Sute)

IQAC Coordinator
CO ORDINATOR
 INTERNAL QUALITY ASSURANCE CELL
 DHARAMPETH, M. P. DEO MEMORIAL &
 SCIENCE COLLEGE, NAGPUR

Principal
PRINCIPAL
 Dharampeth M. P. Deo Memorial
 Science College, Nagpur-440033



DHARAMPETH M. P. DEO MEMORIAL SCIENCE COLLEGE,
North Ambazari Road, Near Ambazari Lake, Nagpur- 440033

DATA VALIDATION & VERIFICATION (DVV)

11)	Tina Rahangdale	9921776769	tina rahangdale@gmail.com	Tina
12)	Chhakuli Wadkar	9325047907	chhakuliwadkar@gmail.com	Chhakuli
13)	Mansi Raut	7385119331	mansiraut46@gmail.com	Mansi
14)	Vaishnavi Gadge	9022976449	gadgavaishnavi00@gmail.com	Gadge
15)	Pragyaal Bhojwar	8010434634	pragyaal6735@gmail.com	Pragyaal
16)	Gaungi Hodge	7972076671	gaunghodge@gmail.com	Gaungi
17)	Kajal Prasad	7410763138	prasadkajal2004@gmail.com	Prasad
18)	Riya Pandit	9370616353	panditriya753@gmail.com	Riya
19)	Mansi Badale	7796308467	badalemans@gmail.com	Mansi
20)	Mansi Raut - Fatima	8767154686	mansiraut2110@gmail.com	Mansi
21)	Nidhi K. Misra	8805917268	nidhimisra2005@gmail.com	Nidhi
22)	Jasraj Paliwal	9370820325	jasrajpaliwal42@gmail.com	Jasraj
23)	Tejas Rewade	7796027056	tejasrewade86@gmail.com	Tejas
24)	Siddharth G. Mishra	9579092931	mishrasiddharth@gmail.com	Siddharth
25)	Jyoti Sharma	8664736380	jyotis8390@gmail.com	J. Sharma
26)	Sania Midhat Raza	8975726700	midhatania@gmail.com	Sania

Signature of:

Programme In-charge

(Mihareika A. Sute)

IQAC Coordinator

CO ORDINATOR

INTERNAL QUALITY ASSURANCE CELL
DHARAMPETH M. P. DEO MEMORIAL &
SCIENCE COLLEGE, NAGPUR

Principal

PRINCIPAL

Dharampeth M. P. Deo Memorial
Science College, Nagpur-440033



DHARAMPETH M. P. DEO MEMORIAL SCIENCE COLLEGE,
North Ambazari Road, Near Ambazari Lake, Nagpur- 440033

DATA VALIDATION & VERIFICATION (DVV)

27)	AMAN. A. DONGRE	7709217312	amandongre2003@gmail.com	<u>Amangre</u>
28)	Darshana S. Madavi	8830146590	darshnamadavi@gmail.com	<u>Darshana</u>
29)	Vaishnavi Nandpuri	9322489310	vaishnavinandpuri@gmail.com	<u>Vaishna</u>
28)	Vaishnavi J. Bedate	8830107399	vaishnavibedate@gmail.com	VB
30)	Kalpna Sahagpure	9579236712	kalpanasahagpure@gmail.com	<u>Kalpna</u>
32)	Juhi S. Chaudhari	8669248944	chaudharijuhi20@gmail.com	<u>Juhi</u>
33)	Mansi T. Mate	846891807	mansi1912@gmail.com	<u>Mansate</u>
33)	Sakshi S. Meshram	9145355733	sakshimeshram210@gmail.com	<u>Sakshi</u>
34)	Jagndi D. Warkar	7447366023	jagndiwarkar@gmail.com	<u>J.D. Warkar</u>
35)	Niket Thakur	7378899087	Niketthakur@gmail.com	<u>N. Thakur</u>

Signature of:

Programme In-charge

(Mihesika A. Sute)

IQAC Coordinator

CO ORDINATOR

INTERNAL QUALITY ASSURANCE CELL
DHARAMPETH M. P. DEO MEMORIAL &
SCIENCE COLLEGE, NAGPUR

Principal
PRINCIPAL

Dharampeth M.P. Deo Memorial
Science College, Nagpur-440033



DHARAMPETH M. P. DEO MEMORIAL SCIENCE COLLEGE, NAGPUR
DEPARTMENT OF COMPUTER SCIENCE
ACADEMIC SESSION: 2022-2023

NOTICE

14/04/2023

All the students of **B.Sc. SEM [IV]** are hereby informed that the Department of Computer Science, Dharampeth M.P.Deo Memorial Science College, Nagpur is going to organize **"One Day Workshop on Linux(Kali) Installation and Execution of Commands on it"** in Linux Unit I [Paper II] 24/4/2023. All the students must remain present and participate in this activity.

Venue : Computer Science Laboratory

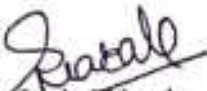
Dr. Mrs. Srichal Narale
Head, Department of Computer Science
Head,
Department of Computer Science,
Dharampeth M. P. Deo Memorial
Science College, Nagpur

Dr. Akhilesh Peshwe
Principal
Principal
Dharampeth M.P. Deo Memorial
Science College, Nagpur.



DHARAMPETH M. P. DEO MEMORIAL SCIENCE COLLEGE, NAGPUR
INTERNAL QUALITY ASSURANCE CELL (IQAC)
NEP Activity Report

Date: 30th April 2023

Name of Organizing Department or Committee: Computer Science Department

Name of the activity: One Day Workshop

Suggested CRITERION point if any: Criteria II, V

Date of Activity: 24/04/2023

Place of Activity: Computer Science laboratory

Name of Guest Speaker/s or Judge/s or Chief Guest/s if any: Nil

Title of the Activity: Linux (Kali) Installation and Execution of Commands on it) of Unit I
SEM IV Paper II [Linux Operating System]

Number of Participants: 30

Name of the Teacher In-charge / Convener: Dr. Mrs. Snehal Narale

Names of other Committee Members / Staff: Nil

OUTCOME of the Activity with respect to mission vision of the institute and or academics:

The main objectives of this activity to provide platform to the students to create a space in which a group of students can be able to discuss on the topics, brainstorm ideas, identify problems, make decisions and develop solutions. In the workshop the faculty discuss the following topics:

- What is Kali Linux with its Definition.
- Installation Process
- The use and task of Kali
- Working of Kali
- Applications of Kali Interface
- Advantages and Disadvantages of Kali

At the end of this workshop students will be able to understand what is Kali interface and how it is different from the other interfaces.

Activity with newspaper coverage if any: Nil

Activity data save in PC of: Dr. Mrs. Snehal Narale's Laptop

Prof. Pitambar Humane
IQAC Coordinator
CO ORDINATOR
INTERNAL QUALITY ASSURANCE CELL
DHARAMPETH, M. P. DEO MEMORIAL &
SCIENCE COLLEGE, NAGPUR

Dr. Mrs. Snehal Narale
Head Teacher In-charge
Department of Computer Science
Dharampeth M. P. Deo Memorial
Science College, Nagpur

Dr. Akhilesh Peshwe
Principal
Dharampeth M.P. Deo Memorial
Science College, Nagpur.



DHARAMPETH M. P. DEO MEMORIAL SCIENCE COLLEGE,
North Ambazari Road, Near Ambazari Lake, Nagpur- 440033

DATA VALIDATION & VERIFICATION (DVV)

Name of the Programme : One day workshop on Linux(Kali) [Sem IV]
 Date of the Programme : 28/4/2023
 Name of Chief Guest if any : _____
 Name of Guest Speaker if any : _____

Sr. No.	Name of the Participant	Mobile Number	E-mail Id	Signature
1.	Pragnyashree S. Thakare	8766925275	prabrebbhagyashtakare@gmail.com	B.Thakare
2.	Aditi Lute	7820812303	aditilute191@gmail.com	Aditi
3.	Nutan Sujuse	8805540279	nutansujuse2@gmail.com	Sujuse
4.	Jay Amilbhai Patil	7385436956	jay.patil0326@gmail.com	Jay P.
5.	Nitin Ajay Keshwaha	963698969342905	nitinkeshwaha4063@gmail.com	Nitin
6.	Adityakumar Bhukta	8518934638	adityashukla0025@gmail.com	Bhukta
7.	Arishka Anil Bansod	7820841788	arishkabansod02@gmail.com	A. P. Bansod
8.	Ritul K. Bisen	7028810540	ritulbisen06@gmail.com	R. Bisen
9.	Ketan Bhoyare	9657357276	ketanbhoyare@gmail.com	K.B
10.	Harshad Ajan Kar	9527732348	Harshadajankar2@gmail.com	Harshad

Signature of:

[Signature]

Programme In-charge
Head,

Department of Computer Science
Dharampeth M. P. Deo Memorial
Science College, Nagpur

[Signature]

IQAC Coordinator
CO ORDINATOR

INTERNAL QUALITY ASSURANCE CELL
DHARAMPETH, M. P. DEO MEMORIAL &
SCIENCE COLLEGE, NAGPUR

[Signature]

Principal

Dharampeth M. P. Deo Memorial
Science College, Nagpur



DHARAMPETH M. P. DEO MEMORIAL SCIENCE COLLEGE,
North Ambazari Road, Near Ambazari Lake, Nagpur- 440033

DATA VALIDATION & VERIFICATION (DVV)

11.	Isha Nemade	7028494761	ishanemade.72@gmail.com	<i>Ishane</i>
12.	Rahul Kawade	9359525716	kawadechuloh2@gmail.com	<i>Rahul</i>
13.	Uinatitai Chopde	9822627677	uinatitai.chopde@gmail.com	<i>Uinatitai</i>
14.	Mansi Nandanwar	7709322027	mansinandanwar@gmail.com	<i>Mansi</i>
15.	Saurav Wikey	9356088871	sauravwikey5@gmail.com	<i>Saurav</i>
16.	Ankush Gowade	7536194156	ankushg56@gmail.com	<i>Ankush</i>
17.	Yash Khedekar	7070929422	yashkhedekar5@gmail.com	<i>Yash</i>
18.	Sumit V. Sable	9357200388	sumitsable1923@gmail.com	<i>Sumit</i>
19.	Bhagwati Pandey	3175302601	pandeybhagwati@gmail.com	<i>Bhagwati</i>
20.	Urvashi Umathe	8177979299	urvashiumathe@gmail.com	<i>Urvashi</i>
21.	Sakshi V. Kanade	8806934839	sakshikanade32@gmail.com	<i>Sakshi</i>
22.	Shruti Bedal	8090440144	shrutibedal26@gmail.com	<i>Shruti</i>
23.	Santosh Sakhare	8605710878	santoshsakhare@gmail.com	<i>Santosh</i>
24.	SAYIL SINGH	7258768502	sahil Singh 08@gmail.com	<i>Sahil</i>
25.	Sanchita S. Patil	7218079014	sanchitapatil2003@gmail.com	<i>Sanchita</i>
26.	Darshini B. Katre	8208256085	darshinikatre31@gmail.com	<i>Darshini</i>

Signature of

Patil
Programme In-charge

Department of Computer Science,
Dharampeth M. P. Deo Memorial
Science College, Nagpur

IQAC Coordinator

CO ORDINATOR
INTERNAL QUALITY ASSURANCE CELL
DHARAMPETH, M. P. DEO MEMORIAL &
SCIENCE COLLEGE, NAGPUR

Principal

Principal
Dharampeth M. P. Deo Memorial
Science College, Nagpur



DHARAMPETH M. P. DEO MEMORIAL SCIENCE COLLEGE, NAGPUR
INTERNAL QUALITY ASSURANCE CELL (IQAC)

Activity Report

Date: 26.04.2023

Name of Organizing Department or Committee: Dept of Home Science

Name of the activity: Guest Lecture on ' Role of FSSAI & Career Opportunities in Food Safety'

Suggested CRITERION point if any:

Date of Activity: 26.04.2023

Place of Activity: Online

Name of Guest Speaker/s or Judge/s or Chief Guest/s-if any: Dr. Asmita Thaokar

Title of the Activity: Guest Lecture on ' Role of FSSAI & Career Opportunities in Food Safety'

Number of Participants: 22

Name of the Teacher In-charge / Convener: Mrs. Meghna Pandit

Names of other Committee Members / Staff:

OUTCOME of the Activity with respect to mission vision of the institute and or academics:

To develop understanding about the role of FSSAI in food industry and explore further education & career opportunities in food safety sector.

Activity with newspaper coverage if any: NA

Activity data save in PC of: Home Science Department Desktop

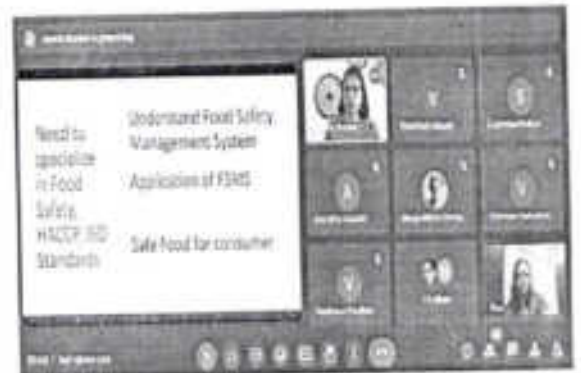
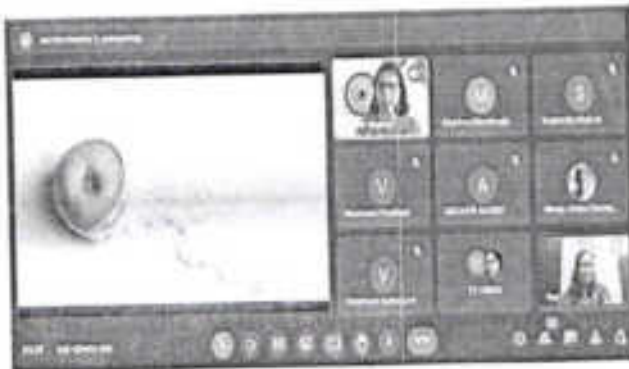

Prof. Pitambar Humane
CO-ORDINATOR
INTERNAL QUALITY ASSURANCE CELL
DHARAMPETH, M. P. DEO MEMORIAL &
SCIENCE COLLEGE, NAGPUR

Name & Signature of Teacher In-charge
(Mrs. Meghna Pandit)

Dr. Akhilesh Peshwe
Principal
DHARAMPETH M. P. DEO
MEMORIAL SCIENCE COLLEGE
NAGPUR

DHARAMPETH M.P. DEO MEMORIAL SCIENCE COLLEGE

DEPT. OF HOME SCIENCE

GUEST LECTURE * ROLE OF FSSAI & CAREER OPPORTUNITIES IN FOOD SAFETY

GUEST SPEAKER - DR. ASMITA THAKAR

DATE - 26.04.2023

S.No.	Name	Email ID	Phone Number
1	Archita Maske	maskearchita@gmail.com	9975034151
2	Avani Shenwai	avanishenwai1520@gmail.com	9096507459
3	Kajal pramod lokhande	lokhandekajal399@gmail	9322200238
4	Pallavi Balram katre	katrep024@gmail.com	8459277408
5	Pragya Tiwari	pragyatiwari14052003@gmail.com	916394098386
6	Prajakta Ashok Wakde	prajaktawakde148@gmail.com	8459413596
7	Priya Kashinath Khawshi	priyakhawshi3@gmail.com	9763617224
8	Riya uttam malye	Malyeriya23@gmail.com	7350980367
9	Shabnam madavi	shabnammadavi5@gmail.com	9022302785
10	Shrushti Patekar	shrushtipatekar@gmail.com	917387067403
11	Tannu Shailesh Korde	kordetannu139@gmail.com	7841954450
12	Vaishnavi Pradhan	pradhanvaishnavi155@gmail.com	9763169560
13	Ananya Meghare	ananyameghare@gmail.com	9284834439
14	Arohi Prashant Ramteke	arohiramteke7@gmail.com	8983345716
15	Mayuri Ganesh Mali	pushpamali1974@gmail.com	7498065023
16	Pranali Raut	Pranaliraut567@gmail.com	9130117015
17	Riya Prakash Sherekar	sherekar04riya@gmail.com	7249070278
18	Sakshi Thosar	sakshithosar620@gmail.com	8177911360
19	Sushmita Ganesh Mallick	sushmmi760@gmail.com	9337916560
20	Vaishnavi bahadure	vaishnavibahadure34@gmil.com	9284679244
21	Vaishnavi Upasak	upasakvaishnavi@gmail.com	9975287431
22	Vanshika Todase	vanshikatodase@gmail.com	9511744575

M. Pandit
Teacher-In-Charge

(Mrs Meghna Pandit)

Dr. Asmita Thakar
IQAC Co-ordinator

CO ORDINATOR
INTERNAL QUALITY ASSURANCE CELL
DHARAMPETH, M. P. DEO MEMORIAL &
SCIENCE COLLEGE, NAGPUR

Dr. Asmita Thakar
Principal
PRINCIPAL
DHARAMPETH M.P. DEO
MEMORIAL SCIENCE COLLEGE
NAGPUR